



CANADIAN COMMISSION ON
BUILDING AND FIRE CODES



ENERGY

●●● National Energy Code of Canada for Buildings 2020



National Research
Council Canada

Conseil national de
recherches Canada

Canada 

National Energy Code of Canada for Buildings 2020

**Issued by the
Canadian Commission on Building and Fire Codes
National Research Council of Canada**

This publication was made possible with the technical
and financial support of:



Natural Resources
Canada

Ressources naturelles
Canada

First Edition 1997
Second Edition 2011
Third Edition 2015
Fourth Edition 2017
Fifth Edition 2020

NRCC-CONST-56438E

© His Majesty the King in Right of Canada, as represented by
the National Research Council of Canada, 2025

Paper: ISBN 978-0-660-37921-0 Cat. No. NR24-24/2020E
PDF: ISBN 978-0-660-37920-3 Cat. No. NR24-24/2020E-PDF

Printed in Canada

Second Printing
Includes Revisions and Errata released in February 2025.

Aussi disponible en français :

Code national de l'énergie pour les bâtiments – Canada 2020
NRCC-CONST-56438F
Papier : ISBN 978-0-660-37923-4
PDF : ISBN 978-0-660-37922-7

Table of Contents

Preface

Relationship of the NECB to Standards Development and Conformity Assessment

Canadian Commission on Building and Fire Codes and Standing Committees

Revisions and Errata

Division A Compliance, Objectives and Functional Statements

- Part 1 Compliance
- Part 2 Objectives
- Part 3 Functional Statements

Division B Acceptable Solutions

- Part 1 General
- Part 2 Reserved
- Part 3 Building Envelope
- Part 4 Lighting
- Part 5 Heating, Ventilating and Air-conditioning Systems
- Part 6 Service Water Systems
- Part 7 Electrical Power Systems and Motors
- Part 8 Building Energy Performance Compliance Path
- Part 9 Reserved
- Part 10 Tiered Building Energy Performance Compliance

Climatic Information for Building Design in Canada

Division C Administrative Provisions

- Part 1 General
- Part 2 Administrative Provisions

Index

Preface

The National Energy Code of Canada for Buildings 2020 (NECB), together with the National Building Code of Canada 2020 (NBC), the National Plumbing Code of Canada 2020 (NPC) and the National Fire Code of Canada 2020 (NFC), was developed by the Canadian Commission on Building and Fire Codes (CCBFC) as an objective-based national model code that can be adopted by provincial and territorial governments.

In Canada, provincial and territorial governments have the authority to enact legislation that regulates building design and construction within their jurisdictions. This may involve the adoption of the NECB without change or with modifications to suit local needs, and the enactment of other laws and regulations regarding building design and construction, including requirements for professional involvement.

The NECB is a model code in the sense that it helps promote consistency among provincial and territorial energy codes for buildings. Persons involved in the design or construction of a building should consult the provincial or territorial jurisdiction concerned to find out which energy code is applicable.

This edition of the NECB succeeds the 2017 edition.

The development of the NECB 2020 was supported by the National Research Council of Canada (NRC), Natural Resources Canada and other stakeholders. The NECB 2020 will help to improve the energy efficiency of new buildings and reduce greenhouse gas emissions, contributing to long-term benefits for both Canada's economy and the environment.

Development of the National Model Codes

GOVERNANCE CHANGE NOTE: The national code development system underwent a governance change in November 2022 to support efforts to harmonize construction codes in jurisdictions throughout Canada. The CCBFC, which had been in place since 1991, was dissolved and replaced by a new governance model in which the Canadian Board for Harmonized Construction Codes (CBHCC) is responsible for developing, approving and maintaining the National Model Codes based on the strategic priorities set by the Canadian Table for Harmonized Construction Codes Policy. The 2020 National Model Codes were developed by the CCBFC. In this section, references to the CCBFC are written in the past tense to reflect the change in governance.

The CCBFC, an independent committee established by the NRC, was responsible for the content of the 2020 editions of the National Model Codes. The CCBFC was made up of volunteers from across the country and from all facets of the Codes-user community. Members of the CCBFC and its standing committees included builders, engineers, skilled trade workers, architects, building owners, building operators, fire and building officials, manufacturers, and representatives of general interests.

The CCBFC was advised on scope, policy and technical issues pertaining to the Codes by the Provincial/Territorial Policy Advisory Committee on Codes (PTPACC), which was a committee of senior representatives from provincial/territorial ministries responsible for building, fire, plumbing and energy regulation in their jurisdictions. The PTPACC was created by the provinces and territories, with provision of guidance to the CCBFC as one of its main functions. Through the PTPACC, the provinces and territories were engaged in every phase of the Codes development process.

Codes Canada staff within the Construction Research Centre at the NRC provided technical and administrative support to the CCBFC and its standing committees, and coordinated the provision of evidence-based research to inform Codes development. The NRC publishes the National Model Codes and periodic revisions to the Codes to address pressing issues.

The broader Codes-user community makes significant contributions to the Codes development process by submitting requests for changes or additions to the Codes and by commenting on the proposed changes during the public reviews that precede each new edition.

The CCBFC took into consideration the advice received from the provinces and territories as well as Codes users' comments at each stage of Codes development. The scope and content of the National Model Codes are determined on a consensus basis, which involves the review of technical, policy and practical concerns and discussion of the implications of these concerns.

More information on the Codes development process is available on the CBHCC's website.

National Energy Code of Canada for Buildings 2020

The NECB sets out technical provisions to address energy efficiency in the design and construction of new buildings and additions to existing buildings. In the context of the NECB, the term “energy efficiency” is understood to mean “energy use efficiency.”

Code provisions do not necessarily address all the characteristics of buildings that might be considered to have a bearing on the Code's objective. Through the extensive consensus process used to develop and maintain the National Model Codes (see the section entitled Development of the National Model Codes), the Codes-user community has decided which characteristics should be regulated through the NECB.

The provisions of the NECB can be considered as the minimum acceptable measures required to adequately achieve the Environment objective, as recommended by the CCBFC. Once they are adopted into law or regulation by an authority having jurisdiction, the provisions become minimum acceptable requirements representing the minimum level of performance required to achieve the objective that is acceptable to the adopting authority.

The NECB is a model code which, when adopted or adapted by a province or territory, becomes a regulation. It is not a guideline on the design or construction of energy-efficient buildings. The design of an energy-efficient building depends upon many factors beyond compliance with energy regulations. Such factors include the availability of knowledgeable practitioners who have received appropriate education, training and experience and who are familiar with the principles of good building practice and experience using reference manuals and technical guides.

The NECB does not list acceptable proprietary building products. It establishes the criteria that building materials, products and assemblies must meet. Some of these criteria are explicitly stated in the NECB while others are incorporated by reference to material or product standards published by standards development organizations. Only those portions of the standards related to the objective of this Code are mandatory parts of the NECB.

Relationship between the NBC and the NECB

The provisions in Section 9.36. of Division B of the NBC are tied to the Environment objective. These provisions, which apply to housing and small buildings, have a similar scope to that of the NECB, except that they do not address lighting and electrical power systems. The NECB is referenced in NBC Section 9.36. as an acceptable solution.

Code Requirements

The NECB establishes requirements that address one principal objective, Environment (OE), which comprises a second-level objective, Resources (OE1), and a sub-objective, Excessive Use of Energy (OE1.1). Every NECB requirement addresses sub-objective OE1.1.

In processing proposed changes or additions to any of the National Model Codes, many issues are considered, such as the following:

- Does the proposed requirement provide the minimum level of performance—and no more than the minimum—needed to achieve the Code's objectives?
- Will persons responsible for Code compliance be able to act on or implement the requirement using commonly accepted practices?
- Will enforcement agencies be able to enforce the requirement?
- Are the costs of implementing the requirement justifiable?
- Have the potential policy implications of the requirement been identified and addressed?
- Is there broad consensus on this requirement among Code users representing all facets of the design and construction industries as well as among provincial and territorial governments?

Guidelines for requesting changes to the NECB are available on the CBHCC's website.

Objective-Based Code Format

The NECB has been published in an objective-based code format since 2011.

As described in more detail in the section entitled Structure of the NECB, the Code comprises three Divisions:

- Division A, which defines the scope of the Code and contains the objective, the functional statements and the conditions necessary to achieve compliance;
- Division B, which contains acceptable solutions (commonly referred to as “technical requirements”) deemed to satisfy the objective and functional statements listed in Division A; and
- Division C, which contains administrative provisions.

Most of the requirements in Division B are linked to three types of information:

- sub-objective OE1.1, Excessive Use of Energy,
- functional statements (statements of the functions of the building that a particular requirement helps to achieve), and
- an intent statement (detailed statement of the specific intent of the requirement).

Objectives

The NECB's objectives are fully defined in Section 2.2. of Division A.

The objectives describe, in broad terms, the overall goals that the NECB's requirements are intended to achieve. They serve to define the boundaries of the subject areas the Code addresses. However, the Code does not address all the issues that might be considered to fall within those boundaries.

The objectives describe undesirable situations and their consequences, which the Code aims to prevent from occurring in buildings. The wording of the definitions of the objectives includes two key phrases: “limit the probability” and “unacceptable effect.” The phrase “limit the probability” is used to acknowledge that the NECB cannot entirely prevent the undesirable outcome from happening. The phrase “unacceptable effect” acknowledges that the NECB cannot eliminate all undesirable effects: the “acceptable effect” is the outcome remaining once compliance with the Code has been achieved.

The objectives are entirely qualitative and are not intended to be used on their own in the design and approval processes.

Functional Statements

The NECB's functional statements are listed in Section 3.2. of Division A.

The functional statements are more detailed than the objectives. They describe conditions in the building that help satisfy the objectives. The functional statements and the objectives are interconnected. There may be several functional statements related to any one objective.

Like objectives, functional statements are entirely qualitative and are not intended to be used on their own in the design and approval processes.

The objective / functional statement sets attributed to the requirements or portions of requirements in Division B are listed in a table at the end of each Part of Division B.

Intent Statements

Intent statements explain the basic thinking behind each Code provision contained in Division B. Intent statements, each of which is unique to the provision with which it is associated, explain how requirements help to achieve their attributed sub-objective and functional statements. Like the objectives, the intent statements are expressed in terms of risk avoidance and expected performance. They offer insight into the views of the responsible standing committee on what the Code provisions are intended to achieve.

The intent statements serve explanatory purposes only and do not form an integral part of the Code provisions. As such, they are similar in function to the explanatory Notes at the end of each Part. Due to the sheer volume of intent statements—hundreds for the NECB alone—they are made available as a separate electronic document entitled “Supplement to the NECB 2020: Intent Statements,” which is posted on the NRC's website.

All this additional information—objectives, functional statements and intent statements—is intended to facilitate the implementation of the Code in two ways:

- **Clarity of intent:** The objectives, functional statements and intent statements linked to a Code requirement clarify the reasoning behind that requirement and facilitate understanding of what must be done to satisfy that requirement. This added information may also help avoid disputes between practitioners and officials over these types of issues.
- **Flexibility:** The additional information allows for flexibility in Code compliance. A person seeking to propose a new method or material not described or covered in the Code will be able to use the added information to understand the expected level of performance that their alternative solution must achieve to satisfy the Code.

Structure of the NECB

The NECB is organized into three Divisions.

Division A: Compliance, Objectives and Functional Statements

Division A defines the scope of the NECB and presents the objective that the Code addresses and the functions the building must perform to help to satisfy that objective.

Division A cannot be used on its own as a basis for designing and constructing a building, or for evaluating a building's compliance with the Code.

Division B: Acceptable Solutions

The term “acceptable solutions” refers to the technical requirements contained in the Code. It reflects the principle that energy codes establish an acceptable level of risk or performance and underlines the fact that a code cannot describe all possible valid

design and construction options. Acceptable solutions represent the minimum level of performance that will satisfy the NECB's objective and that is acceptable to an authority that adopts the NECB into law or regulation.

Most of the requirements in Division B—the acceptable solutions—are linked to the sub-objective OE1.1 and to one or more functional statements found in Division A. These linkages play an important role in allowing objective-based codes to accommodate innovation.

It is expected that the majority of Code users will primarily follow the acceptable solutions presented in Division B and that they will consult Division A only when seeking clarification on the application of Division B's requirements to a particular situation, when considering an alternative solution, or when looking up the definition of selected terms in the context of the NECB.

Division C: Administrative Provisions

Division C contains administrative provisions relating to the application of the Code. Many provinces and territories establish their own administrative provisions upon adopting or adapting the NECB; having all the administrative provisions in one Division facilitates their customization to suit jurisdictional needs.

In addition, a separate document entitled Administrative Requirements for Use with the National Building Code of Canada 1985 is automatically adopted, in accordance with Article 2.2.1.1. of Division C, if the authority having jurisdiction does not provide other administrative requirements.

Relationship between Division A and Division B

Sentence 1.2.1.1.(1) of Division A is a very important sentence: it is a precise statement of the relationship between Divisions A and B and is central to the concept of objective-based codes.

- 1)** Compliance with this Code shall be achieved by
- a) complying with the applicable acceptable solutions in Division B (see Note A-1.2.1.1.(1)(a)), or
 - b) using alternative solutions that will achieve at least the minimum level of performance required by Division B in the areas defined by the objective and functional statements attributed to the applicable acceptable solutions (see Note A-1.2.1.1.(1)(b)).

Clause (a) makes it clear that the acceptable solutions in Division B are automatically deemed to satisfy the linked sub-objective and functional statements of Division A.

Clause (b) makes it clear that alternative solutions can be used in lieu of compliance with the acceptable solutions. However, to do something different from the acceptable solutions described in Division B, a proponent must show that their proposed alternative solution will perform at least as well as the acceptable solution(s) it is replacing. The sub-objective and functional statements attributed to the acceptable solution(s) identify the areas of performance where this equivalence must be demonstrated.

Parts in Division B and Professional Disciplines

Division B is organized into Parts that are largely related to professional disciplines. However, this does not mean that a person belonging to a certain profession who is executing the design or construction of a particular building component can necessarily work with only one Part of the Code in isolation, since provisions related to that building component may be found in more than one Part. For this reason, the Part-based structure of Division B is not well suited for use as the basis for allocating responsibilities to different professions or as the basis for contractual arrangements.

What's New in the 2020 Edition

Relocation of Part-Load Performance Characteristics

To improve ease of use, the part-load performance characteristics that were formerly tabulated in Article 8.4.4.21. have been moved to new Subsection 8.4.5.

New Part 10

New Part 10 has been introduced into Division B to establish tiered building energy performance compliance. Four energy performance tiers are specified, with each successive tier being increasingly stringent in terms of building energy consumption.

Additional Information

Numbering System

A consistent numbering system has been used throughout the National Model Codes. The first number indicates the Part of the Code; the second, the Section in the Part; the third, the Subsection; and the fourth, the Article in the Subsection. The detailed provisions are found at the Sentence level (indicated by numbers in brackets), and Sentences may be broken down into Clauses and Subclauses. This structure is illustrated as follows:

3	Part
3.5.	Section
3.5.2.	Subsection
3.5.2.1.	Article
3.5.2.1.(2)	Sentence
3.5.2.1.(2)(a)	Clause
3.5.2.1.(2)(a)(i)	Subclause

Meaning of the Words “And” and “Or” between the Clauses and Subclauses of a Sentence

Multiple Clauses and Subclauses are connected by the word “and” or “or” at the end of the second last Clause or Subclause in the series. Although this connecting word appears only once, it is meant to apply to all the preceding Clauses or Subclauses within that series.

For example, in a series of five Clauses—(a) to (e)—in a Sentence, the appearance of the word “and” at the end of Clause (d) means that all Clauses in the Sentence are connected to each other with the word “and.” Similarly, in a series of five Clauses—(a) to (e)—in a Sentence, the appearance of the word “or” at the end of Clause (d) means that all Clauses in the Sentence are connected to each other with the word “or.”

In all cases, it is important to note that a Clause (and its Subclauses, if any) must always be read in conjunction with its introductory text appearing at the beginning of the Sentence. Moreover, the connecting words “and” and “or” must be read in the context of the Sentence. In particular, the use of the word “and” as a connecting word does not necessarily mean that all Clauses (or Subclauses) are applicable for compliance with the Sentence.

Change Indication

As a courtesy to Code users, efforts have been made to identify technical changes relative to the 2017 edition. Where a technical addition or revision has been made, a vertical line has been added in the margin next to the affected provision to indicate the approximate

location of the new or revised content. No change indication is provided for editorial revisions or for renumbered or deleted content.

Units

All values in the NECB are given in metric units. Some of the metric values in the Code have been converted and rounded from imperial values. A conversion table of imperial equivalents for the most common units used in the design and construction of energy-efficient buildings is located at the end of the Code.

Complementary Publications

The following publications are referenced in the NECB 2020 or facilitate the application of its requirements:

- National Building Code of Canada 2020
- National Fire Code of Canada 2020
- National Plumbing Code of Canada 2020
- Supplement to the NECB 2020: Intent Statements
- User's Guide – National Energy Code of Canada for Buildings 2020

These and other Code documents published by the NRC are made available in free electronic format on the NRC's website.

Commercial Reproduction

Copyright for the NECB is owned by the NRC. All rights are reserved. Commercial reproduction by any means of the NRC's copyright material is prohibited without the written consent of the NRC. To request permission to reproduce the NECB, please contact:

- Production and Marketing Manager
- Codes Canada
- National Research Council of Canada
- 1200 Montreal Road
- Ottawa, Ontario K1A 0R6
- E-mail: Codes@nrc-cnrc.gc.ca

Contact Information

The CBHCC welcomes comments and suggestions for improvements to the NECB. Persons interested in requesting a change to an NECB provision should refer to the guidelines available on the CBHCC's website.

To submit comments or suggestions, please contact:

- The Secretary
- Canadian Board for Harmonized Construction Codes
- 1200 Montreal Road
- Ottawa, Ontario K1A 0R6
- E-mail: CBHCCSecretary-SecretaireCCHCC@nrc-cnrc.gc.ca

Relationship of the NECB to Standards Development and Conformity Assessment

The development of many provisions in the NECB and the assessment of conformity to those provisions are supported by several of the member organizations of Canada's National Standards System (NSS).

The NSS is a network of accredited organizations concerned with standards development, certification, testing and inspection that is established under the auspices of the Standards Council of Canada Act. Activities of the NSS are coordinated by the Standards Council of Canada (SCC), which accredits standards development organizations, certification bodies, testing and calibration laboratories, and inspection bodies, among others.

The SCC is a non-profit federal Crown corporation responsible for the coordination of voluntary standardization in Canada. It also coordinates Canadian participation in voluntary international standardization activities.

Canadian Standards

Many of the standards referenced in the NECB are published by standards development organizations accredited in Canada. As part of the accreditation requirements, these organizations adhere to the principle of consensus, which generally means substantial majority agreement of a committee comprising a balance of producer, user and general interest members, and the consideration of all negative comments. The standards development organizations also have formal procedures for the balloting and second-level review of standards prepared under their oversight.

The following organizations are accredited as standards development organizations in Canada:

- Air-Conditioning, Heating and Refrigeration Institute (AHRI)
- ASTM International
- Bureau de normalisation du Québec (BNQ)
- Canadian General Standards Board (CGSB)
- CSA Group
- International Association of Plumbing and Mechanical Officials (IAPMO)
- ULC Standards
- Underwriters' Laboratories Inc. (UL)

Table 1.3.1.2. of Division B lists the standards referenced in the NECB. Standards proposed to be referenced in the NECB are reviewed to ensure that their content is compatible with the Code. Thereafter, referenced standards are reviewed as needed during each Code cycle. Standards development organizations are asked to provide information on any changes in the status of their standards referenced in the NECB—withdrawals, amendments, new editions, etc. This information is passed on to the CBHCC, its code development committees, and interested stakeholders, all of whom are given the opportunity to identify any problems associated with the changes. These bodies do not necessarily review in detail the revised standards; rather, the approach relies on the consensus process involved in the maintenance of the standards and on the extensive knowledge and experience of committee members, provincial or territorial staff, NRC staff, and consulted stakeholders to identify changes in the standards that might create problems in the Code.

Non-Canadian Standards

A number of subject areas for which the standards development organizations accredited in Canada have not developed standards are covered in the NECB. In these cases, the Code often references standards developed by organizations in other countries, such as the American Society of Heating, Refrigerating and Air-Conditioning Engineers (ASHRAE) and the National Fire Protection Association (NFPA). These standards are developed using processes that may differ from those used by the standards development organizations accredited in Canada; nevertheless, the standards have been reviewed by the relevant standing committees and found to be acceptable.

Conformity Assessment

The NECB establishes minimum measures, which are set out within its own text or within referenced standards. However, the NECB does not set out who is responsible for assessing conformity to the measures or how those with this responsibility might carry it out. This responsibility is usually established by the governing legislation of the adopting provinces and territories. Provincial or territorial authorities should be consulted to determine who is responsible for conformity assessment within their jurisdiction.

Those persons responsible for ensuring that materials, appliances, systems and equipment meet the requirements of this Code have several means available to assist them, ranging from on-site inspection to the use of certification services provided by accredited third-party organizations. Test reports or mill certificates provided by manufacturers or suppliers can also assist in the acceptance of products. Engineering reports may be required for more complex products.

Testing

The SCC accredits testing and calibration laboratories that are capable of reliably testing products to specified standards. The test results produced by these organizations can be used in the certification, evaluation and qualification of products for compliance with Code provisions. The SCC's website (www.scc.ca) lists accredited testing and calibration laboratories, along with their scope of accreditation.

Certification

Certification is the confirmation by an independent organization that a product, process, service or system meets a requirement. Certification may entail physical examination, testing as specified in appropriate standards, an initial plant inspection, and/or follow-up unannounced plant inspections. This procedure leads to the issuing of a formal assurance or declaration, by means of a certification mark or certificate, that the product, process, service or system is in full conformity with specified provisions.

In some cases, a product for which no standard exists can be certified using procedures and criteria developed by an accredited certification body and specifically designed to measure the performance of that product.

Certification bodies publish lists of certified products and companies. The SCC's website (www.scc.ca) lists accredited certification bodies, along with their scope of accreditation. Several organizations, including the Canadian Construction Materials Centre (CCMC) at the NRC, offer product certification services.

Evaluation

An evaluation is a written opinion by an independent professional organization that a product will perform its intended function. An evaluation is often done to determine the ability of an innovative product, for which no standards exist, to satisfy the intent of a Code requirement. Follow-up plant inspections are not normally part of the evaluation process.

Qualification

Qualification evaluates the ability of a product to perform its intended function by verifying that it meets the requirements of a standard. Qualification normally includes some follow-up plant inspection. Some organizations publish lists of qualified products that meet the specified requirements. Some organizations qualify product manufacturing and/or testing facilities for compliance with the Code and relevant standards.

Canadian Commission on Building and Fire Codes and Standing Committees

Canadian Commission on Building and Fire Codes

D. Crawford (<i>Chair</i>)	C. Gray	T. Ross	Codes Canada staff who provided assistance to the Commission
R. Arsenault	H. Griffin	R. Rymell	
K. Block	K. Griffiths	B. Sim	
A. Borooh	T. Harper	S. Stinson	M. Dumoulin
R. Brooks	L. Holmen	D. Sullivan	G. Gosselin
J. Chauvin	C. Joseph ⁽¹⁾	A. Tabet	A. Gribbon
M. Cianchetti	K. Lee	P. Thorkelsson	P. Jago
T. Cochren	B. Lorne	M. Tovey	A. Laroche
V. de Passillé	D. MacKinnon	C. Tye	F. Lohmann
R. Dulmage	M. McSweeney	E. Whalen	P. Rizcallah
C. Fillingham	G. Morinville	G. Yoshida	R. Tremblay
S. Garcia	S. Ottens		
K. Gloge	R. Richard		

Standing Committee on Energy Efficiency in Buildings⁽²⁾

A. Pride (<i>Chair</i>)	A. Pape-Salmon
D. Bailey	J. Pockar
D. Bartel	M. Roy
N. Brisson	T. Ryce
A. Cameron	P. Sectakof
R. Cardinal	M. Slivar
J. Comtois	A. Syed
L. Dalglish	
B. Darrell	Codes Canada staff who provided assistance to the Committee
F. Genest	
H. Hayne	E. Girgis
C. Kahramanoglu	M. Mihailovic
M. Kelly	P. Tardif
T. Lau	R. Ullah
N. Lessard	M. Zeghal
Rd. Marshall	
Rt. Marshall	

Standing Committee on Energy Efficiency⁽³⁾

A. Pride (<i>Chair</i>)	A. Oding
P. Andres	C. O'keefe
D. Bailey	M. Peer
R. Bortolussi	J. Pockar
J. Comtois	D. Rambaruth
S. Crowell	M. Roy
L. Dalglish	L. Wynder
B. Deeks	
S. Dueck	Codes Canada staff who provided assistance to the Committee
L. Hasan	
T. Imhoff	Y. Carrier
S. Kemp	S. Gibb
D. Krauel	E. Girgis
C. Kuruluk	R. Hassan
T. Lau	H. Martin
N. Lessard	M. Nazim
W. Leung	R. Ullah
J. Mantyla	M. Zeghal
Rd. Marshall	
Z. May	

Technical Translation Verification Committee

G. Harvey (<i>Chair</i>)	Codes Canada staff
F. Genest	who provided assistance
B. Lagueux	to the Committee
N. Lessard	I. Bastien
I. Wagner	M. Gingras
	K. Le Van
	G. Mougeot-Lemay
	S. Veilleux

-
- (1) Resigned on September 23, 2016, due to employment opportunity with Codes Canada.
 - (2) Term ended on June 4, 2018.
 - (3) Term started on May 10, 2018.

Revisions and Errata

Issued by the Canadian Board for Harmonized Construction Codes

The Change Summary table that follows describes revisions, errata and editorial modifications that apply to the National Energy Code of Canada for Buildings 2020:

- Revisions are changes that have been approved by the Canadian Board for Harmonized Construction Codes for publication between Code editions.
- Errata are corrections to existing text.
- Editorial updates are provided for information purposes only.
- Editorial changes are modifications that improve clarity.

Code pages containing revisions and/or errata are identified with the words “Amended Page” in the footer; pages with editorial modifications are not flagged.

Code users should contact their local authority having jurisdiction to find out if these revisions and errata apply in their province or territory.

Change Summary (Date: 2025-02) — National Energy Code of Canada for Buildings 2020

Division	Code Reference	Change	Description of Change
Preface	n/a	editorial update	Preface was updated to reflect change in governance of national code development system
B	1.3.1.1.(1)	revision	Date stated in Sentence was revised to read “15 July 2022”
	Table 1.3.1.2.	revision	Document references were updated as applicable to reflect more recent editions published as of 15 July 2022
	1.3.2.1.	editorial update	List of abbreviations was updated to include “CBHCC”
	Table C-1	erratum	“Degree-Days Below 15°C” entries for several locations in the Northwest Territories and Nunavut were corrected
C	2.2.2.6.	editorial change	Article was revised as follows: Article title was revised to read “Documentation on Service Water Systems” Sentence (1) was revised to read “... on the <i>service water</i> system ...”
	A-2.3.1.	editorial update	Last paragraph of Note was updated to read “... on the CBHCC’s website.”
Index	Letter D	editorial change	“Documentation”: “service water heating” was revised to read “service water systems”
	Letter I	erratum	“Integrated coefficient of performance (ICOP)”: entry was deleted

Division A

Compliance, Objectives and Functional Statements



Division A

Part 1 Compliance

1.1.	General	
1.1.1.	Application of this Code	1-1
1.2.	Compliance	
1.2.1.	Compliance with this Code	1-1
1.2.2.	Materials, Appliances, Systems and Equipment	1-2
1.3.	Divisions A, B and C of this Code	
1.3.1.	General	1-2
1.3.2.	Application of Division A	1-2
1.3.3.	Application of Division B	1-2
1.3.4.	Application of Division C	1-3
1.4.	Terms and Abbreviations	
1.4.1.	Definitions of Words and Phrases ..	1-3
1.4.2.	Symbols and Other Abbreviations ..	1-7
1.5.	Referenced Documents and Organizations	
1.5.1.	Referenced Documents	1-9
1.5.2.	Organizations	1-9
	Notes to Part 1	1-11

Division A

Part 1 Compliance

Section 1.1. General

1.1.1. Application of this Code

1.1.1.1. Application of this Code

1) Except as provided in Sentence (3), this Code applies to the design and construction of all new *buildings* described in Sentence 1.3.3.2.(1) of Division A of the NBC and to *additions*. (See Note A-1.1.1.1.(1).)

2) This Code applies to subsequent alterations to and within *buildings* originally constructed in accordance with this Code. (See Note A-1.1.1.1.(2).)

3) This Code does not apply to *farm buildings*.

1.1.1.2. Building Parameters Covered by this Code

- 1) This Code contains requirements for
- a) the design and construction of the *building envelope*,
 - b) the design and construction or specification of systems and equipment for
 - i) heating, ventilating or air-conditioning,
 - ii) *service water*, and
 - iii) lighting, and
 - c) the provision of electrical power systems and motors, excluding process loads.

1.1.1.3. Relationship to Other Building Regulations

1) This Code shall be used in conjunction with applicable federal, provincial or territorial regulations or municipal bylaws or, in the absence of such regulations or bylaws, in conjunction with the NBC.

2) Where the requirements of this Code are in conflict with the requirements of the regulations or bylaws referred to in Sentence (1) or, where applicable, with the NBC, the requirements providing the greatest performance level shall govern.

Section 1.2. Compliance

1.2.1. Compliance with this Code

1.2.1.1. Compliance with this Code

- 1) Compliance with this Code shall be achieved by
- a) complying with the applicable acceptable solutions in Division B (see Note A-1.2.1.1.(1)(a)), or
 - b) using alternative solutions that will achieve at least the minimum level of performance required by Division B in the areas defined by the objective and functional statements attributed to the applicable acceptable solutions (see Note A-1.2.1.1.(1)(b)).

1.2.2.1.

2) For the purposes of compliance with this Code as required in Clause (1)(b), the objective and functional statements attributed to the acceptable solutions in Division B shall be the objective and functional statements referred to in Subsection 1.1.2. of Division B.

1.2.2. Materials, Appliances, Systems and Equipment**1.2.2.1. Characteristics of Materials, Appliances, Systems and Equipment**

1) All materials, appliances, systems and equipment installed to meet the requirements of this Code shall possess the necessary characteristics to perform their intended functions when installed in a *building*.

1.2.2.2. Storage on the Building Site

1) All *building* materials, appliances and equipment on the *building* site shall be stored in such a way as to prevent the deterioration or impairment of their essential properties.

1.2.2.3. Used Materials, Appliances and Equipment

1) Unless otherwise specified, used materials, appliances and equipment are permitted to be reused when they meet the requirements of this Code for new materials and are satisfactory for the intended use.

Section 1.3. Divisions A, B and C of this Code**1.3.1. General****1.3.1.1. Scope of Division A**

1) Division A contains the compliance and application provisions, objectives and functional statements of this Code.

1.3.1.2. Scope of Division B

1) Division B contains the acceptable solutions of this Code.

1.3.1.3. Scope of Division C

1) Division C contains the administrative provisions of this Code.

1.3.1.4. Internal Cross-references

1) Where the Division of a referenced provision is not specified in this Code, it shall mean that the referenced provision is in the same Division as the referencing provision.

1.3.2. Application of Division A**1.3.2.1. Application of Parts 1, 2 and 3**

1) Parts 1, 2 and 3 of Division A apply to all *buildings* covered in this Code. (See Article 1.1.1.1.)

1.3.3. Application of Division B**1.3.3.1. Application of Parts 1, 3 to 8 and 10**

1) Parts 1, 3 to 8 and 10 of Division B apply to all *buildings* covered in this Code. (See Article 1.1.1.1.)

1.3.4. Application of Division C

1.3.4.1. Application of Parts 1 and 2

1) Parts 1 and 2 of Division C apply to all *buildings* covered in this Code. (See Article 1.1.1.1.)

Section 1.4. Terms and Abbreviations

1.4.1. Definitions of Words and Phrases

1.4.1.1. Non-defined Terms

1) Words and phrases used in this Code that are not included in the list of definitions in Article 1.4.1.2. shall have the meanings that are commonly assigned to them in the context in which they are used, taking into account the specialized use of terms by the various trades and professions to which the terminology applies.

2) Where objectives and functional statements are referred to in this Code, they shall be the objectives and functional statements described in Parts 2 and 3.

3) Where acceptable solutions are referred to in this Code, they shall be the provisions stated in Parts 3 to 8 and 10 of Division B.

4) Where alternative solutions are referred to in this Code, they shall be the alternative solutions mentioned in Clause 1.2.1.1.(1)(b).

1.4.1.2. Defined Terms

1) The words and terms in italics in this Code shall have the following meanings:

Addition means any *conditioned space* that is added to an existing *building* and that increases the *building's floor surface area* by more than 10 m².

Air barrier assembly means the combination of air barrier materials and air barrier accessories within the environmental separator that are designed to act as a continuous barrier to the movement of air through the environmental separator.

Airflow control area means a portion of a *building* to which the flow of air from the heating, ventilating or air-conditioning air distribution system can be reduced or stopped without reducing or stopping the flow of air to other portions of the *building*.

Annual energy consumption means the annual sum of the lighting, *service water* heating and space-conditioning energy consumption of the proposed *building* design, as calculated in accordance with the requirements of Part 8 of Division B.

*Assembly occupancy** means the *occupancy* or the use of a *building*, or part thereof, by a gathering of persons for civic, political, travel, religious, social, educational, recreational or like purposes, or for the consumption of food or drink.

*Authority having jurisdiction** means the governmental body responsible for the enforcement of any part of this Code or the official or agency designated by that body to exercise such a function.

Boiler means an *appliance*[†] intended to supply hot water or steam for space or *service water* heating purposes, except *storage-type service water heaters*.

*Building** means any structure used or intended for supporting or sheltering any use or *occupancy*.

Building energy target means the *annual energy consumption* of a hypothetical replica of the proposed *building*, using the same energy sources for the same functions and having the same environmental requirements, *occupancy*, climatic data and operation schedules as the proposed *building*, but made to comply with all applicable prescriptive requirements of this Code.

* The definition of this term is reproduced from the National Building Code of Canada 2020.

† The definition of this term can be found in the National Building Code of Canada 2020.

Building envelope means the collection of components that separate *conditioned space* from unconditioned space, the exterior air or the ground, or that separate *conditioned spaces* intended to be conditioned to temperatures differing by more than 10°C at design conditions. (See Note A-1.4.1.2.(1).)

*Building height** (in *storeys*) means the number of *storeys* contained between the roof and the floor of the *first storey*.[†]

Ceiling height (CH) means the average height of the ceiling where there is a ceiling and the average height of the base of the installed luminaires where there is no ceiling.

Coefficient of performance (COP) means, for a heat pump in the heating mode, the ratio of the rate of net heat output to the total energy input expressed in consistent units and under designated rating conditions, as described in the standards referenced in this Code; for refrigerating equipment or a heat pump in the cooling mode, COP means the ratio of the rate of heat removal to the rate of energy input in consistent units and under designated rating conditions, as described in the standards referenced in this Code.

Combustion efficiency (E_c) means a measure of the efficiency of fuel-burning equipment in converting fuel to heat, as obtained through the procedures described in the standards referenced in this Code.

*Conditioned space** means any space within a *building*, the temperature of which is controlled to limit variation in response to the exterior ambient temperature by the provision, either directly or indirectly, of heating or cooling over substantial portions of the year.

*Dwelling unit** means a *suite* operated as a housekeeping unit, used or intended to be used by one or more persons and usually containing cooking, eating, living, sleeping and sanitary facilities.

Enclosed space means a volume substantially surrounded by solid surfaces such as full-height walls or *partitions*, floors, ceilings, and openable devices such as doors and operable windows.

Energy-efficiency ratio (EER) means, for refrigerating equipment or a heat pump in the cooling mode, the ratio of net cooling capacity in Btu/h to the total rate of electric input in watts, under designated operating conditions, as described in the standards referenced in this Code.

Energy factor (EF) means a measure of overall energy efficiency in terms of energy output compared to energy consumption over a 24-h usage cycle and is obtained as described in the standards referenced in this Code.

Exhaust duct means a duct through which air is conveyed from an interior space to the outdoors or to unconditioned space.

*Exit** means that part of a *means of egress*,[†] including doorways, that leads from the *floor area*[†] it serves to a separate *building*, an open public thoroughfare, or an exterior open space protected from fire exposure from the *building* and having access to an open public thoroughfare.

Exterior entrance means a doorway used for entering, or for entering and exiting, a *building*, that leads from an exterior space to a space provided with *interior lighting*.

Exterior exit means a doorway used only for exiting from an area provided with *interior lighting* to an exterior space.

Exterior lighting means lighting other than *interior lighting*.

Facade lighting means lighting installed to highlight features of the principal front of a *building* or a face of a *building* that overlooks a street or open space and includes lighting installed on the facade and on constructed or natural surfaces in close proximity to the facade. *Facade lighting* does not include signage or other lighting installed on the facade that is intended to light exterior spaces or surfaces other than the facade.

*Farm building** means a *building* or part thereof that contains an *agricultural occupancy*.[†]

Fenestration means all *building envelope* assemblies, including their *frames*, that transfer visible light, such as windows, clerestories, *skylights*, translucent wall panels, glass

block assemblies, transoms, sidelights, sliding, overhead or swinging glass doors, and glazed inserts in doors, etc.

*Firewall** means a type of *fire separation*[†] of *noncombustible construction*[†] that subdivides a *building* or separates adjoining *buildings* to resist the spread of fire and that has a *fire-resistance rating*[†] as prescribed in the NBC or NFC and has structural stability to remain intact under fire conditions for the required fire-rated time.

Floor surface area means the area of a floor surface, including heated garages, measured from the interior surface of the perimeter walls at or near floor level, including the area occupied by columns, interior walls and openings in the floor.

*Foundation** means a system or arrangement of *foundation units*[†] through which the loads from a *building* are transferred to supporting *soil*[†] or *rock*.[†]

Frame in a door, window or other glazed area means the associated head, jambs, sill and, where applicable, mullions which, when assembled, house the door, *sash* or fixed glazing.

*Furnace** means a *space-heating appliance*[†] using warm air as the heating medium and usually having provision for the attachment of ducts.

General lighting means lighting that provides primary illumination throughout an interior area. *General lighting* shall not include decorative lighting or lighting that provides a dissimilar level of illumination within that area to serve a specialized application or feature.

*Grade** means the lowest of the average levels of finished ground adjoining each exterior wall of a *building*, except that localized depressions need not be considered in the determination of average levels of finished ground. (See *First storey*.[†])

Gross lighted area means the total area served by *interior lighting*, including the areas occupied by *partitions* but excluding areas occupied by exterior enclosing assemblies and by elevator and service shafts. (See Note A-1.4.1.2.(1).)

Heat trap means an energy-conserving arrangement of the water piping entering or leaving a *service water* heater constructed to counteract the convective forces of the hot water (thermosyphoning) during standby periods.

Installed interior lighting power means the power, in watts, used by all the lighting systems that are part of the complete *interior lighting* design.

Integrated energy-efficiency ratio (IEER) means a single-number figure of merit expressing cooling part-load energy efficiency for air-conditioning and heat pump equipment that is based on weighted operation at various load capacities of the equipment, as described in the standards referenced in this Code.

Integrated part-load value (IPLV) means a single-number figure of merit based on part-load *energy-efficiency ratio* or *coefficient of performance* expressing part-load efficiency for air-conditioning and heat pump equipment that is based on weighted operation at various load capacities of the equipment, as described in the standards referenced in this Code.

Interior lighting means

- (a) lighting installed in spaces that are within the *building envelope*, and
- (b) lighting installed in unconditioned or *conditioned spaces* that are sheltered from the outdoor environment and intended to light only those spaces, except for lighting at *exterior entrances* and *exterior exits*.

(See Note A-1.4.1.2.(1).)

Interior lighting power allowance means the maximum lighting power allowed to be provided to illuminate the interior of a *building*.

Landscape lighting means lighting installed to highlight landscape elements, such as trees, shrubs, rocks and pools. *Landscape lighting* does not include lighting of exterior spaces or walkways.

*Occupancy** means the use or intended use of a *building* or part thereof for the shelter or support of persons, animals or property.

Opaque building assembly means a *building assembly* that is part of the *building envelope*, other than doors, and does not admit light.

Overall thermal transmittance (U-value) means the rate, in $W/(m^2 \times K)$, at which heat is transferred through a *building assembly* that is subject to a temperature difference. It represents the amount of heat transferred through a unit area in a unit of time induced under steady-state conditions by a unit temperature difference between the environments on its two faces. The U-value reflects the capacity of all elements to transfer heat through the thickness of the assembly, as well as, for instance, through air films on both faces of above-ground components. Where heat is not transferred homogeneously across the area being considered, the *overall thermal transmittance* shall be determined. (See Note A-1.4.1.2.(1).)

*Partition** means an interior wall 1 *storey* or part-*storey* in height that is not *loadbearing*.[†]

*Plenum** means a chamber forming part of an air duct system.

Primary system means the combination of equipment working as a system that converts electricity or fuel to heating or cooling and may distribute it to one or more *secondary systems* (e.g. *boilers* and *chillers*), where such equipment is not already defined as part of the *secondary system*.

*Repair garage** means a *building* or part thereof where facilities are provided for the repair or servicing of motor vehicles.

*Return duct** means a duct for conveying air from a space being heated, ventilated or air-conditioned back to the heating, ventilating or air-conditioning *appliance*.[†]

Sash means an assembly of secondary framing members that fits within the primary *frame* of a window and whose main purpose is to hold and support the glass in operable windows; however, a *sash* is often included in fixed windows to maintain a uniform appearance with operable windows.

Seasonal energy-efficiency ratio (SEER) means the total cooling, in Btu, provided by a central air conditioner or heat pump during its normal annual usage period for cooling, divided by its total electric power usage, in watt-hours, during that same period.

Secondary system means a system that provides air for the purposes of ventilating, heating and cooling a *thermal block* (e.g. fan system). *Secondary systems* may include dedicated equipment that converts electricity or fuel to heating or cooling. *Secondary systems* can be single-zone—serving only a single *thermal block*—or multiple-zone—serving one or more *thermal blocks*.

Service water means water for plumbing systems, but not water for systems used exclusively for space-heating or -cooling, or for processes.

Sidelighting means the illumination of *building* interiors with daylight admitted through *fenestration* located on an exterior wall, such as windows.

Skylight means a form of *fenestration* that is inclined less than 60° from the horizontal.

Standby losses (SL) are the heat losses incurred by a *storage-type service water heater* under a stable condition when no water is withdrawn from the tank and the water temperature is held constant by the thermostats.

*Storage garage** means a *building* or part thereof intended for the storage or parking of motor vehicles and containing no provision for the repair or servicing of such vehicles. (See Note A-1.4.1.2.(1).)

*Storage-type service water heater** means a *service water heater*[†] with an integral hot water storage tank.

*Storey** means that portion of a *building* that is situated between the top of any floor and the top of the floor next above it, and if there is no floor above it, that portion between the top of such floor and the ceiling above it.

*Suite** means a single room or series of rooms of complementary use, operated under a single tenancy, and includes *dwelling units*, individual guest rooms in motels, hotels, boarding houses, rooming houses and dormitories as well as individual stores and individual or complementary rooms for *business and personal services occupancies*.[†] (See Note A-1.4.1.2.(1).)

Supply air handler means that part of a heating, ventilating and air-conditioning system that conditions return air and/or outdoor air and delivers it to the *supply ducts*.

*Supply duct** means a duct for conveying air from a heating, ventilating or air-conditioning *appliance*[†] to a space to be heated, ventilated or air-conditioned.

Temperature-control zone means a space that is controlled by an individual temperature-control device.

*Theatre** means a place of public assembly intended for the production and viewing of the performing arts or the screening and viewing of motion pictures, and consisting of an auditorium with permanently fixed seats intended solely for a viewing audience.

Thermal block means a space or group of spaces that is considered as one homogeneous space for modeling purposes. A *thermal block* shall be:

- (a) one *temperature-control zone*,
- (b) a group of *temperature-control zones*
 - (i) that are served by the same *secondary system* or by systems that can be considered to be identical,
 - (ii) that are operated and controlled in the same way, and
 - (iii) whose space use and envelope characteristics are sufficiently similar that the heating and cooling energy consumption obtained by modeling the group of zones as a *thermal block* is not significantly different from what would be obtained by summing the results for the individual zones modeled separately, or
- (c) a zone consisting entirely of indirectly *conditioned spaces*.

Thermal efficiency (E_t) means a measure of the efficiency of fuel-burning equipment in converting fuel to heat, as obtained through the procedures described in the standards referenced in this Code.

Toplighting means the illumination of *building* interiors with daylight admitted through *fenestration* located on the roof, such as *skylights* and roof monitors.

*Unit heater** means a suspended *space heater*[†] with an integral air-circulating fan.

1.4.2. Symbols and Other Abbreviations

1.4.2.1. Symbols and Other Abbreviations

1) The symbols and other abbreviations in this Code shall have the meanings assigned to them in this Article and Article 1.3.2.1. of Division B.

- A ampere(s)
- a annum (year)
- Btu British thermal unit(s)
- cfm cubic feet per minute
- CH *ceiling height*
- COP *coefficient of performance*
- ° degree(s) (of an angle)
- °C degree(s) Celsius
- °F degree(s) Fahrenheit
- db dry bulb (temperature)
- E_c *combustion efficiency*
- E_t *thermal efficiency*
- EER *energy-efficiency ratio*
- EF *energy factor*
- ft. foot (feet)
- gpm gallon(s) per minute
- > greater than
- ≥ greater than or equal to

h	hour(s)
HVAC	heating, ventilating and air-conditioning
IEER	<i>integrated energy-efficiency ratio</i>
IPLV	<i>integrated part-load value</i>
K	Kelvin
kg	kilogram(s)
kJ	kilojoule(s)
kVA	kilovolt ampere(s)
kW	kilowatt(s)
<	less than
≤	less than or equal to
L	litre(s)
lb.	pound(s)
LPD	lighting power density
lx	lux
m	metre(s)
max.	maximum
MBH	mega Btu/h
min.	minimum
min	minute(s)
mm	millimetre(s)
No.	number
o.c.	on centre
Pa	pascal(s)
%	per cent
R	thermal resistance value (imperial unit)
RSI	thermal resistance value (metric unit)
s	second(s)
SCOP	<i>seasonal coefficient of performance</i>
SEER	<i>seasonal energy-efficiency ratio</i>
SL	<i>standby losses</i>
Δt	temperature difference
US gal.	US gallon(s)
U-value	<i>overall thermal transmittance</i>
V	volt(s)
V _t	storage volume
W	watt(s)
wb	wet bulb (temperature)

Section 1.5. Referenced Documents and Organizations

1.5.1. Referenced Documents

1.5.1.1. Application of Referenced Documents

1) Except as provided in Sentence (2), the provisions of documents referenced in this Code, and of any documents referenced within those documents, apply only to the extent that they relate to

- a) *buildings*,
- b) *building* systems, and
- c) the objective and functional statements attributed to the applicable acceptable solutions in Division B where the documents are referenced.

(See Note A-1.5.1.1.(1).)

2) Where a provision of this Code references another National Model Code, the applicable objectives and functional statements shall include those found in that referenced National Model Code.

1.5.1.2. Conflicting Requirements

1) In the case of conflict between the provisions of this Code and those of a referenced document, the provisions of this Code shall govern.

1.5.1.3. Applicable Editions

1) Where documents are referenced in this Code, they shall be the editions designated in Subsection 1.3.1. of Division B.

1.5.2. Organizations

1.5.2.1. Abbreviations of Proper Names

1) The abbreviations of proper names in this Code shall have the meanings assigned to them in Article 1.3.2.1. of Division B.

Notes to Part 1 Compliance

A-1.1.1.1.(1) Application of this Code. This Code applies to buildings and their systems, components and assemblies at the time of their construction.

For the purpose of understanding the scope of this Code, an addition can be thought of as a new building that happens to be built contiguous to an existing building or as a new portion of an existing building.

A-1.1.1.1.(2) Application of this Code. This Code is intended to apply to alterations to and within buildings constructed in compliance with the NECB to ensure that future alterations and improvements to building assemblies, systems, equipment and components regulated by this Code, such as tenant improvements and renovations, continue to meet the requirements of this Code.

Designers should pay particular attention to situations where the Part 8 Performance Compliance Path is used. The assumptions used in the original energy model may need to be reviewed, and a new energy model may need to be prepared.

A-1.2.1.1.(1)(a) Code Compliance via Acceptable Solutions. If a building design (e.g. material, component, assembly or system) can be shown to meet all provisions of the applicable acceptable solutions in Division B (e.g. it complies with the applicable provisions of a referenced standard), it is deemed to have satisfied the objective and functional statements linked to those provisions and thus to have complied with that part of the Code. In fact, if it can be determined that a design meets all the applicable acceptable solutions in Division B, there is no need to consult the objectives and functional statements in Division A to determine its compliance.

A-1.2.1.1.(1)(b) Code Compliance via Alternative Solutions. Where a design differs from the acceptable solutions in Division B, then it should be treated as an “alternative solution.” A proponent of an alternative solution must demonstrate that the alternative solution addresses the same issues as the applicable acceptable solutions in Division B and their attributed objective and functional statements. However, because the objective and functional statements are entirely qualitative, demonstrating compliance with them in isolation is not possible. Therefore, Clause 1.2.1.1.(1)(b) identifies the principle that Division B establishes the quantitative performance targets that alternative solutions must meet. In many cases, these targets are not defined very precisely by the acceptable solutions—certainly far less precisely than would be the case with a true performance code, which would have quantitative performance targets and prescribed methods of performance measurement for all aspects of building performance. Nevertheless, Clause 1.2.1.1.(1)(b) makes it clear that an effort must be made to demonstrate that an alternative solution will perform as well as a design that would satisfy the applicable acceptable solutions in Division B—not “well enough” but “as well as.”

In this sense, it is Division B that defines the boundaries between acceptable situations and the “unacceptable” situations referred to in the statements of the Code’s objectives, i.e. the consequence remaining once the applicable acceptable solutions in Division B have been implemented represents the residual consequence deemed to be acceptable by the broad base of Canadians who have taken part in the consensus process used to develop the Code.

These Notes are included for explanatory purposes only and do not form part of the requirements. The number that introduces each Note corresponds to the applicable requirement in this Part.

Level of Performance

Where Division B offers a choice between several possible designs, it is likely that these designs may not all provide exactly the same level of performance. Among a number of possible designs satisfying acceptable solutions in Division B, the design providing the lowest level of performance should generally be considered to establish the minimum acceptable level of performance to be used in evaluating alternative solutions for compliance with the Code.

Sometimes a single design will be used as an alternative solution to several sets of acceptable solutions in Division B. In this case, the level of performance required of the alternative solution should be at least equivalent to the overall level of performance established by all the applicable sets of acceptable solutions taken as a whole.

Each provision in Division B has been analyzed to determine what it is intended to achieve. The resultant intent statements clarify what undesirable results each provision seeks to preclude. These statements are not a legal component of the Code, but are advisory in nature, and can help Code users establish performance targets for alternative solutions. They are published as a separate electronic document entitled "Supplement to the NECB 2020: Intent Statements," which is available on the NRC's website.

Areas of Performance

A subset of the acceptable solutions in Division B may establish criteria for particular types of designs (e.g. certain types of materials, components, assemblies, or systems). The acceptable solutions in Division B establish acceptable levels of performance for compliance with the Code only in those areas defined by the objective and functional statements attributed to the acceptable solutions.

Applicable Acceptable Solutions

In demonstrating that an alternative solution will perform as well as a design that would satisfy the applicable acceptable solutions in Division B, its evaluation should not be limited to comparison with the acceptable solutions to which an alternative is proposed. It is possible that acceptable solutions elsewhere in the Code also apply. The proposed alternative solution may be shown to perform as well as the most apparent acceptable solution which it is replacing but may not perform as well as other relevant acceptable solutions. For example, an innovative window assembly may perform adequately as an air barrier system but may not have adequate thermal properties. All applicable acceptable solutions should be taken into consideration in demonstrating the compliance of an alternative solution.

A-1.4.1.2.(1) Defined Terms.**Building Envelope Application**

Several types of spaces can be unconditioned and thus need to be treated differently, e.g., mechanical rooms, crawl spaces, garages, loading docks.

There is also a need to consider components that separate spaces that are conditioned to substantially different temperatures (e.g., swimming pools, skating rinks).

Gross Lighted Area

Gross lighted area cannot be tied to the building envelope because the building envelope relates only to conditioned space. Gross lighted area is used in the calculation of interior lighting power allowance, which includes all interior lighting, whether the space is conditioned or not, and some lighting of exterior spaces; lighting in elevator and service shafts, if provided at all, is not factored in since it would not have a significant impact on the interior lighting power allowance.

Interior Lighting**Building envelope**

Given the definition of building envelope, Clause (a) of the definition of interior lighting applies to lighting of all conditioned spaces.

Other sheltered spaces

Storage garages (parking garages), bus shelters and retail outlets (such as market stalls) are examples of interior spaces that are sheltered from the exterior environment and not necessarily conditioned where the interior lighting is intended only to illuminate that space.

The illumination of a covered exterior walkway may be considered exterior lighting or interior lighting, depending on whether the lighting is intended to light the area around the walkway or only the walkway itself. If only the covered walkway is illuminated, limits for lighting interior corridors would apply.

Overall Thermal Transmittance (U-value)

The overall thermal transmittance, U-value in $W/(m^2 \times K)$, is the inverse of the effective RSI in $m^2 \times K/W$. To convert RSI to an imperial R-value, use $1 m^2 \times K/W = 5.678263 h \times ft^2 \times ^\circ F/Btu$.

Storage Garage

Entrances at which vehicles stop for a short time beneath an unenclosed canopy to pick up and drop off passengers are not considered as storage garages.

Suite

Tenancy in the context of the term “suite” applies to both rental and ownership tenure. In a condominium arrangement, for example, dwelling units are considered separate suites even though they are individually owned. In order to be of complementary use, a series of rooms that constitute a suite must be in reasonably close proximity to each other and have access to each other either directly by means of a common doorway or indirectly by a corridor, vestibule or other similar arrangement.

The term “suite” does not apply to rooms such as service rooms, common laundry rooms and common recreational rooms that are not leased or under a separate tenure in the context of the Code. Similarly, the term “suite” is not normally applied in the context of buildings such as schools and hospitals, since the entire building is under a single tenure. However, a room that is individually rented is considered a suite. A warehousing unit in a mini-warehouse is a suite. A rented room in a nursing home could be considered as a suite if the room were under a separate tenure. A hospital bedroom, on the other hand, is not considered to be under a separate tenure, since the patient has little control of that space, even though he or she pays the hospital a per diem rate for the privilege of using the hospital facilities, which include the sleeping areas.

A-1.5.1.1.(1) Application of Referenced Documents. Documents referenced in the NECB may contain provisions covering a wide range of issues, including issues that are unrelated to the objectives and functional statements stated in Parts 2 and 3 of Division A respectively. Sentence 1.5.1.1.(1) is intended to make it clear that, whereas referencing these documents in the NECB generally has the effect of making the provisions of those documents part of the Code, provisions that are unrelated to buildings or to the objective and functional statements attributed to the provisions in Division B where the document is referenced are excluded.

Furthermore, many documents referenced in the NECB contain references to other documents, which may also, in turn, refer to other documents. These secondary and tertiary referenced documents may contain provisions that are unrelated to buildings or to the objectives and functional statements of the NECB: such provisions—no matter how far down the chain of references they occur—are not included in the intent of Sentence 1.5.1.1.(1).

Division A

Part 2 Objectives

2.1.	Application	
2.1.1.	Application	2-1
2.2.	Objectives	
2.2.1.	Objectives	2-1
	Notes to Part 2	2-3

Division A

Part 2 Objectives

Section 2.1. Application

2.1.1. Application

2.1.1.1. Application

- 1) This Part applies to all *buildings* covered in this Code. (See Article 1.1.1.1.)

2.1.1.2. Application of Objectives

- 1) The objectives described in this Part apply
 - a) to all *buildings* covered in this Code (see Article 1.1.1.1.), and
 - b) only to the extent that they relate to compliance with this Code as required in Article 1.2.1.1.

Section 2.2. Objectives

2.2.1. Objectives

2.2.1.1. Objectives

- 1) The objectives of this Code are as follows (see Note A-2.2.1.1.(1)):

OE Environment

An objective of this Code is to limit the probability that, as a result of the design or construction of the *building*, the environment will be affected in an unacceptable manner.

OE1 Resources

An objective of this Code is to limit the probability that, as a result of the design or construction of the *building*, resources will be used in a manner that will have an unacceptable effect on the environment. The risks of unacceptable effect on the environment due to use of resources addressed in this Code are those caused by—

- OE1.1 – excessive use of energy

Division A

Notes to Part 2 Objectives

A-2.2.1.1.(1) Objectives. Where the term “the building” is used in the wording of the objectives, it refers to the building for which compliance with the NECB is being assessed.

These Notes are included for explanatory purposes only and do not form part of the requirements. The number that introduces each Note corresponds to the applicable requirement in this Part.

Division A

Part 3

Functional Statements

3.1.	Application	
3.1.1.	Application	3-1
3.2.	Functional Statements	
3.2.1.	Functional Statements	3-1
	Notes to Part 3	3-3

Division A

Part 3 Functional Statements

Section 3.1. Application

3.1.1. Application

3.1.1.1. Application

- 1) This Part applies to all *buildings* covered in this Code. (See Article 1.1.1.1.)

3.1.1.2. Application of Functional Statements

- 1) The functional statements described in this Part apply
 - a) to all *buildings* covered in this Code (see Article 1.1.1.1.), and
 - b) only to the extent that they relate to compliance with this Code as required in Article 1.2.1.1.

Section 3.2. Functional Statements

3.2.1. Functional Statements

3.2.1.1. Functional Statements

- 1) The objectives of this Code are achieved by measures, such as those described in the acceptable solutions in Division B, that are intended to allow the *building* or its elements to perform the following functions (see Note A-3.2.1.1.(1)):

- F90** To limit the amount of uncontrolled air leakage through the *building envelope*.
- F91** To limit the amount of uncontrolled air leakage through system components.
- F92** To limit the amount of uncontrolled thermal transfer through the *building envelope*.
- F93** To limit the amount of uncontrolled thermal transfer through system components.
- F94** To limit the unnecessary demand and/or consumption of energy for lighting.
- F95** To limit the unnecessary demand and/or consumption of energy for heating and cooling.
- F96** To limit the unnecessary demand and/or consumption of energy for *service water* heating.
- F97** To limit the unnecessary demand and/or consumption of energy for electrical equipment and devices.
- F98** To limit the inefficiency of equipment.
- F99** To limit the inefficiency of systems.
- F100** To limit the unnecessary rejection of reusable waste energy.

Division A

Notes to Part 3 Functional Statements

A-3.2.1.1.(1) Listing of Functional Statements. There is a master list of functional statements covering the National Model Codes—the National Building Code, the National Fire Code, the National Plumbing Code and the National Energy Code for Buildings—but not all functional statements are pertinent to all Codes. The numbered functional statements are grouped according to functions that deal with closely related subjects.

These Notes are included for explanatory purposes only and do not form part of the requirements. The number that introduces each Note corresponds to the applicable requirement in this Part.

Division B

Acceptable Solutions



Division B

Part 1 General

1.1.	General	
1.1.1.	Application	1-1
1.1.2.	Compliance	1-1
1.1.3.	Objective and Functional Statements	1-1
1.1.4.	Basic Data and Calculation Methods	1-1
1.2.	Terms and Abbreviations	
1.2.1.	Definitions of Words and Phrases ..	1-2
1.2.2.	Symbols and Other Abbreviations ..	1-2
1.3.	Referenced Documents and Organizations	
1.3.1.	Referenced Documents	1-2
1.3.2.	Organizations	1-7
	Notes to Part 1	1-9

Division B

Part 1 General

Section 1.1. General

1.1.1. Application

1.1.1.1. Application

1) This Part applies to all *buildings* covered in this Code. (See Article 1.1.1.1. of Division A.)

1.1.2. Compliance

1.1.2.1. Prescriptive, Trade-off or Performance Compliance

(See Note A-1.1.2.1.)

- 1) *Buildings* shall comply with
- the prescriptive or trade-off requirements stated in Parts 3 to 7,
 - the performance requirements stated in Part 8, or
 - the tiered performance requirements stated in Part 10.

1.1.3. Objective and Functional Statements

1.1.3.1. Attributions to Acceptable Solutions

1) For the purpose of compliance with this Code as required in Clause 1.2.1.1.(1)(b) of Division A, the objective and functional statements attributed to the acceptable solutions in Division B shall be the objective and functional statements identified in Sections 3.5., 4.5., 5.5., 6.5., 7.5., 8.5. and 10.2. (See Note A-1.1.3.1.(1).)

1.1.4. Basic Data and Calculation Methods

1.1.4.1. Climatic Values

1) The climatic values required for the design of *buildings* under this Code shall be in conformance with the values established by the *authority having jurisdiction* or, in the absence of such data, with the climatic values in Table C-1 for the location nearest to the *building* site. (See Note A-1.1.4.1.(1).)

1.1.4.2. Calculation Procedures

1) Calculations carried out to ensure compliance with this Code and not described in the balance of this Subsection or in other Parts of the Code shall be carried out using procedures recognized for the particular purposes, such as those described in, but not limited to:

- ASHRAE Handbooks, Standards and Guidelines,
- "HRAI Digest,"
- Hydronics Institute Manuals, and
- ISO 13790, "Energy performance of buildings – Calculation of energy use for space heating and cooling."

Section 1.2. Terms and Abbreviations

1.2.1. Definitions of Words and Phrases

1.2.1.1. Non-defined Terms

1) Words and phrases used in Division B that are not included in the list of definitions in Article 1.4.1.2. of Division A shall have the meanings that are commonly assigned to them in the context in which they are used, taking into account the specialized use of terms by the various trades and professions to which the terminology applies.

2) Where objectives and functional statements are referred to in Division B, they shall be the objectives and functional statements described in Parts 2 and 3 of Division A.

3) Where acceptable solutions are referred to in Division B, they shall be the provisions stated in Parts 3 to 8 and 10.

1.2.1.2. Defined Terms

1) The words and terms in italics in Division B shall have the meanings assigned to them in Article 1.4.1.2. of Division A.

2) For the purposes of this Code, a semi-heated *building* is considered to be a *building* with a design set-point temperature of less than 15°C.

1.2.2. Symbols and Other Abbreviations

1.2.2.1. Symbols and Other Abbreviations

1) The symbols and other abbreviations in Division B shall have the meanings assigned to them in Article 1.4.2.1. of Division A and Article 1.3.2.1.

Section 1.3. Referenced Documents and Organizations

1.3.1. Referenced Documents

1.3.1.1. Effective Date

1) Unless otherwise specified herein, the documents referenced in this Code shall include all amendments, revisions, reaffirmations, reapprovals, addenda and supplements effective to 15 July 2022.

1.3.1.2. Applicable Editions

1) Where documents are referenced in this Code, they shall be the editions designated in Table 1.3.1.2. (See also Note A-1.5.1.1.(1) of Division A.)

Table 1.3.1.2.
Documents Referenced in the National Energy Code of Canada for Buildings 2020⁽¹⁾
Forming Part of Sentence 1.3.1.2.(1)

Issuing Agency	Document Number ⁽²⁾	Title of Document	Code Reference
AAMA	501.5-07	Test Method for Thermal Cycling of Exterior Walls	3.2.4.3.(3)
AHRI	ANSI/AHRI 210/240-2008	Performance Rating of Unitary Air-Conditioning and Air-Source Heat Pump Equipment	Table 5.2.12.1.-C
AHRI	AHRI 310/380-2014/CSA C744-14	Packaged Terminal Air-Conditioners and Heat Pumps	Table 5.2.12.1.-G

Table 1.3.1.2. (Continued)

Issuing Agency	Document Number ⁽²⁾	Title of Document	Code Reference
AHRI	ANSI/AHRI 340/360-2007	Performance Rating of Commercial and Industrial Unitary Air-Conditioning and Heat Pump Equipment	Table 5.2.12.1.-A Table 5.2.12.1.-C
AHRI	ANSI/AHRI 366 (SI/2009)	Performance Rating of Commercial and Industrial Unitary Air-Conditioning Condensing Units	Table 5.2.12.1.-D
AHRI	ANSI/AHRI 460-2005	Performance Rating of Remote Mechanical-Draft Air-Cooled Refrigerant Condensers	Table 5.2.12.2.
AHRI	ANSI/AHRI 551/591 (SI/2018)	Performance Rating of Water-chilling and Heat Pump Water-heating Packages Using the Vapor Compression Cycle	Table 5.2.12.1.-L Table 5.2.12.1.-M
AHRI	ANSI/AHRI 921 (SI/2015)	Performance Rating of DX-Dedicated Outdoor Air System Units	Table 5.2.12.1.-J
AHRI	1061 (SI/2013)	Performance Rating of Air-to-Air Exchangers for Energy Recovery Ventilation Equipment	5.2.10.1.(5) A-5.2.10.1.(4)
AHRI	1160 (I-P/2014)	Performance Rating of Heat Pump Pool Heaters (with Addendum 1)	Table 6.2.2.1.
AHRI	1230-2014	Performance Rating of Variable Refrigerant Flow (VRF) Multi-Split Air-Conditioning and Heat Pump Equipment (with Addendum 1)	Table 5.2.12.1.-I
AHRI	CAN/ANSI/AHRI 1330-2015	Performance Rating for Radiant Output of Gas Fired Infrared Heaters	Table 5.2.12.1.-P
AHRI	1361 (SI/2017)	Performance Rating of Computer and Data Processing Room Air Conditioners	Table 5.2.12.1.-H
AMCA	ANSI/AMCA 500-D-12	Methods of Testing Dampers for Rating	5.2.4.2.(2)
AMCA	ANSI/AMCA 500-L-12	Methods of Testing Louvers for Rating	5.2.4.2.(2)
ANSI/CSA	CSA/ANSI Z21.10.3:19/CSA 4.3:19	Gas-fired water heaters, volume III, storage water heaters with input ratings above 75,000 Btu per hour, circulating and instantaneous	Table 6.2.2.1.
ANSI/CSA	CSA/ANSI Z21.47:21/CSA 2.3:21	Gas-fired central furnaces	Table 5.2.12.1.-O
ANSI/CSA	CSA/ANSI Z21.56:19/CSA 4.7:19	Gas-fired pool heaters	Table 6.2.2.1.
ANSI/CSA	ANSI Z83.8-2016/CSA 2.6-2016	Gas unit heaters, gas packaged heaters, gas utility heaters and gas-fired duct furnaces	Table 5.2.12.1.-O
ASHRAE	2011	ASHRAE Handbook – HVAC Applications	A-6.2.4.1.(1)
ASHRAE	2013	ASHRAE Handbook – Fundamentals	3.1.1.5.(4) 3.1.1.5.(5) A-8.4.4.4.(1)
ASHRAE	ANSI/ASHRAE 55-2013	Thermal Environmental Conditions for Human Occupancy	A-5.2.8.3.(1)
ASHRAE	ANSI/ASHRAE 62.1-2016	Ventilation for Acceptable Indoor Air Quality	A-5.2.3.4.(1)
ASHRAE	ANSI/ASHRAE 84-2013	Method of Testing Air-to-Air Heat/Energy Exchangers	5.2.10.1.(5)
ASHRAE/IES	ANSI/ASHRAE/IES 90.1-2013	Energy Standard for Buildings Except Low-Rise Residential Buildings	A-Table 3.2.2.2. A-5.2.3.4.(2)
ASHRAE/IES	90.1-2013	User's Manual	A-5.2.10.1.(4) A-5.2.10.4.(5) A-6.2.3.1.(1)
ASHRAE	ANSI/ASHRAE 111-2008	Testing, Adjusting, and Balancing of Building HVAC Systems	A-5.2.5.2.(1)
ASHRAE	ANSI/ASHRAE 140-2011	Standard Method of Test for the Evaluation of Building Energy Analysis Computer Programs	8.4.2.2.(4)
ASHRAE	RP-1365-2011	Thermal Performance of Building Envelope Details for Mid- and High-Rise Buildings	A-3.1.1.5.(5)(a)

Table 1.3.1.2. (Continued)

Issuing Agency	Document Number ⁽²⁾	Title of Document	Code Reference
ASME/CSA	ASME A112.18.1-2018/CSA B125.1-18	Plumbing Supply Fittings	6.2.6.1.(1) 6.2.6.2.(1)
ASTM	C177-19	Standard Test Method for Steady-State Heat Flux Measurements and Thermal Transmission Properties by Means of the Guarded-Hot-Plate Apparatus	3.1.1.5.(1)
ASTM	C335/C335M-17	Standard Test Method for Steady-State Heat Transfer Properties of Pipe Insulation	5.2.5.3.(6) 6.2.3.1.(4)
ASTM	C518-21	Standard Test Method for Steady-State Thermal Transmission Properties by Means of the Heat Flow Meter Apparatus	3.1.1.5.(1)
ASTM	C1363-19	Standard Test Method for Thermal Performance of Building Materials and Envelope Assemblies by Means of a Hot Box Apparatus	3.1.1.5.(4) 3.1.1.5.(5)
ASTM	E283/E283M-19	Standard Test Method for Determining Rate of Air Leakage Through Exterior Windows, Skylights, Curtain Walls, and Doors Under Specified Pressure Differences Across the Specimen	3.2.4.3.(3) 3.2.4.3.(6) 3.2.4.3.(7) 3.2.4.3.(8) 3.2.4.3.(9)
ASTM	E779-19	Standard Test Method for Determining Air Leakage Rate by Fan Pressurization	8.4.2.9.(2)
ASTM	E3158-18	Standard Test Method for Measuring the Air Leakage Rate of a Large or Multizone Building	3.2.4.2.(1)
BC Hydro	2014	Building Envelope Thermal Bridging Guide	A-3.1.1.5.(5)(a)
CCBFC	NRCC-CONST-56435E	National Building Code of Canada 2020	1.1.1.1.(1) ⁽³⁾ 1.1.1.3.(1) ⁽³⁾ 1.1.1.3.(2) ⁽³⁾ 1.4.1.2.(1) ⁽³⁾ A-3.2.1.1.(1) ⁽³⁾ 3.1.1.5.(1) A-3.2.3.1.(3) 5.2.1.1.(1) 5.2.2.1.(1) 5.2.2.8.(2) 5.2.5.1.(1) A-5.2.2.8.(2) A-5.2.8.4.(1) A-5.2.10.4.(1) A-5.2.10.4.(5)
CCBFC	NRCC-CONST-56437E	National Fire Code of Canada 2020	1.4.1.2.(1) ⁽³⁾ A-3.2.1.1.(1) ⁽³⁾
CCBFC	NRCC-CONST-56436E	National Plumbing Code of Canada 2020	A-3.2.1.1.(1) ⁽³⁾ A-5.2.10.4.(1) 6.2.1.1.(1) A-6.2.6.1.(1) A-8.4.4.20.(6) A-8.4.4.20.(7)
CSA	AAMA/WDMA/CSA 101/I.S.2/A440-17	North American Fenestration Standard/Specification for windows, doors, and skylights	3.2.4.3.(4) 3.2.4.3.(5)
CSA	A440.2:19/A440.3:19	Fenestration energy performance/User guide to CSA A440.2:19, Fenestration energy performance	3.1.1.5.(3) A-3.1.1.6.(1)
CSA	B140.4:04	Oil-Fired Warm Air Furnaces	Table 5.2.12.1.-O
CSA	B140.12-03	Oil-Burning Equipment: Service Water Heaters for Domestic Hot Water, Space Heating, and Swimming Pools	Table 6.2.2.1.
CSA	CAN/CSA-B211-00	Energy Efficiency of Oil-Fired Storage Tank Water Heaters	Table 6.2.2.1.

Table 1.3.1.2. (Continued)

Issuing Agency	Document Number ⁽²⁾	Title of Document	Code Reference
CSA	B415.1:22	Performance testing of solid-biofuel-burning heating appliances	Table 5.2.12.1.-P
CSA	C22.1:21	Canadian Electrical Code, Part I	A-7.2.1.1.
CSA	CAN/CSA-C191-13	Performance of Electric Storage Tank Water Heaters for Domestic Hot Water Service	Table 6.2.2.1.
CSA	C368.1:14	Energy performance of room air conditioners	Table 5.2.12.1.-G
CSA	C390:10	Test methods, marking requirements, and energy efficiency levels for three-phase induction motors	7.2.4.1.(1)
CSA	CAN/CSA-C439-18	Laboratory methods of test for rating the performance of heat/energy-recovery ventilators	5.2.10.1.(5) 5.2.10.4.(2) Table 5.2.10.4. A-5.2.10.4.(2)
CSA	CAN/CSA-C654-14	Fluorescent lamp ballast efficacy measurements	4.2.1.2.(1) 4.2.1.2.(2)
CSA	C656-14	Performance standard for split-system and single-package air conditioners and heat pumps	Table 5.2.12.1.-A Table 5.2.12.1.-I
CSA	CAN/CSA-C743-09	Performance standard for rating packaged water chillers	Table 5.2.12.1.-K Table 5.2.12.1.-L
CSA	CAN/CSA-C745-20	Energy efficiency of electric storage tank water heaters and heat pump water heaters	Table 6.2.2.1.
CSA	CAN/CSA-C746-17	Energy performance rating for large and single packaged vertical air conditioners and heat pumps	Table 5.2.12.1.-A Table 5.2.12.1.-B Table 5.2.12.1.-C Table 5.2.12.1.-D
CSA	C748-13	Performance of direct-expansion (DX) ground-source heat pumps	Table 5.2.12.1.-F
CSA	CAN/CSA-C802.1-13	Minimum efficiency values for liquid-filled distribution transformers	7.2.3.1.(1)
CSA	CAN/CSA-C802.2-18	Test method and minimum efficiency values for dry-type transformers	7.2.3.1.(1)
CSA	C802.3-15	Minimum efficiency values for power transformers	7.2.3.1.(1)
CSA	CAN/CSA-C828:19	Performance requirements for line voltage thermostats used with individual room electric space heating devices	5.2.8.6.(4)
CSA	CAN/CSA-C860-11	Performance of internally lighted exit signs	4.2.1.1.(1)
CSA	C873.4:15	Building energy estimation methodology – Part 4 – Energy consumption for lighting	4.3.1.3.(1) 4.3.1.3.(2) 4.3.1.3.(3) 4.3.1.3.(4) 4.3.1.3.(5)
CSA	CAN/CSA-C13256-1-01	Water-Source Heat Pumps - Testing and Rating for Performance - Part 1: Water-to-Air and Brine-to-Air Heat Pumps (Adopted ISO 13256-1:1998, first edition, 1998-08-15, with Canadian Deviations)	Table 5.2.12.1.-E
CSA	CAN/CSA-C13256-2-01	Water-Source Heat Pumps - Testing and Rating for Performance - Part 2: Water-to-Water and Brine-to-Water Heat Pumps (Adopted ISO 13256-2:1998, first edition, 1998-08-15, with Canadian Deviations)	Table 5.2.12.1.-E
CSA	CAN/CSA-F379 SERIES-09 (excluding Supplement F379S1-11)	Packaged solar domestic hot water systems (liquid-to-liquid heat transfer)	6.2.2.3.(1)

Table 1.3.1.2. (Continued)

Issuing Agency	Document Number ⁽²⁾	Title of Document	Code Reference
CSA	CAN/CSA-P2-13	Testing method for measuring the annual fuel utilization efficiency of residential gas-fired or oil-fired furnaces and boilers	Table 5.2.12.1.-N Table 5.2.12.1.-O
CSA	CAN/CSA-P3-15	Testing method for measuring energy consumption and determining efficiencies of gas-fired and fuel oil-fired water heaters	Table 6.2.2.1.
CSA	CAN/CSA-P4.1:21	Testing method for measuring fireplace efficiency	Table 5.2.12.1.-P
CSA	P6-09	Test method for measuring thermal efficiency of gas-fired pool heaters	Table 6.2.2.1.
CSA	CAN/CSA-P8-09	Thermal efficiencies of industrial and commercial gas-fired package furnaces	Table 5.2.12.1.-O
CSA	CAN/CSA-P11-07	Testing Method for Measuring Efficiency and Energy Consumption of Gas-Fired Unit Heaters	Table 5.2.12.1.-O
CTI	STD-201RS-04	Standard for the Certification of Water Cooling Tower Thermal Performance	Table 5.2.12.2.
CTI	ATC-105-00	Acceptance Test Code	Table 5.2.12.2.
CTI	ATC-105DS-18	Acceptance Test Code for Dry Fluid Coolers	Table 5.2.12.2.
CTI	ATC-105S-11	Acceptance Test Code for Closed Circuit Cooling Towers	Table 5.2.12.2.
CTI	ATC-106-11	Acceptance Test Code for Mechanical Draft Evaporative Vapor Condensers	Table 5.2.12.2.
DASMA	ANSI/DASMA 105-2017	Test Method for Thermal Transmittance and Air Infiltration of Garage Doors	3.2.4.3.(8)
DIN	EN 303-5:2012	Heating boilers – Part 5: Heating boilers for solid fuels, manually and automatically stoked, nominal heat output of up to 500 kW – Terminology, requirements, testing and marking; German version EN 303-5:2012	Table 5.2.12.1.-P
DIN	EN 416:2019	Gas-fired overhead radiant tube heaters and radiant tube heater systems for non-domestic use – Safety and energy efficiency; German version EN 416:2019	Table 5.2.12.1.-P
DIN	EN 419:2019	Gas-fired overhead luminous radiant heaters for non-domestic use – Safety and energy efficiency; German version EN 419:2019	Table 5.2.12.1.-P
DOE	10 CFR, Part 430-2011	Energy, Energy Conservation Program for Consumer Products	Table 5.2.12.1.-O Table 6.2.2.1.
DOE	10 CFR, Part 431-2011	Energy, Energy Efficiency Program for Certain Commercial and Industrial Equipment	Table 5.2.12.1.-N Table 6.2.2.1.
EPA	40 CFR, Part 60-2008	Protection of Environment, Standards of Performance for New Stationary Sources	Table 5.2.12.1.-P
HRAI	2017 Edition	HRAI Digest	1.1.4.2.(1) A-5.2.1.1.(1)
HVI	HVI Publication 911	Certified Home Ventilating Products Directory	A-5.2.10.4.(2)
ICC/SRCC	ICC 900/SRCC 300-2015	Solar Thermal System Standard	Table 6.2.2.1.
IES	HB-10-11	The Lighting Handbook, 10th Edition	A-Table 4.3.2.8.
IES	ANSI/IES RP-28-07	Lighting and the Visual Environment for Senior Living	Table 4.2.1.6. Table 4.3.2.10.-A A-8.4.3.2.(2)
ISO	13790:2008	Energy performance of buildings – Calculation of energy use for space heating and cooling	1.1.4.2.(1)
ISO	14683:2007	Thermal bridges in building construction – Linear thermal transmittance – Simplified methods and default values	3.1.1.5.(5)

Table 1.3.1.2. (Continued)

Issuing Agency	Document Number ⁽²⁾	Title of Document	Code Reference
NEMA	ANSI_ANSLG C82.11:2011	American National Standard for Lamp Ballasts–High-Frequency Fluorescent Lamp Ballasts	4.2.1.2.(2)
NFRC	100-2010	Procedure for Determining Fenestration Product U-factors	3.1.1.5.(3)
NRCan	S.C. 1992, c. 36	Energy Efficiency Act	5.2.12.4.(1) A-5.2.12.1.(1) and 6.2.2.1.(1) 6.2.2.4.(2) 6.2.2.5.(1)
NRCan	SOR/2016-311	Energy Efficiency Regulations	Table 5.2.12.1.-A Table 5.2.12.1.-B Table 5.2.12.1.-C Table 5.2.12.1.-D Table 5.2.12.1.-E Table 5.2.12.1.-G Table 5.2.12.1.-I Table 5.2.12.1.-K Table 5.2.12.1.-N Table 5.2.12.1.-O 5.2.12.4.(1) A-5.2.12.1.(1) and 6.2.2.1.(1) Table 6.2.2.1. 6.2.2.4.(2) 6.2.2.5.(1)
SMACNA	ANSI/SMACNA 006-2006	HVAC Duct Construction Standards – Metal and Flexible	5.2.2.3.(1) Table 5.2.2.3. A-5.2.2.1.(1)
SMACNA	ANSI/SMACNA 016-2012	HVAC Air Duct Leakage Test Manual	5.2.2.4.(1) A-5.2.2.1.(1)
SMACNA	2003	Fibrous Glass Duct Construction Standards	A-5.2.2.1.(1)
SMACNA	2006	HVAC Systems Duct Design	A-5.2.2.1.(1)
TIAC	2013	Mechanical Insulation Best Practices Guide	A-5.2.2.5.(8) and 5.2.5.3.(7)
ULC	CAN/ULC-S741-08	Standard for Air Barrier Materials – Specification	3.2.4.3.(2)
ULC	CAN/ULC-S742:2020	Standard for Air Barrier Assemblies – Specification	3.2.4.3.(2) A-3.2.4.3.(1) and (2)

Notes to Table 1.3.1.2.:

- (1) While every effort was made to ensure the accuracy of the information in this Table, the NRC is not responsible for the accuracy, timeliness or reliability of the content presented therein. For all purposes of interpreting and applying the referenced standards, Code users should refer to the most recent official versions of the referenced editions.
- (2) Some documents may have been reaffirmed or reapproved. Check with the applicable issuing agency for up-to-date information.
- (3) Code reference is in Division A.

1.3.2. Organizations

1.3.2.1. Abbreviations of Proper Names

1) The abbreviations of proper names in this Code shall have the meanings assigned to them in this Article.

AAMA Fenestration and Glazing Industry Alliance (formerly American Architectural Manufacturers Association) (www.fgiaonline.org)

AHRI	Air-Conditioning, Heating and Refrigeration Institute (www.ahrinet.org)
AMCA	Air Movement and Control Association (www.amca.org)
ANSI	American National Standards Institute (www.ansi.org)
ANSLG	American National Standards Lighting Group (see NEMA)
ASHRAE	American Society of Heating, Refrigerating and Air-Conditioning Engineers (www.ashrae.org)
ASME	American Society of Mechanical Engineers (www.asme.org)
ASTM	ASTM International (www.astm.org)
CAN	National Standard of Canada designation (www.scc.ca)
CBHCC	Canadian Board for Harmonized Construction Codes (cbhcc-cchcc.ca)
CCBFC	Canadian Commission on Building and Fire Codes (see NRC)
CSA	CSA Group (www.csagroup.ca)
CTI	Cooling Technology Institute (www.coolingtechnology.org)
DASMA	Door and Access Systems Manufacturers Association International (www.dasma.com/dasma-standards)
DIN	Deutsches Institut für Normung e. V. (German Institute for Standardization) (www.din.de/en)
DOE	U.S. Department of Energy (www.energy.gov)
EPA	Environmental Protection Agency (U.S.) (www.epa.gov)
HRAI	Heating, Refrigeration and Air Conditioning Institute of Canada (www.hrai.ca)
HVI	Home Ventilating Institute (www.hvi.org)
ICC	International Code Council (www.iccsafe.org)
IES	Illuminating Engineering Society (www.ies.org)
ISO	International Organization for Standardization (www.iso.org)
NBC	National Building Code of Canada 2020
NECB	National Energy Code of Canada for Buildings 2020
NEMA	National Electrical Manufacturers Association (www.nema.org)
NFC	National Fire Code of Canada 2020
NFRC	National Fenestration Rating Council (www.nfrc.org)
NPC	National Plumbing Code of Canada 2020
NRC	National Research Council of Canada (nrc.canada.ca)
NRCan	Natural Resources Canada (www.nrcan.gc.ca)
SMACNA	Sheet Metal and Air Conditioning Contractors' National Association (www.smacna.org)
SRCC	Solar Rating & Certification Corporation (www.solar-rating.org)
TIAC	Thermal Insulation Association of Canada (www.tiac.ca)
ULC	ULC Standards (canada.ul.com/ulcstandards)
WDMA	Window & Door Manufacturers Association (www.wdma.com)

Division B

Notes to Part 1 General

A-1.1.2.1. NECB Compliance Options. Figure A-1.1.2.1. shows the three compliance options available in Division B.

These Notes are included for explanatory purposes only and do not form part of the requirements. The number that introduces each Note corresponds to the applicable requirement in this Part.

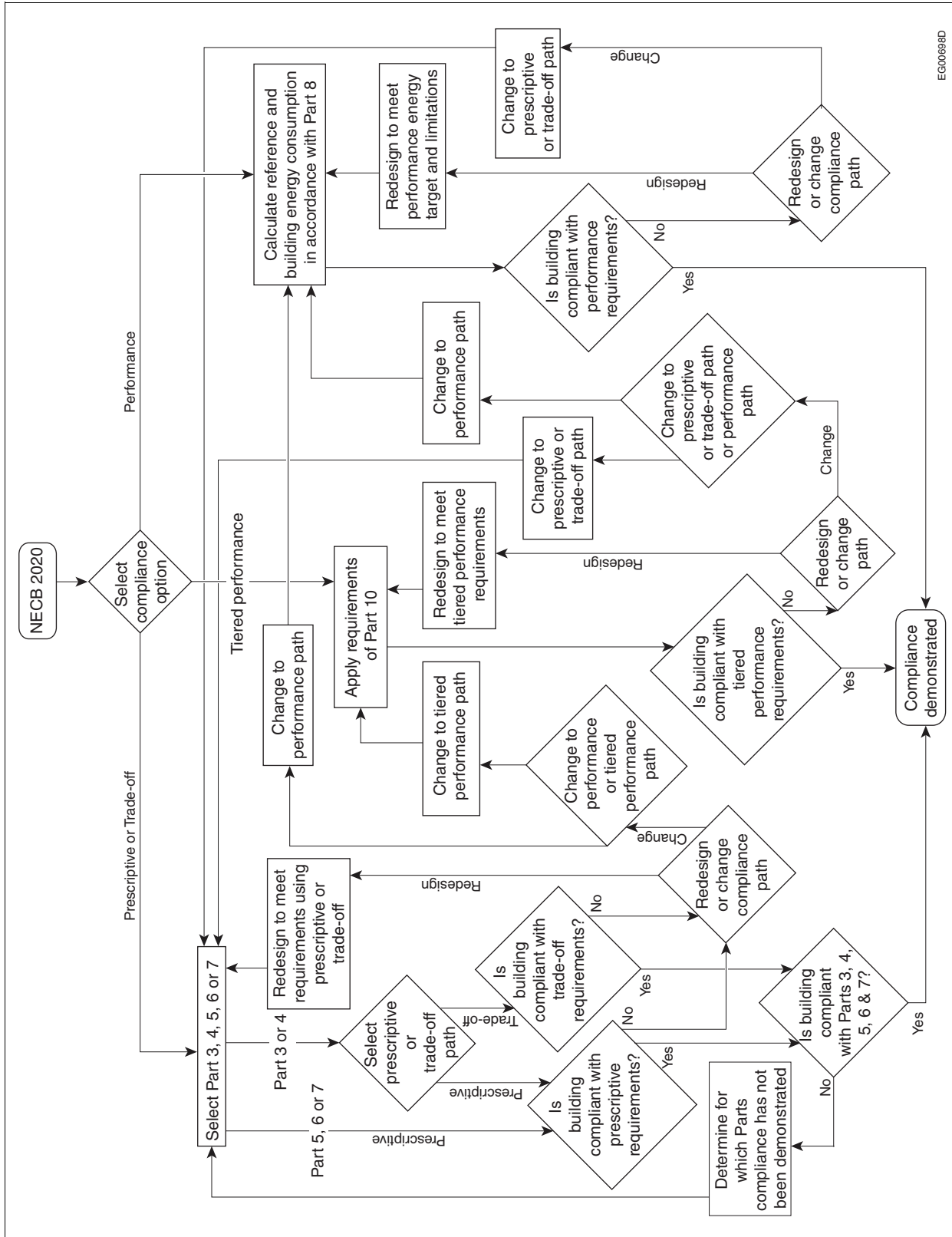

EG00699D

Figure A-1.1.2.1. Decision flow chart for code compliance

Prescriptive Path

The first compliance option is to apply the prescriptive requirements of the Code, which generally dictate minimum thermal characteristics for envelope elements and energy efficiency measures that can be stated as specific instructions.

Trade-off Path

The second option affords some degree of flexibility in the application of the prescriptive requirements. For example, the trade-off path for Part 3 allows Code users to vary the thermal characteristics of one or more components of the building envelope and/or vary the fenestration and door area from that permitted in Section 3.2., provided it can be demonstrated that the resultant building envelope will not transfer more energy than it would if all its components complied with that Section. The trade-off option presents an easy way to make small adjustments to the characteristics of the building without having to follow the whole-building performance route.

Performance Path

The third option is a performance path: if some aspects of the prescriptive and trade-off routes are considered too limiting, the building could, for example, be designed with any thermal characteristics desired (subject to certain limitations), provided that it would not have a calculated energy consumption under standardized conditions that is greater than it would have had the building been designed in strict conformity with the prescriptive requirements, all other aspects of the building (those that are not the object of a requirement in this Code) remaining the same in both cases. The proof of compliance when using the performance path option is achieved through two energy analyses: one on the building as if it met the prescriptive requirements, which gives the “target” performance, and the other on the actual design for which a building permit is requested.

A-1.1.3.1.(1) Objective and Functional Statements Attributed to Acceptable

Solutions. The objective and functional statements attributed to each Code provision are shown in Tables at the end of each Part in Division B.

Many provisions in Division B serve as modifiers of or pointers to other provisions, or serve other clarification or explanatory purposes. In most cases, no objective and functional statements have been attributed to such provisions, which therefore do not appear in the above-mentioned tables.

For provisions that serve as modifiers of or pointers to other referenced provisions and that do not have an objective and functional statements attributed to them, the objective and functional statements that should be used are those attributed to the provisions they reference.

A-1.1.4.1.(1) Climatic Values. Climatic values for municipalities not listed in Table C-1 may be obtained at www.climate.weather.gc.ca/index_e.html.

Hourly climatic values are available from multiple sources such as Environment and Climate Change Canada, Natural Resources Canada, the Regional Conservation Authority and other such public agencies that record this type of information. Hourly weather data are also available from public and private agencies that format this information for use with annual energy consumption simulation software; in some cases, these data have been incorporated into the software.

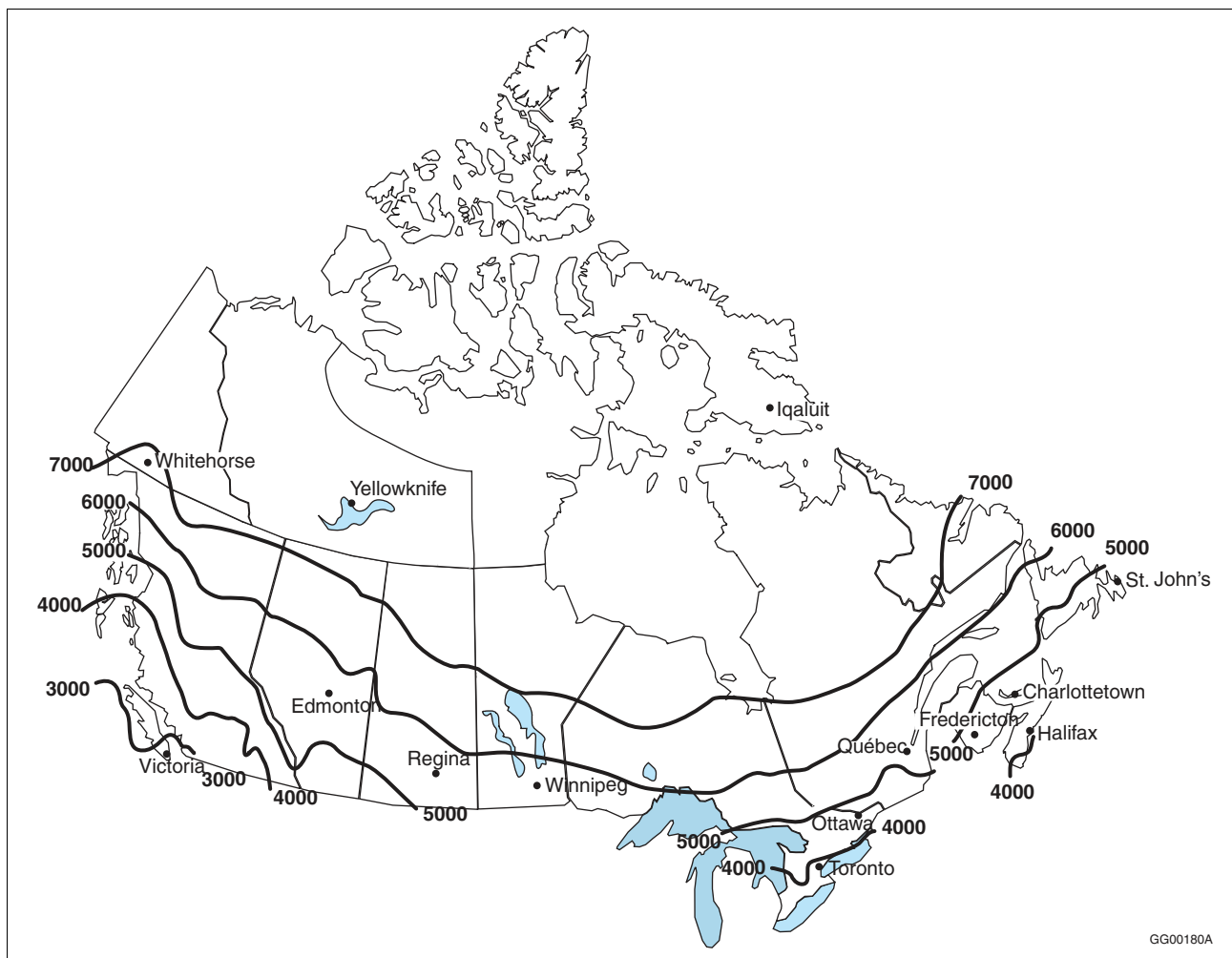

GG00180A

Figure A-1.1.4.1.(1)
Contour map showing approximate average annual heating degree-days taken at 18°C

Division B

Part 2
Reserved

Division B

Part 3 Building Envelope

3.1.	General	
3.1.1.	General	3-1
3.2.	Prescriptive Path	
3.2.1.	General	3-3
3.2.2.	Above-ground Components of the Building Envelope	3-4
3.2.3.	Building Assemblies in Contact with the Ground	3-6
3.2.4.	Air Leakage	3-8
3.3.	Trade-off Path	
3.3.1.	Simple Trade-off Path	3-9
3.4.	Performance Path	
3.4.1.	General	3-10
3.5.	Objective and Functional Statements	
3.5.1.	Objective and Functional Statements	3-11
	Notes to Part 3	3-13

Division B

Part 3 Building Envelope

Section 3.1. General

3.1.1. General

3.1.1.1. Scope

- 1) This Part is concerned with the transfer of heat and air through
 - a) *building* materials, components and assemblies forming part of the *building envelope*, and
 - b) interfaces between *building* materials, components and assemblies forming part of the *building envelope*.

3.1.1.2. Application

- 1) This Part applies to the *building envelope* in *buildings*
 - a) that are equipped with space-conditioning systems or have provisions for the future installation of such systems (see Note A-3.1.1.2.(1)(a)), and
 - b) whose heating and/or cooling system output capacity is equal to or greater than 10 W/m² of *floor surface area*.

3.1.1.3. Compliance

- 1) Compliance with this Part shall be achieved by following
 - a) the prescriptive path described in Section 3.2.,
 - b) the trade-off path described in Section 3.3., or
 - c) the performance path described in Section 3.4. (see Note A-3.1.1.3.(1)(c)).(See Note A-3.1.1.3.(1).)

3.1.1.4. Definitions

- 1) Words that appear in italics are defined in Article 1.4.1.2. of Division A.

3.1.1.5. Thermal Characteristics of Building Assemblies

(See Note A-3.1.1.5.)

- 1) The thermal characteristics of *building envelope* materials shall be determined in accordance with the applicable product standards listed in the NBC or, in the absence of such standards or where such standards do not address the determination of thermal characteristics, in accordance with
 - a) ASTM C177, "Standard Test Method for Steady-State Heat Flux Measurements and Thermal Transmission Properties by Means of the Guarded-Hot-Plate Apparatus," or
 - b) ASTM C518, "Standard Test Method for Steady-State Thermal Transmission Properties by Means of the Heat Flow Meter Apparatus."
- 2) Calculations and tests performed in accordance with Sentence (1) shall be carried out at an average temperature of 24±2°C and under a temperature difference of 22±2°C.

- 3)** Except as provided in Sentence (4), the *overall thermal transmittance* of *fenestration* and doors shall be determined for the reference sizes listed in accordance with
- CSA A440.2/A440.3, "Fenestration energy performance/User guide to CSA A440.2:19, Fenestration energy performance," or
 - NFRC 100, "Procedure for Determining Fenestration Product U-factors."
- 4)** The *overall thermal transmittance* of *fenestration* and doors that are not within the scope of the standards listed in Sentence (3) shall be determined from
- calculations carried out using the procedures described in the "ASHRAE Handbook – Fundamentals," or
 - laboratory tests performed in accordance with ASTM C1363, "Standard Test Method for Thermal Performance of Building Materials and Envelope Assemblies by Means of a Hot Box Apparatus," using an indoor air temperature of $21\pm 1^\circ\text{C}$ and an outdoor air temperature of $-18\pm 1^\circ\text{C}$ measured at the mid-height of the *fenestration* or door.
- 5)** The thermal characteristics of *building* assemblies other than *fenestration* and doors shall be determined from
- calculations carried out using the procedures described in
 - the "ASHRAE Handbook – Fundamentals," or
 - ISO 14683, "Thermal bridges in building construction – Linear thermal transmittance – Simplified methods and default values,"
 (see Note A-3.1.1.5.(5)(a)),
 - two- or three-dimensional thermal modeling, or
 - laboratory tests performed in accordance with ASTM C1363, "Standard Test Method for Thermal Performance of Building Materials and Envelope Assemblies by Means of a Hot Box Apparatus," using an indoor air temperature of $21\pm 1^\circ\text{C}$ and an outdoor air temperature of $-18\pm 1^\circ\text{C}$.

3.1.1.6. Calculation of Fenestration and Door Areas

- 1)** *Fenestration* and door areas shall be calculated to the rough opening in the wall and shall include all related *frame* and *sash* members. (See Note A-3.1.1.6.(1).)
- 2)** The *fenestration* area made of flat panes that are not all in the same plane or curved panes shall be measured along the surface of the glass. (See Note A-3.1.1.6.(2).)
- 3)** Except as provided in Sentence (4), in the calculation of allowable *fenestration* and door area, the gross wall area shall be calculated as the sum of the areas of all above-ground wall assemblies including *fenestration* and doors, but not including parapets, projected fins, ornamentation and appendages.
- 4)** The calculation of allowable *fenestration* and door area in *additions* shall be based upon
- the *addition* being considered by itself, or
 - the *addition* being considered together with the existing *building*, provided that the combined *overall thermal transmittance* of the *addition* and existing *building* meets the prescriptive or trade-off requirements.
- 5)** In the calculation of allowable *skylight* area, the gross roof area shall be calculated as the sum of the areas of insulated roof including *skylights*.

3.1.1.7. Calculation of Overall Thermal Transmittance

- 1)** In calculating the *overall thermal transmittance* of assemblies for purposes of comparison with the provisions in Section 3.2., the effect of thermal bridging shall be considered for
- closely spaced repetitive structural members, such as studs and joists, and ancillary members, such as lintels, sills and plates,
 - major structural elements that penetrate or intersect the *building envelope* (see Note A-3.1.1.7.(1)(b)),
 - the junctions between the following *building envelope* materials, components, and assemblies:
 - glazing assemblies,

- ii) spandrels,
 - iii) parapets,
 - iv) roof-to-wall junctions,
 - v) corners, and
 - vi) edges of walls or floors, and
- d) secondary structural members (see Note A-3.1.1.7.(1)(d)).

2) In calculating the *overall thermal transmittance* of assemblies for purposes of comparison with the provisions in Section 3.2., pipes, ducts, equipment with through-the-wall venting, packaged terminal air conditioners or heat pumps need not be taken into account. (See Note A-3.1.1.7.(2).)

3) In calculating the *overall thermal transmittance* of assemblies for purposes of comparison with the provisions in Section 3.2., fasteners need not be taken into account.

4) Where a component of the *building envelope* is protected by an enclosed unconditioned space, such as a sun porch, enclosed veranda or vestibule, the unconditioned enclosure may be considered to have an *overall thermal transmittance* of $6.25 \text{ W}/(\text{m}^2 \times \text{K})$. (See Note A-3.1.1.7.(4).)

5) For the purposes of this Article, roof assemblies shall be considered to include all related structural framing.

6) For the purposes of this Article, wall assemblies inclined less than 60° from the horizontal shall be considered as roof assemblies, and roof assemblies inclined 60° or more from the horizontal shall be considered as wall assemblies.

7) For the purposes of this Article, wall assemblies shall be considered to include all related structural framing and perimeter areas of intersecting interior walls.

8) For the purposes of this Article, floor assemblies shall be considered to include all related structural framing.

Section 3.2. Prescriptive Path

3.2.1. General

3.2.1.1. Protection of Insulation Materials

1) Except as provided in Sentence (2), the *building envelope* shall be designed to avoid increasing the *overall thermal transmittance* of the insulation material due to

- a) air leakage or convection,
- b) wetting, or
- c) moisture bypassing the plane of thermal resistance.

(See Note A-3.2.1.1.(1).)

2) Where any of the conditions described in Clauses (1)(a) to (c) occur as a result of the designed *building envelope* system, their effect on the *overall thermal transmittance* of the insulation material shall be calculated in accordance with Article 3.1.1.5.

3.2.1.2. Continuity of Insulation

1) Where mechanical ducts and chases or electrical system components, such as pipes, ducts, conduits, cabinets, panels, or recessed heaters, are placed within and parallel to the *building envelope*, the *overall thermal transmittance* of the *building envelope* at the projected area of the mechanical or electrical system components shall not be increased.

2) Joints between components of the *building envelope*, such as expansion or construction joints or joints between walls and doors or *fenestration*, shall be insulated in a manner that provides continuity across such joints. (See Note A-3.2.1.2.(2).)

3.2.1.3.**3.2.1.3. Spaces Heated to Different Temperatures**

1) The overall thermal transmittance, U_1 , of building assemblies separating conditioned spaces that are intended to be heated to temperatures that differ by more than 10°C shall not be greater than that obtained with the following equation:

$$U_1 = [(t_2 - t_0) / (t_2 - 0.5 \times t_1 - 0.5 \times t_0)] \times U$$

where

- t_1 = indoor heating design temperature of the colder conditioned space, in °C,
- t_2 = indoor heating design temperature of the warmer conditioned space, in °C,
- t_0 = outdoor 2.5% January design temperature as specified in Article 1.1.4.1., in °C, and
- U = overall thermal transmittance required in Sentences 3.2.2.2.(1), 3.2.2.3.(2) and 3.2.2.4.(1), in W/(m²×K).

(See Note A-3.2.1.3.(1).)

3.2.1.4. Allowable Fenestration and Door Area

1) The maximum allowable total vertical fenestration and door area to gross wall area ratio (FDWR), determined in accordance with Article 3.1.1.6., shall be as follows:

$$\begin{aligned} \text{FDWR} &= 0.40 \text{ for } \text{HDD} \leq 4000, \\ \text{FDWR} &= (2000 - 0.2 \times \text{HDD}) / 3000 \text{ for } 4000 < \text{HDD} < 7000, \text{ and} \\ \text{FDWR} &= 0.20 \text{ for } \text{HDD} \geq 7000, \end{aligned}$$

where

HDD = the heating degree-days of the location of the building determined according to Sentence 1.1.4.1.(1).

(See Note A-3.2.1.4.(1).)

2) The total skylight area shall be less than 2% of the gross roof area as determined in Article 3.1.1.6.

3.2.2. Above-ground Components of the Building Envelope**3.2.2.1. Vestibules**

1) Except as provided in Sentence (3), a door that separates conditioned space from the exterior shall be protected with an enclosed vestibule whose doors opening into and out of the vestibule are equipped with self-closing devices.

2) Except for doors equipped with power operators in barrier-free entrances, vestibules required in Sentence (1) shall be designed so that users passing through the vestibule are not required to open the interior and exterior doors at the same time.

- 3)** A vestibule is not required for an exterior door that
- a) is a revolving door,
 - b) is used primarily to facilitate vehicular movement or material handling,
 - c) is intended to be used as a service, emergency exit, or stairwell exit door only,
 - d) is intended to be used as a seasonal use door, such as a door leading to a patio,
 - e) opens directly from a dwelling unit,
 - f) opens directly from a retail space less than 200 m² in area or from a space less than 150 m² for other uses, or
 - g) is located in a building less than 5 storeys in building height in any area that has fewer than 3500 heating degree-days (°C) as listed in Table C-1.

3.2.2.2. Thermal Characteristics of Above-ground Opaque Building Assemblies

1) Except as provided in Sentences (3) and (4) and in Sentence 3.2.1.3.(1), the overall thermal transmittance of above-ground opaque building assemblies shall be not

more than that shown in Table 3.2.2.2. for the *building* or part thereof enclosed by the *opaque building assembly*, for the applicable heating degree-day category taken at 18°C. (See Note A-3.2.2.2.(1).)

Table 3.2.2.2.
Overall Thermal Transmittance of Above-ground Opaque Building Assemblies
 Forming Part of Sentences 3.2.2.2.(1) and (2)

Above-ground Opaque Building Assembly	Heating Degree-Days of <i>Building</i> Location, ⁽¹⁾ in Celsius Degree-Days					
	Zone 4: ⁽²⁾ < 3000	Zone 5: ⁽²⁾ 3000 to 3999	Zone 6: ⁽²⁾ 4000 to 4999	Zone 7A: ⁽²⁾ 5000 to 5999	Zone 7B: ⁽²⁾ 6000 to 6999	Zone 8: ⁽²⁾ ≥ 7000
	Maximum <i>Overall Thermal Transmittance</i> , W/(m ² ·K)					
Walls	0.290	0.265	0.240	0.215	0.190	0.165
Roofs	0.164	0.156	0.138	0.121	0.117	0.110
Floors	0.193	0.175	0.156	0.138	0.121	0.117

Notes to Table 3.2.2.2.:

- (1) See Sentence 1.1.4.1.(1).
- (2) See Note A-Table 3.2.2.2.

2) Except as provided in Sentences (3), (4) and 3.2.1.3.(1), the *overall thermal transmittance* of above-ground *opaque building assemblies* in semi-heated *buildings*, as defined in Sentence 1.2.1.2.(2), shall be not more than that shown in Table 3.2.2.2. for the *building* or part thereof enclosed by the *opaque building assembly*, for the applicable heating degree-day category taken at 15°C.

3) The *overall thermal transmittance* of portions of a *foundation* wall that are above ground, where the top of a *foundation* wall is less than 0.4 m above the adjoining ground level, shall be not more than that shown in Table 3.2.3.1.

4) Where radiant heating cables or heating or cooling pipes or membranes are embedded in the surface of an above-ground *opaque building assembly*, this assembly shall have an *overall thermal transmittance* no greater than 80% of that required by Sentence (1). (See Note A-3.2.2.2.(4).)

3.2.2.3. Thermal Characteristics of Fenestration

1) For the purposes of this Article, the term “*fenestration*” does not include doors, which are covered in Article 3.2.2.4.

2) Except as provided in Sentences (3) and 3.2.1.3.(1), the *overall thermal transmittance* of *fenestration* shall be not more than that shown in Table 3.2.2.3. for the applicable heating degree-day category taken at 18°C, as determined in accordance with Article 3.1.1.5.

3) Except as provided in Sentence 3.2.1.3.(1), the *overall thermal transmittance* of *fenestration* in semi-heated *buildings*, as defined in Sentence 1.2.1.2.(2), shall be not more than that shown in Table 3.2.2.3. for the applicable heating degree-day category taken at 15°C, as determined in accordance with Article 3.1.1.5.

Table 3.2.2.3.
Overall Thermal Transmittance of Fenestration
 Forming Part of Sentences 3.2.2.3.(2) and (3)

Component	Heating Degree-Days of <i>Building</i> Location, ⁽¹⁾ in Celsius Degree-Days					
	Zone 4: ⁽²⁾ < 3000	Zone 5: ⁽²⁾ 3000 to 3999	Zone 6: ⁽²⁾ 4000 to 4999	Zone 7A: ⁽²⁾ 5000 to 5999	Zone 7B: ⁽²⁾ 6000 to 6999	Zone 8: ⁽²⁾ ≥ 7000
	Maximum <i>Overall Thermal Transmittance</i> , W/(m ² ×K)					
Vertical <i>fenestration</i>	1.90	1.90	1.73	1.73	1.44	1.44
<i>Skylights</i>	2.69	2.69	2.41	2.41	2.01	2.01

Notes to Table 3.2.2.3.:

(1) See Sentence 1.1.4.1.(1).

(2) See Note A-Table 3.2.2.2.

3.2.2.4. Thermal Characteristics of Doors and Access Hatches

1) Except as provided in Sentences (2), (3), (5) and 3.2.1.3.(1), the *overall thermal transmittance* of doors shall be not more than that shown in Table 3.2.2.4. for the applicable heating degree-day category taken at 18°C, as determined in accordance with Article 3.1.1.5.

2) Except as provided in Sentences (3) and (5), the *overall thermal transmittance* of doors in semi-heated *buildings*, as defined in Sentence 1.2.1.2.(2), shall be not more than that shown in Table 3.2.2.4. for the applicable heating degree-day category taken at 15°C, as determined in accordance with Article 3.1.1.5.

- 3)** Doors need not comply with Sentence (1) or (2) where
- their total area does not exceed 2% of the gross wall area calculated in accordance with Article 3.1.1.6., and
 - their *overall thermal transmittance* does not exceed 4.4 W/(m²×K).

4) Access hatches that are part of a *building envelope* shall be insulated to a nominal thermal transmittance of not more than 1.3 W/(m²×K), exclusive of stiffeners or edge construction.

5) Storm doors, automatic sliding glass doors, revolving doors, and fire shutters need not comply with Sentence (1) or (2). (See Note A-3.2.2.4.(5).)

Table 3.2.2.4.
Overall Thermal Transmittance of Doors
 Forming Part of Sentences 3.2.2.4.(1) and (2)

Component	Heating Degree-Days of <i>Building</i> Location, ⁽¹⁾ in Celsius Degree-Days					
	Zone 4: ⁽²⁾ < 3000	Zone 5: ⁽²⁾ 3000 to 3999	Zone 6: ⁽²⁾ 4000 to 4999	Zone 7A: ⁽²⁾ 5000 to 5999	Zone 7B: ⁽²⁾ 6000 to 6999	Zone 8: ⁽²⁾ ≥ 7000
	Maximum <i>Overall Thermal Transmittance</i> , W/(m ² ×K)					
All doors	2.12	1.90	1.90	1.90	1.90	1.44

Notes to Table 3.2.2.4.:

(1) See Sentence 1.1.4.1.(1).

(2) See Note A-Table 3.2.2.2.

3.2.3. Building Assemblies in Contact with the Ground

3.2.3.1. Thermal Characteristics of Walls in Contact with the Ground

1) Except as provided in Sentences (2) and (4), the *overall thermal transmittance* of walls or portions thereof that are below the exterior ground level and are part of the

building envelope shall be not greater than that shown in Table 3.2.3.1. for the applicable heating-degree-day category taken at 18°C.

2) Except as provided in Sentence (4), the *overall thermal transmittance* of walls or portions thereof that are below the exterior ground level and are part of the *building envelope* of semi-heated *buildings*, as defined in Sentence 1.2.1.2.(2), shall be not greater than that shown in Table 3.2.3.1. for the applicable heating-degree-day category taken at 15°C.

Table 3.2.3.1.
Overall Thermal Transmittance of Building Assemblies in Contact with the Ground
 Forming Part of Sentences 3.2.2.2.(3), 3.2.3.1.(1) and (2), 3.2.3.2.(1) and (2), and 3.2.3.3.(1) to (4)

Assembly in Contact with the Ground	Heating Degree-Days of <i>Building Location</i> , ⁽¹⁾ in Celsius Degree-Days					
	Zone 4: ⁽²⁾ < 3000	Zone 5: ⁽²⁾ 3000 to 3999	Zone 6: ⁽²⁾ 4000 to 4999	Zone 7A: ⁽²⁾ 5000 to 5999	Zone 7B: ⁽²⁾ 6000 to 6999	Zone 8: ⁽²⁾ ≥ 7000
	Maximum <i>Overall Thermal Transmittance</i> , W/(m ² ·K)					
Walls	0.568	0.379	0.284	0.284	0.284	0.210
Roofs	0.568	0.379	0.284	0.284	0.284	0.210
Floors	0.757 for 1.2 m	0.757 for 1.2 m	0.757 for 1.2 m	0.757 for 1.2 m	0.757 for 1.2 m	0.379 for full area

Notes to Table 3.2.3.1.:

- (1) See Sentence 1.1.4.1.(1).
- (2) See Note A-Table 3.2.2.2.

3) Insulation on walls or portions thereof that are in contact with the ground shall extend 2.4 m down from ground level or to the bottom of the wall, whichever is less. (See Note A-3.2.3.1.(3).)

4) Where radiant heating cables or heating or cooling pipes or membranes are embedded in the surface of a wall or portion thereof that is below the exterior ground level and that separates *conditioned space* from the ground, the wall shall have an *overall thermal transmittance* no greater than 80% of that required by Sentence (1). (See Note A-3.2.2.2.(4).)

5) Where the top of the footing is less than 0.6 m below the exterior ground level, the same level of insulation stated in Sentence (1) shall be placed on the top or bottom surface of the floor for a distance not less than 1.2 m from the perimeter.

3.2.3.2. Thermal Characteristics of Roofs in Contact with the Ground

1) Except as provided in Sentence (2), the *overall thermal transmittance* of below-ground roofs that are part of the *building envelope* and are less than 1.2 m below the exterior ground level shall be not greater than that shown in Table 3.2.3.1. for the applicable heating-degree-day category taken at 18°C. (See Note A-3.2.3.2.(1).)

2) The *overall thermal transmittance* of below-ground roofs that are less than 1.2 m below the exterior ground level and are part of the *building envelope* of semi-heated *buildings*, as defined in Sentence 1.2.1.2.(2), shall be not greater than that shown in Table 3.2.3.1. for the applicable heating-degree-day category taken at 15°C.

3.2.3.3. Thermal Characteristics of Floors in Contact with the Ground

(See Note A-3.2.3.3.)

1) Except as provided in Sentences (2) and (4), the *overall thermal transmittance* of floors separating *conditioned space* from the ground that are less than 0.6 m below *grade* shall be not greater than that shown in Table 3.2.3.1. for the applicable heating-degree-day category taken at 18°C.

2) Except as provided in Sentence (4), the *overall thermal transmittance* of floors separating *conditioned space* from the ground that are less than 0.6 m below *grade* in

3.2.4.1.

semi-heated *buildings*, as defined in Sentence 1.2.1.2.(2), shall be not greater than that shown in Table 3.2.3.1. for the applicable heating-degree-day category taken at 15°C.

3) Floors-on-ground with no embedded heating ducts, cables or heating or cooling pipes that are required to be insulated shall have insulation placed on their top or bottom surface for a distance of not less than 1.2 m from their perimeter or over their full area as shown in Table 3.2.3.1. for the applicable heating-degree-day category.

4) Floors-on-ground with embedded heating ducts or cables or heating and cooling pipes shall

- a) have an *overall thermal transmittance* that is no greater than that shown in Table 3.2.3.1. for the applicable heating-degree-day category, and
- b) be insulated under their full area.

5) Except where the wall insulation is placed on the outside of the *foundation* wall and extends down to the level of the bottom of the floor, the insulation for floors-on-ground that are required to be insulated shall extend vertically around the perimeter of the floor.

3.2.4. Air Leakage**3.2.4.1. General**

1) To control air leakage into and out of the *conditioned space*, the *building envelope* shall be designed and constructed with a continuous air barrier system comprised of *air barrier assemblies* by complying with

- a) Article 3.2.4.2., or
- b) Article 3.2.4.3.

3.2.4.2. Air Barrier System

1) The air barrier system shall have a normalized air leakage rate not greater than 1.50 L/(s×m²) when tested in accordance with ASTM E3158, "Standard Test Method for Measuring the Air Leakage Rate of a Large or Multizone Building," at a pressure differential of 75 Pa, using the following criteria:

- a) the *building* shall be prepared in accordance with the *building envelope* test described in the standard,
- b) the air leakage test shall be conducted under both pressurized and depressurized conditions, and
- c) the air leakage area used to determine the normalized air leakage rate shall include all the surfaces separating *conditioned space* from unconditioned space.

(See Note A-3.2.4.2.(1).)

2) The air leakage rates measured in accordance with Sentence (1) shall be averaged.

3.2.4.3. Air Barrier Assemblies

1) *Air barrier assemblies* shall have an air leakage rate not greater than 0.2 L/(s×m²) at a pressure differential of 75 Pa. (See Note A-3.2.4.3.(1) and (2).)

2) *Air barrier assemblies*

- a) shall conform to CAN/ULC-S742, "Standard for Air Barrier Assemblies – Specification," or
- b) shall
 - i) be designed, evaluated and constructed to provide the principal resistance to air leakage,
 - ii) be designed using the 1-in-50 hourly wind pressure for the *building* location, and
 - iii) have at least one air barrier material intended to provide the principal resistance to air leakage that conforms to CAN/ULC-S741, "Standard for Air Barrier Materials – Specification."

(See Note A-3.2.4.3.(1) and (2).)

3) Metal and glass curtain walls that act as environmental separators shall have an air leakage rate not greater than $0.2 \text{ L}/(\text{s}\times\text{m}^2)$ when a specimen prepared in accordance with AAMA 501.5, "Test Method for Thermal Cycling of Exterior Walls," is tested in accordance with ASTM E283/E283M, "Standard Test Method for Determining Rate of Air Leakage Through Exterior Windows, Skylights, Curtain Walls, and Doors Under Specified Pressure Differences Across the Specimen," at a pressure differential of 75 Pa.

4) Fixed windows and *skylights* that act as environmental separators shall have an air leakage rate not greater than $0.2 \text{ L}/(\text{s}\times\text{m}^2)$ when tested in accordance with AAMA/WDMA/CSA 101/I.S.2/A440, "North American Fenestration Standard/Specification for windows, doors, and skylights," at a pressure differential of 75 Pa.

5) Operable windows and *skylights* that act as environmental separators shall have an air leakage rate not greater than $0.5 \text{ L}/(\text{s}\times\text{m}^2)$ when tested in accordance with AAMA/WDMA/CSA 101/I.S.2/A440, "North American Fenestration Standard/Specification for windows, doors, and skylights," at a pressure differential of 75 Pa.

6) Except as provided in Sentences (7) to (9), doors that act as environmental separators shall have an air leakage rate not greater than $0.5 \text{ L}/(\text{s}\times\text{m}^2)$ when tested in accordance with ASTM E283/E283M, "Standard Test Method for Determining Rate of Air Leakage Through Exterior Windows, Skylights, Curtain Walls, and Doors Under Specified Pressure Differences Across the Specimen," at a pressure differential of 75 Pa.

7) Revolving doors and automatic commercial sliding doors, including their respective fixed sections, that act as environmental separators are permitted to have an air leakage rate not greater than $5.0 \text{ L}/(\text{s}\times\text{m}^2)$ when tested as a complete assembly in accordance with ASTM E283/E283M, "Standard Test Method for Determining Rate of Air Leakage Through Exterior Windows, Skylights, Curtain Walls, and Doors Under Specified Pressure Differences Across the Specimen," at a pressure differential of 75 Pa.

8) Overhead doors that act as environmental separators are permitted to have an air leakage rate not greater than $2.0 \text{ L}/(\text{s}\times\text{m}^2)$ when tested as a complete assembly at a pressure differential of 75 Pa in accordance with

- a) ANSI/DASMA 105, "Test Method for Thermal Transmittance and Air Infiltration of Garage Doors," or
- b) ASTM E283/E283M, "Standard Test Method for Determining Rate of Air Leakage Through Exterior Windows, Skylights, Curtain Walls, and Doors Under Specified Pressure Differences Across the Specimen."

9) Main entry exterior doors that act as environmental separators are permitted to have an air leakage rate not greater than $5.0 \text{ L}/(\text{s}\times\text{m}^2)$ when tested as a complete assembly in accordance with ASTM E283/E283M, "Standard Test Method for Determining Rate of Air Leakage Through Exterior Windows, Skylights, Curtain Walls, and Doors Under Specified Pressure Differences Across the Specimen," at a pressure differential of 75 Pa, provided that the total area of such doors does not exceed 2% of the gross wall area calculated in accordance with Article 3.1.1.6.

10) Loading docks that interface with truck boxes shall have weather seals that seal the truck box to the *building*.

11) Fireplaces shall be equipped with doors, enclosures or devices to restrict air movement through the chimney when the fireplace is not in use.

Section 3.3. Trade-off Path

(See Note A-1.1.2.1.)

3.3.1. Simple Trade-off Path

3.3.1.1. Application and Limitations

1) Subject to the limitations stated in this Article, the simple trade-off path applies only to variations from the maximum *overall thermal transmittance* of above-ground

assemblies and to the allowable *fenestration* and door areas prescribed in Section 3.2., provided it can be demonstrated using the equation in Article 3.3.1.2. that the *building envelope* will not transfer more energy than it would if all its components complied with that Section.

- 2) This Subsection does not apply to *additions* or to semi-heated *buildings*, as defined in Sentence 1.2.1.2.(2).
- 3) Vertical above-ground portions of the *building envelope* are only permitted to be traded off against other vertical above-ground portions of the *building envelope*.
- 4) Horizontal above-ground portions of the *building envelope* are only permitted to be traded off against other horizontal above-ground portions of the *building envelope*.
- 5) The *overall thermal transmittance* of *building envelope* assemblies that have radiant heating cables or heating or cooling pipes or membranes embedded in them shall not be increased to more than the *overall thermal transmittance* permitted by Sentence 3.2.2.2.(4).
- 6) Where the construction techniques used result in increased performance compared to those required to be used by Articles 3.2.1.1. and 3.2.2.1. and Subsection 3.2.4., that difference in performance levels shall not be used in trade-off calculations. (See Note A-3.3.1.1.(6).)
- 7) Where the *building envelope* components used are more energy-efficient than those prescribed in Section 3.2., the trade-off calculation is permitted to take this increased performance level into account, provided it can be quantified and is not dependent on occupant interaction.

3.3.1.2. Simple Trade-off Calculations

- 1) For the purpose of simple trade-off calculations, the sum of the areas of all above-ground assemblies in the proposed *building* shall be equal to the sum of the areas of the corresponding above-ground assemblies in the reference *building*.
- 2) Compliance with Article 3.3.1.1. shall be determined using the equation that follows to demonstrate that the sum of the areas of all above-ground assemblies of the *building envelope* multiplied by their respective *overall thermal transmittance* is not more than it would be if all assemblies complied with Section 3.2.:

$$\sum_{i=1}^n U_{ip} A_{ip} \leq \sum_{i=1}^n U_{ir} A_{ir}$$

where

- n = total number of above-ground assemblies,
- U_{ip} = *overall thermal transmittance* of assembly i of the proposed *building*,
- A_{ip} = area of assembly i of the proposed *building*,
- U_{ir} = *overall thermal transmittance* of assembly i of the reference *building*, and
- A_{ir} = area of assembly i of the reference *building*.

Section 3.4. Performance Path

(See Note A-1.1.2.1.)

3.4.1. General

3.4.1.1. Scope

- 1) Subject to the limitations stated in Article 3.4.1.2., where the *building envelope* does not comply with the requirements of Section 3.2. or 3.3., it shall comply with Part 8.

3.4.1.2. Limitations

1) Notwithstanding application of the performance path provisions, Article 3.2.1.1. and Subsection 3.2.4. shall apply.

Section 3.5. Objective and Functional Statements

3.5.1. Objective and Functional Statements

3.5.1.1. Attributions to Acceptable Solutions

1) For the purpose of compliance with this Code as required in Clause 1.2.1.1.(1)(b) of Division A, the objective and functional statements attributed to the acceptable solutions in this Part shall be the objective and functional statements listed in Table 3.5.1.1. (See Note A-1.1.3.1.(1).)

Table 3.5.1.1.
Objectives and Functional Statements Attributed to the
Acceptable Solutions in Part 3
Forming Part of Sentence 3.5.1.1.(1)

Provision	Functional Statements and Objectives ⁽¹⁾
3.1.1.5. Thermal Characteristics of Building Assemblies	
(1)	[F92-OE1.1]
(2)	[F92-OE1.1]
(3)	[F92-OE1.1]
(4)	[F92-OE1.1]
(5)	[F92-OE1.1]
3.1.1.7. Calculation of Overall Thermal Transmittance	
(1)	[F92-OE1.1]
(5)	[F92-OE1.1]
(6)	[F92-OE1.1]
(7)	[F92-OE1.1]
(8)	[F92-OE1.1]
3.2.1.1. Protection of Insulation Materials	
(1)	[F92-OE1.1]
(2)	[F92-OE1.1]
3.2.1.2. Continuity of Insulation	
(1)	[F92-OE1.1]
(2)	[F92-OE1.1]
3.2.1.3. Spaces Heated to Different Temperatures	
(1)	[F92-OE1.1]
3.2.1.4. Allowable Fenestration and Door Area	
(1)	[F92,F99-OE1.1]
(2)	[F92,F99-OE1.1]
3.2.2.1. Vestibules	
(1)	[F90-OE1.1]
(2)	[F90-OE1.1]

Table 3.5.1.1. (Continued)

Provision	Functional Statements and Objectives ⁽¹⁾
3.2.2.2. Thermal Characteristics of Above-ground Opaque Building Assemblies	
(1)	[F92-OE1.1]
(2)	[F92-OE1.1]
(3)	[F92-OE1.1]
(4)	[F92,F95-OE1.1]
3.2.2.3. Thermal Characteristics of Fenestration	
(2)	[F92-OE1.1]
(3)	[F92-OE1.1]
3.2.2.4. Thermal Characteristics of Doors and Access Hatches	
(1)	[F92-OE1.1]
(2)	[F92-OE1.1]
(3)	[F92-OE1.1]
(4)	[F92-OE1.1]
3.2.3.1. Thermal Characteristics of Walls in Contact with the Ground	
(1)	[F92-OE1.1]
(2)	[F92-OE1.1]
(3)	[F92-OE1.1]
(4)	[F92,F95-OE1.1]
(5)	[F92-OE1.1]
3.2.3.2. Thermal Characteristics of Roofs in Contact with the Ground	
(1)	[F92-OE1.1]
(2)	[F92-OE1.1]
3.2.3.3. Thermal Characteristics of Floors in Contact with the Ground	
(1)	[F92-OE1.1]
(2)	[F92-OE1.1]
(3)	[F92-OE1.1]
(4)	[F92,F95-OE1.1]
(5)	[F92-OE1.1]

Table 3.5.1.1. (Continued)

Provision	Functional Statements and Objectives ⁽¹⁾
3.2.4.1. General	
(1)	[F90-OE1.1]
3.2.4.2. Air Barrier System	
(1)	[F90-OE1.1]
(2)	[F90-OE1.1]
3.2.4.3. Air Barrier Assemblies	
(1)	[F90-OE1.1]
(2)	[F90-OE1.1]
(3)	[F90-OE1.1]
(4)	[F90-OE1.1]
(5)	[F90-OE1.1]
(6)	[F90-OE1.1]
(8)	[F90-OE1.1]
(10)	[F90-OE1.1]
(11)	[F90-OE1.1]
3.3.1.1. Application and Limitations	
(2)	[F92-OE1.1]
(3)	[F92-OE1.1]
(4)	[F92-OE1.1]
(5)	[F92,F95-OE1.1]
(6)	[F90,F91,F92-OE1.1]
3.3.1.2. Simple Trade-off Calculations	
(1)	[F92-OE1.1]
(2)	[F92-OE1.1]
3.4.1.2. Limitations	
(1)	[F90,F92-OE1.1]

Notes to Table 3.5.1.1.:

(1) See Parts 2 and 3 of Division A.

Division B

Notes to Part 3 Building Envelope

A-3.1.1.2.(1)(a) Space-conditioning Systems. A cooking stove, pot heater or window air conditioner should not be considered a system in the context of Clause 3.1.1.2.(1)(a), but electric baseboard heaters, for example, in the principal rooms should.

A-3.1.1.3.(1) Compliance. The flow chart in Figure A-3.1.1.3.(1) illustrates the process for all three paths of compliance applicable to Part 3.

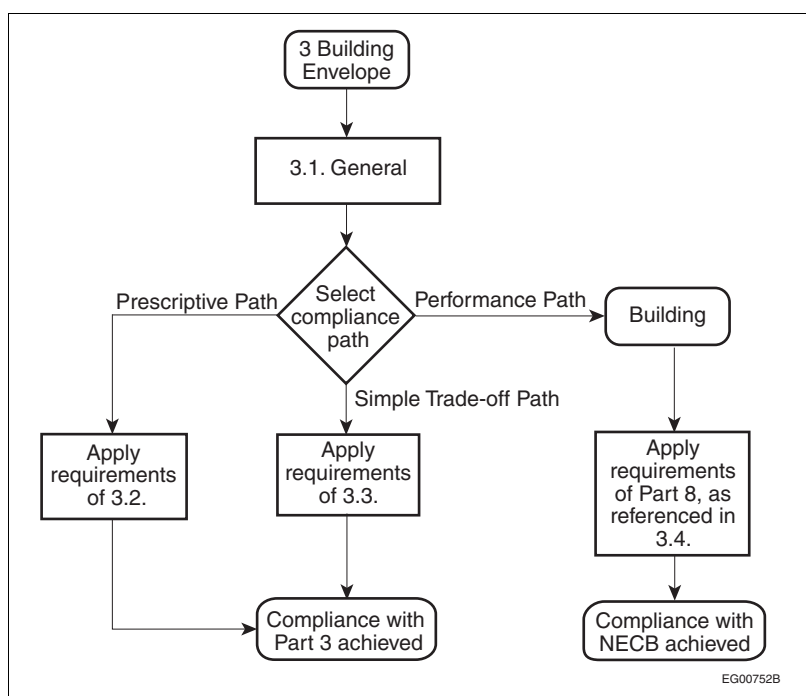

Figure A-3.1.1.3.(1)
Code compliance paths for the building envelope

A-3.1.1.3.(1)(c) Performance Path. The building energy performance compliance path is a whole-building approach; therefore if this path is chosen to achieve compliance, it must be the only path applied to all building parameters.

A-3.1.1.5. Thermal Characteristics of Building Assemblies. Thermal characteristics of building assemblies can also be determined through the use of computer simulation models.

These Notes are included for explanatory purposes only and do not form part of the requirements. The number that introduces each Note corresponds to the applicable requirement in this Part.

A-3.1.1.5.(5)(a) Thermal Bridging Calculations. Acceptable sources of information for calculating the effect of thermal bridging are the “Building Envelope Thermal Bridging Guide,” which is available through BC Hydro or the Licensing and Consumer Services branch of BC Housing, and ASHRAE Research Project Report RP-1365, “Thermal Performance of Building Envelope Details for Mid- and High-Rise Buildings.”

A-3.1.1.6.(1) Fenestration and Door Areas. The method of calculation of fenestration and door areas is slightly different in Sentence 3.1.1.6.(1) from the one used in CSA A440.2/A440.3, “Fenestration energy performance/User guide to CSA A440.2:19, Fenestration energy performance,” for windows and doors. For calculating the fenestration area of a building, this Code uses the dimensions of rough openings to facilitate determination of compliance.

Figure A-3.1.1.6.(1) illustrates the requirements of Sentence 3.1.1.6.(1).

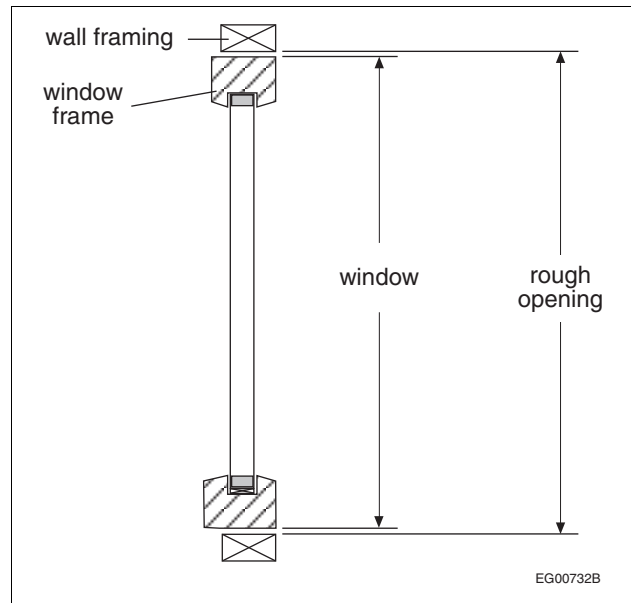

Figure A-3.1.1.6.(1)
Measuring fenestration and door areas

A-3.1.1.6.(2) Areas of Other Fenestration. Figure A-3.1.1.6.(2) illustrates how to measure the area of glass panes as described in Sentence 3.1.1.6.(2).

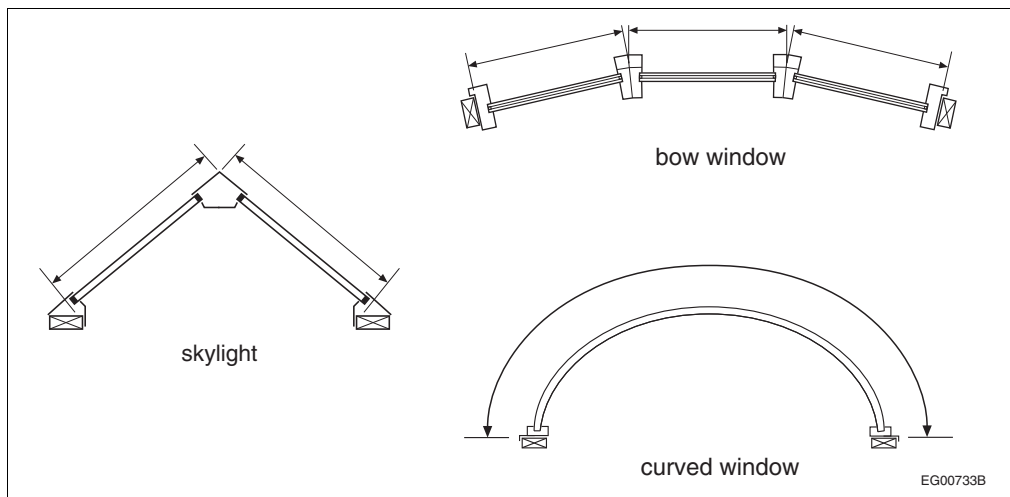

Figure A-3.1.1.6.(2)
Measuring areas of glazing that is not in the same plane

A-3.1.1.7.(1)(b) Major Structural Elements. Examples of major structural elements that could penetrate the building envelope are walls, floors, roofs, balconies, joists, beams, girders, columns, and curbs.

A-3.1.1.7.(1)(d) Secondary Structural Members. Secondary structural members typically attach cladding elements to primary structural members. Examples of secondary structural members are girts, purlins, sub-girts, hat-channels, U-channels, and shelf angles.

A-3.1.1.7.(2) Penetrations through the Building Envelope. The impact of penetrations described in Sentence 3.1.1.7.(2) on the overall thermal transmittance is difficult to assess but is considered to be negligible if the insulation is installed tight to the penetration.

A-3.1.1.7.(4) Effect of an Unconditioned Space. The conservative overall thermal transmittance allowed in Sentence 3.1.1.7.(4), which is equivalent to that of a layer of glass, is intended to provide an easy credit under the prescriptive path for any unconditioned space that may be protecting a component of the building envelope.

The value given does not take into account the construction of the enclosure surrounding the unconditioned space; the construction of this enclosure being uncontrolled by this Code, too many variables, such as its size or airtightness, may negate any higher credit that could be allowed. There may be simulation tools under the performance path that can provide a better assessment of the effect of an indirectly heated space, which may be used to advantage when an unheated space is designed to provide significantly better protection than the worst-case scenario assumed here. Vented spaces, such as attic and roof spaces or crawl spaces, are considered to be part of the exterior space; therefore, Sentence 3.1.1.7.(4) does not apply when calculating the overall thermal transmittance of their building envelope components.

A-3.2.1.1.(1) Protection of Insulation Materials. Sentence 3.2.1.1.(1) is not intended to preclude the use of building envelope systems such as protected membrane roofing systems, vegetative roofing systems, EIFS in rainscreen applications, and exterior insulation on below-grade walls.

A-3.2.1.2.(2) Continuity of Insulation Where Components Meet. Sentence 3.2.1.2.(2) calls for continuity of the insulation at the intersection of two components of the building envelope, such as a wall with another wall or a roof, or a wall with a window. This means that there should be no gap in the insulation between the two components. An obvious application is insulating the space between a window or door frame and the rough framing members.

A-3.2.1.3.(1) Spaces Heated to Different Temperatures. This requirement applies, for example, to walls or floors that separate spaces, one of which is heated to a normal comfort temperature and the other of which is heated to a significantly lower temperature and kept floating above that point. This would be the case of a wall between an office block and an attached warehouse that is heated just to keep it above freezing.

A-3.2.1.4.(1) Total Vertical Fenestration and Door Area to Gross Wall Area. Table A-3.2.1.4.(1) shows a sample of maximum allowable FDWR for various HDD.

Table A-3.2.1.4.(1)
Maximum Allowable FDWR for Various HDD

HDD	Maximum FDWR
< 4000	0.40
4000	0.40
4250	0.38
4500	0.37
4750	0.35
5000	0.33
5250	0.32
5500	0.30
5750	0.28
6000	0.27

Table A-3.2.1.4.(1) (Continued)

HDD	Maximum FDWR
6250	0.25
6500	0.23
6750	0.22
7000	0.20
> 7000	0.20

A-3.2.2.2.(1) Thermal Characteristics of Components of the Building Envelope. The overall thermal transmittance of a building assembly is the area-weighted average thermal transmittance, or U-value, of the overall assembly, including insulation, sheathing, interior and exterior finish materials and air films, and taking into account thermal bridging due to framing members, in accordance with the calculation procedures of Article 3.1.1.7. The U-value for above-ground walls also applies to the perimeter areas of intersecting interior walls and to the above-ground portion of foundation walls, except as provided in Sentence 3.2.2.2.(3).

A-Table 3.2.2.2. Climate Zones. The thermal criteria and climate zones referred to in this Code are based on ANSI/ASHRAE/IES 90.1, “Energy Standard for Buildings Except Low-Rise Residential Buildings,” however, the thermal criteria have been revised

- to eliminate the moist (A), dry (B) and marine (C) definitions, and
- to separate climate zone 7 into 7A (5000 to 5999 HDD) and 7B (6000 to 6999 HDD).

A-3.2.2.2.(4) Thermal Characteristics of Components with Embedded Radiant Heating or Cooling. Sentence 3.2.2.2.(4) applies to insulated walls and top-storey ceilings under a roof or unheated attic space that have radiant heating or cooling equipment embedded in them. The maximum overall thermal transmittance of a wall or ceiling containing radiant heating cables or heating or cooling pipes or membranes is decreased in order to counteract the increased heat loss that occurs due to the increased temperature difference between the interior and exterior surfaces. Below-ground walls incorporating radiant heating or cooling equipment are covered in Sentence 3.2.3.1.(4); slabs-on-ground incorporating radiant heating or cooling equipment are covered in Sentence 3.2.3.3.(4).

A-3.2.2.4.(5) Application to Sliding Glass Doors and Revolving Doors. Notwithstanding the exemption in Sentence 3.2.2.4.(5) regarding the thermal requirements of the types of doors listed, the glazed areas of automatic sliding doors and revolving doors must be factored in as part of the area of fenestration, as required by Article 3.1.1.6.

A-3.2.3.1.(3) Walls in Contact with the Ground. The term “ground level” as used in Sentence 3.2.3.1.(3) has a different meaning than “grade,” which is a defined term in the NBC and the NECB. The wording of Sentence 3.2.3.1.(3) requires that the bottom of the insulation follow the contours of the exterior ground level at the required depth.

A-3.2.3.2.(1) Roofs in Contact with the Ground. Sentence 3.2.3.2.(1) refers to structures that are normally below grade such as walkways or storage garages. It does not refer to structures with vegetative roofs as might be built at elevations above grade.

A-3.2.3.3. Floors in Contact with the Ground. Article 3.2.3.3. is intended to include floors of crawl spaces even when there is no actual constructed floor.

The minimum depth at which insulation is required is measured once for the entire floor from the level of grade (see Note A-3.2.3.1.(3)), i.e., even if the exterior soil level (ground) varies, the whole floor (or perimeter) either has to be insulated or doesn't; this doesn't require some parts of the floor (or perimeter) to be insulated and some parts not. Consideration should be given to insulating the entire floor at sites where the soil is highly conductive or where there is a permanently high water table. The diagrams in Figure A-3.2.3.3. illustrate the insulation requirements for various types of floors-on-ground, where these are less than 0.6 m below grade.

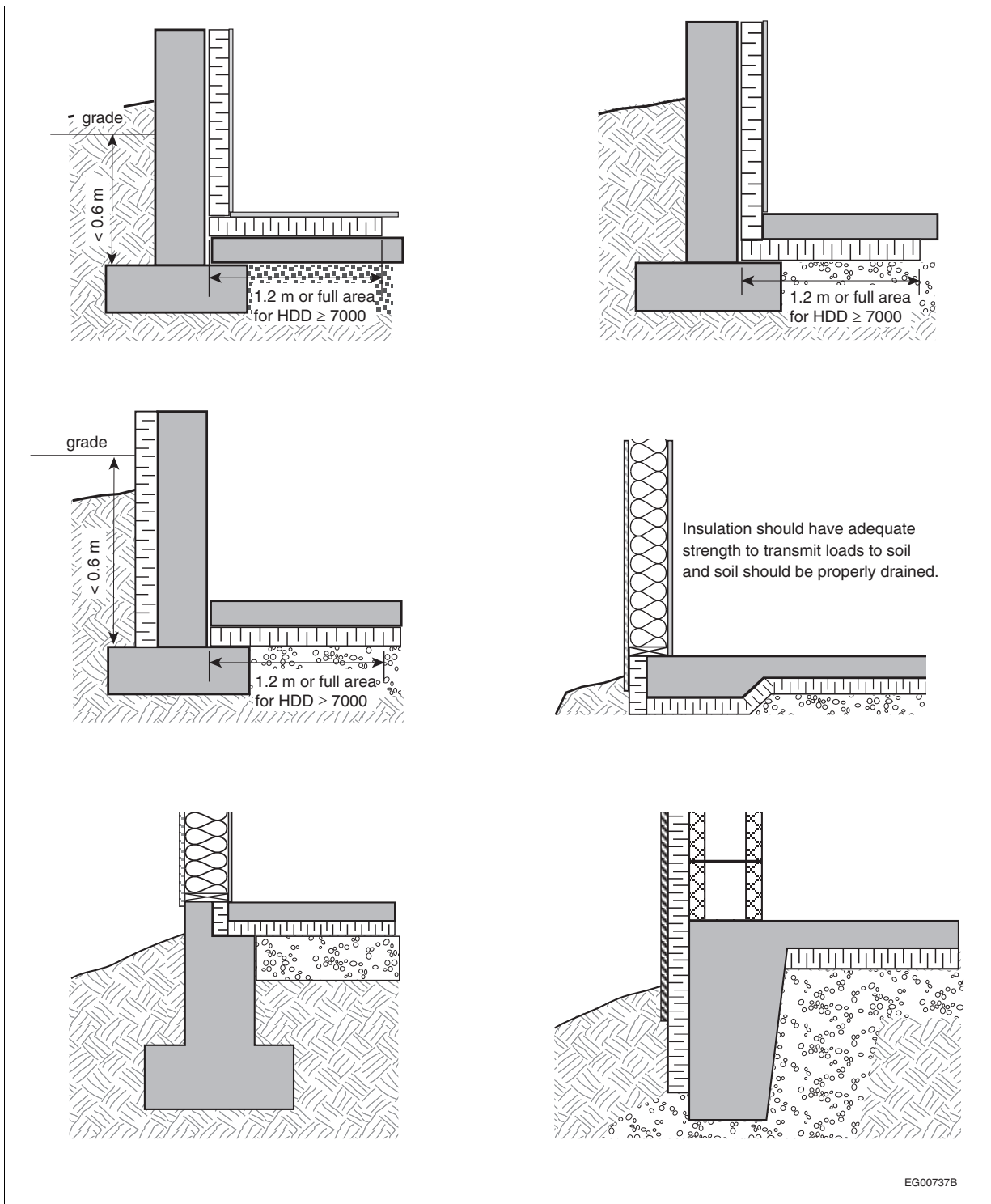

Figure A-3.2.3.3.
Insulation of floors in contact with the ground

Note to Figure A-3.2.3.3.:

(1) Grade does not necessarily coincide with the ground levels shown in the diagrams.

A-3.2.4.2.(1) Air Leakage Testing. Only the building envelope undergoes air leakage testing; air leakage through HVAC grilles, louvres and dampers is not included. These HVAC components are sealed off so that only the air barrier connection to them is included in the air leakage rate of the building.

A-3.2.4.3.(1) and (2) Air Barrier Assembly Testing. Air barrier assemblies are subject to structural loading due to mechanical systems, wind pressure and stack effect. In addition, they may be affected by physical degradation resulting from thermal or structural movement. CAN/ULC-S742, “Standard for Air Barrier Assemblies – Specification,” outlines testing limits. Where local climatic data and building conditions exceed these limits, the maximum building height and sustained 1-in-50 hourly wind pressure values covered in CAN/ULC-S742 can be extrapolated beyond the listed ranges to apply to any building height in any location, provided the air barrier assembly in question has been tested to the specific building site and design parameters.

A-3.3.1.1.(6) Limits to Trade-offs. There are several reasons why the listed prescriptive provisions are not subject to trade-off calculations. In some cases, the energy-conserving impact of provisions cannot be easily quantified and allowing trade-offs would be unenforceable: this is the case, for instance, for building envelope air leakage requirements (Subsection 3.2.4.). Other prescriptive provisions simply do not lend themselves to trade-offs.

Division B

Part 4 Lighting

4.1.	General	
4.1.1.	General	4-1
4.2.	Prescriptive Path	
4.2.1.	Interior Lighting Power	4-1
4.2.2.	Interior Lighting Controls	4-12
4.2.3.	Exterior Lighting Power	4-16
4.2.4.	Exterior Lighting Controls	4-19
4.3.	Trade-off Path	
4.3.1.	General	4-19
4.3.2.	Installed Interior Lighting Energy	4-20
4.3.3.	Interior Lighting Energy Allowance	4-32
4.4.	Performance Path	
4.4.1.	General	4-34
4.5.	Objective and Functional Statements	
4.5.1.	Objective and Functional Statements	4-34
	Notes to Part 4	4-37

Division B

Part 4 Lighting

Section 4.1. General

4.1.1. General

4.1.1.1. Scope

1) This Part is concerned with lighting components and systems for the applications listed in Article 4.1.1.2.

4.1.1.2. Application

1) Except as provided in Sentence (2), this Part applies to lighting components and systems that are connected to the *building's* electrical service. (See Note A-4.1.1.2.(1).)

2) This Part does not apply to the following lighting systems:

- a) emergency lighting that is automatically off during normal hours of *building* operation,
- b) lighting within *dwelling units*, and
- c) lighting in *buildings* or parts of *buildings* and in certain exterior spaces associated with the *building* where it can be shown that the nature of the *occupancy* makes it impractical to apply these requirements (see Note A-4.1.1.2.(2)(c)).

4.1.1.3. Compliance

1) Compliance with this Part shall be achieved by following

- a) the prescriptive path described in Section 4.2.,
- b) the trade-off path described in Section 4.3., or
- c) the performance path described in Section 4.4. (see Note A-3.1.1.3.(1)(c)).

(See Note A-4.1.1.3.(1).)

4.1.1.4. Definitions

1) Words that appear in italics are defined in Article 1.4.1.2. of Division A.

Section 4.2. Prescriptive Path

4.2.1. Interior Lighting Power

4.2.1.1. Exit Signs

1) Power requirements for lighting units for internally illuminated *exit* signs shall conform to CAN/CSA-C860, "Performance of internally lighted exit signs."

4.2.1.2. Fluorescent Lamp Ballasts

1) Fluorescent lamp ballasts shall conform to CAN/CSA-C654, "Fluorescent lamp ballast efficacy measurements."

4.2.1.3.

2) Electronic fluorescent lamp ballasts that are not within the scope of CAN/CSA-C654, "Fluorescent lamp ballast efficacy measurements," shall conform to ANSI/ANSI C82.11, "American National Standard for Lamp Ballasts—High-Frequency Fluorescent Lamp Ballasts."

4.2.1.3. Limits to Installed Interior Lighting Power

(See Note A-4.2.1.3.)

- 1)** The *installed interior lighting power* described in Article 4.2.1.4. shall not exceed the value of the *interior lighting power allowance* determined using
 - a) the *building area method* described in Article 4.2.1.5., or
 - b) the *space-by-space method* described in Article 4.2.1.6.
- 2)** The individual power allowances in each space of the *building* do not have to be met, provided the total *installed interior lighting power* is not exceeded.
- 3)** Only one of the methods described in Sentence (1) shall be selected for use within the same *building*.

4.2.1.4. Determination of the Installed Interior Lighting Power

- 1)** Except as provided in Sentences (4) and (5), the *installed interior lighting power* shall include all power used by the luminaires, including lamps, ballasts, transformers, and control devices.
- 2)** The determination of the *installed interior lighting power* shall include
 - a) connected lighting power for both permanently installed *interior lighting* and supplemental *interior lighting* provided by movable or plug-in luminaires, and
 - b) in cases where two or more independently operating lighting systems in a space are controlled to prevent simultaneous operation, the lighting system with the highest wattage.

(See Note A-4.2.1.4.(2).)

- 3)** Luminaire wattage to be included in *installed interior lighting power* shall be determined in accordance with the following criteria:
 - a) except as provided in Clause (b), the wattage of luminaires shall be the design operating input wattage of the lamp/auxiliary combination based on values provided by a recognized testing laboratory or, in the absence of such information, the maximum labeled wattage of the luminaire shall be used (see Note A-4.2.1.4.(3)(a)),
 - b) the wattage of luminaires with ballasts designed for multiple wattages shall be the maximum labeled wattage of the luminaire,
 - c) for line-voltage lighting track and plug-in busway designed to allow the addition and/or relocation of luminaires without altering the wiring of the system, the wattage shall be
 - i) the specified wattage of the luminaires included in the system with a minimum of 98 W/m,
 - ii) the wattage limit of the system's circuit breaker, or
 - iii) the wattage limit of other permanent current-limiting device(s) on the system,
 - d) the wattage of low-voltage lighting track, cable conductor, rail conductor, and other flexible lighting systems that allow the addition and/or relocation of luminaires without altering the wiring of the system shall be the specified wattage of the transformer supplying the system, and
 - e) the wattage of all other miscellaneous lighting equipment shall be the specified wattage of the lighting equipment.
- 4)** Lighting for the following functions, spaces or equipment need not be included in the calculation of *installed interior lighting power*:
 - a) display or accent lighting that is an essential element for the function it performs in galleries, museums, and monuments,
 - b) lighting that is integral to equipment or instrumentation and is installed by its manufacturer,

- c) lighting specifically designed for use only during medical or dental procedures,
- d) lighting integral to both open and glass-enclosed refrigerator and freezer cases,
- e) lighting integral to food warming and food preparation equipment,
- f) lighting for plant growth or maintenance,
- g) lighting in retail display windows, provided the display area is enclosed by ceiling-height *partitions*,
- h) lighting in interior spaces that have been specifically designated as a registered interior historic landmark,
- i) lighting that is an integral part of advertising or directional signage,
- j) *exit* signs,
- k) lighting that is for sale or for lighting educational demonstration systems,
- l) lighting for theatrical purposes, including performance, stage, and film and video production,
- m) lighting for television broadcasting in sporting activity areas,
- n) casino gaming areas,
- o) mirror lighting in dressing rooms, and
- p) accent lighting in religious pulpit and choir areas.

5) Lighting for functions, spaces or equipment need not be included in the calculation of *installed interior lighting power* where it can be shown that its inclusion will adversely affect the intended functions or the use of the space or equipment.

4.2.1.5. Calculation of Interior Lighting Power Allowance Using the Building Area Method

(See Note A-4.2.1.5.)

1) Calculation of *interior lighting power allowance* using the *building* area method as provided in this Article may be applied only where

- a) the *interior lighting power allowance* is being determined for an entire *building*, and
- b) the *building* type or an equivalent *building* type is identified in Table 4.2.1.5.

2) Except as provided in Sentence (3), *interior lighting power allowance* calculations shall be based on the primary use for which the *building* is intended.

3) Where 10% or more of the *gross lighted area* of the *building* can be classified as being of a *building* type other than the principal type for the *building*, the *interior lighting power allowance* shall be calculated using the space-by-space method described in Article 4.2.1.6.

4) Where the *building* is of a type other than those listed in Table 4.2.1.5. and no equivalent *building* type can be selected, the *interior lighting power allowance* shall be calculated using the space-by-space method described in Article 4.2.1.6.

5) The *interior lighting power allowance* using the *building* area method shall be calculated by multiplying the lighting power density, in W/m², for the *building* type provided in Table 4.2.1.5. by the *gross lighted area*, in m².

Table 4.2.1.5.
Lighting Power Density by Building Type for Use with the Building Area Method
 Forming Part of Sentences 4.2.1.5.(1), (4) and (5)

<i>Building Type</i>	Lighting Power Density, W/m ²
Automotive facility	8.1
Convention centre	6.9
Courthouse	8.5
Dining	
bar lounge/leisure	8.6
cafeteria/fast food	8.2

Table 4.2.1.5. (Continued)

Building Type	Lighting Power Density, W/m ²
family	7.6
Dormitory	5.7
Exercise centre	7.8
Fire station	6.0
Gymnasium	8.2
Healthcare clinic	8.7
Hospital	10.3
Hotel/Motel	6.0
Library	8.9
Manufacturing facility	8.8
Motion picture <i>theatre</i>	4.7
Multi-unit residential <i>building</i>	4.8
Museum	5.9
Office	6.9
Penitentiary	7.4
Performing arts <i>theatre</i>	9.0
Police station	7.1
Post office	7.0
Religious <i>building</i>	7.2
Retail area	9.0
School/university	7.8
Sports arena	8.2
<i>Storage garage</i>	1.9
Town hall	7.4
Transportation facility	5.4
Warehouse	4.8
Workshop	9.8

4.2.1.6. Calculation of Interior Lighting Power Allowance Using the Space-by-Space Method

1) The *interior lighting power allowance* using the space-by-space method shall be determined as follows:

- a) the gross interior floor area of each *enclosed space* shall be determined based on the inside dimensions of the space,
- b) the allowed lighting power density (LPD) for each *enclosed space* shall be determined using Table 4.2.1.6. for the exact space type or a space type that most closely represents the proposed use of each space,
- c) the lighting power allowance for each *enclosed space* shall be calculated by multiplying the floor area determined in Clause (a) by the allowed LPD determined in Clause (b), and
- d) the *interior lighting power allowance* for the entire *building* shall be calculated by summing the lighting power allowances of all *enclosed spaces* determined in Clause (c).

Table 4.2.1.6.
Lighting Power Density Using the Space-by-Space Method and Minimum Lighting Control Requirements
 Forming Part of Sentences 4.2.1.6.(1), 4.2.2.1.(2), (3), (6), (8), (9), (10), (13), (16), (18) and (20), 4.3.1.3.(5), 4.3.3.2.(1) and 8.4.4.5.(8)

Space Type	Lighting Power Density, W/m ²	Type of Lighting Control ⁽¹⁾								
		Manual [see 4.2.2.1.(3)]	Restricted to Manual ON [see 4.2.2.1.(6)]	Restricted to Partial Automatic ON ⁽²⁾ [see 4.2.2.1.(8)]	Bi-Level [see 4.2.2.1.(9)]	Automatic Daylight Responsive Controls for Sidelighting [see 4.2.2.1.(10)] ⁽³⁾	Automatic Daylight Responsive Controls for Toplighting [see 4.2.2.1.(13)] ⁽⁴⁾	Automatic Partial OFF [see 4.2.2.1.(16)]	Automatic Full OFF ⁽⁵⁾ [see 4.2.2.1.(18)]	Scheduled Shut-off [see 4.2.2.1.(20)]
Common Space Types⁽⁶⁾										
Atrium										
< 6 m in height	4.2	X	A	A	-	X	X	-	B	B
≥ 6 m and ≤ 12 m in height	5.2	X	A	A	X	X	-	B	B	B
> 12 m in height	6.5	X	A	A	X	X	-	B	B	B
Audience seating area – permanent										
for auditorium	6.5	X	A	A	X	X	-	B	B	B
for gymnasium	2.5	X	A	A	X	X	-	B	B	B
for motion picture theatre	2.9	X	A	A	X	X	-	B	B	B
for penitentiary	7.2	X	A	A	-	X	X	-	B	B
for performing arts theatre	12.5	X	A	A	X	X	-	B	B	B
for religious building	7.8	X	A	A	X	X	-	B	B	B
for sports arena	3.5	X	A	A	-	X	X	-	B	B
other	2.5	X	A	A	-	X	X	-	B	B
Banking activity area and offices	6.5	X	A	A	X	X	-	B	B	B
Classroom/Lecture hall/Training room										
for penitentiary	9.5	X	A	A	X	X	-	X	X	-
other	7.6	X	A	A	X	X	-	X	X	-
Computer/Server room	10.1	X	A	A	X	X	-	X	B	B
Conference/Meeting/Multi-purpose room	10.5	X	A	A	X	X	-	X	X	-

4.2.1.6.

Division B

Table 4.2.1.6. (Continued)

Space Type	Lighting Power Density, W/m ²	Type of Lighting Control ⁽¹⁾								
		Manual [see 4.2.2.1.(3)]	Restricted to Manual ON [see 4.2.2.1.(6)]	Restricted to Partial Automatic ON ⁽²⁾ [see 4.2.2.1.(8)]	Bi-Level [see 4.2.2.1.(9)]	Automatic Daylight Responsive Controls for Sidelighting [see 4.2.2.1.(10)] ⁽³⁾	Automatic Daylight Responsive Controls for Toplighting [see 4.2.2.1.(13)] ⁽⁴⁾	Automatic Partial OFF [see 4.2.2.1.(16)]	Automatic Full OFF ⁽⁵⁾ [see 4.2.2.1.(18)]	Scheduled Shut-off [see 4.2.2.1.(20)]
Confinement cell	7.5	X	A	A	X	X	X	-	B	B
Copy/Print room	3.3	X	A	A	X	X	X	-	X	-
Corridor/Transition area for hospital	7.7	X	-	-	-	X	X	B	B	B
for manufacturing facility	3.1	X	-	-	-	X	X	X	B	B
for space designed to ANSI/IES RP-28 (and used primarily by residents)	7.7	X	-	-	-	X	X	X	B	B
other	4.4	X	-	-	-	X	X	-	B	B
Courtroom	12.9	X	A	A	X	X	X	-	B	B
Dining area for bar lounge/leisure dining	9.3	X	A	A	X	X	X	-	B	B
for cafeteria/fast food dining	4.3	X	A	A	X	X	X	-	B	B
for family dining	6.5	X	A	A	X	X	X	-	B	B
for penitentiary	4.5	X	A	A	X	X	X	-	B	B
for space designed to ANSI/IES RP-28 (and used primarily by residents)	13.7	X	A	A	X	X	X	-	B	B
other	4.7	X	A	A	X	X	X	-	B	B
Dressing/Fitting room for performing arts theatre	4.4	X	A	A	X	X	X	-	X	-
Electrical/Mechanical room	4.6	X	-	-	-	X	X	-	-	-
Emergency vehicle garage	5.6	X	A	A	-	X	X	-	B	B
Food preparation area	11.7	X	A	A	X	X	X	-	B	B
Guest room	4.4									

See Sentence 4.2.2.6.(2)

Table 4.2.1.6. (Continued)

Space Type	Lighting Power Density, W/m ²	Type of Lighting Control ⁽¹⁾								
		Manual [see 4.2.2.1.(3)]	Restricted to Manual ON [see 4.2.2.1.(6)]	Restricted to Partial Automatic ON ⁽²⁾ [see 4.2.2.1.(8)]	Bi-Level [see 4.2.2.1.(9)]	Automatic Daylight Responsive Controls for Sidelighting [see 4.2.2.1.(10)] ⁽³⁾	Automatic Daylight Responsive Controls for Toplighting [see 4.2.2.1.(13)] ⁽⁴⁾	Automatic Partial OFF [see 4.2.2.1.(16)]	Automatic Full OFF ⁽⁵⁾ [see 4.2.2.1.(18)]	Scheduled Shut-off [see 4.2.2.1.(20)]
Laboratory for classroom other	11.9 14.3	X X	A A	A A	X X	X X	X X	X -	B B	B B
Laundry/Washing area	5.7	X	A	A	X	X	X	-	B	B
Loading dock – interior	9.5	X	A	A	-	X	X	-	B	B
Lobby for elevator for hotel for motion picture theatre for performing arts theatre for space designed to ANSI/IES RP-28 (and used primarily by residents) other	7.0 5.4 2.5 13.5 18.2 9.0	X X X X X X	- - - - - -	- - - - - -	- - - - - -	X X X X X X	X X X X X X	- - - X X X	B B B B B B	B B B B B B
Locker room	5.6	X	A	A	X	X	X	-	X	-
Lounge/Break room for healthcare facility other	4.5 6.3	X X	A A	A A	X X	X X	X X	- -	X X	- -
Office enclosed, ≤ 25 m ² enclosed, > 25 m ² open plan	8.0 7.1 6.6	X X X	A A A	A A A	X X X	X X X	X X X	- - -	X B B	- B B
Pharmacy area	17.9	X	A	A	X	X	X	-	B	B
Sales area ⁽⁷⁾	11.3	X	A	A	X	-	X	-	B	B

4.2.1.6.

Division B

Table 4.2.1.6. (Continued)

Space Type	Lighting Power Density, W/m ²	Type of Lighting Control ⁽¹⁾									
		Manual [see 4.2.2.1.(3)]	Restricted to Manual ON [see 4.2.2.1.(6)]	Restricted to Partial Automatic ON ⁽²⁾ [see 4.2.2.1.(8)]	BI-Level [see 4.2.2.1.(9)]	Automatic Daylight Responsive Controls for Sidelighting [see 4.2.2.1.(10)] ⁽³⁾	Automatic Daylight Responsive Controls for Toplighting [see 4.2.2.1.(13)] ⁽⁴⁾	Automatic Partial OFF [see 4.2.2.1.(16)]	Automatic Full OFF ⁽⁵⁾ [see 4.2.2.1.(18)]	Scheduled Shut-off [see 4.2.2.1.(20)]	
Seating area – general	2.5	X	A	A	-	X	X	-	B	B	
Stairway		The LPD and lighting control requirements for a stairway shall be the same as those for the space containing the stairway.									
Stairwell	5.3	X	-	-	X	X	X	X	B	B	
Parking garage – interior	1.5	See Article 4.2.2.2.									
Storage room											
< 5 m ²	5.5	X	-	-	-	-	-	-	B	B	
≥ 5 m ²	4.1	X	A	A	-	X	X	-	X	-	
Vehicle maintenance area	6.5	X	A	A	X	X	X	-	B	B	
Washroom											
for space designed to ANSI/IES RP-28 (and used primarily by residents)	13.5	X	-	-	-	X	X	X	X	-	
other	6.8	X	-	-	-	X	X	-	X	-	
Workshop	13.5	X	A	A	X	X	X	-	B	B	
Building-Specific Space Types⁽⁶⁾											
Convention centre – exhibit space	6.6	X	A	A	X	X	X	X	B	B	
Dormitory – living quarters	5.4	X	-	-	-	-	-	-	-	-	
Fire station – sleeping quarters	2.5	X	-	-	-	-	-	-	-	-	
Gymnasium/Fitness centre											
exercise area	9.6	X	A	A	X	X	X	X	B	B	
playing area	9.2	X	A	A	X	X	X	X	B	B	
Healthcare facility											
exam/treatment room	15.1	X	-	-	X	X	X	X	B	B	
imaging room	10.1	X	-	-	X	X	X	-	B	B	

Table 4.2.1.6. (Continued)

Space Type	Lighting Power Density, W/m ²	Type of Lighting Control ⁽¹⁾							Automatic Full OFF ⁽⁶⁾ [see 4.2.2.1.(18)]	Scheduled Shut-off [see 4.2.2.1.(20)]
		Manual [see 4.2.2.1.(3)]	Restricted to Manual ON [see 4.2.2.1.(6)]	Restricted to Partial Automatic ON ⁽²⁾ [see 4.2.2.1.(8)]	Bi-Level [see 4.2.2.1.(9)]	Automatic Daylight Responsive Controls for Sidelighting [see 4.2.2.1.(10)] ⁽³⁾	Automatic Daylight Responsive Controls for Toplighting [see 4.2.2.1.(13)] ⁽⁴⁾	Automatic Partial OFF [see 4.2.2.1.(16)]		
medical supply room	6.7									
nursery	9.9	X	-	-	X	X	X	-	B	B
nurses' station	12.6	X	-	-	X	X	X	-	B	B
operating room	24.3	X	-	-	X	-	-	-	B	B
patient room	7.3	X	-	-	X	X	X	-	B	B
physical therapy room	9.8	X	-	-	X	X	X	-	B	B
recovery room	13.5	X	-	-	X	X	X	-	B	B
Library										
reading area	10.3	X	A	A	X	X	X	-	B	B
stacks	12.7	X	A	A	X	X	X	X	B	B
Manufacturing facility										
detailed manufacturing area	8.6	X	A	A	X	X	X	-	B	B
equipment room	8.2	X	A	A	X	X	X	-	B	B
extra high bay area (> 15 m floor-to-ceiling height)	15.3	X	A	A	X	X	X	-	B	B
high bay area (7.5 m to 15 m floor-to-ceiling height)	13.4	X	A	A	X	X	X	-	B	B
low bay area (< 7.5 m floor-to-ceiling height)	9.3	X	A	A	X	X	X	-	B	B
Museum										
general exhibition area	3.3	X	A	A	X	X	X	-	B	B
restoration room	11.9	X	A	A	X	X	X	-	B	B
Post office – sorting area	8.1	X	A	A	X	X	X	X	B	B
Religious building										
fellowship hall	5.8	X	A	A	X	X	X	-	B	B

See Storage Room under Common Space Types for applicable control requirements.

4.2.1.6.

Division B

Table 4.2.1.6. (Continued)

Space Type	Lighting Power Density, W/m ²	Type of Lighting Control ⁽¹⁾								
		Manual [see 4.2.2.1.(3)]	Restricted to Manual ON [see 4.2.2.1.(6)]	Restricted to Partial Automatic ON ⁽²⁾ [see 4.2.2.1.(8)]	Bi-Level [see 4.2.2.1.(9)]	Automatic Daylight Responsive Controls for Sidelighting [see 4.2.2.1.(10)] ⁽³⁾	Automatic Daylight Responsive Controls for Toplighting [see 4.2.2.1.(13)] ⁽⁴⁾	Automatic Partial OFF [see 4.2.2.1.(16)]	Automatic Full OFF ⁽⁵⁾ [see 4.2.2.1.(18)]	Scheduled Shut-off [see 4.2.2.1.(20)]
worship/pulpit/choir area	9.2	X	A	A	X	X	X	-	B	B
Retail facility										
dressing/fitting room	5.4	X	A	A	X	-	X	-	X	-
mall concourse	8.8	X	A	A	X	X	X	-	B	B
Space designed to ANSI/IES RP-28										
chapel (used primarily by residents)	7.5	X	A	A	X	X	X	-	B	B
recreation room (used primarily by residents)	19.0	X	A	A	X	X	X	-	B	B
Sports arena – playing area										
Class I facility ⁽⁶⁾	31.6	X	A	A	X	X	X	-	B	B
Class II facility ⁽⁶⁾	21.6	X	A	A	X	X	X	-	B	B
Class III facility ⁽⁶⁾	13.9	X	A	A	X	X	X	-	B	B
Class IV facility ⁽⁶⁾	9.3	X	A	A	X	X	X	-	B	B
Transportation facility										
airport concourse	2.7	X	A	A	-	X	X	-	B	B
baggage/carousel area	4.2	X	A	A	-	X	X	-	B	B
terminal ticket counter	5.5	X	A	A	X	X	X	-	B	B
Warehouse – storage area										
medium to bulky palletized items	3.6	X	A	A	X	X	X	X	B	B
small hand-carried items ⁽⁶⁾	7.4	X	A	A	X	X	X	X	B	B

Notes to Table 4.2.1.6.:

(1) X: all lighting controls marked with an "X" must be implemented in this space type

A/B: at least one of the lighting controls marked with an "A" and at least one of those marked with a "B" must be implemented in this space type

Table 4.2.1.6. (Continued)

- (dash): this lighting control is not required to be implemented in this space type
- (2) Controls meeting the requirements for “Partial Automatic ON” in Sentence 4.2.2.1.(8) also comply with the requirements for “Bi-Level” lighting control in Sentence 4.2.2.1.(9).
- (3) Automatic daylight responsive controls for *sidelighting* are required only under the conditions stipulated in Sentence 4.2.2.1.(10).
- (4) Automatic daylight responsive controls for *toplighting* are required only under the conditions stipulated in Sentence 4.2.2.1.(13).
- (5) Controls meeting the requirements for “Automatic Full OFF” in Sentence 4.2.2.1.(18) also comply with the requirements for “Automatic Partial OFF” lighting control in Sentence 4.2.2.1.(16).
- (6) In cases where a space type is listed both as a common space type and a *building-specific* space type, the requirements for the latter shall apply. See Note A-Table 4.2.1.6.
- (7) See Sentence 4.2.2.6.(1) for requirements on accent lighting.
- (8) See Note A-Table 4.2.1.6.

4.2.2.1.**4.2.2. Interior Lighting Controls****4.2.2.1. Interior Lighting Controls**

(See Note A-4.2.2.1.)

- 1)** Except as provided in Sentence (2), *interior lighting* controls shall be installed in accordance with this Article for each space type in the *building*.
- 2)** Where the LPD requirements are determined in accordance with the space-by-space method described in Article 4.2.1.6., the same space types shall be used to determine the applicable lighting control requirements from Table 4.2.1.6.
- 3)** At least one manual lighting control device shall be installed in conformance with Sentence (4) in each space type listed in Table 4.2.1.6. to control all the lighting
 - a) in each area less than or equal to 250 m², where the area of the space is less than or equal to 1 000 m², and
 - b) in each area less than or equal to 1 000 m², where the area of the space is greater than 1 000 m².
- 4)** Except as provided in Sentence (5), manual lighting control devices referred to in Sentence (3) shall be installed in a readily accessible location from which occupants can see the controlled lighting.
- 5)** Manual lighting control devices are permitted to be located remotely for reasons of safety or security, provided each control device
 - a) has an indicator pilot light that is integral or adjacent to the control device, and
 - b) bears a label identifying which lighting it controls.
- 6)** Except as provided in Sentence (7), none of the lighting in spaces requiring controls that are restricted to “Manual ON” in accordance with Table 4.2.1.6. shall turn on automatically.
- 7)** Sentence (6) need not apply where “Manual ON” operation of the *general lighting* would endanger the safety or security of the *building* occupants.
- 8)** Up to 50% of the lighting power for the *general lighting*, and for no other lighting, in spaces requiring controls that are restricted to “Partial Automatic ON” in accordance with Table 4.2.1.6. is permitted to turn on automatically.
- 9)** The *general lighting* in spaces requiring “Bi-Level” lighting control in accordance with Table 4.2.1.6. shall have controls that allow at least one intermediate level of lighting, in addition to “full ON” and “full OFF,” that is between 30% and 70% full lighting power, or continuous dimming.
- 10)** Except as provided in Sentence (12), the *general lighting* in primary and secondary sidelighted areas, as applicable, in spaces requiring “Automatic Daylight Responsive Controls for *Sidelighting*” in accordance with Table 4.2.1.6. shall be separately controlled by photocontrols that comply with Sentence (11), where
 - a) the combined input power of all the *general lighting* that is completely or partially within the primary sidelighted areas is 150 W or greater, or
 - b) the combined input power of all the *general lighting* that is completely or partially within the primary and secondary sidelighted areas is 300 W or greater.
- 11)** The photocontrols required in Sentence (10) shall
 - a) reduce electric lighting power in response to available daylight through
 - i) at least one intermediate level of lighting that is equivalent to 50% to 70% of design lighting power, at least one other intermediate level of lighting that is equivalent to 20% to 40% of design lighting power, or the lowest dimming level the technology allows, as well as a control point that turns off all the controlled lighting, or
 - ii) continuous dimming,

- b) control the *general lighting* in the secondary sidelighted area independently of the *general lighting* in the primary sidelighted area, and
- c) be readily accessible for calibration adjustments.

(See Note A-4.2.2.1.(11) and (14).)

12) *General lighting* in the following areas need not comply with Sentence (10):

- a) primary sidelighted areas where the vertical projected distance from the top of the windows to the top of any adjacent structure divided by the horizontal distance from the window to the adjacent structure is greater than or equal to 2,
- b) sidelighted areas where the total glazing area is less than 2 m², and
- c) retail spaces.

13) Except as provided in Sentence (15), the *general lighting* in daylighted areas under *skylights* and roof monitors in spaces requiring “Automatic Daylight Responsive Controls for *Toplighting*” in accordance with Table 4.2.1.6. shall be controlled by photocontrols that comply with Sentence (14), where the combined input power of all the *general lighting* that is completely or partially within the daylighted areas under *skylights* and under roof monitors is 150 W or greater.

14) The photocontrols required in Sentence (13) shall

- a) reduce electric lighting power in response to available daylight through
 - i) at least one intermediate level of lighting that is equivalent to 50% to 70% of design lighting power, at least one other intermediate level of lighting that is equivalent to 20% to 40% of design lighting power, or the lowest dimming level the technology allows, as well as a control point that turns off all the controlled lighting, or
 - ii) continuous dimming,
- b) control the *general lighting* in overlapping toplighted and sidelighted areas together with the *general lighting* in the daylighted areas under *skylights* or roof monitors, and
- c) be readily accessible for calibration adjustments.

(See Note A-4.2.2.1.(11) and (14).)

15) *General lighting* in the following areas need not comply with Sentence (13):

- a) daylighted areas under *skylights* and roof monitors where it can be demonstrated that existing adjacent structures or natural objects block direct sunlight for more than 1 500 hours per year between 8 a.m. and 4 p.m.,
- b) daylighted areas where the visual transmittance, VT, of the *skylights* and roof monitors is less than 0.4, and
- c) spaces in *buildings* located above the 55°N latitude where the input power of the *general lighting* within daylighted areas is less than 200 W.

16) Except as provided in Sentence (17), the power for *general lighting* in spaces requiring controls that are “Automatic Partial OFF” in accordance with Table 4.2.1.6. shall automatically reduce by 50% or more within 20 min of the space being unoccupied.

17) *General lighting* need not be controlled in accordance with Sentence (16) where

- a) the lighting power density for the space is not greater than 8.6 W/m²,
- b) the space is lit by high-intensity discharge (HID) lamps, and
- c) the power for the *general lighting* in the space reduces automatically by 30% or more within 20 min of the space being unoccupied.

18) Except as provided in Sentence (19), the lighting in spaces requiring controls that are “Automatic Full OFF” in accordance with Table 4.2.1.6. shall be controlled by automatic control devices that shut off the lighting within 20 min of the space being unoccupied, where each automatic control device controls an area not greater than 50 m².

19) The following lighting applications need not comply with Sentence (18):

- a) *general lighting* and task lighting in shop and laboratory classrooms,

- b) *general lighting* and task lighting in spaces where automatic shut-off would endanger the safety or security of the *building* occupants, and
- c) lighting required to operate continuously due to operational requirements.

20) Except as provided in Sentence (23), the lighting in spaces requiring controls that are “Scheduled Shut-off” in accordance with Table 4.2.1.6. shall shut off automatically during periods when the spaces are scheduled to be unoccupied by means of control devices complying with Sentence (21) that are

- a) time-of-day operated control devices that automatically turn the lighting off at programmed times, or
- b) signals from other automatic control devices or alarm/security systems.

21) A control device installed to meet the requirements of Sentence (20) shall control the lighting for an area of not more than 2 500 m² on not more than one floor.

22) Any manual control device installed to override the “Scheduled Shut-off” control device required in Sentence (20) shall

- a) turn the lighting on for 2 h or less per activation during scheduled “off” periods, and
- b) control an area of 500 m² or less.

23) Lighting need not be controlled in accordance with Sentence (20) where it is

- a) required to operate continuously due to operational requirements,
- b) located in spaces where patient care is rendered, or
- c) located in spaces where automatic shut-off would endanger the safety or security of the *building* occupants.

4.2.2.2. Lighting Controls in Storage Garages

1) Lighting in a *storage garage* shall be divided into zones no larger than 360 m².

2) Except as provided in Sentence (5), the lighting power in a lighting zone referred to in Sentence (1) shall be controlled by a device that automatically reduces the lighting power by at least 30% when no activity is detected for 20 min.

3) Lighting for covered vehicle entrances and *exits* from *storage garages* shall be separately controlled by a device that automatically reduces the lighting by at least 50% from sunset to sunrise. (See Note A-4.2.2.2.(3).)

4) Except as provided in Sentence (5), where the combined input of all luminaires within 6.1 m of any perimeter wall having a net opening-to-wall ratio of at least 40% and no exterior obstructions within 6.1 m exceeds 150 W, the power to those luminaires shall be automatically reduced in response to daylight.

5) Daylight transition zones and ramps without parking need not comply with the provisions of Sentences (1), (2) and (4).

4.2.2.3. Determination of Primary and Secondary Sidelighted Areas

(See Note A-4.2.2.3.)

1) The total primary sidelighted area shall refer to the combined primary sidelighted areas without double-counting overlapping areas. (See Note A-4.2.2.3.(1) and (5).)

2) Each primary sidelighted area, which is the floor area directly adjacent to vertical glazing below the ceiling, shall be calculated as the product of the width of the primary sidelighted area, as determined in Sentence (3), and its depth, as determined in Sentence (4).

3) The width of the primary sidelighted area shall be calculated as the width of the window plus, on each side, the smaller of the following values:

- a) ½ of the window head height, or
- b) the distance to any vertical obstruction that is 1.5 m or more in height.

- 4)** The depth of the primary sidelighted area shall be calculated as the horizontal distance perpendicular to the glazing that is the smaller of the following values:
- one window head height, which is the distance from the floor to the top of the glazing, or
 - the distance to any vertical obstruction that is 1.5 m or more in height.
- 5)** The total secondary sidelighted area shall refer to the combined secondary sidelighted areas without double-counting overlapping areas. (See Note A-4.2.2.3.(1) and (5).)
- 6)** Each secondary sidelighted area, which is the floor area directly adjacent to a primary sidelighted area, shall be calculated as the product of the width of the secondary sidelighted area, as determined in Sentence (7), and its depth, as determined in Sentence (8).
- 7)** Except as provided in Sentence (9), the width of a secondary sidelighted area shall be calculated as the width of the window plus, on each side, the smaller of the following values:
- $\frac{1}{2}$ of the window head height, or
 - the distance to any vertical obstruction that is 1.5 m or more in height.
- 8)** Except as provided in Sentence (9), the depth of a secondary sidelighted area shall be calculated as the horizontal distance perpendicular to the glazing, which begins at the primary sidelighted area and ends at the smaller of the following values:
- one window head height, which is the distance from the floor to the top of the glazing, or
 - the distance to any vertical obstruction that is 1.5 m or more in height.
- 9)** Where the adjacent primary sidelighted area ends at a vertical obstruction that is 1.5 m or higher or extends beyond the limit of an adjacent daylighted area under *skylight* or primary sidelighted area, then no secondary sidelighted area exists beyond such obstruction or the limit of such areas.

4.2.2.4. Determination of Daylighted Area Under Roof Monitors

(See Note A-4.2.2.4.)

- 1)** The daylighted area under roof monitors shall refer to the combined daylighted area under each roof monitor without double-counting overlapping areas. (See Note A-4.2.2.4.(1) and 4.2.2.5.(1).)
- 2)** The daylighted area under each roof monitor shall be calculated as the product of Clauses (a) and (b):
- the width of the vertical glazing above the ceiling plus the smallest of the following measurements applied to each side of the glazing:
 - 0.6 m,
 - the distance to any vertical obstruction that is 1.5 m or more in height, or
 - the distance to the edge of any primary sidelighted area, and
 - the smallest of the following measurements applied horizontally from the bottom edge of the glazing:
 - the monitor's sill height, which is the vertical distance from the floor to the bottom edge of the monitor's glazing, or
 - the distance to the nearest face of any vertical obstruction where any part of the obstruction is farther away than the difference between the height of the obstruction and the monitor's sill height.

(See Note A-4.2.2.4.(2).)

4.2.2.5. Determination of Daylighted Area Under Skylights

- 1)** The daylighted area under *skylights* shall refer to the combined daylighted area under each *skylight* without double-counting overlapping areas. (See Note A-4.2.2.4.(1) and 4.2.2.5.(1).)
- 2)** The daylighted area under each *skylight* shall be calculated as the area of the *skylight's* projection from the ceiling onto the floor plus the horizontal distances

extending from that projection assessed separately in each direction using the smallest of the following values:

- a) 70% of the *ceiling height*,
- b) the distance to any primary sidelighted area, as determined in accordance with Article 4.2.2.3., or the daylighted area under roof monitors, or
- c) the distance to the nearest face of any vertical obstruction where any part of the obstruction is farther away than 70% of the distance between the top of the obstruction and the ceiling.

(See Note A-4.2.2.5.(2).)

4.2.2.6. Special Applications

1) The following lighting applications shall be controlled separately from the *general lighting* in all spaces:

- a) display or accent lighting,
- b) lighting in display and merchandising cases,
- c) lighting for non-visual applications, such as plant growth and food warming, and
- d) lighting equipment that is for sale or for demonstrations in lighting education.

2) Except for night lighting in bathrooms that does not exceed 2 W, all lighting and all switched receptacles used for lighting in guest rooms and *suites* in commercial temporary lodgings shall be controlled so that their power supply turns off within 20 min of the space being unoccupied. (See Note A-4.2.2.6.(2).) (See also Note A-5.2.8.3.(1).)

3) Where captive key systems are used to meet the requirements of Sentence (2), they shall be located at the entrance to each guest room and *suite*.

4) All supplemental task lighting, including permanently installed undershelf or undercabinet lighting, shall be controlled by a device that is

- a) integral to the luminaires, or
- b) wall-mounted in a readily accessible location from which the occupant can see the controlled lighting.

4.2.3. Exterior Lighting Power

4.2.3.1. Exterior Lighting

1) *Exterior lighting* allowances shall be based on the lighting zone in which the *building* is located, as determined from Table 4.2.3.1.-A.

Table 4.2.3.1.-A
Lighting Zones Used to Determine Exterior Lighting Allowances
Forming Part of Sentence 4.2.3.1.(1)

Lighting Zone	Description
0	Undeveloped areas within national, provincial or territorial parks, forest land, and rural areas, and other undeveloped areas
1	Developed areas within national, provincial or territorial parks, and rural areas
2	Areas predominantly consisting of residential zoning, neighbourhood business districts, light industrial areas with limited nighttime use, and residential mixed-use areas
3	All other areas
4	High-activity commercial districts

2) The basic site allowance to be applied in the calculation of maximum connected *exterior lighting* power in Sentences (3) to (5) shall not exceed the limits specified in Table 4.2.3.1.-B for the applicable lighting zone.

3) Except as provided in Sentence (6), the connected *exterior lighting* power for each specific *building* exterior application listed in Table 4.2.3.1.-C that is to be

illuminated shall not be greater than the individual allowance for that application taken from Table 4.2.3.1.-C for the applicable lighting zone plus any unused power applied from the basic site allowance listed in Table 4.2.3.1.-B. (See Note A-4.2.3.1.(3).)

Table 4.2.3.1.-B
Basic Site Allowances for Exterior Lighting
 Forming Part of Sentences 4.2.3.1.(2) and (3)

Basic Site Allowance According to Lighting Zone				
Zone 0	Zone 1	Zone 2	Zone 3	Zone 4
No allowance	350 W	400 W	500 W	900 W

4) Except as provided in Sentence (6), the connected *exterior lighting* power for all general *building* exterior applications not listed in Table 4.2.3.1.-C that are to be illuminated shall not be greater than the sum of the individual allowances for these applications provided in Table 4.2.3.1.-D for the applicable lighting zone plus any remaining basic site allowance not used in compliance with Sentence (3). (See Note A-4.2.3.1.(4).)

Table 4.2.3.1.-C
Lighting Power Allowances for Specific Building Exterior Applications
 Forming Part of Sentences 4.2.3.1.(3) and (4)

Exterior Application	Lighting Power Allowances According to Lighting Zone				
	Zone 0	Zone 1	Zone 2	Zone 3	Zone 4
<i>Building facades (facade lighting)</i>	A single luminaire of 25 W or less may be installed for each roadway or parking entry, trail head, and toilet facility, or other locations approved by the <i>authority having jurisdiction</i>	No allowance	1.1 W/m ² for each illuminated wall or surface, or 8.2 W/m for each illuminated wall or surface length	1.6 W/m ² for each illuminated wall or surface, or 12.3 W/m for each illuminated wall or surface length	2.2 W/m ² for each illuminated wall or surface, or 16.4 W/m for each illuminated wall or surface length
Automated teller machines (ATM) and night depositories		135 W per location plus 45 W per additional ATM per location			
Entrances and gatehouse inspection stations at guarded facilities		5.4 W/m ² of covered and uncovered area			
Loading areas for law enforcement, fire, ambulance and other emergency service vehicles		3.8 W/m ² of covered and uncovered area			
Drive-up windows and doors		200 W per drive-through			
Parking near 24-hour retail entrances		400 W per main entry			

5) Except as provided in Sentence (6), the connected *exterior lighting* power for all *building* exterior applications not listed in Table 4.2.3.1.-D that are to be illuminated shall not be greater than the sum of the individual allowances for these applications provided in Table 4.2.3.1.-E for the applicable lighting zone plus any remaining basic site allowance not used in compliance with Sentences (3) and (4). (See Note A-4.2.3.1.(5).)

6) The following *exterior lighting* applications need not comply with Sentences (1) to (5) where the lighting is equipped with an independent control device that complies with the requirements of Subsection 4.2.4.:

- a) specialized signal, directional, and marker lighting associated with transportation,
- b) lighting for advertising and directional signage,
- c) lighting integral to equipment or instrumentation and installed by its manufacturer,
- d) lighting for theatrical purposes, including performance, stage, film and video production,
- e) lighting for athletic activity areas,
- f) temporary lighting,
- g) lighting for industrial production, material handling, transportation sites, and associated storage areas for industrial sites,
- h) lighting for theme elements in theme/amusement parks, and
- i) lighting used to highlight features of art objects, public monuments and designated national or provincial historic sites.

Table 4.2.3.1.-D
Lighting Power Allowances for General Building Exterior Applications
 Forming Part of Sentences 4.2.3.1.(4) and (5)

Exterior Application	Lighting Power Allowances According to Lighting Zone				
	Zone 0	Zone 1	Zone 2	Zone 3	Zone 4
Uncovered Parking Areas Parking areas and drives	No allowances	0.32 W/m ²	0.43 W/m ²	0.65 W/m ²	0.86 W/m ²
<i>Building Grounds</i>	No allowances	1.6 W/m	1.6 W/m	2.0 W/m	2.3 W/m
Walkways less than 3 m wide		1.1 W/m ²	1.1 W/m ²	1.2 W/m ²	1.5 W/m ²
Walkways 3 m wide or greater, plaza areas, special feature areas		7.0 W/m ²	7.0 W/m ²	8.1 W/m ²	10.2 W/m ²
Dining areas		6.5 W/m ²	7.5 W/m ²	7.5 W/m ²	7.5 W/m ²
Stairways		1.3 W/m ²	1.3 W/m ²	1.5 W/m ²	2.3 W/m ²
Pedestrian tunnels		0.32 W/m ²	0.43 W/m ²	0.43 W/m ²	0.43 W/m ²
<i>Landscape lighting</i>					
<i>Exterior Entrances and Exterior Exits</i>	No allowances	46 W/m of opening	46 W/m of opening	69 W/m of opening	69 W/m of opening
Pedestrian and vehicular entrances and exits		2.1 W/m ²	2.7 W/m ²	4.3 W/m ²	4.3 W/m ²
Entry canopies					
Loading docks	No allowances	3.8 W/m ²			
Sales Canopies	No allowances	4.3 W/m ²	4.3 W/m ²	6.5 W/m ²	7.5 W/m ²
Free-standing and attached					
Outdoor Sales	No allowances	2.1 W/m ²	2.1 W/m ²	3.8 W/m ²	5.4 W/m ²
Open areas (including vehicle sales lots)		No allowance	23 W/m	23 W/m	69 W/m
Street frontage for vehicle sales lots in addition to "open area" allowance					

Table 4.2.3.1.-E
Lighting Power Allowances for Building Exterior Applications Not Covered in Article 4.2.3.1.
 Forming Part of Sentence 4.2.3.1.(5)

Exterior Application	Lighting Power Allowances According to Lighting Zone, % of interior lighting power allowance in W/m ²				
	Zone 0	Zone 1	Zone 2	Zone 3	Zone 4
Areas not covered in Article 4.2.3.1.	0%	65%	65%	80%	100%

4.2.4. Exterior Lighting Controls

4.2.4.1. Requirements

- 1)** Except as provided in Sentences (2) and (3), *exterior lighting* shall be controlled by
 - a) astronomical time controls,
 - b) photosensors,
 - c) a combination of photosensors and timer shut-off switch, or
 - d) other types of controls that perform the same function as those referred to in Clauses (a) to (c).
- 2)** Except as provided in Sentence (3), *exterior lighting* designated for dusk-to-dawn operation shall be controlled by
 - a) astronomical time controls, or
 - b) photosensors.
- 3)** *Exterior lighting* for covered vehicle *exterior entrances* or *exterior exits* from *buildings* or *storage garages* need not comply with Sentences (1) and (2) where it is required for safety, security, or eye adaptation. (See also Article 4.2.2.2.)
- 4)** Except as provided in Sentence (5), all *exterior lighting*, including advertising signage and parking lot lighting, shall be equipped with a device that has the capability to automatically reduce the total connected lighting power by at least 30%.
- 5)** *Facade lighting* and *landscape lighting* shall have the capability to shut off automatically.
- 6)** All lighting schedule controllers shall be equipped with backup provisions to retain programming and the time setting for at least 10 h during a power outage.

Section 4.3. Trade-off Path

(See Note A-1.1.2.1.)

4.3.1. General

4.3.1.1. Application

- 1)** Subject to the limitations stated in Article 4.3.1.2., this Section applies to *interior lighting* and lighting controls.

4.3.1.2. Limitation

- 1)** Notwithstanding the requirements of this Section, lighting and lighting controls shall comply with Articles 4.2.1.1. and 4.2.1.2. and Subsections 4.2.3. and 4.2.4.

4.3.1.3. Compliance

- 1)** The total *annual energy consumption* of *interior lighting* in the proposed *building* shall be calculated in accordance with
 - a) Subsection 4.3.2., or
 - b) except as provided in Sentence (4), CSA C873.4, “Building energy estimation methodology – Part 4 – Energy consumption for lighting.”

- 2)** The maximum allowed *annual energy consumption* of *interior lighting* in the reference *building* shall be calculated in accordance with
- Subsection 4.3.3., or
 - except as provided in Sentence (5), CSA C873.4, “Building energy estimation methodology – Part 4 – Energy consumption for lighting.”
- 3)** *Interior lighting* shall be deemed to comply with this Section where
- the total *annual energy consumption* of *interior lighting* in the proposed *building* calculated in accordance with Subsection 4.3.2. is less than or equal to the maximum allowed *annual energy consumption* of *interior lighting* in the reference *building* calculated in accordance with Subsection 4.3.3., or
 - the total *annual energy consumption* of *interior lighting* in the proposed *building* calculated in accordance with CSA C873.4, “Building energy estimation methodology – Part 4 – Energy consumption for lighting,” is less than or equal to the maximum allowed *annual energy consumption* of *interior lighting* in the reference *building* calculated in accordance with that same standard.
- 4)** Where the total *annual energy consumption* of *interior lighting* in the proposed *building* is calculated in accordance with CSA C873.4, “Building energy estimation methodology – Part 4 – Energy consumption for lighting,” the following substitutions shall apply:
- NECB Table 4.3.2.7.-A instead of CSA Table 8,
 - NECB Table 4.3.2.7.-B instead of CSA Table 9,
 - NECB Table 4.3.2.10.-B instead of CSA Table 16, and
 - NECB Articles 4.3.2.3. and 4.3.2.4. instead of CSA Clause 5.3.
- 5)** Where the maximum allowed *annual energy consumption* of *interior lighting* in the reference *building* is calculated in accordance with CSA C873.4, “Building energy estimation methodology – Part 4 – Energy consumption for lighting,” the following qualifications shall apply:
- the lighting power density for each space shall be determined using Table 4.2.1.6., and
 - NECB Sentences 4.3.3.7.(3) and (4) and Article 4.3.3.10. shall be used instead of CSA Clauses 5.5.2, 5.5.3, 5.8.1 and 5.8.2.

4.3.2. Installed Interior Lighting Energy

4.3.2.1. Determination of Installed Interior Lighting Energy

1) The installed *interior lighting* energy, IILE, in $(W \times h)/a$, which is the total *annual energy consumption* of *interior lighting* in all spaces of the proposed *building*, shall be calculated using the following equation:

$$\text{IILE} = \sum_{i=1}^N E_{i,\text{proposed}}$$

where

- i = counter for spaces,
- N = total number of spaces in the proposed *building*, and
- $E_{i,\text{proposed}}$ = *annual energy consumption* of *interior lighting* in a space, in $(W \times h)/a$, calculated in accordance with Sentence (2).

2) The *annual energy consumption* of *interior lighting* in a space, $E_{i,\text{proposed}}$, in $(W \times h)/a$, shall be calculated using the following equation:

$$E_{i,\text{proposed}} = p_i \times [A_{\text{DL},i} \times (t_{\text{eff},\text{day},\text{DL},i} + t_{\text{eff},\text{night},i}) + A_{\text{NDL},i} \times (t_{\text{eff},\text{day},\text{NDL},i} + t_{\text{eff},\text{night},i})]$$

where

- p_i = lighting power density in the space, in W/m^2 , determined in accordance with Article 4.3.2.2.,
- $A_{\text{DL},i}$ = daylighted area, in m^2 , determined in accordance with Article 4.3.2.3.,
- $A_{\text{NDL},i}$ = non-daylighted area, in m^2 , determined in accordance with Article 4.3.2.4.,

- $t_{\text{eff,day,DL},i}$ = effective annual daytime operational time of daylighted area, in h/a, determined in accordance with Article 4.3.2.5.,
- $t_{\text{eff,day,NDL},i}$ = effective annual daytime operational time of non-daylighted area, in h/a, determined in accordance with Article 4.3.2.5., and
- $t_{\text{eff,night},i}$ = effective annual nighttime operational time, in h/a, determined in accordance with Article 4.3.2.5.

4.3.2.2. Determination of Lighting Power Density

1) The lighting power density for a space, p_i , in W/m², shall be calculated using the following equation:

$$p_i = \frac{P_i}{A_i}$$

where

- P_i = lighting power in the space, in W, and
 A_i = gross interior floor area of that space, in m².

4.3.2.3. Determination of Daylighted Area

1) Subject to the limitations stated in Sentence (2), the daylighted area of a space, $A_{\text{DL},i}$, in m², shall be determined in accordance with Article 4.2.2.3. for *sidelighting* and Articles 4.2.2.4. (roof monitors) and 4.2.2.5. (*skylights*) for *toplighting*.

2) Where a space is illuminated by both *sidelighting* and *toplighting*, the daylighted area provided by only one of these daylight supplies shall be determined and used in the daylighting calculations in this Section. (See Note A-4.3.2.3.(2).)

4.3.2.4. Determination of Non-Daylighted Area

1) The non-daylighted area of a space, $A_{\text{NDL},i}$, in m², shall be calculated using the following equation:

$$A_{\text{NDL},i} = A_i - A_{\text{DL},i}$$

where

- A_i = gross interior floor area of the space, in m², and
 $A_{\text{DL},i}$ = daylighted area of that space, in m².

4.3.2.5. Determination of Effective Annual Operational Times

1) The effective annual daytime operational time of the daylighted area, $t_{\text{eff,day,DL},i}$, in h/a, shall be calculated using the following equation:

$$t_{\text{eff,day,DL},i} = t_{\text{day},i} \times F_{\text{DL},i} \times F_{\text{occ},i} \times F_{\text{pers},i}$$

where

- $t_{\text{day},i}$ = annual operational time of the space during daytime, in h, determined in accordance with Article 4.3.2.6.,
 $F_{\text{DL},i}$ = factor for daylight harvesting determined in accordance with Article 4.3.2.7.,
 $F_{\text{occ},i}$ = factor for occupancy control determined in accordance with Article 4.3.2.10., and
 $F_{\text{pers},i}$ = factor for personal control determined in accordance with Article 4.3.2.10.

2) The effective annual daytime operational time of the non-daylighted area, $t_{\text{eff,day,NDL},i}$, in h/a, shall be calculated using the following equation:

$$t_{\text{eff,day,NDL},i} = t_{\text{day},i} \times F_{\text{occ},i} \times F_{\text{pers},i}$$

where

- $t_{\text{day},i}$ = annual operational time of the space during daytime, in h, determined in accordance with Article 4.3.2.6.,
- $F_{\text{occ},i}$ = factor for occupancy control determined in accordance with Article 4.3.2.10., and
- $F_{\text{pers},i}$ = factor for personal control determined in accordance with Article 4.3.2.10.

3) The effective annual nighttime operational time, $t_{\text{eff},\text{night},i}$ in h/a, shall be calculated using the following equation:

$$t_{\text{eff},\text{night},i} = t_{\text{night},i} \times F_{\text{occ},i} \times F_{\text{pers},i}$$

where

- $t_{\text{night},i}$ = annual operational time of the space during nighttime, in h, determined in accordance with Article 4.3.2.6.,
- $F_{\text{occ},i}$ = factor for occupancy control determined in accordance with Article 4.3.2.10., and
- $F_{\text{pers},i}$ = factor for personal control determined in accordance with Article 4.3.2.10.

4.3.2.6. Determination of Operational Times

1) Except as provided in Sentence (3), the annual operational time of each space during daytime, $t_{\text{day},i}$ shall be determined using Table 4.3.2.6.-A.

2) Except as provided in Sentence (3), the annual operational time of each space during nighttime, $t_{\text{night},i}$ shall be determined using Table 4.3.2.6.-B.

3) If the *building* operates for more or less than the default 250 days per year, the data provided in Tables 4.3.2.6.-A and 4.3.2.6.-B shall be linearly adjusted using the following equation:

$$t_{\text{adjusted}} = t_{\text{base}} \times \frac{d_{\text{operation}}}{250}$$

where

- t_{adjusted} = adjusted operational time to be used in the trade-off path, in h,
- t_{base} = base operational time provided in Table 4.3.2.6.-A or 4.3.2.6.-B, and
- $d_{\text{operation}}$ = actual number of annual days of operation of the *building*, in days.

Table 4.3.2.6.-A
Number of Operational Hours of the Building During Daytime, $t_{day,i}$ for Various Start and End Times
 Forming Part of Sentences 4.3.2.6.(1) and (3)

Operation Start Time	Operation End Time																								
	1 a.m.	2 a.m.	3 a.m.	4 a.m.	5 a.m.	6 a.m.	7 a.m.	8 a.m.	9 a.m.	10 a.m.	11 a.m.	12 p.m.	1 p.m.	2 p.m.	3 p.m.	4 p.m.	5 p.m.	6 p.m.	7 p.m.	8 p.m.	9 p.m.	10 p.m.	11 p.m.	12 a.m.	
	$t_{day,i}$ in h/a																								
1 a.m.	0	0	0	0	0	35	155	363	613	863	1,113	1,363	1,613	1,863	2,113	2,363	2,580	2,743	2,879	2,979	3,014	3,014	3,014	3,014	3,014
2 a.m.	-	0	0	0	0	35	155	363	613	863	1,113	1,363	1,613	1,863	2,113	2,363	2,580	2,743	2,879	2,979	3,014	3,014	3,014	3,014	3,014
3 a.m.	-	-	0	0	0	35	155	363	613	863	1,113	1,363	1,613	1,863	2,113	2,363	2,580	2,743	2,879	2,979	3,014	3,014	3,014	3,014	3,014
4 a.m.	-	-	-	0	0	35	155	363	613	863	1,113	1,363	1,613	1,863	2,113	2,363	2,580	2,743	2,879	2,979	3,014	3,014	3,014	3,014	3,014
5 a.m.	-	-	-	-	0	35	155	363	613	863	1,113	1,363	1,613	1,863	2,113	2,363	2,580	2,743	2,879	2,979	3,014	3,014	3,014	3,014	3,014
6 a.m.	-	-	-	-	-	-	119	327	577	827	1,077	1,327	1,577	1,827	2,077	2,327	2,545	2,708	2,843	2,944	2,979	2,979	2,979	2,979	2,979
7 a.m.	-	-	-	-	-	-	-	208	458	708	958	1,208	1,458	1,708	1,958	2,208	2,425	2,588	2,724	2,825	2,860	2,860	2,860	2,860	2,860
8 a.m.	-	-	-	-	-	-	-	-	250	500	750	1,000	1,250	1,500	1,750	2,000	2,217	2,380	2,516	2,617	2,652	2,652	2,652	2,652	2,652
9 a.m.	-	-	-	-	-	-	-	-	-	250	500	750	1,000	1,250	1,500	1,750	1,967	2,130	2,266	2,367	2,402	2,402	2,402	2,402	2,402
10 a.m.	-	-	-	-	-	-	-	-	-	-	250	500	750	1,000	1,250	1,500	1,717	1,880	2,016	2,117	2,152	2,152	2,152	2,152	2,152
11 a.m.	-	-	-	-	-	-	-	-	-	-	-	250	500	750	1,000	1,250	1,467	1,630	1,766	1,867	1,902	1,902	1,902	1,902	1,902
12 p.m.	-	-	-	-	-	-	-	-	-	-	-	-	250	500	750	1,000	1,217	1,380	1,516	1,617	1,652	1,652	1,652	1,652	1,652
1 p.m.	-	-	-	-	-	-	-	-	-	-	-	-	-	250	500	750	967	1,130	1,266	1,367	1,402	1,402	1,402	1,402	1,402
2 p.m.	-	-	-	-	-	-	-	-	-	-	-	-	-	-	250	500	717	880	1,016	1,117	1,152	1,152	1,152	1,152	1,152
3 p.m.	-	-	-	-	-	-	-	-	-	-	-	-	-	-	-	250	467	630	766	867	902	902	902	902	902
4 p.m.	-	-	-	-	-	-	-	-	-	-	-	-	-	-	-	-	217	380	516	617	652	652	652	652	652
5 p.m.	-	-	-	-	-	-	-	-	-	-	-	-	-	-	-	-	-	163	299	400	434	434	434	434	434
6 p.m.	-	-	-	-	-	-	-	-	-	-	-	-	-	-	-	-	-	-	136	237	271	271	271	271	271
7 p.m.	-	-	-	-	-	-	-	-	-	-	-	-	-	-	-	-	-	-	-	101	136	136	136	136	136
8 p.m.	-	-	-	-	-	-	-	-	-	-	-	-	-	-	-	-	-	-	-	-	35	35	35	35	35
9 p.m.	-	-	-	-	-	-	-	-	-	-	-	-	-	-	-	-	-	-	-	-	-	0	0	0	0
10 p.m.	-	-	-	-	-	-	-	-	-	-	-	-	-	-	-	-	-	-	-	-	-	-	0	0	0
11 p.m.	-	-	-	-	-	-	-	-	-	-	-	-	-	-	-	-	-	-	-	-	-	-	-	0	0

4.3.2.6.

Division B

Table 4.3.2.6.-B
Number of Operational Hours of the Building During Nighttime, $t_{night,i}$, for Various Start and End Times
 Forming Part of Sentences 4.3.2.6.(2) and (3)

Operation Start Time	Operation End Time																									
	1 a.m.	2 a.m.	3 a.m.	4 a.m.	5 a.m.	6 a.m.	7 a.m.	8 a.m.	9 a.m.	10 a.m.	11 a.m.	12 p.m.	1 p.m.	2 p.m.	3 p.m.	4 p.m.	5 p.m.	6 p.m.	7 p.m.	8 p.m.	9 p.m.	10 p.m.	11 p.m.	12 a.m.		
1 a.m.	250	500	750	1,000	1,250	1,465	1,595	1,637	1,637	1,637	1,637	1,637	1,637	1,637	1,637	1,637	1,670	1,757	1,871	2,021	2,236	2,486	2,736	2,986		
2 a.m.	-	250	500	750	1,000	1,215	1,345	1,387	1,387	1,387	1,387	1,387	1,387	1,387	1,387	1,420	1,507	1,621	1,771	1,986	2,236	2,486	2,736	2,986		
3 a.m.	-	-	250	500	750	965	1,095	1,137	1,137	1,137	1,137	1,137	1,137	1,137	1,137	1,170	1,257	1,371	1,521	1,736	1,986	2,236	2,486	2,736		
4 a.m.	-	-	-	250	500	715	845	887	887	887	887	887	887	887	887	920	1,007	1,121	1,271	1,486	1,736	1,986	2,236	2,486		
5 a.m.	-	-	-	-	250	465	595	637	637	637	637	637	637	637	670	757	871	1,021	1,236	1,486	1,736	1,986	2,236	2,486		
6 a.m.	-	-	-	-	-	215	345	387	387	387	387	387	387	387	420	507	621	771	986	1,236	1,486	1,736	1,986	2,236		
7 a.m.	-	-	-	-	-	-	131	173	173	173	173	173	173	173	205	292	407	556	771	1,021	1,271	1,521	1,771	2,021		
8 a.m.	-	-	-	-	-	-	-	42	42	42	42	42	42	42	75	162	276	425	640	890	1,140	1,390	1,640	1,890		
9 a.m.	-	-	-	-	-	-	-	-	0	0	0	0	0	0	33	120	234	383	598	848	1,098	1,348	1,598	1,848		
10 a.m.	-	-	-	-	-	-	-	-	0	0	0	0	0	0	33	120	234	383	598	848	1,098	1,348	1,598	1,848		
11 a.m.	-	-	-	-	-	-	-	-	0	0	0	0	0	0	33	120	234	383	598	848	1,098	1,348	1,598	1,848		
12 p.m.	-	-	-	-	-	-	-	-	0	0	0	0	0	0	33	120	234	383	598	848	1,098	1,348	1,598	1,848		
1 p.m.	-	-	-	-	-	-	-	-	0	0	0	0	0	0	33	120	234	383	598	848	1,098	1,348	1,598	1,848		
2 p.m.	-	-	-	-	-	-	-	-	0	0	0	0	0	0	33	120	234	383	598	848	1,098	1,348	1,598	1,848		
3 p.m.	-	-	-	-	-	-	-	-	0	0	0	0	0	0	33	120	234	383	598	848	1,098	1,348	1,598	1,848		
4 p.m.	-	-	-	-	-	-	-	-	0	0	0	0	0	0	33	120	234	383	598	848	1,098	1,348	1,598	1,848		
5 p.m.	-	-	-	-	-	-	-	-	0	0	0	0	0	0	33	120	234	383	598	848	1,098	1,348	1,598	1,848		
6 p.m.	-	-	-	-	-	-	-	-	0	0	0	0	0	0	33	120	234	383	598	848	1,098	1,348	1,598	1,848		
7 p.m.	-	-	-	-	-	-	-	-	0	0	0	0	0	0	33	120	234	383	598	848	1,098	1,348	1,598	1,848		
8 p.m.	-	-	-	-	-	-	-	-	0	0	0	0	0	0	33	120	234	383	598	848	1,098	1,348	1,598	1,848		
9 p.m.	-	-	-	-	-	-	-	-	0	0	0	0	0	0	33	120	234	383	598	848	1,098	1,348	1,598	1,848		
10 p.m.	-	-	-	-	-	-	-	-	0	0	0	0	0	0	33	120	234	383	598	848	1,098	1,348	1,598	1,848		
11 p.m.	-	-	-	-	-	-	-	-	0	0	0	0	0	0	33	120	234	383	598	848	1,098	1,348	1,598	1,848		

4.3.2.7. Determination of Factor for Daylight Harvesting

1) The factor for daylight harvesting, $F_{DL,iv}$, shall be calculated using the following equation:

$$F_{DL,i} = 1 - C_{DL,sup,i} \times C_{DL,ctrl,i} \times C_{EL,ctrl,i}$$

where

- $C_{DL,sup,i}$ = daylight supply factor determined in accordance with Sentences (2) and (3),
- $C_{DL,ctrl,i}$ = daylight system control factor determined in accordance with Sentence (4), and
- $C_{EL,ctrl,i}$ = daylight-dependent control factor for electric lighting determined in accordance with Sentence (5).

- 2)** For spaces where *sidelighting* is the primary daylight supply, the daylight supply factor, $C_{DL,sup,iv}$ shall be determined in accordance with Article 4.3.2.8.
- 3)** For spaces where *toplighting* is the primary daylight supply, the daylight supply factor, $C_{DL,sup,iv}$ shall be determined in accordance with Article 4.3.2.9.
- 4)** The daylight system control factor, $C_{DL,ctrl,iv}$ shall be selected from Table 4.3.2.7.-A. (See Note A-4.3.2.7.(4).)
- 5)** The daylight-dependent control factor for electric lighting, $C_{EL,ctrl,iv}$ shall be selected from Table 4.3.2.7.-B.

Table 4.3.2.7.-A
Daylight System Control Factor, $C_{DL,ctrl,i}$
 Forming Part of Sentences 4.3.1.3.(4), 4.3.2.7.(4) and 4.3.3.7.(4)

Daylight System Control	$C_{DL,ctrl,i}^{(1)}$
Automatic	0.86
Manual	0.5
None	1

Notes to Table 4.3.2.7.-A:

⁽¹⁾ The daylight system control factor accounts for the effect of shading on daylight availability.

Table 4.3.2.7.-B
Daylight-Dependent Control Factor for Electric Lighting, $C_{EL,ctrl,i}^{(1)}$
 Forming Part of Sentences 4.3.1.3.(4), 4.3.2.7.(5) and 4.3.3.7.(5)

Daylight-Dependent Control System	$C_{EL,ctrl,i}$
Automatic dimming	1
Automatic bi-level switching (multi-level photocontrol with at least two control levels)	0.99
Automatic switching (ON/OFF)	0.82
Manual – enclosed office less than 25 m ²	0.51
Manual – all other spaces	0.1
None	0

Notes to Table 4.3.2.7.-B:

⁽¹⁾ See Note A-Table 4.3.2.7.-B.

4.3.2.8. Determination of the Daylight Supply Factor for Sidelighting

1) For spaces where *sidelighting* is the primary daylight supply, the daylight supply factor, $C_{DL,sup,ir}$ shall be calculated using the following equation:

$$C_{DL,sup,i} = \tau_{eff,i} \times C_{DL,sup,raw,i} \times f_{obst,i}$$

where

$\tau_{eff,i}$ = effective luminous transmittance of the *fenestration* providing *sidelighting* calculated in accordance with Sentence (2),

$C_{DL,sup,raw,i}$ = raw daylight supply factor for the rough opening (opening without *fenestration*) calculated in accordance with Sentence (3), and

$f_{obst,i}$ = factor to account for horizontal obstructions calculated in accordance with Sentence (4).

2) The effective luminous transmittance of the *fenestration* providing *sidelighting*, $\tau_{eff,ir}$ shall be calculated using the following equation:

$$\tau_{eff,i} = \tau_{D65,i} \times k_{1,i} \times k_{2,i} \times k_{3,i}$$

where

$\tau_{D65,i}$ = luminous transmittance of the glazing for standard illuminant D65,

$k_{1,i}$ = factor to account for framing defined as the ratio of glazed area to overall area of the opening including area of framing,

$k_{2,i}$ = factor to account for dirt accumulation (if unknown, value shall be set to 0.8), and

$k_{3,i}$ = factor to account for non-perpendicular light incidence (if unknown, value shall be set to 0.85).

3) The raw daylight supply factor for the rough opening, $C_{DL,sup,raw,ir}$ shall be determined using Table 4.3.2.8.

4) The factor to account for horizontal obstructions, $f_{obst,ir}$ shall be calculated using the following equation:

$$\text{For } \gamma_{obst,i} < 60^\circ, f_{obst,i} = \cos(1.5 \times \gamma_{obst,i}), \text{ and}$$

$$\text{For } \gamma_{obst,i} \geq 60^\circ, f_{obst,i} = 0$$

where

$\gamma_{obst,i}$ = angle from the centre of the *fenestration* to the top of the horizontal obstruction, in degrees.

Table 4.3.2.8.
Raw Daylight Supply Factors for Rough Opening in Primary Sidelighted Area, $C_{DL,sup,raw,i}$
Forming Part of Sentence 4.3.2.8.(3)

Design Illuminance, in lx ⁽¹⁾	Orientation of <i>Fenestration</i> Providing <i>Sidelighting</i> ⁽²⁾			
	North	East	South	West
	$C_{DL,sup,raw,i}$ ⁽³⁾			
300	0.72	0.72	0.74	0.73
500	0.59	0.62	0.66	0.64
750	0.50	0.55	0.60	0.57
1000	0.44	0.49	0.55	0.52

Notes to Table 4.3.2.8.:

(1) See Note A-Table 4.3.2.8.

(2) See Note A-4.3.2.3.(2).

Table 4.3.2.8. (Continued)

(3) For spaces requiring “Automatic Daylight Responsive Controls for *Sidelighting*” in primary and secondary sidelighted areas, as described in Sentence 4.2.2.1.(10), $C_{DL, sup, raw, i}$ shall be multiplied by 0.75 and the resulting reduced factor shall be applied to the sum of the primary and secondary sidelighted areas.

4.3.2.9. Determination of the Daylight Supply Factor for Toplighting

1) For spaces where *toplighting* is the primary daylight supply, the daylight supply factor, $C_{DL, sup, i}$ shall be determined using Table 4.3.2.9.-A.

2) The mean daylight factor for *toplighting*, D_i , shall be calculated using the following equation:

$$D_i = \tau_{D65, i} \times k_{skyl, 1, i} \times k_{skyl, 2, i} \times k_{skyl, 3, i} \times \frac{\sum A_{Rb, i}}{A_{RG, i}} \times \eta_{R, i}$$

where

- $\tau_{D65, i}$ = luminous transmittance of the roof glazing for standard illuminant D65,
- $k_{skyl, 1, i}$ = factor to account for framing defined as the ratio of glazed area to overall area of the opening including area of framing (if unknown, value shall be set to 0.7),
- $k_{skyl, 2, i}$ = factor to account for dirt accumulation (if unknown, value shall be set to 0.9),
- $k_{skyl, 3, i}$ = factor to account for non-perpendicular light incidence (if unknown, value shall be set to 0.85),
- $A_{Rb, i}$ = area of the openings providing *toplighting* (area of rough opening), in m²,
- $A_{RG, i}$ = area of the space, in m², and
- $\eta_{R, i}$ = utilization factor determined using Table 4.3.2.9.-B.

3) The room cavity ratio, RCR, shall be calculated using the following equation:

$$RCR = \frac{5 \times H \times (L + W)}{[L \times W]}$$

where

- H = height of the space, in m,
- L = length of the space, in m, and
- W = width of the space, in m.

Table 4.3.2.9.-A
Daylight Supply Factors for Toplighting, $C_{DL, sup, i}$
 Forming Part of Sentence 4.3.2.9.(1)

Design Illuminance, in lx	Classification of the Daylighting Supply		
	Low (2% ≤ D_i < 4%) ⁽¹⁾	Medium (4% ≤ D_i < 7%) ⁽¹⁾	Good (D_i ≥ 7%) ⁽¹⁾
	$C_{DL, sup, i}$		
300	0.81	0.86	0.88
500	0.75	0.82	0.85
750	0.67	0.77	0.82
1 000	0.59	0.73	0.79

Notes to Table 4.3.2.9.-A:

(1) See Sentence (2) to calculate the mean daylight factor for *toplighting*, D_i . For $D_i < 2\%$, $C_{DL, sup, i} = 0$.

Table 4.3.2.9.-B
Utilization Factor, $\eta_{R,i}$, as a Function of Room Cavity Ratio, RCR
 Forming Part of Sentence 4.3.2.9.(2)

RCR ⁽¹⁾	Utilization Factor, ⁽²⁾ $\eta_{R,i}$
0	1.00
0.5	0.98
1	0.95
1.5	0.89
2	0.84
2.5	0.79
3	0.74
4	0.65
5	0.57
6	0.52
7	0.47
8	0.41
9	0.35
10	0.29

Notes to Table 4.3.2.9.-B:

(1) See Sentence (3) to calculate the room cavity ratio, RCR.

(2) The utilization factors are derived based on room reflectances of 70 pc (ceiling cavity)/50 pw (walls)/20 pf (floor cavity).

4.3.2.10. Determination of Factors for Occupancy Control and Personal Control

1) The factor for occupancy control, $F_{occ,i}$ shall be calculated using the following equation:

$$F_{occ,i} = 1 - C_{A,i} \times C_{occ,ctrl,i}$$

where

$C_{A,i}$ = factor to account for the relative absence of occupants in the space determined using Table 4.3.2.10.-A, and

$C_{occ,ctrl,i}$ = factor to account for the occupancy-sensing mechanism determined using Table 4.3.2.10.-B.

2) Except as provided in Sentence (3), the factor for personal control, $F_{pers,i}$ shall be calculated using the following equation:

$$F_{pers,i} = 1 - C_{pers,ctrl,i}$$

where

$C_{pers,ctrl,i}$ = factor to account for personal control determined using Table 4.3.2.10.-A.

3) Where the lighting design does not include personal controls, the factor for personal control, $F_{pers,i}$ shall be set to 1.

Table 4.3.2.10.-A
Factors for Relative Absence of Occupants and Personal Control According to Space Type
 Forming Part of Sentences 4.3.2.10.(1) and (2) and 4.3.3.10.(1)

Common Space Types		
Space Types	Factors	
	Relative Absence of Occupants, $C_{A,i}$	Personal Control, $C_{pers,ctrl,i}$
Atrium		
≤ to 12 m in height	0	0
> 12 m in height	0	0
Audience seating area – permanent		
for auditorium	0.3	0
for convention centre	0.2	0
for gymnasium	0	0
for motion picture <i>theatre</i>	0	0
for penitentiary	0	0
for performing arts <i>theatre</i>	0	0
for religious building	0.3	0
for sports arena	0	0
other	0	0
Banking activity area and offices	0	0
Classroom/Lecture hall/Training room		
for penitentiary	0.5	0
other	0.5	0
Computer/Server room	0.7	0
Conference/Meeting/Multi-purpose room	0.5	0
Confinement cell	0	0
Copy/Print room	0.2	0
Corridor/Transition area		
for hospital	0	0
for manufacturing facility	0	0
for space designed to ANSI/IES RP-28 (used primarily by residents)	0	0
other	0	0
Courtroom	0.2	0
Dining area		
for bar lounge/leisure dining	0	0
for cafeteria or fast-food dining	0	0
for family dining	0	0
for penitentiary	0	0
for space designed to ANSI/IES RP-28 (used primarily by residents)	0	0
other	0	0
Dressing/Fitting room for performing arts <i>theatre</i>	0.4	0
Electrical/Mechanical room	0.9	0
Emergency vehicle garage	0.5	0
Food preparation area	0	0
Guest room	0	0
Laboratory		
for classroom	0.4	0.1
other	0	0

Table 4.3.2.10.-A (Continued)

Common Space Types		
Space Types	Factors	
	Relative Absence of Occupants, $C_{A,i}$	Personal Control, $C_{pers,ctrl,i}$
Laundry/Washing area	0	0
Lobby		
for elevator	0	0
for hotel	0	0
for motion picture <i>theatre</i>	0	0
for performing arts <i>theatre</i>	0	0
for space designed to ANSI/IES RP-28 (used primarily by residents)	0	0
other	0	0
Locker room	0.5	0
Lounge/Break room		
for healthcare facility	0	0
other	0	0
Office		
enclosed	0.3	0.1
open plan	0.2	0.1
Pharmacy area	0	0
Sales area	0	0
Seating area – general	0	0
Stairway	0	0
Stairwell	0	0
<i>Storage garage</i> – interior	0.4	0
Storage room	0.6	0
Vehicle maintenance area	0	0
Washroom		
for space designed to ANSI/IES RP-28 (used primarily by residents)	0.5	0
other	0.5	0
Workshop	0	0
Building-Specific Space Types		
Space Types	Factors	
	Relative Absence of Occupants, $C_{A,i}$	Personal Control, $C_{pers,ctrl,i}$
Convention centre – exhibit space	0	0
Dormitory – living quarters	0	0
Fire station – sleeping quarters	0	0
Gymnasium/Fitness centre		
exercise area	0	0
playing area	0	0

Table 4.3.2.10.-A (Continued)

Building-Specific Space Types		
Space Types	Factors	
	Relative Absence of Occupants, $C_{A,i}$	Personal Control, $C_{pers,ctrl,i}$
Healthcare facility		
exam/treatment room	0.3	0
imaging room	0	0
medical supply room	0.5	0
nursery	0	0
nurses' station	0	0
operating room	0.1	0
patient room	0.1	0.1
physical therapy room	0.2	0
recovery room	0	0
Library		
reading area	0	0
stacks	0	0
Manufacturing facility		
detailed manufacturing area	0	0
equipment room	0.2	0
extra high bay area (> 15 m floor-to-ceiling height)	0	0
high bay area (7.5 m to 15 m floor-to-ceiling height)	0	0
low bay area (< 7.5 m floor-to-ceiling height)	0	0
Museum		
general exhibition area	0.2	0
restoration room	0.3	0
Post office – sorting area	0	0
Religious <i>building</i>		
fellowship hall	0.3	0
worship/pulpit/choir area	0.1	0
Retail facility		
dressing/fitting room	0.4	0
mall concourse	0	0
Space designed to ANSI/IES RP-28		
chapel (used primarily by residents)	0.5	0
recreation room (used primarily by residents)	0.2	0
Sports arena – playing area		
Class I facility ⁽¹⁾	0	0
Class II facility ⁽¹⁾	0	0
Class III facility ⁽¹⁾	0	0
Class IV facility ⁽¹⁾	0	0
Transportation facility		
airport concourse	0	0
baggage/carousel area	0	0
terminal ticket counter	0	0
Warehouse – storage area		
medium to bulky palletized items	0.5	0
small hand-carried items ⁽¹⁾	0.5	0

Table 4.3.2.10.-A (Continued)

Notes to Table 4.3.2.10.-A:

(1) See Note A-Table 4.2.1.6.

Table 4.3.2.10.-B
Factor to Account for Occupancy-Sensing Mechanism, $C_{occ,ctrl,i}$
 Forming Part of Sentences 4.3.1.3.(4), 4.3.2.10.(1) and 4.3.3.10.(1)

Occupancy-Sensing Mechanism	$C_{occ,ctrl,i}$
Automatic full OFF (full ON)	0.67
Automatic full OFF (restricted to manual ON or automatic partial ON)	0.75
Automatic partial OFF (restricted to manual ON)	0.34
Manual (ON/OFF or bi-level) – enclosed office less than 25 m ²	0.30
Manual – all other spaces	0.1
None	0

4.3.3. Interior Lighting Energy Allowance**4.3.3.1. Determination of Interior Lighting Energy Allowance**

1) The *interior lighting* energy allowance, ILEA, in $(W \times h)/a$, which is the maximum allowed *annual energy consumption* of all *interior lighting* complying with the prescriptive lighting power densities determined using the space-by-space method in Article 4.2.1.6. and with the prescriptive lighting controls in Subsection 4.2.2., shall be calculated using the following equation:

$$ILEA = \sum_{i=1}^N E_{i,prescriptive}$$

where

i = counter for spaces,

N = total number of spaces in the proposed *building*, and

$E_{i,prescriptive}$ = *annual energy consumption* for lighting in a space, in $(W \times h)/a$, calculated in accordance with Sentence (2).

2) The *annual energy consumption* for lighting in each space, $E_{i,prescriptive}$, in $(W \times h)/a$, shall be calculated using the following equation:

$$E_{i,prescriptive} = LPD_i \times [A_{DL,i} \times (t_{eff,day,DL,i} + t_{eff,night,i}) + A_{NDL,i} \times (t_{eff,day,NDL,i} + t_{eff,night,i})]$$

where

LPD_i = lighting power density for the space, in W/m^2 , determined in accordance with Article 4.3.3.2.,

$A_{DL,i}$ = daylighted area, in m^2 , determined in accordance with Article 4.3.3.3.,

$A_{NDL,i}$ = non-daylighted area, in m^2 , determined in accordance with Article 4.3.3.4.,

$t_{eff,day,DL,i}$ = effective annual daytime operational time in daylighted area, in h/a , determined in accordance with Article 4.3.3.5.,

$t_{eff,day,NDL,i}$ = effective annual daytime operational time in non-daylighted area, in h/a , determined in accordance with Article 4.3.3.5., and

$t_{eff,night,i}$ = effective annual nighttime operational time, in h/a , determined in accordance with Article 4.3.3.5.

4.3.3.2. Determination of Lighting Power Density

1) The lighting power density for a space, LPD_i , shall be determined using Table 4.2.1.6.

4.3.3.3. Determination of Daylighted Area

1) The daylighted area of a space, $A_{DL,i}$ in m^2 , shall be identical to that for the proposed *building* as determined in Article 4.3.2.3.

4.3.3.4. Determination of Non-Daylighted Area

1) The non-daylighted area of a space, $A_{NDL,i}$ in m^2 , shall be identical to that for the proposed *building* as determined in Article 4.3.2.4.

4.3.3.5. Determination of Effective Annual Operational Times

1) The effective annual daytime operational time of the daylighted area, $t_{eff,day,DL,i}$ in h/a, shall be calculated using the following equation:

$$t_{eff,day,DL,i} = t_{day,i} \times F_{DL,i} \times F_{occ,i} \times F_{pers,i}$$

where

- $t_{day,i}$ = annual operational time of space during daytime, in h, determined in accordance with Article 4.3.3.6.,
- $F_{DL,i}$ = factor for daylight harvesting determined in accordance with Article 4.3.3.7.,
- $F_{occ,i}$ = factor for occupancy control determined in accordance with Article 4.3.3.10., and
- $F_{pers,i}$ = factor for personal control determined in accordance with Article 4.3.3.10.

2) The effective annual daytime operational time of the non-daylighted area, $t_{eff,day,NDL,i}$ in h/a, shall be calculated using the following equation:

$$t_{eff,day,NDL,i} = t_{day,i} \times F_{occ,i} \times F_{pers,i}$$

where

- $t_{day,i}$ = annual operational time of space during daytime, in h, determined in accordance with Article 4.3.3.6.,
- $F_{occ,i}$ = factor for occupancy control determined in accordance with Article 4.3.3.10., and
- $F_{pers,i}$ = factor for personal control determined in accordance with Article 4.3.3.10.

3) The effective annual nighttime operational time, $t_{eff,night,i}$ in h/a, shall be calculated using the following equation:

$$t_{eff,night,i} = t_{night,i} \times F_{occ,i} \times F_{pers,i}$$

where

- $t_{night,i}$ = annual operational time of the space during nighttime, in h, determined in accordance with Article 4.3.3.6.,
- $F_{occ,i}$ = factor for occupancy control determined in accordance with Article 4.3.3.10., and
- $F_{pers,i}$ = factor for personal control determined in accordance with Article 4.3.3.10.

4.3.3.6. Determination of Operational Times

1) Annual operational times, $t_{day,i}$ and $t_{night,i}$ shall be determined in accordance with Article 4.3.2.6.

4.3.3.7. Determination of Factor for Daylight Harvesting

1) The factor for daylight harvesting, $F_{DL,i}$ shall be determined using the following equation:

$$F_{DL,i} = 1 - C_{DL,sup,i} \times C_{DL,ctrl,i} \times C_{EL,ctrl,i}$$

4.3.3.8.

where

- $C_{DL,sup,i}$ = daylight supply factor determined in accordance with Sentences (2) and (3),
- $C_{DL,ctrl,i}$ = daylight system control factor determined in accordance with Sentence (4),
and
- $C_{EL,ctrl,i}$ = daylight-dependent control factor for electric lighting determined in accordance with Sentence (5).

- 2)** For spaces where *sidelighting* is the primary daylight supply, the daylight supply factor, $C_{DL,sup,iv}$ shall be determined in accordance with Article 4.3.2.8.
- 3)** For spaces where *toplighting* is the primary daylight supply, the daylight supply factor, $C_{DL,sup,iv}$ shall be determined in accordance with Article 4.3.2.9.
- 4)** The daylight system control factor, $C_{DL,ctrl,iv}$ shall be set to the daylight system control factor for “manual” stated in Table 4.3.2.7.-A. (See Note A-4.3.3.7.(4).)
- 5)** The daylight-dependent control factor for electric lighting, $C_{EL,ctrl,i}$ shall be determined using Table 4.3.2.7.-B based on the minimum requirement for the applicable space according to the prescriptive path.

4.3.3.8. Reserved

4.3.3.9. Reserved

4.3.3.10. Determination of Factors for Occupancy Control and Personal Control

- 1)** The factor for occupancy control, $F_{occ,iv}$ shall be calculated using the following equation:

$$F_{occ,i} = 1 - C_{A,i} \times C_{occ,ctrl,i}$$

where

- $C_{A,i}$ = factor to account for the relative absence of occupants in the space determined using Table 4.3.2.10.-A, and
- $C_{occ,ctrl,i}$ = factor to account for the occupancy-sensing mechanism determined using Table 4.3.2.10.-B based on the minimum requirement for the applicable space according to the prescriptive path.
- 2)** The factor for personal control, $F_{pers,iv}$ shall be set to 1.

Section 4.4. Performance Path

(See Note A-1.1.2.1.)

4.4.1. General

4.4.1.1. Scope

- 1)** Where the lighting system does not comply with the requirements of Section 4.2. or 4.3., it shall comply with Part 8.

Section 4.5. Objective and Functional Statements

4.5.1. Objective and Functional Statements

4.5.1.1. Attributions to Acceptable Solutions

- 1)** For the purpose of compliance with this Code as required in Clause 1.2.1.1.(1)(b) of Division A, the objective and functional statements attributed to the acceptable solutions in this Part shall be the objective and functional statements listed in Table 4.5.1.1. (See Note A-1.1.3.1.(1).)

Table 4.5.1.1.
Objectives and Functional Statements Attributed to the
Acceptable Solutions in Part 4
 Forming Part of Sentence 4.5.1.1.(1)

Provision	Functional Statements and Objectives ⁽¹⁾
4.2.1.1. Exit Signs	
(1)	[F94-OE1.1]
4.2.1.2. Fluorescent Lamp Ballasts	
(1)	[F94,F98-OE1.1]
(2)	[F94,F98-OE1.1]
4.2.1.3. Limits to Installed Interior Lighting Power	
(1)	[F94-OE1.1]
(3)	[F94-OE1.1]
4.2.1.4. Determination of the Installed Interior Lighting Power	
(1)	[F94-OE1.1]
(2)	[F94-OE1.1]
(3)	[F94-OE1.1]
4.2.1.5. Calculation of Interior Lighting Power Allowance Using the Building Area Method	
(1)	[F94-OE1.1]
(2)	[F94-OE1.1]
(3)	[F94-OE1.1]
(4)	[F94-OE1.1]
(5)	[F94-OE1.1]
4.2.1.6. Calculation of Interior Lighting Power Allowance Using the Space-by-Space Method	
(1)	[F94-OE1.1]
4.2.2.1. Interior Lighting Controls	
(1)	[F94-OE1.1]
(2)	[F94-OE1.1]
(3)	[F94-OE1.1]
(4)	[F94-OE1.1]
(6)	[F94-OE1.1]
(8)	[F94-OE1.1]
(9)	[F94-OE1.1]
(10)	[F94-OE1.1]
(11)	[F94-OE1.1]
(13)	[F94-OE1.1]
(14)	[F94-OE1.1]
(16)	[F94-OE1.1]
(18)	[F94-OE1.1]
(20)	[F94-OE1.1]
(21)	[F94-OE1.1]
(22)	[F94-OE1.1]
4.2.2.2. Lighting Controls in Storage Garages	
(1)	[F94-OE1.1]

Table 4.5.1.1. (Continued)

Provision	Functional Statements and Objectives ⁽¹⁾
(2)	[F94-OE1.1]
(3)	[F94-OE1.1]
(4)	[F94-OE1.1]
4.2.2.3. Determination of Primary and Secondary Sidelighted Areas	
(1)	[F94-OE1.1]
(2)	[F94-OE1.1]
(3)	[F94-OE1.1]
(4)	[F94-OE1.1]
(5)	[F94-OE1.1]
(6)	[F94-OE1.1]
(7)	[F94-OE1.1]
(8)	[F94-OE1.1]
4.2.2.4. Determination of Daylighted Area Under Roof Monitors	
(1)	[F94-OE1.1]
(2)	[F94-OE1.1]
4.2.2.5. Determination of Daylighted Area Under Skylights	
(1)	[F94-OE1.1]
(2)	[F94-OE1.1]
4.2.2.6. Special Applications	
(1)	[F94-OE1.1]
(2)	[F94-OE1.1]
(3)	[F94-OE1.1]
(4)	[F94-OE1.1]
4.2.3.1. Exterior Lighting	
(1)	[F94-OE1.1]
(2)	[F94-OE1.1]
(3)	[F94-OE1.1]
(4)	[F94-OE1.1]
(5)	[F94-OE1.1]
4.2.4.1. Requirements	
(1)	[F94-OE1.1]
(2)	[F94-OE1.1]
(4)	[F94-OE1.1]
(5)	[F94-OE1.1]
(6)	[F94-OE1.1]
4.3.1.3. Compliance	
(1)	[F94-OE1.1]
(2)	[F94-OE1.1]
(3)	[F94-OE1.1]
(4)	[F94-OE1.1]
(5)	[F94-OE1.1]

Table 4.5.1.1. (Continued)

Provision	Functional Statements and Objectives ⁽¹⁾
4.3.2.1. Determination of Installed Interior Lighting Energy	
(1)	[F94-OE1.1]
(2)	[F94-OE1.1]
4.3.2.2. Determination of Lighting Power Density	
(1)	[F94-OE1.1]
4.3.2.3. Determination of Daylighted Area	
(1)	[F94-OE1.1]
(2)	[F94-OE1.1]
4.3.2.4. Determination of Non-Daylighted Area	
(1)	[F94-OE1.1]
4.3.2.5. Determination of Effective Annual Operational Times	
(1)	[F94-OE1.1]
(2)	[F94-OE1.1]
(3)	[F94-OE1.1]
4.3.2.6. Determination of Operational Times	
(1)	[F94-OE1.1]
(2)	[F94-OE1.1]
4.3.2.7. Determination of Factor for Daylight Harvesting	
(1)	[F94-OE1.1]
(4)	[F94-OE1.1]
(5)	[F94-OE1.1]
4.3.2.8. Determination of the Daylight Supply Factor for Sidelighting	
(1)	[F94-OE1.1]
(2)	[F94-OE1.1]
(3)	[F94-OE1.1]
(4)	[F94-OE1.1]
4.3.2.9. Determination of the Daylight Supply Factor for Toplighting	
(1)	[F94-OE1.1]
(2)	[F94-OE1.1]
(3)	[F94-OE1.1]
4.3.2.10. Determination of Factors for Occupancy Control and Personal Control	
(1)	[F94-OE1.1]
(2)	[F94-OE1.1]
(3)	[F94-OE1.1]
4.3.3.1. Determination of Interior Lighting Energy Allowance	
(1)	[F94-OE1.1]
(2)	[F94-OE1.1]
4.3.3.2. Determination of Lighting Power Density	
(1)	[F94-OE1.1]
4.3.3.3. Determination of Daylighted Area	
(1)	[F94-OE1.1]

Table 4.5.1.1. (Continued)

Provision	Functional Statements and Objectives ⁽¹⁾
4.3.3.4. Determination of Non-Daylighted Area	
(1)	[F94-OE1.1]
4.3.3.5. Determination of Effective Annual Operational Times	
(1)	[F94-OE1.1]
(2)	[F94-OE1.1]
(3)	[F94-OE1.1]
4.3.3.7. Determination of Factor for Daylight Harvesting	
(1)	[F94-OE1.1]
(4)	[F94-OE1.1]
(5)	[F94-OE1.1]
4.3.3.10. Determination of Factors for Occupancy Control and Personal Control	
(1)	[F94-OE1.1]
(2)	[F94-OE1.1]

Notes to Table 4.5.1.1.:

(1) See Parts 2 and 3 of Division A.

Division B

Notes to Part 4 Lighting

A-4.1.1.2.(1) Application. Part 4 is intended to apply to all lighting components and systems in or on the building or building site that are connected to the building's electrical service.

A-4.1.1.2.(2)(c) Exemptions. In some cases, the requirements of Part 4 may adversely affect the use of spaces with special functional requirements and so exceptions to the Code requirements may be necessary. Except for particular types of process lighting, however, it is unlikely that a space or lighting system would be exempt from all the requirements of Part 4. Some necessary exceptions to particular requirements are identified in the Code. Exemption should be determined on a case-by-case basis, depending on the space's function, available technologies and cost-effectiveness.

A-4.1.1.3.(1) Compliance. The flow charts in Figures A-4.1.1.3.(1)-A and A-4.1.1.3.(1)-B illustrate the process for all three paths of compliance applicable to Part 4. The prescriptive path options for interior lighting requirements using the building area method or the space-by-space method are also shown in Figure A-4.1.1.3.(1)-B.

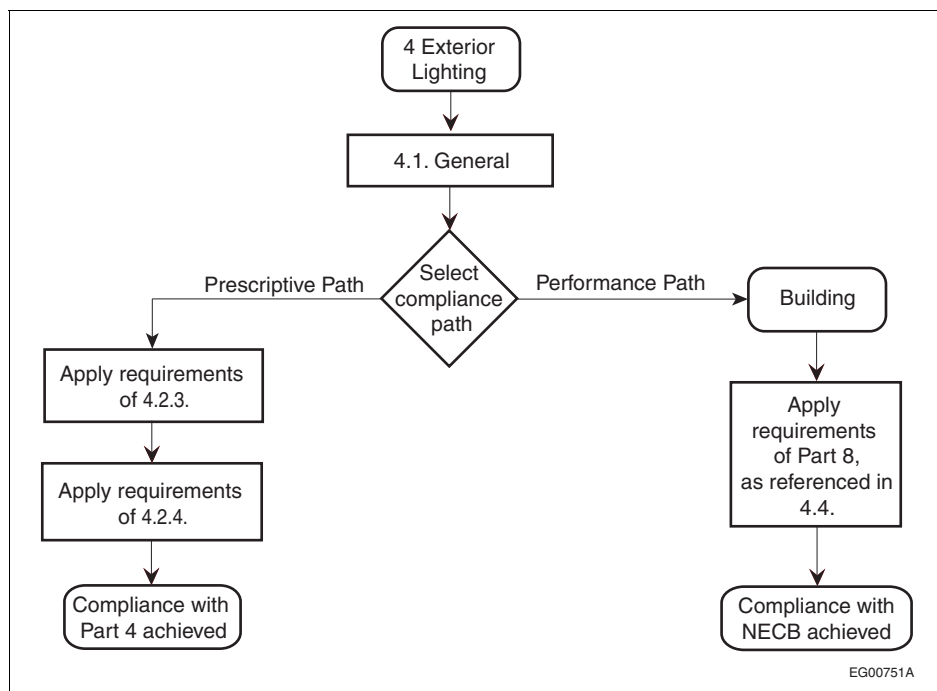

Figure A-4.1.1.3.(1)-A
Code compliance paths for exterior lighting

These Notes are included for explanatory purposes only and do not form part of the requirements. The number that introduces each Note corresponds to the applicable requirement in this Part.

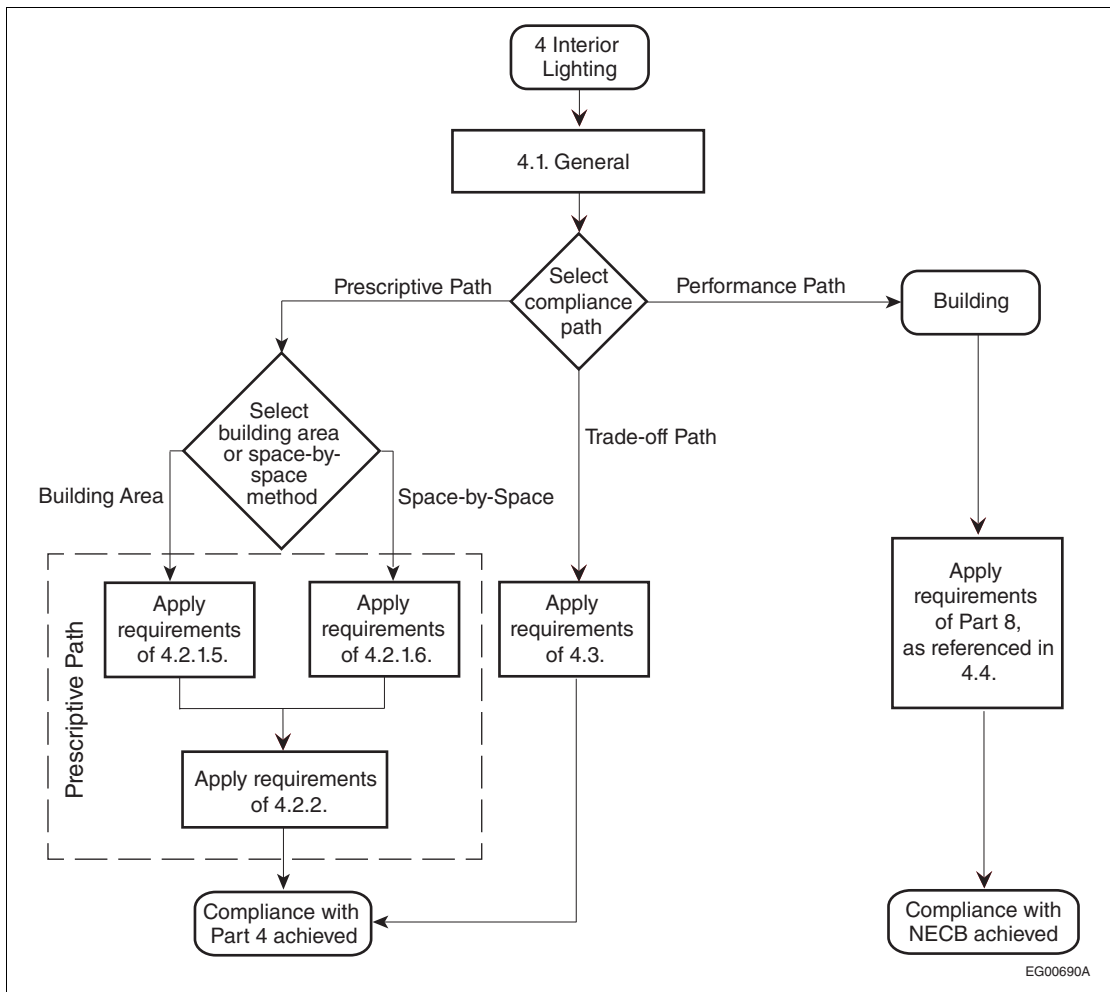

Figure A-4.1.1.3.(1)-B

Code compliance paths for interior lighting

A-4.2.1.3. Prescriptive Compliance with Interior Lighting Power Requirements. The prescriptive criteria in Section 4.2. compare the installed interior lighting power to a permitted interior lighting power allowance.

Mixing the two methods described in Sentence 4.2.1.3.(1) within a building is not permitted.

The building area method is based on building type only and has limited flexibility. The criteria are not sensitive to specific task and room configurations that affect lighting power in any particular building, but permit faster calculations that will be appropriate for typical buildings and normal uses.

The space-by-space method provides greater flexibility but requires a more detailed calculation procedure. It may provide a more appropriate allowance for complex buildings and buildings with multiple spaces and activities.

The building area and space-by-space methods are not to be used as lighting design procedures. Once the interior lighting power allowance for the building has been determined, the designer should strive to design a lighting system that will provide an effective and pleasing illuminated environment without exceeding the interior lighting power allowance or reducing the level of control.

Note that, for flexibility in design, the trade-off path detailed in Section 4.3. or the performance path described in Section 4.4. and Part 8 may be followed in lieu of the interior lighting prescriptive requirements stated in Section 4.2.

A-4.2.1.4.(2) Installed Interior Lighting Power. Where the interior lighting power allowance includes an allowance for a particular space, the installed interior lighting power must also include a reasonable value for connected lighting power for that space. Recognizing that moveable plug-in units are moved, plugged in, unplugged and easily replaced over time, the connected lighting power of moveable and plug-in luminaires is not intended to reflect the actual connected lighting power of these units over the life of the space. Rather, it is to indicate a power level that will support a lighting level appropriate for the initial intended use of the space. Thus, where the design calls for moveable or plug-in luminaires, the designer must select a sufficient quantity and quality of luminaires to provide the necessary lighting level. The installed interior lighting power must include the lighting load for the installation of those typical units.

The installed interior lighting power should reflect the variety and numbers of luminaires in accordance with good lighting design practice, taking into account the intended use of the space lit by the luminaires.

A-4.2.1.4.(3)(a) Auxiliary. The term “auxiliary” includes luminaire components that affect the energy consumption or efficiency of the lighting system other than the lamp such as ballasts, drivers, starters, transformers, active heat sinks, power supplies and sensors.

A-4.2.1.5. Applying the Building Area Method. In the building area method, the interior lighting power allowance is determined by multiplying the gross lighted area of the building by the lighting power density listed in Table 4.2.1.5., which is selected based on the project's building type. It may be permissible on a case-by-case basis to use one of the listed building types for a project whose building type is not listed but whose lighting needs and applicable technologies are similar to those of a listed building type. For instance, an indoor swimming pool might be allowed the lighting power density of an exercise centre but not a workshop.

A single building often has two or more distinct building types, such as a hotel with retail space. If one type comprises more than 10% of the gross lighted area, then the space-by-space method must be used. If one distinct building type is less than 10% of the gross lighted area, either the building area method or the space-by-space method can be used. If the building area method is used, it must be for the building type representing 90% or more of the building area.

A-Table 4.2.1.6. Building Space Types.

Common and Building-Specific

In some cases, a space can be described as both a common space type and a building-specific space type. For example, the medical supply room in a healthcare facility could also be a storage room. As a general rule, the building-specific space type must be used whenever possible; in this case, “medical supply room” should be used.

Sports Arena Facilities

Sports arena facilities can be categorized as:

- Class I - competition play with facilities for 5 000 or more spectators;
- Class II - competition play with facilities for up to 5 000 spectators;
- Class III - competition play with some spectator facilities;
- Class IV - competition or recreational play only with no facilities for spectators.

Warehouse

In a warehouse storage area, the space used to store small hand-carried items is sometimes referred to as a “picking area.”

A-4.2.2.1. Automatic Control Devices. Automatic control devices designed to align the lighting of a space with the presence of occupants can include occupant sensors such as motion sensors, presence sensors, vacancy sensors, and other similar devices (occupant sensors are devices that detect the presence of people within an area and cause lighting, equipment or appliances to be regulated accordingly).

Products that allow for on-site calibration of their sensitivity are recommended as they allow situations of false tripping to be managed.

Using controllable circuit breakers as a means of automatic control is only permitted when they are connected to sensors.

A-4.2.2.1.(11) and (14) Automatic Daylighting Controls. Calibration adjustments are generally made with a remotely mounted controller, but can also be made with handheld devices that communicate with the photocontrol sensor or other system devices, such as continuous dimming devices.

The two intermediate levels of lighting referred to in Subclauses (11)(a)(i) and (14)(a)(i) can be achieved with selective lamp extinguishing or stepped dimming ballasts.

A-4.2.2.2.(3) Covered Vehicle Entrances and Exits from Storage Garages. A mid-luminance zone is needed for transitioning from a high-luminance zone (garage) to a low-luminance zone (street)—or vice versa—at night. This mid-luminance zone has a lower electrical lighting intensity than the high-luminance zone, resulting in energy savings.

A-4.2.2.3. Primary and Secondary Sidelighted Areas. Figures A-4.2.2.3.-A and A-4.2.2.3.-B illustrate how to determine primary and secondary sidelighted areas.

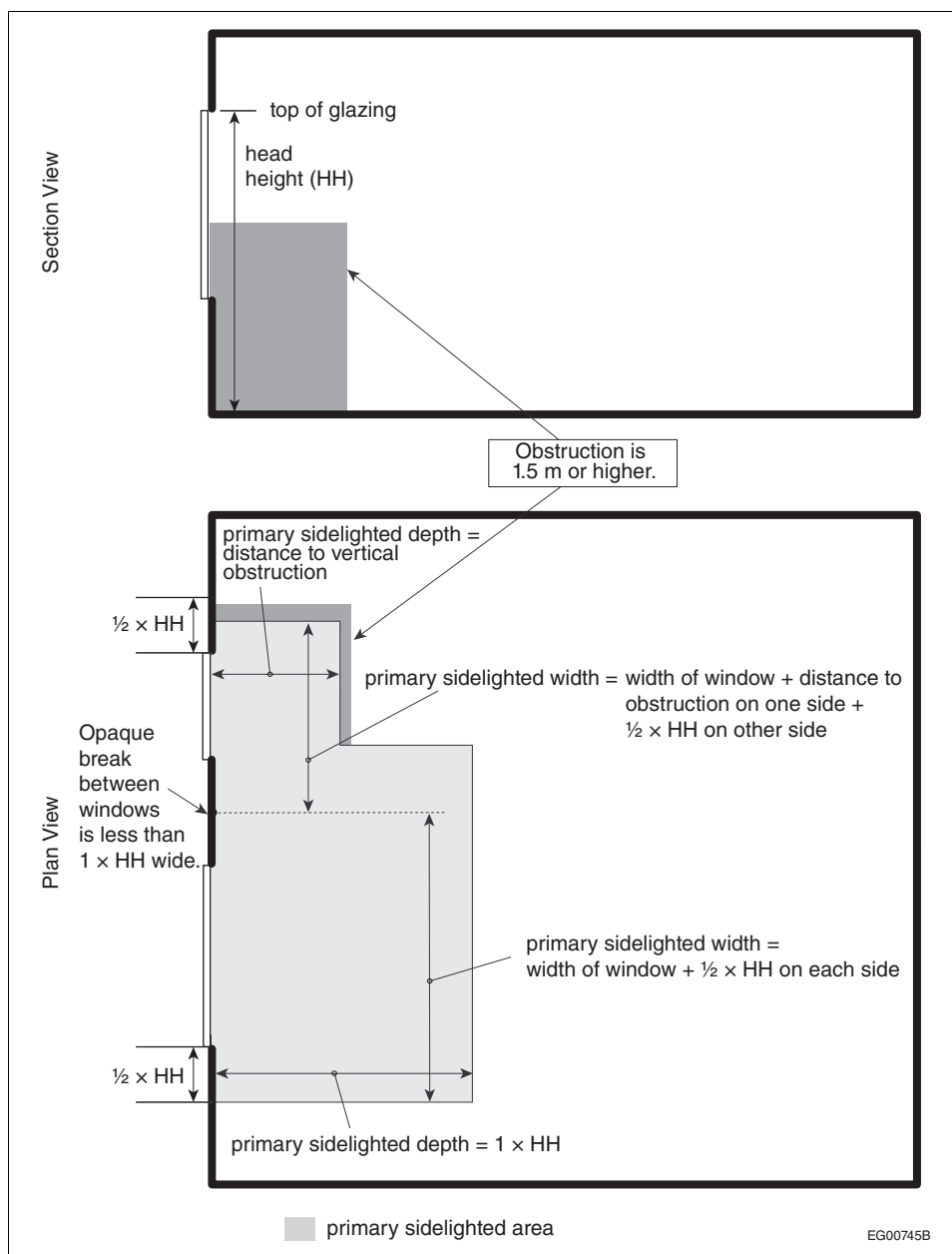

Figure A-4.2.2.3.-A
Determining primary sidelighted areas

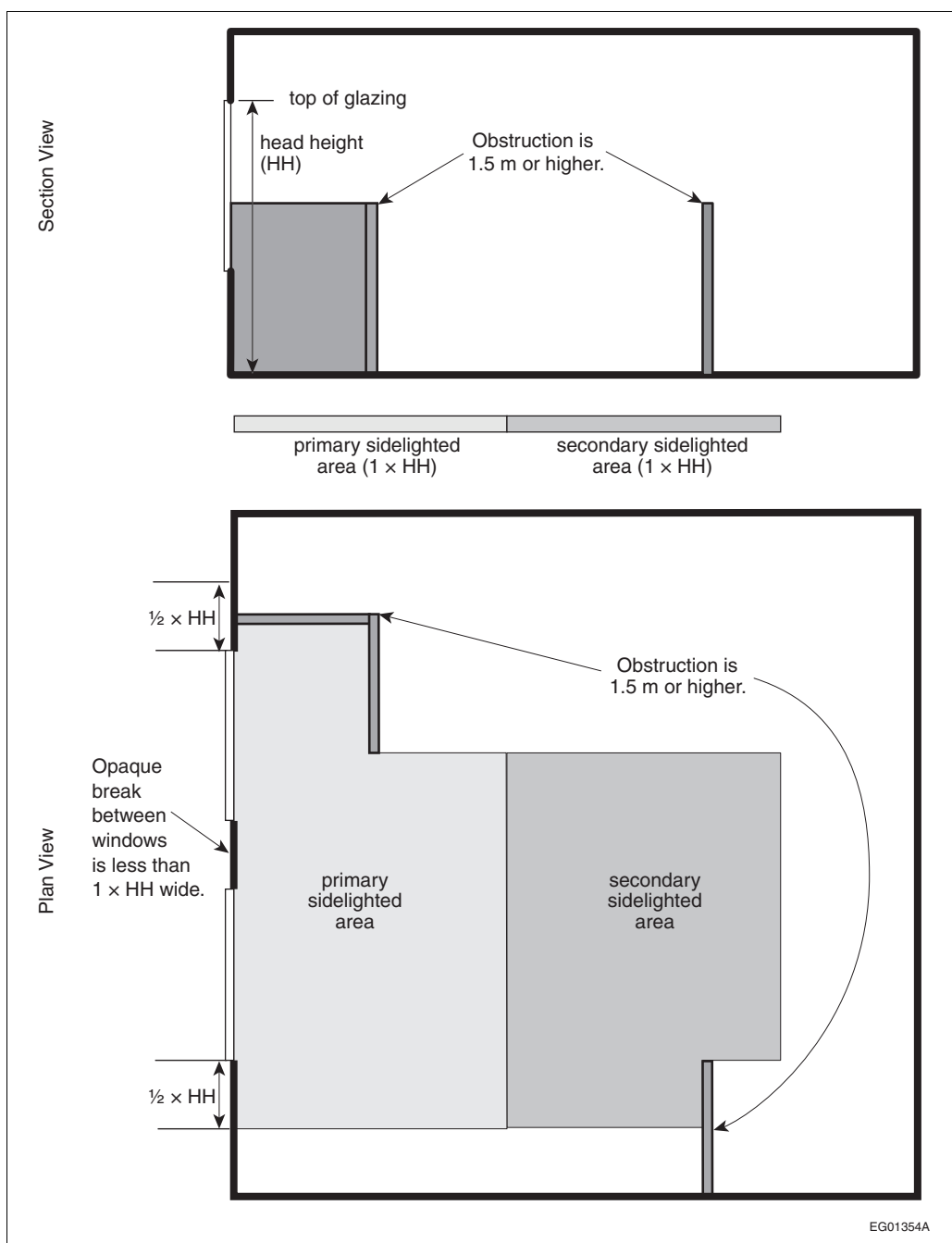

Figure A-4.2.2.3-B
Determining secondary sidelighted areas

A-4.2.2.3.(1) and (5) Double-counting Primary or Secondary Sidelighted Areas. To avoid double-counting overlapping primary or secondary sidelighted areas,

- daylighting contribution to an area can only be counted once either from sidelighting or toplighting, and
- overlapping areas can be included in one primary or secondary sidelighted area only.

A-4.2.2.4. Roof Monitors. A roof monitor is fenestration with glazing more or less in the vertical plane that is part of a rooftop architectural structure.

A-4.2.2.4.(1) and 4.2.2.5.(1) Double-counting Toplighted Areas. To avoid double-counting overlapping tolighted areas,

- daylighting contribution to an area can only be counted once either from sidelighting or toplighting, and
- overlapping tolighted areas can be included in one tolighted area only.

A-4.2.2.4.(2) Daylighted Area Under Roof Monitors. Figure A-4.2.2.4.(2) illustrates how to determine daylighted areas under roof monitors.

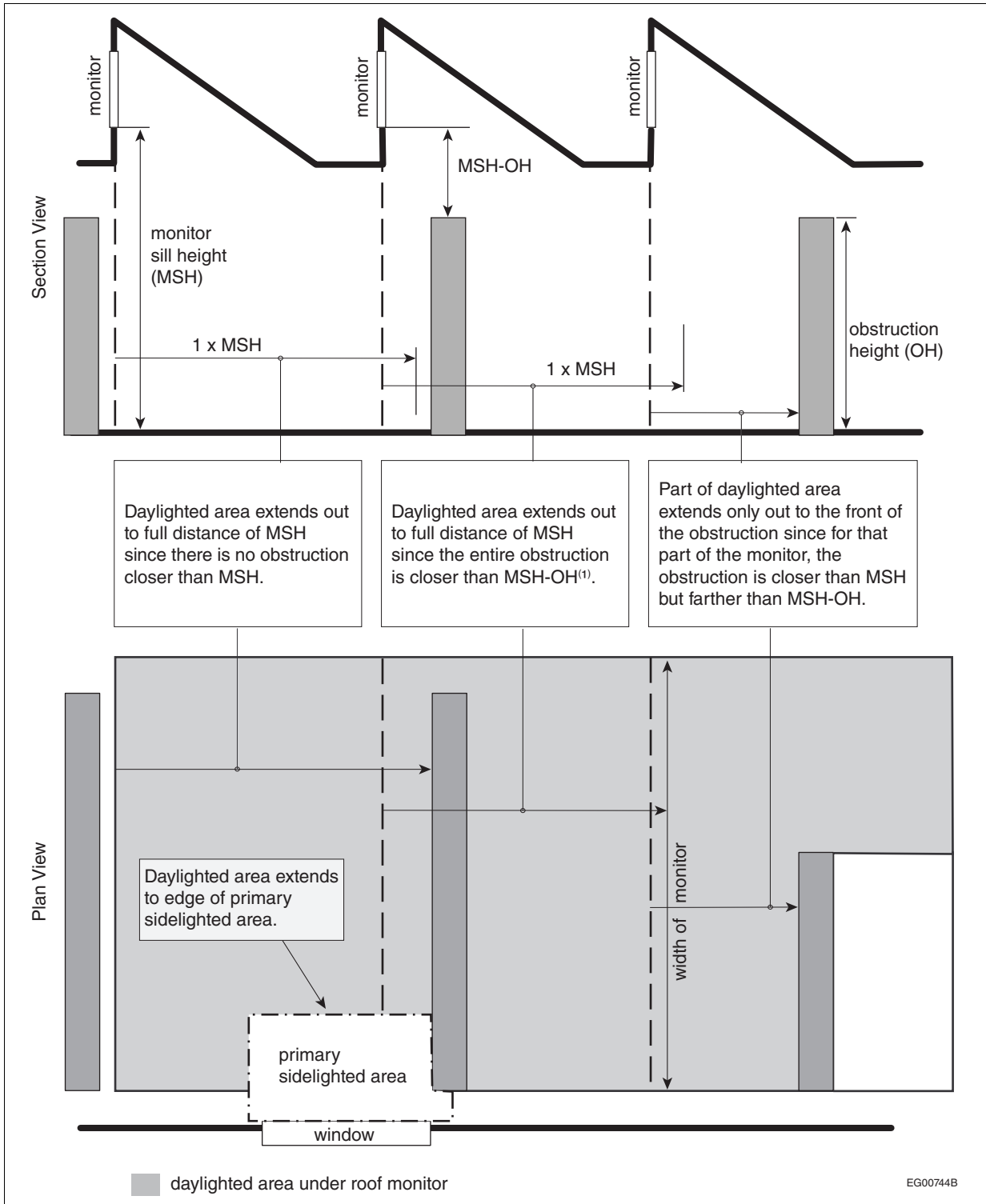

Figure A-4.2.2.4.(2)
Determining daylighted areas under roof monitors

Note to Figure A-4.2.2.4.(2):

- (1) If an obstruction is closer to the roof monitor than MSH-OH, it will not substantially alter the daylight penetration and thus the daylighted area will extend the full MSH.

A-4.2.2.5.(2) Daylighted Area Under Skylights. Figure A-4.2.2.5.(2) illustrates how to determine the daylighted area under skylights.

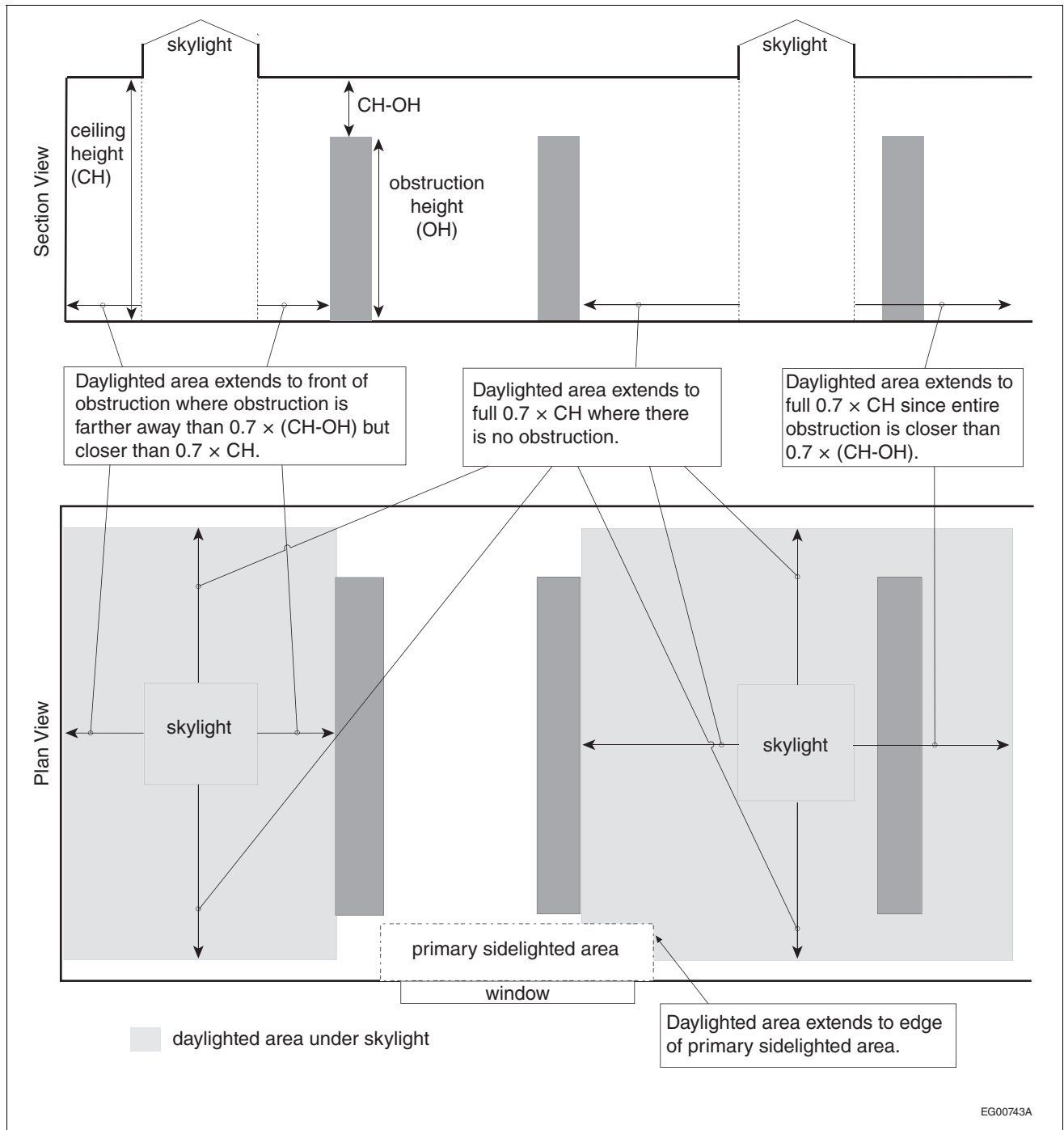

Figure A-4.2.2.5.(2)
Determining daylighted area under skylights

Note to Figure A-4.2.2.5.(2):

- (1) If an obstruction is closer to the skylight than $0.7 \times (CH-OH)$, it will not substantially alter the daylight penetration and thus the daylighted area will extend the full $0.7 \times CH$.

A-4.2.2.6.(2) Lighting Controls in Commercial Temporary Lodgings.**Commercial Temporary Lodgings**

For the purpose of Sentence 4.2.2.6.(2), “commercial temporary lodgings” refers to hotels, motels and other similar buildings.

Lighting Controls

For safety reasons, controls installed to meet the requirement of Sentence 4.2.2.6.(2) must not shut off lighting while occupants are in the suite.

Switched Receptacles

For the purpose of Sentence 4.2.2.6.(2), “switched receptacle” refers to a duplex receptacle used for lighting where at least one outlet is controlled by a wall switch.

A-4.2.3.1.(3) Lighting Power Allowances for Specific Building Exterior Applications. The lighting power allowance for each specific exterior application listed in Table 4.2.3.1.-C is non-transferable: no trading of allowances with other lighting applications is permitted (in other words, “use it or lose it”). Some or all of the basic site allowance may be applied to the specific lighting applications.

A-4.2.3.1.(4) Lighting Power Allowances for General Building Exterior Applications. The lighting power allowance for each general building exterior application plus the portion of the basic site allowance that remains unused following the application of Sentence 4.2.3.1.(3) may be shared among the applications listed in Table 4.2.3.1.-D.

A-4.2.3.1.(5) Lighting Power Allowances for Building Exterior Applications Not Covered in Sentence 4.2.3.1.(4). The lighting power allowance for each building exterior application not covered in Sentence 4.2.3.1.(4) plus the portion of the basic site allowance that remains unused following the application of Sentence 4.2.3.1.(3) may be shared among other applications not covered in Sentence 4.2.3.1.(4).

A-4.3.2.3.(2) Daylighted Area. If the space is illuminated by sidelighting and toplighting, only the dominant daylight supply should be used in the trade-off calculations.

Further, Table 4.3.2.8. provides daylight supply factors for the four cardinal directions only. If a daylighting source does not face an exact cardinal direction, the closest cardinal direction should be used in the trade-off calculations; if the daylighting source faces a direction that is exactly halfway between two cardinal directions (e.g. a wall facing exactly south-east, which is equally close to the south and the east), the most advantageous direction for the purpose of the trade-off calculations can be chosen.

A-4.3.2.7.(4) Daylight System. “Daylight system” refers to building elements that affect the supply of daylight to a building’s interior. Examples of daylight systems are interior shading systems, which reduce daylight availability through a window but improve occupant comfort by reducing glare and allowing control over solar gain, or light shelves and other daylight capture and redirection devices that can enhance daylight supply. The trade-off path for lighting (Subsections 4.3.2. and 4.3.3.) is limited to one type of shading system intended to represent interior venetian blinds, with either manual or automatic (motorized) control, which are considered to be the most commonly used type of shading system.

A-Table 4.3.2.7.-B Daylight-Dependent Control Systems. Table 4.3.2.7.-B lists different control mechanisms that reduce electric lighting usage in a space in response to available daylight. An automatic daylight harvesting system is an example of a daylight-dependent control system: it uses a photosensor to detect the light level in a space and signal a switch or dimming ballast to control electric lighting to maintain a target illumination level. Research shows that, where a manual control is installed, the human eye acts as the photosensor and occupants take it upon themselves to lower electric lighting levels if sufficient daylight is available. However, manual controls are not as effective a means to save energy as automatic ones: as such, the C_{EL} factor is lower for manual controls than for the automatic option. Furthermore, occupants are much more likely to use manual controls if they have sole responsibility for a space than if they share a space: the factor for private enclosed offices is therefore substantially higher than for other space types with manual controls.

A-Table 4.3.2.8. Design Illuminances. Recommendations for design illuminances for various space types can be found in the IES “Lighting Handbook, 10th Edition.” These recommended illuminance levels ensure that visual tasks can be safely performed in a given space. The design illuminance values can be modified from the recommended levels where specific visual tasks require different illuminances.

For design illuminances below 300 lx, the 300 lx values should be used. For design illuminances between the levels listed in Table 4.3.2.8., the raw daylight supply factor can be determined using linear interpolation. For design illuminances above 1 000 lx, the raw daylight supply factor cannot be extrapolated.

A-4.3.3.7.(4) Daylight System Control Factor for the Reference Building. Although many shading system options can be modeled in the reference building, for the purpose of the trade-off path calculations, all spaces in the reference building are considered to have a shading system equivalent to manually-controlled interior blinds, which have a C_{DL} factor of 0.5 according to Table 4.3.2.7.-A.

Division B

Part 5 Heating, Ventilating and Air-conditioning Systems

5.1.	General	
5.1.1.	General	5-1
5.2.	Prescriptive Path	
5.2.1.	Equipment Sizing	5-1
5.2.2.	Air Distribution Systems	5-2
5.2.3.	Fan System Design	5-5
5.2.4.	Air Intake and Outlet Dampers	5-6
5.2.5.	Piping for Heating, Ventilating and Air-conditioning Systems	5-7
5.2.6.	Pumping System Design	5-8
5.2.7.	Equipment Installed Outdoors	5-9
5.2.8.	Temperature Controls	5-9
5.2.9.	Humidification	5-11
5.2.10.	Energy Recovery	5-11
5.2.11.	Shut-off and Setback Controls	5-14
5.2.12.	Equipment Efficiency	5-15
5.3.	Reserved	
5.4.	Performance Path	
5.4.1.	General	5-30
5.5.	Objective and Functional Statements	
5.5.1.	Objective and Functional Statements	5-30
	Notes to Part 5	5-33

Division B

Part 5 Heating, Ventilating and Air-conditioning Systems

Section 5.1. General

5.1.1. General

5.1.1.1. Scope

1) This Part is concerned with the systems used for heating, ventilating and air-conditioning of *buildings* covered by this Code.

5.1.1.2. Application

1) Except as permitted in Sentences (2) and (3), and except for systems and equipment used exclusively for the control of smoke in the event of a fire, this Part applies to heating, ventilating and air-conditioning systems and equipment.

2) A heating, ventilating or air-conditioning system or part thereof may be exempted from some or all of the requirements in this Part where it can be shown that the nature of the *occupancy* or the type of heating, ventilating or air-conditioning equipment used makes it impractical to apply these requirements. (See Note A-5.1.1.2.(2).)

3) This Part does not apply to the existing components of systems that are extended to serve *additions*.

5.1.1.3. Compliance

1) Except as provided in Sentence (2), compliance with this Part shall be achieved by following

- a) the prescriptive path described in Section 5.2., or
- b) the performance path described in Section 5.4. (see Note A-3.1.1.3.(1)(c)).

(See Note A-5.1.1.3.(1).)

2) Back-up systems shall comply with the prescriptive requirements stated in Section 5.2. (See Note A-5.1.1.3.(2).)

5.1.1.4. Definitions

1) Words that appear in italics are defined in Article 1.4.1.2. of Division A.

Section 5.2. Prescriptive Path

5.2.1. Equipment Sizing

5.2.1.1. Load Calculations

1) Heating, ventilating and air-conditioning systems shall be sized in accordance with good engineering practice such as that prescribed in the NBC. (See Note A-5.2.1.1.(1).)

5.2.2.1.

5.2.2. Air Distribution Systems

5.2.2.1. Design and Installation of Ducts

1) Ducts shall be designed and installed in accordance with the NBC. (See Note A-5.2.2.1.(1).)

5.2.2.2. Provision for Balancing

1) All air distribution systems shall be designed so that they can be balanced. (See Note A-5.2.2.2.(1).)

5.2.2.3. Duct Sealing

1) Except as provided in Sentences (2) to (5), air-handling ducts and *plenums* forming part of a heating, ventilating or air-conditioning system shall be constructed, installed and sealed as described in the ANSI/SMACNA 006, "HVAC Duct Construction Standards – Metal and Flexible," and in accordance with Table 5.2.2.3. (See Note A-5.2.2.3.(1).)

2) Air-handling ducts and *plenums* that do not conform to Sentence (1) shall be tested to meet the requirements of Article 5.2.2.4.

3) *Return ducts* located within *conditioned space* or in spaces used as return air *plenums* need not comply with Sentence (1).

4) Except for *supply ducts* located upstream of zone coils, mixing boxes, variable-air-volume boxes and diffusers with integral variable-air-volume controls, *supply ducts* located within the *conditioned space* to which they supply air need not comply with Sentence (1). (See Note A-5.2.2.3.(4).)

5) Sealing tape shall not be used as the primary sealant for air-handling ducts and *plenums*.

Table 5.2.2.3.
Sealing of Ducts
Forming Part of Sentence 5.2.2.3.(1)

Static Pressure Class, Pa ⁽¹⁾	Seal Class ⁽¹⁾
≤ 500	C
> 500 and < 1000	B
≥ 1000	A

Notes to Table 5.2.2.3.:

⁽¹⁾ The Static Pressure and Seal Classes are taken from ANSI/SMACNA 006. The Static Pressure Classes shown do not refer to actual design static pressure and include both negatively and positively pressurized ducts.

5.2.2.4. Leakage Testing of Ducts

1) Where ducts are not constructed, installed and sealed in accordance with Sentence 5.2.2.3.(1), they shall be tested for leakage in conformance with ANSI/SMACNA 016, "HVAC Air Duct Leakage Test Manual," and shall meet the requirements of Sentence (2). (See Note A-5.2.2.4.(1).)

2) For ducts tested in accordance with Sentence (1), the maximum permitted leakage shall be calculated as follows:

$$L_{\max} = C_L \times \left(\frac{P}{249} \right)^{0.65}$$

where

- L_{\max} = maximum permitted leakage, in L/s per m² of duct surface area,
- C_L = leakage class taken from Table 5.2.2.4., in L/s per m², and
- P = maximum operating static pressure, in Pa.

Table 5.2.2.4.
Leakage Classes, C_L
Forming Part of Sentence 5.2.2.4.(2)

Shape of Duct	Maximum Operating Static Pressure, Pa		
	< 500	500–1000	> 1000
	C _L , L/s per m ²		
Rectangular	0.81	0.41	0.20
Round	0.41	0.20	0.10

5.2.2.5. Duct and Plenum Insulation

1) Except as provided in Sentences (3) to (7), all air-handling ducts, *plenums* and run-outs forming part of a heating, ventilating, or air-conditioning system shall be thermally insulated in accordance with Table 5.2.2.5.

2) The insulation thickness used to determine compliance with Table 5.2.2.5. shall be the thickness of the insulation after installation. (See Note A-5.2.2.5.(2), 5.2.5.3.(8) and 6.2.3.1.(6).)

Table 5.2.2.5.
Insulation of Ducts
Forming Part of Sentences 5.2.2.5.(1) and (2)

Temperature Difference, ⁽¹⁾ °C	Minimum Thermal Resistance of Ducts and <i>Plenums</i> , m ² ×°C/W	Minimum Thermal Resistance of Run-outs, ⁽²⁾ m ² ×°C/W
< 5	0	0
5 to 22	0.58	0.58
> 22	0.88	0.58

Notes to Table 5.2.2.5.:

- (1) Refers to the temperature difference at design conditions between the space within which the duct is located and the design temperature of the air carried by the duct. Where a duct is used for both heating and cooling purposes, the larger temperature difference shall be used.
- (2) Refers to ducts not exceeding 3 m in length that connect to terminal grilles or diffusers.

3) *Exhaust ducts, return ducts* and *plenums* located within *conditioned space* need not comply with Sentence (1).

4) *Supply ducts* and *plenums* located within the *conditioned space* they serve need not comply with Sentence (1). (See Note A-5.2.2.5.(4).)

5) Ducts and *plenums* located within *conditioned space* in a *dwelling unit* and serving only that *dwelling unit* need not comply with Sentence (1).

6) Except for relief and outside air ducts and except as provided in Sentence (7), all air-handling ducts and *plenums* forming part of a heating, ventilating or air-conditioning system that are located outside the *building envelope* shall be insulated to the same level as required for walls in Subsection 3.2.2.

7) Factory-installed *plenums* and ducts provided as part of equipment tested and rated in accordance with Article 5.2.12.1. need not comply with Sentences (1) and (6), provided they are insulated to a thermal resistance not less than 0.58 m²×°C/W.

8) Insulation material required in Sentence (1) shall be installed in accordance with good practice. (See Note A-5.2.2.5.(8) and 5.2.5.3.(7).)

9) Manufactured insulation thicknesses shall not be altered.

5.2.2.6.**5.2.2.6. Protection of Duct Insulation**

- 1) Insulation on cold-air *supply ducts* shall be provided with vapour barrier protection to prevent condensation, where the surface temperature of the duct is below the dew point of the air surrounding the duct.
- 2) Duct insulation installed in areas where it may be subject to mechanical damage or weathering shall be protected.

5.2.2.7. Cooling with Outdoor Air

- 1) Except for HVAC systems serving only *dwelling units* or hotel or motel rooms, each system that incorporates mechanical cooling and has an air-handling capacity of more than 1 500 L/s or a cooling capacity of more than 20 kW shall be designed to use outdoor air to reduce mechanical cooling energy by one of the means covered in Articles 5.2.2.8. and 5.2.2.9.

5.2.2.8. Cooling by Direct Use of Outdoor Air (Air Economizer System)

- 1) HVAC systems that use less mechanical cooling energy by direct use of outdoor air shall be capable of mixing return air with up to 100% outdoor air to produce the temperature required to condition the space.
- 2) Systems described in Sentence (1) shall be designed to automatically revert to the minimum outdoor airflow required for acceptable indoor air quality as prescribed by the NBC, when either the return air temperature is less than the outdoor air temperature or the return air enthalpy is less than the outdoor air enthalpy. (See Note A-5.2.2.8.(2).)
- 3) Except as provided in Sentence (6), systems described in Sentence (1) shall be designed to mix outdoor air and return air to a temperature as near as possible to that required to condition the space, even when mechanical cooling is provided.
- 4) Systems described in Sentence (1) with cooling capacities of 70 kW or more shall incorporate cooling equipment that can operate at less than full capacity, with the lowest stage providing no more than 25% of the full capacity of each system.
- 5) Systems described in Sentence (1) with cooling capacities of more than 25 kW but less than 70 kW shall incorporate cooling equipment that can operate at less than full capacity, with the lowest stage providing no more than 50% of the full capacity of each system.
- 6) Direct expansion HVAC systems are permitted to include controls to reduce the quantity of outdoor air at the lowest stage of cooling equipment output as necessary to permit proper operation of the equipment. (See Note A-5.2.2.8.(6).)

5.2.2.9. Cooling by Indirect Use of Outdoor Air (Water Economizer System)

- 1) HVAC systems that reduce mechanical cooling energy use by using outdoor air to chill cooling distribution fluid by direct evaporation, indirect evaporation, or both, shall be capable of cooling supply air so as to provide 100% of the cooling load when the outdoor air wet-bulb temperature is 7°C or lower.
- 2) HVAC systems that reduce mechanical cooling energy use by using outdoor air to chill cooling distribution fluid by sensible heat transfer shall be capable of cooling supply air so as to provide 100% of the cooling load when the outdoor-air dry-bulb temperature is 10°C or lower.

5.2.3. Fan System Design**5.2.3.1. Application**

- 1)** Except for equipment covered by Article 5.2.12.1. and whose minimum performance includes fan energy, this Subsection applies to all fan systems
 - a) that are used for comfort heating, ventilating or air-conditioning, or any combination thereof, and
 - b) for which the total of all fan motor nameplate ratings is 10 kW or more (see Note A-5.2.3.1.(2)).
- 2)** For the purposes of this Subsection, the power demand of a fan system shall be the sum of the demand of all fans required to operate at design conditions to supply air to the *conditioned space*. (See Note A-5.2.3.1.(2).)

5.2.3.2. Constant-Volume Fan Systems

- 1)** Where fans produce a constant airflow rate whenever the system is operating, the power demand required by the motors for the combined supply and return fan system at design conditions shall not exceed 1.6 W per L/s of supply air delivered to the *conditioned space*, calculated using the following equation:

$$W = 0.001 \times F \times SP / \eta$$

where

- W = power demand, in watts,
- F = design flow rate, in L/s,
- SP = design static pressure across the fan, in Pa, and
- η = combined fan-drive-motor efficiency, expressed as a decimal fraction.

(See Note A-5.2.3.2.(1).)

5.2.3.3. Variable-Air-Volume Fan Systems

- 1)** For fan systems through which airflow varies automatically as a function of load, the power demand required by the motors for the combined supply and return fan system, as calculated using the equation in Sentence 5.2.3.2.(1), shall not exceed 2.65 W per L/s of supply air delivered to the *conditioned space* at design conditions. (See Note A-5.2.3.3.(1).)
- 2)** In variable-air-volume systems, any individual supply, relief or return fan with a power demand greater than 7.5 kW and less than 25 kW, as calculated using the equation in Sentence 5.2.3.2.(1), shall incorporate controls and devices such that, if air delivery volume is reduced to 50% of design air volume, the corresponding fan power demand will be no more than 55% of design wattage, based on the manufacturer's test data.
- 3)** In variable-air-volume systems, any individual supply, relief or return fan with a power demand equal to or greater than 25 kW, as calculated using the equation in Sentence 5.2.3.2.(1), shall incorporate controls and devices necessary to prevent the fan motor from demanding more than 30% of design wattage at 50% of design air volume, based on the manufacturer's test data.

5.2.3.4. Demand Control Ventilation Systems

- 1)** Enclosed semi-heated spaces or *conditioned spaces* where fuel-powered vehicles or mobile fuel-powered equipment or appliances are intermittently used shall be provided with sensors and demand control ventilation systems capable of limiting the expected air contaminants to acceptable levels by
 - a) staging the ventilation fans, or
 - b) modulating the outdoor airflow rates.
 (See Note A-5.2.3.4.(1).)
- 2)** Commercial kitchen ventilation systems whose design exhaust fan airflow rate meets or exceeds the values shown in Table 5.2.3.4. for the applicable heating-degree

day category shall be equipped with a demand control ventilation system, including necessary sensors and controls, that is capable of reducing the design exhaust and make-up airflow rates by at least 50% in response to appliance operation. (See Note A-5.2.3.4.(2).)

Table 5.2.3.4.
Demand Control Ventilation Threshold for Commercial Kitchen Ventilation Systems
Forming Part of Sentence 5.2.3.4.(2)

Heating Degree-Days of <i>Building</i> Location, ⁽¹⁾ in Celsius Degree-Days					
Zone 4: ⁽²⁾ < 3000	Zone 5: ⁽²⁾ 3000 to 3999	Zone 6: ⁽²⁾ 4000 to 4999	Zone 7A: ⁽²⁾ 5000 to 5999	Zone 7B: ⁽²⁾ 6000 to 6999	Zone 8: ⁽²⁾ ≥ 7000
Design Exhaust Fan Airflow Rate, L/s					
≥ 2360	≥ 2360	≥ 1880	≥ 1410	≥ 1410	≥ 1410

Notes to Table 5.2.3.4.:

(1) See Sentence 1.1.4.1.(1).

(2) See Note A-Table 3.2.2.2.

5.2.4. Air Intake and Outlet Dampers

5.2.4.1. Required Dampers

- 1)** Except as provided in Sentences (2) to (4), every duct or opening intended to discharge air from a *conditioned space* to the outdoors or to unconditioned space, and every outdoor air intake duct or opening shall be equipped with a motorized damper.
- 2)** Where dampers are not permitted by other regulations, air intakes and outlets need not comply with Sentence (1).
- 3)** Air intakes and outlets serving HVAC systems required to operate continuously need not comply with Sentence (1).
- 4)** Where the duct or opening does not exceed 0.08 m² in cross-sectional area, air intake dampers required by Sentence (1) are permitted to be manually operated and air outlet dampers required by Sentence (1) are permitted to consist of gravity- or spring-operated backflow dampers.

5.2.4.2. Type and Location of Dampers

- 1)** Except as provided in Sentences (3) and (4), dampers required by Article 5.2.4.1. shall be
 - a) located as near as possible to the plane of the *building envelope*, and
 - b) designed to close automatically when the HVAC system is not in operation.
- 2)** Motorized dampers required in Sentence 5.2.4.1.(1) shall be designed so that, when the damper is in the closed position, airflow does not exceed 15 L/s per m² of cross-sectional area at a pressure differential of 250 Pa, when tested in accordance with
 - a) ANSI/AMCA 500-D, "Methods of Testing Dampers for Rating," and
 - b) ANSI/AMCA 500-L, "Methods of Testing Louvers for Rating."
- 3)** Dampers required in Article 5.2.4.1. are permitted to be located inboard of the *building envelope*, provided the portion of the duct between the damper and the *building envelope* is insulated in conformance with Sentence 5.2.2.5.(6) for ducts located outdoors.
- 4)** Dampers in air intakes and outlets serving air-heating or -cooling equipment located outside of the *building envelope* are permitted to be located within the equipment.

5.2.5. Piping for Heating, Ventilating and Air-conditioning Systems

5.2.5.1. Design and Installation of Piping

- 1) HVAC piping shall be designed and installed in accordance with the NBC.

5.2.5.2. Provision for Balancing

- 1) All hydronic systems shall be designed so that they can be balanced. (See Note A-5.2.5.2.(1).)

5.2.5.3. Piping Insulation

- 1) Except as provided in Sentences (2) to (4), piping forming part of an HVAC system shall be thermally insulated in accordance with Table 5.2.5.3. (See Note A-5.2.5.3.(1).)
- 2) Except for suction-line piping of direct expansion systems, piping located within *conditioned space* in a *dwelling unit* and serving only that *dwelling unit* need not comply with Sentence (1).
- 3) HVAC piping that conveys fluids with design operating temperatures greater than 16°C and less than 41°C need not comply with Table 5.2.5.3., if it is located within a *conditioned space*.
- 4) Where piping insulation has a thermal conductivity that is greater than the ranges given in Table 5.2.5.3., the insulation thickness given in the Table shall be increased by the ratio u_2/u_1 , where u_1 is the value at the higher end of the conductivity range for the operating temperature and u_2 is the measured thermal conductivity of the insulation at the mean rating temperature.
- 5) Where piping insulation has a thermal conductivity that is lower than the ranges given in Table 5.2.5.3., the insulation thickness given in the Table may be decreased by the ratio u_2/u_1 , where u_1 is the value at lower end of the conductivity range for the operating temperature and u_2 is the measured thermal conductivity of the insulation at the mean rating temperature.
- 6) The thermal conductivity of piping insulation at a mean rating temperature shall be determined in conformance with ASTM C335/C335M, "Standard Test Method for Steady-State Heat Transfer Properties of Pipe Insulation."
- 7) Insulation material required in Sentence (1) shall be installed in accordance with good practice. (See Note A-5.2.2.5.(8) and 5.2.5.3.(7).)
- 8) The insulation thickness used to determine compliance with Table 5.2.5.3. shall be the thickness of the insulation after installation. (See Note A-5.2.2.5.(2), 5.2.5.3.(8) and 6.2.3.1.(6).)
- 9) Manufactured insulation thicknesses shall not be altered.

Table 5.2.5.3.
Minimum Thickness of Piping Insulation
 Forming Part of Sentences 5.2.5.3.(1), (3) to (5), and (8)

Type of System	Design Operating Temperature Range, °C	Thermal Conductivity of Insulation		Nominal Pipe Diameter, mm (inches)				
		Conductivity Range, W/m×°C	Mean Rating Temperature, °C	Runouts ⁽¹⁾ ≤ 51 (2)	≤ 25.4 (1)	32 to 51 (1¼ to 2)	64 to 102 (2½ to 4)	≥ 127 (5)
				Minimum Thickness of Piping Insulation, mm				
Heating Systems (Steam, Steam Condensate and Hot Water)	> 177	0.046–0.049	121	38.1	114	127	127	127
	122–177	0.042–0.045	93	38.1	76.2	101.6	114	114
	94–121	0.039–0.043	65	38.1	63.5	63.5	76.2	76.2
	61–93	0.036–0.042	52	25.4	38.1	50.8	50.8	50.8
	41–60	0.035–0.040	38	25.4	25.4	38.1	38.1	38.1
Cooling Systems (Chilled Water, Brine and Refrigerant)	4–16	0.030–0.039	24	25.4	25.4	25.4	25.4	25.4
	< 4	0.030–0.039	24	25.4	25.4	38.1	38.1	38.1

Notes to Table 5.2.5.3.:

(1) Refers to runouts to individual terminal units not exceeding 3.7 m in length.

5.2.5.4. Protection of Piping Insulation

1) Insulation on piping conveying chilled fluid shall be provided with vapour barrier protection to prevent condensation, where the surface temperature of the pipe is below the dew point of the air.

2) Piping insulation installed in areas where it may be subject to mechanical damage or weathering shall be protected.

5.2.6. Pumping System Design

5.2.6.1. Application

1) Except as provided in Article 5.2.6.3., this Subsection applies to HVAC pumping systems with a total pump system motor nameplate power of 7.5 kW or greater determined in accordance with Sentence (2).

2) For the purposes of this Subsection, the total pump system motor nameplate power shall be the sum of the nameplate power of all pumps required to operate at design conditions to supply thermal energy to an HVAC system, equipment or appliance, or to a *conditioned space*.

5.2.6.2. Variable-Flow Pumping Systems

1) Except as provided in Sentence (2), HVAC pumping systems that serve control valves designed to modulate or to open and close in steps as a function of load shall be

- designed for variable fluid flow, and
- capable of reducing system flow to 50% or less of design flow.

(See Note A-5.2.6.2.(1).)

2) Sentence (1) does not apply to systems

- in which a minimum flow greater than 50% of the design flow is required for the proper operation of primary equipment serving the system, such as chillers and *boilers*,
- with a single control valve, or
- that include controls to reset the fluid supply temperature based on either outdoor temperature or system loads.

5.2.6.3. Pumping Power Demand

1) The combined pumping power demand required by the motors of all the pumps in a given hydronic system shall not exceed the values stated in Table 5.2.6.3. for the applicable system.

Table 5.2.6.3.
Maximum Pumping Power Demand of Pump Motors
 Forming Part of Sentence 5.2.6.3.(1)

Type of Hydronic System	Maximum Combined Pumping Power Demand of Pump Motors, $W_{\text{motorpower}}/kW_{\text{thermalpeak}}^{(1)}$
Heating	4.5
Heat rejection	12
Cooling	14
Water-source heat pump	22

Notes to Table 5.2.6.3.:

- (1) $W_{\text{motorpower}}$ = combined power of the pump motors
 $kW_{\text{thermalpeak}}$ = peak thermal demand of the loop at design conditions

5.2.7. Equipment Installed Outdoors

5.2.7.1. Manufacturer's Designation

1) Equipment installed outdoors or in an unconditioned space shall be designated by the manufacturer for such installation.

5.2.8. Temperature Controls

5.2.8.1. Temperature Controls

1) Each heating, ventilating or air-conditioning system intended to provide comfort heating or cooling shall include at least one automatic space temperature control device that is accurate to within 1°C.

2) Each *dwelling unit* shall be controlled by at least one thermostatic control device.

5.2.8.2. Temperature Control within Dwelling Units

1) *Dwelling units* shall be provided with manually operated or automatic devices as a means to reduce the heating of each room, as appropriate for the heating system used.

2) Where *dwelling units* are provided with a mechanical cooling system, they shall be provided with manually operated or automatic devices as a means to reduce the cooling of each room, as appropriate for the cooling system used.

5.2.8.3. Temperature Control in Guest Rooms and Suites in Commercial Temporary Lodgings

1) The space temperature in each guest room and *suite* in a commercial temporary lodging shall be controlled so that it is automatically adjusted to a set-back temperature within 15 min of the space being unoccupied. (See Note A-5.2.8.3.(1).)

5.2.8.4. Installation of Thermostats

1) Except as otherwise stated in the manufacturer's instructions and as required in barrier-free installations and for stratified ventilation, sensors for wall-mounted thermostats shall be installed

- a) between 1 400 mm and 1 500 mm above the floor,
- b) on interior *partitions* or walls, or on exterior walls with a maximum *overall thermal transmittance* of 0.286 W/(m²×K),

5.2.8.5.

- c) away from direct exposure to sunlight and heat-producing sources, and
 - d) away from drafts and dead pockets of air.
- (See Note A-5.2.8.4.(1).)

5.2.8.5. Heat Pump Controls

1) Heat pumps equipped with supplementary heaters shall incorporate controls to prevent supplementary heater operation when the heating load can be met by the heat pump alone, except during defrost cycles. (See Note A-5.2.8.5.(1) and 5.2.11.1.(2)(e).)

5.2.8.6. Space Temperature Control

1) Except as provided in Sentence (2), the supply of heating and cooling energy to a zone shall be controlled by individual thermostatic controls responding to temperature within the zone.

2) An independent perimeter heating and cooling system designed to offset only *building envelope* heat losses or gains, or both, is permitted to be used, provided

- a) it includes at least one thermostatic control for each *building* exposure having exterior walls facing only one orientation for an uninterrupted distance of 15 m or more (see Note A-5.2.8.6.(2)(a)), and
- b) its heating and cooling energy supply is controlled by thermostat(s) located within the zone(s) it serves.

3) Where separate thermostatic controls are provided to control heating and cooling to a space, means shall be provided to prevent these controls from simultaneously calling for heating and cooling. (See Note A-5.2.8.6.(3).)

4) Thermostats installed to control electric resistance heater units shall conform to CAN/CSA-C828, "Performance requirements for line voltage thermostats used with individual room electric space heating devices."

5) Vestibules between *conditioned spaces* and the outdoors shall have a temperature-control device that limits the maximum heating temperature in the vestibule to 15°C.

5.2.8.7. Ice- and Snow-Melting Heater Controls

1) Ice- and snow-melting heaters shall be provided with automatic controls or readily accessible manual controls that allow them to be shut down when not required.

5.2.8.8. Control of Temperature of Air Leaving the Supply Air Handler

1) Except as provided in Sentences (2) and (3), a *supply air handler* shall be designed and equipped with controls to achieve the design supply air temperature without

- a) heating previously cooled air,
- b) cooling previously heated air, or
- c) heating outdoor air, separately from the return air or mixed with it, in excess of the minimum required for ventilation.

2) Reheating supply air for humidity control is permitted where specified humidity levels are required. (See Note A-5.2.8.8.(2).)

3) Reheating supply air is permitted where such reheating will not cause an increase in energy consumption.

5.2.8.9. Control of Space Temperature by Reheating or Recooling

1) Except as provided in Sentence (4), HVAC systems that control the temperature of a space by reheating previously cooled air shall be equipped with controls that automatically adjust the temperature of the cool air supply to the highest temperature that will satisfy the *temperature-control zone* requiring the coolest air.

2) Except as provided in Sentence (4), HVAC systems that control the temperature of a space by recooling previously heated air shall be equipped with controls that automatically adjust the temperature of the warm air supply to the lowest temperature that will satisfy the *temperature-control zone* requiring the warmest air.

3) Except as provided in Sentence (4), HVAC systems that control the temperature of a space by mixing heated supply air and cooled supply air shall be equipped with controls that

- a) automatically adjust the temperature of the warm supply air to the lowest temperature that will satisfy the *temperature-control zone* requiring the warmest air, and
- b) automatically adjust the temperature of the cool supply air to the highest temperature that will satisfy the *temperature-control zone* requiring the coolest air.

4) HVAC systems need not comply with Sentences (1) to (3) if they are designed to reduce the supply airflow rate to each *temperature-control zone* to the greater of

- a) 30% of the design airflow rate, and
- b) the airflow rate required to comply with the ventilation requirements for that zone.

(See Note A-5.2.8.9.(4).)

5.2.9. Humidification

5.2.9.1. Humidification Controls

1) If an HVAC system is equipped with a means for adding or removing moisture to maintain specific humidity levels in a space, an automatic humidity control device shall be provided.

5.2.10. Energy Recovery

5.2.10.1. Energy Recovery Systems

1) Except as provided in Sentence (3), where an exhaust air system’s design supply fan airflow rate meets or exceeds the applicable values listed in Table 5.2.10.1.-A or 5.2.10.1.-B, which depend on the ventilation system’s continuous or non-continuous operation and the percentage of outdoor air it uses at design airflow conditions, as well as the climate zone of the *building* location, it shall be equipped with an energy recovery system. (See Note A-5.2.10.1.(1).)

Table 5.2.10.1.-A
Supply Fan Airflow Rate Threshold Values at which an Energy Recovery System is Required for the Exhaust Air System:
NON-CONTINUOUSLY OPERATING VENTILATION SYSTEMS⁽¹⁾
 Forming Part of Sentence 5.2.10.1.(1)

Heating Degree-Days of <i>Building Location</i> , ⁽²⁾ in Celsius Degree-Days	Percentage of Outdoor Air at Design Airflow Conditions							
	≥ 10% and < 20%	≥ 20% and < 30%	≥ 30% and < 40%	≥ 40% and < 50%	≥ 50% and < 60%	≥ 60% and < 70%	≥ 70% and < 80%	≥ 80%
	Design Supply Fan Airflow Rate Threshold Values, ⁽³⁾ L/s (ft. ³ /min)							
Zone 4: ⁽⁴⁾ < 3000	NR	NR	NR	NR	NR	NR	NR	NR
Zone 5: ⁽⁴⁾ 3000 to 3999	≥ 12 270 (25 999)	≥ 7 550 (15 998)	≥ 2 600 (5 509)	≥ 2 120 (4 492)	≥ 1 650 (3 496)	≥ 940 (1 992)	≥ 470 (996)	R
Zone 6: ⁽⁴⁾ 4000 to 4999	≥ 12 270 (25 999)	≥ 7 550 (15 998)	≥ 2 600 (5 509)	≥ 2 120 (4 492)	≥ 1 650 (3 496)	≥ 940 (1 992)	≥ 470 (996)	R
Zones 7A and 7B: ⁽⁴⁾ 5000 to 6999	≥ 2 120 (4 492)	≥ 1 890 (4 005)	≥ 1 180 (2 500)	≥ 470 (996)	R	R	R	R
Zone 8: ⁽⁴⁾ ≥ 7000	≥ 2 120 (4 492)	≥ 1 890 (4 005)	≥ 1 180 (2 500)	≥ 470 (996)	R	R	R	R

Notes to Table 5.2.10.1.-A:

(1) Ventilation systems that operate less than 8 000 hours per year are considered “non-continuously operating.”

Table 5.2.10.1-A (Continued)

- (2) See Sentence 1.1.4.1.(1).
- (3) The abbreviations that appear in this Table have the following meanings:
 NR = energy recovery system is not required at any design supply fan airflow rate
 R = energy recovery system is required at all design supply fan airflow rates
- (4) See Note A-Table 3.2.2.2.

Table 5.2.10.1-B

**Supply Fan Airflow Rate Threshold Values at which an Energy Recovery System is Required for the Exhaust Air System:
 CONTINUOUSLY OPERATING VENTILATION SYSTEMS⁽¹⁾**

Forming Part of Sentence 5.2.10.1.(1)

Heating Degree-Days of Building Location, ⁽²⁾ in Celsius Degree-Days	Percentage of Outdoor Air at Design Airflow Conditions							
	≥ 10% and < 20%	≥ 20% and < 30%	≥ 30% and < 40%	≥ 40% and < 50%	≥ 50% and < 60%	≥ 60% and < 70%	≥ 70% and < 80%	≥ 80%
	Design Supply Fan Airflow Rate Threshold Values, ⁽³⁾ L/s (ft. ³ /min)							
Zone 4: ⁽⁴⁾ < 3000	NR	≥ 9 200 (19 494)	≥ 4 250 (9 005)	≥ 2 360 (5 001)	≥ 1 890 (4 005)	≥ 1 420 (3 009)	≥ 710 (1 504)	R
All other zones: ⁽⁴⁾ ≥ 3000	R	R	R	R	R	R	R	R

Notes to Table 5.2.10.1-B:

- (1) Ventilation systems that operate 8 000 hours or more per year are considered “continuously operating.”
- (2) See Sentence 1.1.4.1.(1).
- (3) The abbreviations that appear in this Table have the following meanings:
 NR = energy recovery system is not required at any design supply fan airflow rate
 R = energy recovery system is required at all design supply fan airflow rates.
- (4) See Note A-Table 3.2.2.2.

2) Heat recovered in accordance with Sentence (1) shall be used in *building* systems.

3) Specialized exhaust systems, such as those used to exhaust smoke, grease-laden vapours, toxic flammable paint or corrosive fumes or dust, need not comply with Sentence (1).

4) Energy recovery systems required by Sentence (1) shall have at least 50% energy recovery effectiveness, *E*, determined as a change in the enthalpy of the outdoor air supply equal to 50% of the difference between the outdoor air and return air enthalpies at design conditions:

$$E = \frac{h_{\text{OA entering}} - h_{\text{OA leaving}}}{h_{\text{OA entering}} - h_{\text{RA}}} \geq 50\%$$

where

- $h_{\text{OA entering}}$ = enthalpy of the outdoor air entering the energy recovery system, kJ/kg dry air (Btu/lb. dry air),
 $h_{\text{OA leaving}}$ = enthalpy of the outdoor air leaving the energy recovery system, kJ/kg dry air (Btu/lb. dry air), and
 h_{RA} = enthalpy of the return air entering the energy recovery system, kJ/kg dry air (Btu/lb. dry air).

(See Note A-5.2.10.1.(4).)

5) At airflow rates not less than the system design capacity, the energy recovery effectiveness of an energy recovery apparatus referred to in Sentence (1) shall be determined in conformance with the test method described in

- a) AHRI 1061 (SI), "Performance Rating of Air-to-Air Exchangers for Energy Recovery Ventilation Equipment,"
- b) CAN/CSA-C439, "Laboratory methods of test for rating the performance of heat/energy-recovery ventilators," or
- c) ANSI/ASHRAE 84, "Method of Testing Air-to-Air Heat/Energy Exchangers."

6) Energy recovery systems shall include bypass or control measures so their operation does not cause the HVAC system's supply air temperature to overshoot the set-point. (See Note A-5.2.10.1.(6).)

5.2.10.2. Heat Recovery from Dehumidification in Swimming Pools

1) Except for pools with a water surface area of less than 10 m² and except as provided in Sentence (2), systems that exhaust air from swimming pools within *conditioned spaces* shall be capable of recovering at least 40% of the sensible heat from exhaust air at design conditions, as calculated in accordance with Sentence 5.2.10.1.(4). (See Note A-5.2.10.2.(1).)

2) Indoor swimming pools need not comply with Sentence (1), provided a stationary mechanical or desiccant dehumidification system is installed that provides at least 80% of the dehumidification that would result from compliance with Sentence (1).

5.2.10.3. Heat Recovery from Ice-making Machines in Ice Arenas and Curling Rinks

1) Where an ice arena or a curling rink has a heating requirement, the refrigeration system shall incorporate a means of recovering the heat rejected by the system to satisfy some or all of the *building's* space-heating or *service water* heating requirements. (See Note A-5.2.10.3.(1).)

5.2.10.4. Heat Recovery in Dwelling Units

1) Except for climate zones 4, 5 and 6, where a self-contained mechanical ventilation system serves a single *dwelling unit*, the principal exhaust component of the ventilation system shall be equipped with heat-recovery capability. (See Note A-5.2.10.4.(1).)

2) Heat-recovery ventilators used to meet the requirements of Sentence (1) shall have a sensible-heat-recovery efficiency, when tested in conformance with the low-temperature thermal and ventilation test methods described in CAN/CSA-C439, "Laboratory methods of test for rating the performance of heat/energy-recovery ventilators," of

- a) at least 65% at an outside air test temperature of 0°C, and
- b) not less than that required by Table 5.2.10.4. for the 2.5% January design temperature for the *building's* location, as listed in Table C-1.

(See Note A-5.2.10.4.(2).)

Table 5.2.10.4.
Performance of Heat-recovery Ventilators
Forming Part of Sentence 5.2.10.4.(2)

2.5% January Design Temperature at <i>Building</i> Location	Outside Air Test Temperature at Station 1, ⁽¹⁾ °C	Sensible-Heat-Recovery Efficiency, %
≥ -10	0	65
< -10 and > -30	-25	55
≤ -30	-40	45

Notes to Table 5.2.10.4.:

(1) "Station 1" is a term that is defined in CAN/CSA-C439 and means the location where temperature is measured.

3) The tests described in Sentence (2) shall be performed at the rated airflow for continuous operation of the equipment, which meets the principal exhaust component of the ventilation system referred to in Sentence (1).

4) Except as stated in Sentence (5), where a heat-recovery system other than a heat-recovery ventilator is used to meet the requirements of Sentence (1), that system shall have a heat-recovery performance equivalent to that required in Sentence (2) for heat-recovery ventilators.

5) Where heat-recovery systems are required in multi-unit residential *buildings*, the minimum sensible-heat-recovery efficiency shall be 50%. (See Note A-5.2.10.4.(5).)

5.2.11. Shut-off and Setback Controls

5.2.11.1. Off-hours Controls

1) Except as provided in Sentence (3), systems serving *dwelling units* or other areas that are not intended to operate continuously and whose zone-heating or -cooling capacity requirement is 5 kW or more shall be equipped with automatic controls capable of setting back or shutting down the systems during periods of non-use of the zones served. (See Note A-5.2.11.1.(1).)

2) Controls required by Sentence (1) shall be capable of

- a) shutting down fan systems and/or heating and cooling equipment and auxiliaries, where appropriate, when conditioning is not required by the space,
- b) setting back the space-heating temperature setpoint,
- c) setting up the space-cooling temperature setpoint if the cooling system is required to operate during periods when the space is not in use,
- d) reducing or shutting off outdoor air intake during heating or cooling system operation when the space is not in use (see Note A-5.2.11.1.(2)(d)), and
- e) in the case of heat pumps, temporarily suppressing electrical back-up or adaptive anticipation of the recovery point in order to prevent the unit from resorting to supplementary heat at the time of recovery (see Notes A-5.2.11.1.(2)(e) and A-5.2.8.5.(1) and 5.2.11.1.(2)(e)).

3) Zones with a total heating or cooling capacity requirement of less than 5 kW may be controlled by readily accessible manual controls.

4) Controls required by Sentence (1) shall be designed so that lowering a heating thermostat setpoint will not cause energy for cooling to be expended to reach the lowered setting and raising a cooling thermostat setpoint will not cause energy for heating to be expended to reach the raised setting.

5.2.11.2. Airflow Control Areas

1) Except as provided in Sentences (2) and (8), each air distribution system serving multiple *temperature-control zones* having a combined *floor surface area* of *conditioned space* of more than 2 500 m² shall be divided into *airflow control areas* so that the supply and exhaust of air to individual *airflow control areas* can be reduced or stopped independently of other *airflow control areas* served by the system.

2) Where it is impractical to control air distribution as described in Sentence (1), individual air distribution systems shall serve *airflow control areas* no greater than 2 500 m².

3) Each *airflow control area* required by Sentences (1) and (2) shall include only *temperature-control zones* intended to be operated simultaneously. (See Note A-5.2.11.2.(3).)

4) Each *airflow control area* required by Sentences (1) and (2) shall not span more than one *storey*.

5) Each *airflow control area* required by Sentence (1) shall be equipped with controls meeting the requirements of Article 5.2.11.1.

6) The air distribution system shall be designed such that a reduction in air delivery of up to 50% of design flow results in at least a proportional reduction in fan power.

7) Controls and devices such as direct digital control and variable-air-volume systems shall be provided to allow stable operation of all fan systems and associated *primary systems* for any length of time while they are serving a single *airflow control area*.

8) *Temperature-control zones* in which outdoor air and exhaust requirements prevent the reduction or stopping of the air supply need not be incorporated into *airflow control areas*.

5.2.11.3. Seasonal Shutdown

1) HVAC pumping systems that are used on a seasonal basis shall be equipped with

- automatic controls, or
- readily accessible and clearly labeled manual controls that allow them to be shut down when not required.

5.2.11.4. Multiple Boilers

1) HVAC systems with multiple *boilers* shall incorporate a means for preventing heat loss through the *boilers* when they are not operating, such as a device that prevents the flow of heat-carrying fluid through the *boilers* or dampers installed in the flues.

2) Except as provided in Sentence (3), where the heating load exceeds 176 kW, the *boiler* plant shall consist of

- more than one *boiler*,
- a two-stage single *boiler*, or
- a multi-stage *boiler*.

3) Where the heating load exceeds 352 kW, the *boiler* plant shall be fully modulating.

5.2.11.5. Loop Temperature Reset for Chilled- and Hot-Water Systems

1) Except as provided in Sentences (2) and (3), chilled- or hot-water systems with a design capacity greater than 88 kW supplying chilled or heated water to comfort-conditioning systems shall be equipped with automatic controls that reset the supply water loop temperatures

- in relation to the outdoor temperature using an indoor/outdoor controller, or
- in relation to representative *building* heating and cooling loads using the return water temperature in the system.

2) Chilled- and hot-water systems described in Sentence (1) need not be equipped with loop temperature reset controls where such controls would cause the improper operation of heating, cooling, humidifying, or dehumidifying equipment or systems.

3) Chilled- and hot-water systems described in Sentence (1) that are designed with variable-flow pumping complying with Sentence 5.2.6.2.(1) need not be equipped with loop temperature reset controls.

5.2.12. Equipment Efficiency

5.2.12.1. Unitary and Packaged HVAC Equipment

1) Unitary and packaged HVAC equipment and components with the capacities listed in Tables 5.2.12.1.-A to 5.2.12.1.-P shall comply with the performance requirements stated therein. (See Notes A-5.2.12.1.(1) and A-5.2.12.1.(1) and 6.2.2.1.(1).) (See also Article 6.2.2.4.)

Table 5.2.12.1.-A
Performance Requirements for Air-Cooled Unitary Air Conditioners and Heat Pumps – Electrically Operated⁽¹⁾
 Forming Part of Sentences 5.2.12.1.(1), 6.2.2.4.(2), 6.2.2.5.(1) and 8.4.4.18.(6)

Type of Equipment	Cooling or Heating Capacity, kW	Performance Testing Standard	Rating Conditions	Minimum Performance ⁽²⁾		
Single-package, space-constrained	< 19	CSA C656	See standard	SEER = 13 / HSPF V = 6.4 ⁽³⁾		
Single-package, others				SEER = 15 / HSPF V = 7.4 ⁽³⁾		
Split system, space-constrained				SEER = 13 / HSPF V = 6.4 ⁽³⁾		
Split system, others				SEER = 15 / HSPF V = 7.4 ⁽³⁾		
Small-duct, high-velocity				SEER = 13 / HSPF V = 5.9 ⁽³⁾		
Large air conditioners and heat pumps, split and single-package, all electrical phases, in cooling mode	≥ 19 and < 40	CAN/CSA-C746	Electric resistance heating section or no heating section	EER = 11.2 IEER = 12.9		
			Other types of heating sections	EER = 11.0 IEER = 12.7		
	≥ 40 and < 70		Electric resistance heating section or no heating section	EER = 11.0 IEER = 12.4		
			Other types of heating sections	EER = 10.8 IEER = 12.2		
	≥ 70 and < 223		Electric resistance heating section or no heating section	EER = 10.0 IEER = 11.6		
			Other types of heating sections	EER = 9.8 IEER = 11.4		
	≥ 223		ANSI/AHRI 340/360	Electric resistance heating section or no heating section	EER = 9.7 IEER = 11.2	
				Other types of heating sections	EER = 9.5 IEER = 11.0	
	Large heat pumps, split and single-package, all electrical phases, in heating mode		≥ 19 and < 40	CAN/CSA-C746	at 8.3°C	COP _h = 3.30
					at -8.3°C	COP _h = 2.25
≥ 40 and < 70		at 8.3°C	COP _h = 3.20			
		at -8.3°C	COP _h = 2.05			
≥ 70 and < 223		at 8.3°C	COP _h = 3.20			
		at -8.3°C	COP _h = 2.05			
≥ 223		ANSI/AHRI 340/360	at 8.3°C		COP _h = 3.20	
			at -8.3°C		COP _h = 2.05	

Notes to Table 5.2.12.1.-A:

- (1) Components or equipment regulated in the “Energy Efficiency Regulations” at the time of publication of the Code (see Article 1.1.1.3. of Division A).
- (2) The symbols and abbreviations that appear in this column have the following meanings:
 COP_h = coefficient of performance in heating mode, in W/W
 EER = energy-efficiency ratio, in (Btu/h)/W
 HSPF V = heating seasonal performance factor for region V (see map in CSA C656), in (Btu/h)/W
 IEER = integrated energy-efficiency ratio, in (Btu/h)/W
 SEER = seasonal energy-efficiency ratio, in (Btu/h)/W
- (3) SEER applies to air conditioners, and both SEER and HSPF V apply to heat pumps.

Table 5.2.12.1.-B
Performance Requirements for Single-Package Vertical Air Conditioners (SPVAC) and Heat Pumps (SPVHP)⁽¹⁾
 Forming Part of Sentences 5.2.12.1.(1), 6.2.2.4.(2), 6.2.2.5.(1) and 8.4.4.18.(6)

Type of Equipment	Cooling or Heating Capacity, kW	Performance Testing Standard	Rating Conditions	Minimum Performance ⁽²⁾
SPVAC and SPVHP in cooling mode	< 70	CAN/CSA-C746	< 19 kW	EER = 11
			≥ 19 kW and < 40 kW	EER = 10
			≥ 40 kW and < 70 kW	EER = 10
SPVHP in heating mode			< 19 kW	COP _h = 3.3
			≥ 19 kW and < 40 kW	COP _h = 3.0
			≥ 40 kW and < 70 kW	COP _h = 3.0

Notes to Table 5.2.12.1.-B:

- (1) Components or equipment regulated in the “Energy Efficiency Regulations” at the time of publication of the Code (see Article 1.1.1.3. of Division A).
- (2) The symbols and abbreviations that appear in this column have the following meanings:
 COP_h = coefficient of performance in heating mode, in W/W
 EER = energy-efficiency ratio, in (Btu/h)/W

Table 5.2.12.1.-C
Performance Requirements for Water-Cooled and Evaporatively Cooled Unitary Air Conditioners – Electrically Operated
 Forming Part of Sentences 5.2.12.1.(1), 6.2.2.4.(2), 6.2.2.5.(1) and 8.4.4.18.(6)

Type of Equipment	Cooling or Heating Capacity, kW	Performance Testing Standard	Rating Conditions	Minimum Performance ⁽¹⁾
Water-cooled and evaporatively cooled, split and single-package	< 19	ANSI/AHRI 210/240	< 19 kW	EER = 12.1 IEER = 12.3
Water-cooled, split and single-package ⁽²⁾	≥ 19 and < 40	CAN/CSA-C746	Electric resistance heating section or no heating section	EER = 12.1 IEER = 13.9
			Other types of heating sections	EER = 11.9 IEER = 13.7
	≥ 40 and < 70		Electric resistance heating section or no heating section	EER = 12.5 IEER = 13.9
			Other types of heating sections	EER = 12.3 IEER = 13.7
	≥ 70 and < 223		Electric resistance heating section or no heating section	EER = 12.4 IEER = 13.6
			Other types of heating sections	EER = 12.2 IEER = 13.4
Evaporatively cooled, split and single-package ⁽²⁾	≥ 19 and < 40	CAN/CSA-C746	Electric resistance heating section or no heating section	EER = 12.1 IEER = 12.3
			Other types of heating sections	EER = 11.9 IEER = 12.1
	≥ 40 and < 70		Electric resistance heating section or no heating section	EER = 12.0 IEER = 12.2
			Other types of heating sections	EER = 11.8 IEER = 12.0
	≥ 70 and < 223		Electric resistance heating section or no heating section	EER = 11.9 IEER = 12.1
			Other types of heating sections	EER = 11.7 IEER = 11.9

Table 5.2.12.1.-C (Continued)

Type of Equipment	Cooling or Heating Capacity, kW	Performance Testing Standard	Rating Conditions	Minimum Performance ⁽¹⁾
Water-cooled, split and single-package	≥ 223	ANSI/AHRI 340/360	Electric resistance heating section or no heating section	EER = 12.2 IEER = 13.5
			Other types of heating sections	EER = 12.0 IEER = 13.3
Evaporatively cooled, split and single-package			Electric resistance heating section or no heating section	EER = 11.7 IEER = 11.9
			Other types of heating sections	EER = 11.5 IEER = 11.7

Notes to Table 5.2.12.1.-C:

(1) The symbols and abbreviations that appear in this column have the following meanings:

EER = *energy-efficiency ratio*, in (Btu/h)/W

IEER = *integrated energy-efficiency ratio*, in (Btu/h)/W

(2) Components or equipment regulated in the “Energy Efficiency Regulations” at the time of publication of the Code (see Article 1.1.1.3. of Division A.).

Table 5.2.12.1.-D

Performance Requirements for Condensing Units

Forming Part of Sentences 5.2.12.1.(1), 6.2.2.4.(2), 6.2.2.5.(1) and 8.4.4.18.(6)

Type of Equipment	Cooling or Heating Capacity, kW	Performance Testing Standard	Rating Conditions	Minimum Performance ⁽¹⁾
Air-cooled ⁽²⁾	≥ 40 and < 70	CAN/CSA-C746	See standard	EER = 11.2
Water-cooled and evaporatively cooled ⁽²⁾				EER = 13.1
Air-cooled	≥ 70	ANSI/AHRI 366 (SI)	≥ 70 kW	EER = 10.5 IEER = 11.8
Water-cooled and evaporatively cooled				EER = 13.5 IEER = 14.0

Notes to Table 5.2.12.1.-D:

(1) The symbols and abbreviations that appear in this column have the following meanings:

EER = *energy-efficiency ratio*, in (Btu/h)/W

IEER = *integrated energy-efficiency ratio*, in (Btu/h)/W

(2) Components or equipment regulated in the “Energy Efficiency Regulations” at the time of publication of the Code (see Article 1.1.1.3. of Division A.).

Table 5.2.12.1.-E

Performance Requirements for Water-Source Unitary Heat Pumps

Forming Part of Sentences 5.2.12.1.(1), 6.2.2.4.(2), 6.2.2.5.(1) and 8.4.4.18.(6)

Type of Equipment	Cooling or Heating Capacity, kW	Performance Testing Standard	Rating Conditions	Minimum Performance ⁽¹⁾
Water-to-air ⁽²⁾	< 5	CAN/CSA-C13256-1	Water loop	COP _c = 3.58 COP _h = 4.3
	≥ 5 and < 40			COP _c = 3.81 COP _h = 4.3
	< 40		Groundwater	COP _c = 5.28 COP _h = 3.7
			Ground loop	COP _c = 4.13 COP _h = 3.2

Table 5.2.12.1.-E (Continued)

Type of Equipment	Cooling or Heating Capacity, kW	Performance Testing Standard	Rating Conditions	Minimum Performance ⁽¹⁾
Water-to-water	< 40	CAN/CSA-C13256-2	Water loop	COP _c = 3.11 COP _h = 3.7
			Groundwater	COP _c = 5.60 COP _h = 3.4
			Ground loop	COP _c = 4.21 COP _h = 2.8

Notes to Table 5.2.12.1.-E:

- (1) The symbols and abbreviations that appear in this column have the following meanings:
 COP_c = coefficient of performance in cooling mode, in W/W
 COP_h = coefficient of performance in heating mode, in W/W
- (2) Components or equipment regulated in the “Energy Efficiency Regulations” at the time of publication of the Code (see Article 1.1.1.3. of Division A).

Table 5.2.12.1.-F
Performance Requirements for Direct-Expansion Ground-Source Heat Pumps – Electrically Operated
 Forming Part of Sentences 5.2.12.1.(1), 6.2.2.4.(2), 6.2.2.5.(1) and 8.4.4.18.(6)

Type of Equipment	Cooling or Heating Capacity, kW	Performance Testing Standard	Rating Conditions	Minimum Performance ⁽¹⁾
Direct-expansion ground-source heat pumps	≤ 21	CSA C748	See standard	COP _c = 3.81 COP _h = 3.1
	> 21			No requirements

Notes to Table 5.2.12.1.-F:

- (1) The symbols and abbreviations that appear in this column have the following meanings:
 COP_c = coefficient of performance in cooling mode, in W/W
 COP_h = coefficient of performance in heating mode, in W/W

Table 5.2.12.1.-G
Performance Requirements for Packaged Terminal Air Conditioners (PTAC) and Heat Pumps (PTHP), and Room Air Conditioners and Heat Pumps⁽¹⁾
 Forming Part of Sentences 5.2.12.1.(1), 6.2.2.4.(2), 6.2.2.5.(1) and 8.4.4.18.(6)

Type of Equipment	Cooling or Heating Capacity, kW	Performance Testing Standard	Rating Conditions	Minimum Performance ⁽²⁾
PTAC and PTHP in cooling mode, standard and non-standard sizes	< 2.1	AHRI 310/380/CSA C744	See standard	EER = 11.9
	≥ 2.1 and < 4.4			EER = 14.1 – (1.0435 × Cap _{kW})
	≥ 4.4			EER = 9.5
PTHP in heating mode, standard and non-standard sizes	< 2.1			COP _h = 3.3
	≥ 2.1 and < 4.4			COP _h = 3.67 – (0.1739 × Cap _{kW})
	≥ 4.4			COP _h = 2.9

Table 5.2.12.1.-G (Continued)

Type of Equipment	Cooling or Heating Capacity, kW	Performance Testing Standard	Rating Conditions	Minimum Performance ⁽²⁾
Louvered, without reverse cycle	< 5.9	CSA C368.1	See standard	CEER = 10.7
	≥ 5.9 and ≤ 10.6			CEER = 9.0
Louvered, with reverse cycle	< 5.9			CEER = 9.8
	≥ 5.9 and ≤ 10.6			CEER = 9.3
Non-louvered, without reverse cycle	< 4.1			CEER = 9.6
	≥ 4.1 and ≤ 10.6			CEER = 9.4
Non-louvered, with reverse cycle	< 4.1			CEER = 9.3
	≥ 4.1 and ≤ 10.6			CEER = 8.7
Room air conditioners, casement only	All capacities			CEER = 9.5
Room air conditioners, casement slider				CEER = 10.4

Notes to Table 5.2.12.1.-G:

(1) Components or equipment regulated in the “Energy Efficiency Regulations” at the time of publication of the Code (see Article 1.1.1.3. of Division A).

(2) The symbols and abbreviations that appear in this column have the following meanings:

CEER = combined *energy-efficiency ratio*, in (Btu/h)/W

COP_h = *coefficient of performance* in heating mode, in W/W

EER = *energy-efficiency ratio*, in (Btu/h)/W

Table 5.2.12.1.-H
Performance Requirements for Computer Room Air Conditioners
 Forming Part of Sentences 5.2.12.1.(1), 6.2.2.4.(2), 6.2.2.5.(1) and 8.4.4.18.(6)

Type of Equipment	Cooling or Heating Capacity, kW	Performance Testing Standard	Rating Conditions	Minimum Performance ⁽¹⁾				
Air-cooled, floor-mounted, with or without fluid economizer	< 23	AHRI 1361 (SI)	Downflow or upflow, ducted	SCOP = 2.67				
	≥ 23 and < 86			SCOP = 2.55				
	≥ 86			SCOP = 2.33				
	< 23		Upflow, non-ducted Horizontal	SCOP = 2.09				
≥ 23 and < 70	Upflow, non-ducted Horizontal		SCOP = 1.99					
≥ 70	Upflow, non-ducted Horizontal		SCOP = 1.81					
Water-cooled, floor-mounted, with or without fluid economizer	< 23		AHRI 1361 (SI)	Downflow or upflow, ducted	SCOP = 2.74			
	≥ 23 and < 86				SCOP = 2.65			
	≥ 86				SCOP = 2.61			
	< 23			Upflow, non-ducted Horizontal	SCOP = 2.44			
≥ 23 and < 70	Upflow, non-ducted Horizontal			SCOP = 2.34				
≥ 70	Upflow, non-ducted Horizontal			SCOP = 2.24				
Glycol-cooled, floor-mounted, with or without fluid economizer	< 23			AHRI 1361 (SI)	Downflow or upflow, ducted	SCOP = 2.48		
	≥ 23 and < 86					SCOP = 2.16		
	≥ 86					SCOP = 2.12		
	< 23				Upflow, non-ducted Horizontal	SCOP = 2.34		
≥ 23 and < 70	Upflow, non-ducted Horizontal	SCOP = 1.99						
≥ 70	Upflow, non-ducted Horizontal	SCOP = 1.94						
Air-cooled, ceiling-mounted, free air discharge condenser, with or without fluid economizer	< 8.5	AHRI 1361 (SI)			Ducted	SCOP = 2.01		
	≥ 8.5 and < 19				Non-ducted	SCOP = 2.04		
	≥ 19				Ducted	SCOP = 1.97		
Air-cooled, ceiling-mounted, ducted condenser, with or without fluid economizer	< 8.5				AHRI 1361 (SI)	Non-ducted	SCOP = 2.00	
	≥ 8.5 and < 19		Ducted			SCOP = 1.87		
	≥ 19		Non-ducted			SCOP = 1.89		
Water-cooled, ceiling-mounted, with or without fluid economizer	< 8.5		AHRI 1361 (SI)			Ducted	SCOP = 1.82	
	≥ 8.5 and < 19					Non-ducted	SCOP = 1.68	
	≥ 19					Ducted	SCOP = 1.78	
Glycol-cooled, ceiling-mounted, with or without fluid economizer	< 8.5					AHRI 1361 (SI)	Non-ducted	SCOP = 1.81
	≥ 8.5 and < 19			Ducted			SCOP = 1.68	
	≥ 19			Non-ducted			SCOP = 1.70	
Air-cooled, ceiling-mounted, free air discharge condenser, with or without fluid economizer	< 8.5			AHRI 1361 (SI)			Ducted	SCOP = 2.33
	≥ 8.5 and < 19						Non-ducted	SCOP = 2.36
	≥ 19						Ducted	SCOP = 2.23
Water-cooled, ceiling-mounted, with or without fluid economizer	< 8.5						AHRI 1361 (SI)	Non-ducted
	≥ 8.5 and < 19	Ducted						SCOP = 2.13
	≥ 19	Non-ducted						SCOP = 2.16
Glycol-cooled, ceiling-mounted, with or without fluid economizer	< 8.5	AHRI 1361 (SI)						Ducted
	≥ 8.5 and < 19				Non-ducted			SCOP = 1.95
	≥ 19				Ducted			SCOP = 1.88
Air-cooled, ceiling-mounted, free air discharge condenser, with or without fluid economizer	< 8.5				AHRI 1361 (SI)			Non-ducted
	≥ 8.5 and < 19		Ducted					SCOP = 1.73
	≥ 19		Non-ducted					SCOP = 1.76

Table 5.2.12.1.-H (Continued)

Notes to Table 5.2.12.1.-H:

(1) The symbols and abbreviations that appear in this column have the following meanings:

SCOP = sensible *coefficient of performance*. The SCOP is a ratio that is calculated by dividing the net sensible cooling capacity, in W, by the total power input, in W (excluding re-heaters and humidifiers).

Table 5.2.12.1.-I
Performance Requirements for Variable Refrigerant Flow Systems
 Forming Part of Sentences 5.2.12.1.(1), 6.2.2.4.(2), 6.2.2.5.(1) and 8.4.4.18.(6)

Type of Equipment	Cooling or Heating Capacity, kW	Performance Testing Standard	Rating Conditions	Minimum Performance ⁽¹⁾
Air-cooled air conditioners and heat pumps, with or without heat recovery ⁽²⁾	< 19	CSA C656	See standard	SEER = 15 / HSPF V = 7.8 ⁽³⁾
Air-cooled air conditioners	≥ 19 and < 40	AHRI 1230	See standard	EER = 11.2 IEER = 15.5
	≥ 40 and < 70			EER = 11.0 IEER = 14.9
	≥ 70			EER = 10.0 IEER = 13.9
Air-source heat pumps, with or without heat recovery	≥ 19 and < 40	AHRI 1230	See standard	EER = 10.8 IEER = 14.4 COP _h = 3.30 evaluated at 8.3°C db / 6.1°C wb COP _h = 2.25 evaluated at -8.3°C db / -9.4°C wb
	≥ 40 and < 70			EER = 10.4 IEER = 13.7 COP _h = 3.20 evaluated at 8.3°C db / 6.1°C wb COP _h = 2.05 evaluated at -8.3°C db / -9.4°C wb
	≥ 70			EER = 9.3 IEER = 12.5 COP _h = 3.20 evaluated at 8.3°C db / 6.1°C wb COP _h = 2.05 evaluated at -8.3°C db / -9.4°C wb
Water-source heat pumps, with or without heat recovery	< 40	AHRI 1230	See standard	EER = 11.8 IEER = 15.8 COP _h = 4.3
	≥ 40			EER = 9.8 IEER = 12.0 COP _h = 4.0
Groundwater source heat pumps, with or without heat recovery	< 40	AHRI 1230	See standard	EER = 16.2 COP _h = 3.6
	≥ 40			EER = 13.8 COP _h = 3.3
Ground-source heat pumps, with or without heat recovery	< 40	AHRI 1230	See standard	EER = 13.2 COP _h = 3.1
	≥ 40			EER = 10.8 COP _h = 2.8

Notes to Table 5.2.12.1.-I:

(1) The symbols and abbreviations that appear in this column have the following meanings:

COP_h = *coefficient of performance* in heating mode, in W/W

Table 5.2.12.1.-I (Continued)

- db = dry-bulb outdoor air temperature
- EER = *energy-efficiency ratio*, in (Btu/h)/W
- HSPF V = heating seasonal performance factor for region V (see map in CSA C656), in (Btu/h)/W
- IEER = *integrated energy-efficiency ratio*, in (Btu/h)/W
- SEER = *seasonal energy-efficiency ratio*, in (Btu/h)/W
- wb = wet-bulb outdoor air temperature

- (2) Components or equipment regulated in the “Energy Efficiency Regulations” at the time of publication of the Code (see Article 1.1.1.3. of Division A).
- (3) SEER applies to air conditioners, and both SEER and HSPF V apply to heat pumps.

Table 5.2.12.1.-J
Performance Requirements for Direct-Expansion Dedicated Outdoor Air Systems
 Forming Part of Sentences 5.2.12.1.(1), 6.2.2.4.(2), 6.2.2.5.(1) and 8.4.4.18.(6)

Type of Equipment	Cooling or Heating Capacity, kW	Performance Testing Standard	Rating Conditions	Minimum Performance ⁽¹⁾
Air-cooled	All capacities	ANSI/AHRI 921 (SI)	See standard	ISMRE = 1.8
Air-source heat pumps			See standard	ISMRE = 1.8 ISCOP = 1.2
Water-cooled			Cooling tower / condenser water	ISMRE = 2.2
			Chilled water	ISMRE = 2.7
Water-source heat pumps			Water source	ISMRE = 1.8 ISCOP = 3.5
			Groundwater source	ISMRE = 2.3 ISCOP = 3.2
			Ground-source, closed loop	ISMRE = 2.2 ISCOP = 2.0
Air-cooled, with energy recovery			See standard	ISMRE = 2.4
Air-source heat pumps, with energy recovery			See standard	ISMRE = 2.4 ISCOP = 3.3
Water-cooled, with energy recovery			Cooling tower / condenser water	ISMRE = 2.4
			Chilled water	ISMRE = 3.0
Water-source heat pumps, with energy recovery			Water source	ISMRE = 2.2 ISCOP = 4.8
			Groundwater source	ISMRE = 2.6 ISCOP = 4.0
			Ground-source, closed loop	ISMRE = 2.4 ISCOP = 3.8

Notes to Table 5.2.12.1.-J:

- (1) The symbols and abbreviations that appear in this column have the following meanings:
 IS COP = integrated seasonal *coefficient of performance*
 ISMRE = integrated seasonal moisture removal efficiency, in kg of moisture/kWh

Table 5.2.12.1.-K
Performance Requirements for Packaged Water Chillers⁽¹⁾
 Forming Part of Sentences 5.2.12.1.(1), 6.2.2.4.(2), 6.2.2.5.(1) and 8.4.4.18.(6)

Type of Equipment	Cooling or Heating Capacity, kW	Performance Testing Standard	Rating Conditions	Minimum Performance ⁽²⁾	
				Path A ⁽³⁾	Path B ⁽³⁾
Air-cooled, with or without remote condensers, all types of compressors	< 528	CAN/CSA-C743	See standard	COP _c = 2.985 IPLV = 4.048	COP _c = 2.866 IPLV = 4.669
	≥ 528			COP _c = 2.985 IPLV = 4.137	COP _c = 2.866 IPLV = 4.758
Water-cooled, rotary screw, scroll, or reciprocating compressor	< 264			COP _c = 4.694 IPLV = 5.867	COP _c = 4.513 IPLV = 7.041
	≥ 264 and < 528			COP _c = 4.889 IPLV = 6.286	COP _c = 4.694 IPLV = 7.184
	≥ 528 and < 1 055			COP _c = 5.334 IPLV = 6.519	COP _c = 5.177 IPLV = 8.001
	≥ 1 055 and < 2 110			COP _c = 5.771 IPLV = 6.770	COP _c = 5.633 IPLV = 8.586
	≥ 2 110			COP _c = 6.286 IPLV = 7.041	COP _c = 6.018 IPLV = 9.264
Water-cooled, centrifugal compressor	< 528			COP _c = 5.771 IPLV = 6.401	COP _c = 5.065 IPLV = 8.001
	≥ 528 and < 1 055			COP _c = 5.771 IPLV = 6.401	COP _c = 5.544 IPLV = 8.801
	≥ 1 055 and < 1 407			COP _c = 6.286 IPLV = 6.770	COP _c = 5.917 IPLV = 9.027
	≥ 1 407			COP _c = 6.286 IPLV = 7.041	COP _c = 6.018 IPLV = 9.264
Single-effect absorption, air-cooled	All capacities			COP _c = 0.600	
Single-effect absorption, water-cooled				COP _c = 0.700	
Double-effect absorption, indirect fire				COP _c = 1.000 IPLV = 1.050	
Double-effect absorption, direct fire				COP _c = 1.000 IPLV = 1.000	

Notes to Table 5.2.12.1.-K:

(1) Components or equipment regulated in the “Energy Efficiency Regulations” at the time of publication of the Code (see Article 1.1.1.3. of Division A).

(2) The symbols and abbreviations that appear in this column have the following meanings:

COP_c = coefficient of performance in cooling mode, in W/W

IPLV = integrated part-load value (no units)

(3) Chillers are permitted to comply with either Path A or Path B of CAN/CSA-C743. Path A is generally better suited to full-load applications (i.e., where chillers operate a significant amount of the time at full load), while Path B is generally better suited to part-load applications.

Table 5.2.12.1.-L
Performance Requirements for Heat Pumps and Heat Recovery Chiller Packages
 Forming Part of Sentences 5.2.12.1.(1), 6.2.2.4.(2), 6.2.2.5.(1) and 8.4.4.18.(6)

Type of Equipment	Cooling or Heating Capacity, kW	Performance Testing Standard	Rating Conditions	Minimum Performance ⁽¹⁾	
				Path A ⁽²⁾	Path B ⁽²⁾
Air-source heat pumps, in cooling mode	< 528	ANSI/AHRI 551/591 (SI)	See standard	COP _c = 2.836 IPLV = 3.846	COP _c = 2.723 IPLV = 4.436
	≥ 528			COP _c = 2.836 IPLV = 3.930	COP _c = 2.723 IPLV = 4.520
Water-source heat pumps and heat recovery chillers, rotary screw, scroll, or reciprocating compressor, in cooling mode	< 264			COP _c = 4.659 IPLV = 5.574	COP _c = 4.287 IPLV = 6.689
	≥ 264 and < 528			COP _c = 4.645 IPLV = 5.972	COP _c = 4.459 IPLV = 6.825
	≥ 528 and < 1 055			COP _c = 5.067 IPLV = 6.193	COP _c = 4.918 IPLV = 7.601
	≥ 1 055 and < 2 110			COP _c = 5.482 IPLV = 6.432	COP _c = 5.351 IPLV = 8.157
	≥ 2 110			COP _c = 5.072 IPLV = 6.689	COP _c = 5.717 IPLV = 8.801
Water-source heat pumps and heat recovery chillers, centrifugal compressor, in cooling mode	< 264			COP _c = 5.482 IPLV = 6.081	COP _c = 4.812 IPLV = 7.601
	≥ 264 and < 528			COP _c = 5.482 IPLV = 6.081	COP _c = 5.267 IPLV = 6.361
	≥ 528 and < 1 055			COP _c = 5.972 IPLV = 6.432	COP _c = 5.621 IPLV = 8.567
	≥ 1 055			COP _c = 5.972 IPLV = 6.689	COP _c = 5.717 IPLV = 8.801

Notes to Table 5.2.12.1.-L:

(1) The symbols and abbreviations that appear in this column have the following meanings:

COP_c = *coefficient of performance* in cooling mode, in W/W

IPLV = *integrated part-load value* (no units)

(2) Chillers are permitted to comply with either Path A or Path B of CAN/CSA-C743. Path A is generally better suited to full-load applications (i.e., where chillers operate a significant amount of the time at full load), while Path B is generally better suited to part-load applications.

Table 5.2.12.1.-M
Performance Requirements for Heat Pumps and Heat-Recovery Chiller Packages Based on Leaving Water Temperature
 Forming Part of Sentences 5.2.12.1.(1), 6.2.2.4.(2), 6.2.2.5.(1) and 8.4.4.18.(6)

Type of Equipment	Cooling or Heating Capacity, kW	Performance Testing Standard	Rating Conditions ⁽¹⁾	Minimum Performance ⁽²⁾		
				If LWT = 40°C	If LWT = 50°C	If LWT = 60°C
Air-source heat pumps, in heating mode	All capacities	ANSI/AHRI 551/591 (SI)	EAT = 8°C db / 6°C wb	COP _h = 3.350	COP _h = 2.720	COP _h = 2.330
			EAT = -8°C db / -9°C wb	COP _h = 2.250	COP _h = 1.920	COP _h = 1.640
Water-source heat pumps, rotary screw, scroll, reciprocating or centrifugal compressor, in heating mode	< 1 055		EST / LST = 12°C / 7°C	COP _h = 4.760	COP _h = 3.610	COP _h = 2.660
			EST / LST = 24°C / 19°C	—	—	COP _h = 3.530
	≥ 1 055		EST / LST = 12°C / 7°C	COP _h = 5.060	COP _h = 3.880	COP _h = 2.950
			EST / LST = 24°C / 19°C	—	—	COP _h = 3.870
Heat-recovery chillers, rotary screw, scroll, reciprocating or centrifugal compressor, simultaneous heating and cooling modes	< 1 055		EST / LST = 12°C / 7°C	COP _{hr} = 8.550	COP _{hr} = 6.290	COP _{hr} = 4.390
			EST / LST = 24°C / 19°C	—	—	COP _{hr} = 6.100
	≥ 1 055	EST / LST = 12°C / 7°C	COP _{hr} = 9.140	COP _{hr} = 6.850	COP _{hr} = 4.960	
		EST / LST = 24°C / 19°C	—	—	COP _{hr} = 6.800	

Notes to Table 5.2.12.1.-M:

(1) The symbols and abbreviations that appear in this column have the following meanings:

- db = dry-bulb outdoor air temperature
- EAT = entering air temperature
- EST = entering source temperature
- LST = leaving source temperature
- wb = wet-bulb outdoor air temperature

(2) The symbols and abbreviations that appear in this column have the following meanings:

- COP_h = coefficient of performance in heating mode, in W/W
- COP_{hr} = coefficient of performance in heat-recovery mode, in W/W
- LWT = leaving water temperature

Table 5.2.12.1.-N
Performance Requirements for Boilers
 Forming Part of Sentences 5.2.12.1.(1), 6.2.2.4.(2), 6.2.2.5.(1) and 8.4.4.18.(6)

Type of Equipment	Cooling or Heating Capacity, kW	Performance Testing Standard	Rating Conditions	Minimum Performance ⁽¹⁾
Electric	< 88	(2)	—	Must be equipped with automatic water temperature control ⁽³⁾
	≥ 88		—	—
Gas-fired ⁽⁴⁾	< 88	CAN/CSA-P-2	See standard	AFUE = 90% (water) ⁽³⁾ AFUE = 82% (steam) ⁽³⁾
	≥ 88 and < 733	DOE 10 CFR, Part 431, Subpart E, Appendix A	See standard	E _t ≥ 90% (water) E _t ≥ 81% (steam)
	≥ 733 and < 2 930		See standard	E _c ≥ 90% (water) E _t ≥ 82% (steam)

Table 5.2.12.1.-N (Continued)

Type of Equipment	Cooling or Heating Capacity, kW	Performance Testing Standard	Rating Conditions	Minimum Performance ⁽¹⁾
Oil-fired	< 88	CAN/CSA-P.2	See standard	AFUE = 86% (water) AFUE = 85% (steam)
	≥ 88 and < 733	DOE 10 CFR, Part 431, Subpart E, Appendix A	See standard	E _t = 87% (water) E _t = 84% (steam)
	≥ 733 and < 2 930		See standard	E _c = 88% (water) E _t = 85% (steam)

Notes to Table 5.2.12.1.-N:

- (1) The symbols and abbreviations that appear in this column have the following meanings:
 AFUE = annual fuel utilization efficiency
 E_c = combustion efficiency
 E_t = thermal efficiency
- (2) No standards address the heating performance efficiency of electric *boilers*; however, their *thermal efficiency* is typically normalized at 97% in the testing standards.
- (3) Components or equipment regulated in the “Energy Efficiency Regulations” at the time of publication of the Code (see Article 1.1.1.3. of Division A).
- (4) Includes propane.

Table 5.2.12.1.-O
Performance Requirements for Warm-Air Furnaces, Combination Warm-Air Furnace/Air-conditioning Units, Duct Furnaces and Unit Heaters
 Forming Part of Sentences 5.2.12.1.(1), 6.2.2.4.(2), 6.2.2.5.(1) and 8.4.4.18.(6)

Type of Equipment	Cooling or Heating Capacity, kW	Performance Testing Standard	Rating Conditions	Minimum Performance ⁽¹⁾
Electric <i>furnaces</i>	< 66	DOE 10 CFR, Part 430, Subpart B, Appendix Aa ⁽²⁾	—	FER = 0.044 × Q _{max} + 165 ⁽³⁾⁽⁴⁾
	≥ 66	⁽²⁾		—
Gas-fired warm-air <i>furnaces</i> ⁽⁵⁾⁽⁶⁾	≤ 66	CAN/CSA-P.2 and DOE 10 CFR, Part 430, Subpart B, Appendix Aa	Without integrated cooling	AFUE = 95% ⁽³⁾ FER = 0.044 × Q _{max} + 195
			Outdoor <i>furnaces</i> with integrated cooling	AFUE = 78% ⁽³⁾ FER = 0.044 × Q _{max} + 199
			Through-the-wall, with integrated cooling	AFUE = 90% ⁽³⁾ FER = 0.044 × Q _{max} + 195
	> 66 and ≤ 117	CSA/ANSI Z21.47/CSA 2.3	Three-phase electric supply	AFUE = 78% or E _t = 80%
			See standard	E _t = 81%
Gas-fired packaged <i>furnaces</i> ⁽⁵⁾	≤ 2 931	CAN/CSA-P.8, Annex C	See standard	E _t = 80%
Gas-fired duct <i>furnaces</i> ⁽⁵⁾⁽⁶⁾	≤ 2 931	ANSI Z83.8/CSA 2.6	See standard	E _t = 81%
Gas-fired <i>unit heaters</i> ⁽³⁾⁽⁵⁾	≤ 2 931	CAN/CSA-P.11	See standard	E _t = 82%
Oil-fired warm-air <i>furnaces</i>	≤ 66	CAN/CSA-P.2	See standard	E _t = 84.5% AFUE = 85% ⁽³⁾
	> 66	CSA B140.4	See standard	E _t = 82%
Oil-fired duct <i>furnaces</i> and <i>unit heaters</i>	All capacities	CSA B140.4	See standard	E _t = 81%

Notes to Table 5.2.12.1.-O:

- (1) The symbols and abbreviations that appear in this column have the following meanings:
 AFUE = annual fuel utilization efficiency
 E_t = thermal efficiency
 FER = fan energy rating, in W per 472 L/s

Table 5.2.12.1.-O (Continued)

Q_{\max} = maximum airflow provided by the furnace at test conditions, in cfm

- (2) No standards address the heating performance efficiency of electric furnaces; however, their thermal efficiency is typically normalized at 97% in the testing standard, which addresses fan efficiency rating only.
- (3) Components or equipment regulated in the “Energy Efficiency Regulations” at the time of publication of the Code (see Article 1.1.1.3. of Division A).
- (4) Must be equipped with a high-efficiency constant torque or constant airflow fan motor.
- (5) Includes propane.
- (6) Excludes gas-fired outdoor packaged units.

Table 5.2.12.1.-P
Performance Requirements for Other Fuel-Burning Equipment and Appliances
 Forming Part of Sentences 5.2.12.1.(1), 6.2.2.4.(2), 6.2.2.5.(1) and 8.4.4.18.(6)

Type of Equipment	Cooling or Heating Capacity, kW	Performance Testing Standard	Rating Conditions	Minimum Performance ⁽¹⁾
Gas-fired fireplaces and stoves, non-decorative	All capacities	CAN/CSA-P4.1	See standard	FE = 50%, with direct vent and without standing pilot light
Solid-fuel-burning stoves	All capacities	EPA 40 CFR, Part 60, Subpart AAA and Subpart QQQQ, and CSA B415.1	See standard	—
Solid-fuel-burning boilers	< 2 000	DIN EN 303-5	See standard	—
Gas-fired infrared heaters, high-intensity ⁽²⁾⁽³⁾	≤ 117 per burner	DIN EN 419	See standard	NRE ≥ 55%
Gas-fired infrared heaters, tubular and low-intensity ⁽²⁾⁽³⁾		DIN EN 416	See standard	NRE ≥ 45%

Notes to Table 5.2.12.1.-P:

- (1) The symbols and abbreviations that appear in this column have the following meanings:

E_o = overall efficiency

FE = fireplace efficiency

NRE = net radiant efficiency. NRE corresponds to the ratio of useful (dry) radiant output to the heat input. CAN/ANSI/AHRI 1330, “Performance Rating for Radiant Output of Gas Fired Infrared Heaters,” uses the same test methods as DIN EN 416 and DIN EN 419. However, CAN/ANSI/AHRI 1330 reports test results as gross radiant efficiency (GRE), which is the ratio between the corrected radiant output to the heat input and is about 6%–9% lower than NRE, or as infrared factor (IF), which relates to GRE.

- (2) Excludes gas-fired outdoor packaged units.

- (3) Includes gas-fired patio heaters, high- or low-intensity, as applicable.

5.2.12.2. Heat Rejection Equipment

1) Except for equipment covered by Article 5.2.12.1. whose performance includes heat rejection energy, this Article applies to standalone heat rejection equipment. (See Note A-5.2.12.2.(1).)

2) Standalone heat rejection equipment and their components shall comply with the performance requirements stated in Table 5.2.12.2.

3) Constant speed fans shall operate with cycling control to maintain the leaving fluid temperature or condensing temperature/pressure of the heat rejection equipment at the set-point.

Table 5.2.12.2.
Heat Rejection Equipment Performance Requirements
 Forming Part of Sentence 5.2.12.2.(2)

Type of Equipment	Heat Rejection Capacity	Performance Testing Standard	Rating Conditions	Performance Requirements ⁽¹⁾ , electrical kW / thermal kW ⁽²⁾
Cooling towers and fluid coolers				
centrifugal fan, direct-contact	All capacities	CTI ATC-105 ⁽³⁾ and CTI STD-201RS ⁽³⁾	35°C entering water 29.4°C leaving water 23.9°C wet bulb	≤ 0.026
propeller or axial fan, direct-contact			≤ 0.013	
centrifugal fan, indirect-contact evaporative		CTI ATC-105S and CTI STD-201RS	38.9°C entering water 32.2°C leaving water 23.9°C wet bulb	≤ 0.061
propeller or axial fan, indirect-contact evaporative			≤ 0.026	
propeller or axial fan, dry		CTI ATC-105DS	46.1°C entering water 40.6°C leaving water 35°C dry bulb	≤ 0.113
Condensers				
centrifugal fan, indirect-contact evaporative	All capacities	CTI ATC-106	R-717 test fluid: ⁽⁴⁾ 35.7°C condensing temperature 60°C entering gas temperature 23.9°C wet bulb	≤ 0.023
			R-448A test fluid: ⁽⁴⁾ 40.6°C condensing temperature 73.9°C entering gas temperature 23.9°C wet bulb	≤ 0.019
propeller or axial fan, indirect-contact evaporative			R-717 test fluid: ⁽⁴⁾ 35.7°C condensing temperature 60°C entering gas temperature 23.9°C wet bulb	≤ 0.019
			R-448A test fluid: ⁽⁴⁾ 40.6°C condensing temperature 73.9°C entering gas temperature 23.9°C wet bulb	≤ 0.016
air-cooled		ANSI/AHRI 460	51.7°C condensing temperature 87.8°C entering gas temperature 8.3°C subcooling 35°C dry bulb	≤ 0.015

Notes to Table 5.2.12.2.:

- (1) "Performance Requirements" refers to the maximum allowed total motor power demand (i.e. fan power demand combined with spray-pump power demand, where applicable) per unit of heat rejection capacity at rating conditions.
- (2) The effect of any project-specific accessories and options shall be included in the performance calculation of the heat rejection equipment.
- (3) The efficiencies and test procedures for both direct- and indirect-contact cooling towers are not applicable to hybrid cooling towers, which contain separate wet and dry heat exchange sections. The certification requirements stated in the standards do not apply to field-erected cooling towers.

Table 5.2.12.2. (Continued)

- (4) The R-717 test fluid refers to ammonia, and the R-448A test fluid is a zeotropic refrigerant. Evaporative condensers intended for use with halocarbon refrigerants other than R-448A must meet the minimum performance requirements listed in the Table with R-448A as the test fluid. For ammonia, the condensing temperature is defined as the saturation temperature corresponding to the refrigerant pressure at the condenser entrance. For R-448A, the condensing temperature is defined as the arithmetic average of the dew point and the bubble point temperatures corresponding to the refrigerant pressure at the condenser entrance.

5.2.12.3. Field-Assembled Equipment and Components

1) Where components from more than one manufacturer are used as parts of a heating, ventilating or air-conditioning system, the system shall be designed in accordance with good engineering practice and based on component efficiency data provided by the component manufacturers so as to provide the overall efficiency required by Article 5.2.12.1.

5.2.12.4. Service Water Heating Equipment Used for Space Heating

1) *Service water* heating equipment used solely to provide space heating or used to provide a combination of space and *service water* heating shall comply with the applicable standard listed in Table 6.2.2.1. or, where such equipment is not covered in this Table, with the “Energy Efficiency Act” and the “Energy Efficiency Regulations.”

Section 5.3. Reserved

Section 5.4. Performance Path

(See Note A-1.1.2.1.)

5.4.1. General

5.4.1.1. Scope

1) Subject to the limitations stated in Article 5.4.1.2., where the heating, ventilating and air-conditioning system does not comply with the requirements of Section 5.2., it shall comply with Part 8.

5.4.1.2. Limitations

1) Notwithstanding use of the performance path, all HVAC appliances and equipment shall comply with the applicable appliance or equipment energy efficiency act or, in the absence of such an act or where the appliance or equipment is not covered by such an act, with the applicable performance standard.

2) This Section does not apply to back-up HVAC systems, which shall comply with Sentence 5.1.1.3.(2).

Section 5.5. Objective and Functional Statements

5.5.1. Objective and Functional Statements

5.5.1.1. Attributions to Acceptable Solutions

1) For the purpose of compliance with this Code as required in Clause 1.2.1.1.(1)(b) of Division A, the objective and functional statements attributed to the acceptable solutions in this Part shall be the objective and functional statements listed in Table 5.5.1.1. (See Note A-1.1.3.1.(1).)

Table 5.5.1.1.
Objectives and Functional Statements Attributed to the
Acceptable Solutions in Part 5
 Forming Part of Sentence 5.5.1.1.(1)

Provision	Functional Statements and Objectives ⁽¹⁾
5.2.2.2. Provision for Balancing	
(1)	[F95,F99-OE1.1]
5.2.2.3. Duct Sealing	
(1)	[F91,F99-OE1.1]
(2)	[F91,F99-OE1.1]
(5)	[F91,F99-OE1.1]
5.2.2.4. Leakage Testing of Ducts	
(1)	[F91,F99-OE1.1]
(2)	[F91,F99-OE1.1]
5.2.2.5. Duct and Plenum Insulation	
(1)	[F92,F93-OE1.1]
(2)	[F93,F95-OE1.1]
(6)	[F93-OE1.1]
(8)	[F92,F93-OE1.1]
(9)	[F93,F95,F99-OE1.1]
5.2.2.6. Protection of Duct Insulation	
(1)	[F92,F93,F95-OE1.1]
(2)	[F92,F93,F95-OE1.1]
5.2.2.7. Cooling with Outdoor Air	
(1)	[F95-OE1.1]
5.2.2.8. Cooling by Direct Use of Outdoor Air (Air Economizer System)	
(1)	[F95-OE1.1]
(2)	[F95-OE1.1]
(3)	[F95-OE1.1]
(4)	[F95-OE1.1]
(5)	[F95-OE1.1]
5.2.2.9. Cooling by Indirect Use of Outdoor Air (Water Economizer System)	
(1)	[F95-OE1.1]
(2)	[F95-OE1.1]
5.2.3.1. Application	
(2)	[F95,F97-OE1.1]
5.2.3.2. Constant-Volume Fan Systems	
(1)	[F95,F97-OE1.1]
5.2.3.3. Variable-Air-Volume Fan Systems	
(1)	[F95,F97-OE1.1]
(2)	[F95,F97-OE1.1]
(3)	[F95,F97-OE1.1]
5.2.3.4. Demand Control Ventilation Systems	
(1)	[F95,F97-OE1.1]

Table 5.5.1.1. (Continued)

Provision	Functional Statements and Objectives ⁽¹⁾
(2)	[F95,F97-OE1.1]
5.2.4.1. Required Dampers	
(1)	[F91,F95-OE1.1]
5.2.4.2. Type and Location of Dampers	
(1)	[F90,F91,F95-OE1.1]
(2)	[F90,F91,F95-OE1.1]
(3)	[F92,F95-OE1.1]
5.2.5.2. Provision for Balancing	
(1)	[F95,F99-OE1.1]
5.2.5.3. Piping Insulation	
(1)	[F92,F93-OE1.1]
(4)	[F92,F93-OE1.1]
(6)	[F92,F93-OE1.1]
(7)	[F92,F93-OE1.1]
(8)	[F93,F95-OE1.1]
(9)	[F93,F95,F99-OE1.1]
5.2.5.4. Protection of Piping Insulation	
(1)	[F92,F93,F95-OE1.1]
(2)	[F92,F93,F95-OE1.1]
5.2.6.1. Application	
(2)	[F95-OE1.1]
5.2.6.2. Variable-Flow Pumping Systems	
(1)	[F95,F97-OE1.1]
5.2.6.3. Pumping Power Demand	
(1)	[F95,F97,F98,F99-OE1.1]
5.2.7.1. Manufacturer's Designation	
(1)	[F95,F99-OE1.1]
5.2.8.1. Temperature Controls	
(1)	[F95-OE1.1]
(2)	[F95-OE1.1]
5.2.8.2. Temperature Control within Dwelling Units	
(1)	[F95-OE1.1]
(2)	[F95-OE1.1]
5.2.8.3. Temperature Control in Guest Rooms and Suites in Commercial Temporary Lodgings	
(1)	[F95-OE1.1]
5.2.8.4. Installation of Thermostats	
(1)	[F95-OE1.1]
5.2.8.5. Heat Pump Controls	
(1)	[F95,F97,F99-OE1.1]
5.2.8.6. Space Temperature Control	
(1)	[F95-OE1.1]
(2)	[F95-OE1.1]

Table 5.5.1.1. (Continued)

Provision	Functional Statements and Objectives ⁽¹⁾
(3)	[F95-OE1.1]
(4)	[F95-OE1.1]
(5)	[F95-OE1.1]
5.2.8.7. Ice- and Snow-Melting Heater Controls	
(1)	[F95-OE1.1]
5.2.8.8. Control of Temperature of Air Leaving the Supply Air Handler	
(1)	[F95-OE1.1]
5.2.8.9. Control of Space Temperature by Reheating or Recooling	
(1)	[F95-OE1.1]
(2)	[F95-OE1.1]
(3)	[F95-OE1.1]
5.2.9.1. Humidification Controls	
(1)	[F95-OE1.1]
5.2.10.1. Energy Recovery Systems	
(1)	[F95,F100-OE1.1]
(2)	[F95,F100-OE1.1]
(4)	[F95,F100-OE1.1]
(5)	[F95,F100-OE1.1]
(6)	[F95-OE1.1]
5.2.10.2. Heat Recovery from Dehumidification in Swimming Pools	
(1)	[F95,F100-OE1.1]
5.2.10.3. Heat Recovery from Ice-making Machines in Ice Arenas and Curling Rinks	
(1)	[F95,F96,F100-OE1.1]
5.2.10.4. Heat Recovery in Dwelling Units	
(1)	[F95,F100-OE1.1]
(2)	[F95,F100-OE1.1]
(3)	[F95,F100-OE1.1]
(4)	[F95,F100-OE1.1]
(5)	[F95,F100-OE1.1]
5.2.11.1. Off-hours Controls	
(1)	[F95-OE1.1]
(2)	[F95-OE1.1]
(4)	[F95-OE1.1]
5.2.11.2. Airflow Control Areas	
(1)	[F95,F97-OE1.1]
(2)	[F95,F97-OE1.1]
(3)	[F95,F97-OE1.1]
(4)	[F95,F97-OE1.1]
(5)	[F95,F97-OE1.1]
(6)	[F95,F97-OE1.1]
(7)	[F95,F97,F99-OE1.1]

Table 5.5.1.1. (Continued)

Provision	Functional Statements and Objectives ⁽¹⁾
5.2.11.3. Seasonal Shutdown	
(1)	[F97-OE1.1]
5.2.11.4. Multiple Boilers	
(1)	[F93-OE1.1]
(2)	[F95-OE1.1]
(3)	[F95-OE1.1]
5.2.11.5. Loop Temperature Reset for Chilled- and Hot-Water Systems	
(1)	[F95,F98-OE1.1]
5.2.12.1. Unitary and Packaged HVAC Equipment	
(1)	[F95,F98,F99-OE1.1]
5.2.12.2. Heat Rejection Equipment	
(2)	[F95,F97,F98,F99-OE1.1]
(3)	[F95,F97-OE1.1]
5.2.12.3. Field-Assembled Equipment and Components	
(1)	[F99-OE1.1]
5.2.12.4. Service Water Heating Equipment Used for Space Heating	
(1)	[F98-OE1.1]
5.4.1.2. Limitations	
(1)	[F98,F99-OE1.1]

Notes to Table 5.5.1.1.:

(1) See Parts 2 and 3 of Division A.

Notes to Part 5 Heating, Ventilating and Air-conditioning Systems

A-5.1.1.2.(2) Exemptions. Since any list of potentially exempted spaces or equipment would necessarily be incomplete, only a broad exemption statement can be provided in the Code. One example of a space that could be exempted from complying with certain Part 5 requirements is a building or room in which the processes or activities call for temperature or humidity conditions outside the normal range required for comfort.

A-5.1.1.3.(1) Compliance. The flow chart in Figure A-5.1.1.3.(1) illustrates the process for the two paths of compliance applicable to Part 5.

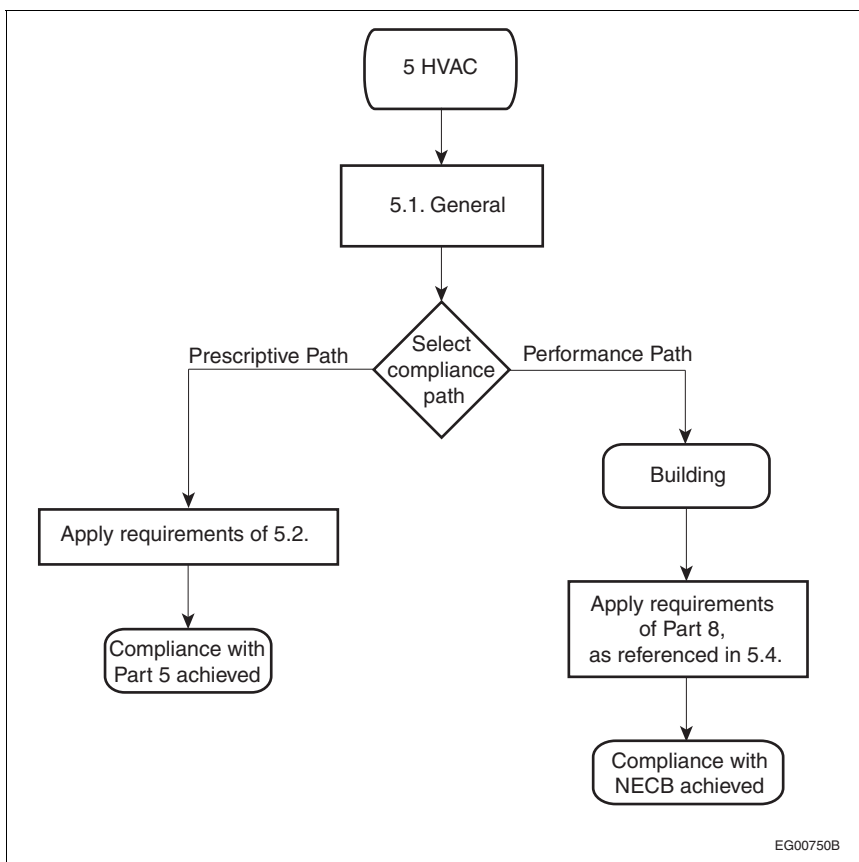

Figure A-5.1.1.3.(1)
Code compliance paths for HVAC

These Notes are included for explanatory purposes only and do not form part of the requirements. The number that introduces each Note corresponds to the applicable requirement in this Part.

A-5.1.1.3.(2) Back-up Systems. “Back-up systems” are systems installed within a building for the sole purpose of operating in the event the building’s primary system is out of service due to malfunction or scheduled maintenance.

A-5.2.1.1.(1) Load Calculations. ASHRAE Handbooks and Standards and, for smaller buildings, the “HRAI Digest,” are also useful sources of information on HVAC systems.

A-5.2.2.1.(1) Design and Installation of Ducts. The following publications are a useful source of additional information on this subject:

- Publications by ASHRAE:
 - the ASHRAE Handbooks
- Publications by SMACNA:
 - “HVAC Duct Construction Standards – Metal and Flexible”
 - “Fibrous Glass Duct Construction Standards ”
 - “HVAC Systems Duct Design”
 - “HVAC Air Duct Leakage Test Manual”

A-5.2.2.2.(1) Provision for Balancing. Balancing an air distribution system is a means of fine-tuning it so that the correct amount of air for which the heating, ventilating or air-conditioning system is designed can be delivered. Except for systems having some other means of air-volume control, such as variable air-volume systems, major supply air ducts such as main, sub-main or branch ducts intended to carry conditioned air must contain air-volume balancing dampers capable of being set for specified airflows.

A-5.2.2.3.(1) SMACNA Duct Sealing Classification. Table A-5.2.2.3.(1) provides examples of how to achieve the SMACNA air duct leakage seal classes.

Table A-5.2.2.3.(1)
SMACNA Duct Sealing Classification

Static Pressure Class	Seal Class	Description
≤ 2	C	Sealing required at transverse joints
> 2 and < 4	B	Sealing required at all transverse joints and longitudinal seams
≥ 4	A	Sealing required at all transverse joints, longitudinal seams and duct wall penetrations

A-5.2.2.3.(4) Duct Sealing Exemption. The exemption afforded by Sentence 5.2.2.3.(4) does not apply to ducts in ceiling plenums or other service spaces that are immediately adjacent to the conditioned space served by the ducts.

The rationale behind the exemption from compliance with Sentence 5.2.2.3.(1) is that the energy penalty would be insignificant if a little supply air from a duct located in the same conditioned space to which it is supplying air leaks into the conditioned space before it gets to the diffuser. However, if there is a controlled element, such as a reheat coil, mixing box or variable-air-volume box or a damper, between the leak and the diffuser, a more significant energy loss may result; these types of elements are therefore required to comply with Sentence 5.2.2.3.(1).

A-5.2.2.4.(1) Leakage Testing of Ducts. The choice of ducts to be tested is left to the authority having jurisdiction.

A-5.2.2.5.(2), 5.2.5.3.(8) and 6.2.3.1.(6) Insulation Thickness. Insulation must be installed sufficiently tightly around ductwork to avoid leaving an air gap between the duct and the insulation. However, in doing so, care must be taken not to deform the insulation through excessive stretching or compression, as this will reduce its thickness and, consequently, its thermal performance.

A-5.2.2.5.(4) Insulation Exemption for Supply Ducts and Plenums. Supply ducts and plenums, and their run-outs, need not be thermally insulated if they only serve the conditioned space in which they are located. However, any sections of this supply ductwork that pass through unconditioned spaces or through conditioned spaces (whether or not they serve the spaces) before reaching the final conditioned space served by the ductwork must be insulated in accordance with Article 5.2.2.5.

Figure A-5.2.2.5.(4) illustrates an example of the proper application of this Article. In this example, the central air-handling unit supply plenum is located outside the conditioned spaces it serves and must be insulated. Likewise, the sections of the supply ducts that are located outside the final conditioned space served by the ducts must be insulated. The fan coil supply plenum and the supply run-outs in all the conditioned spaces need not be insulated, since they are located within the conditioned space they serve.

Designers should consider the length of uninsulated supply ducts and the temperature difference between the supply air and the air surrounding the ducts when deciding whether measures beyond the requirements of Article 5.2.2.5. are needed. For instance, uninsulated supply ducts used for cooling may be subject to condensation issues (see Note A-5.2.5.3.(1)).

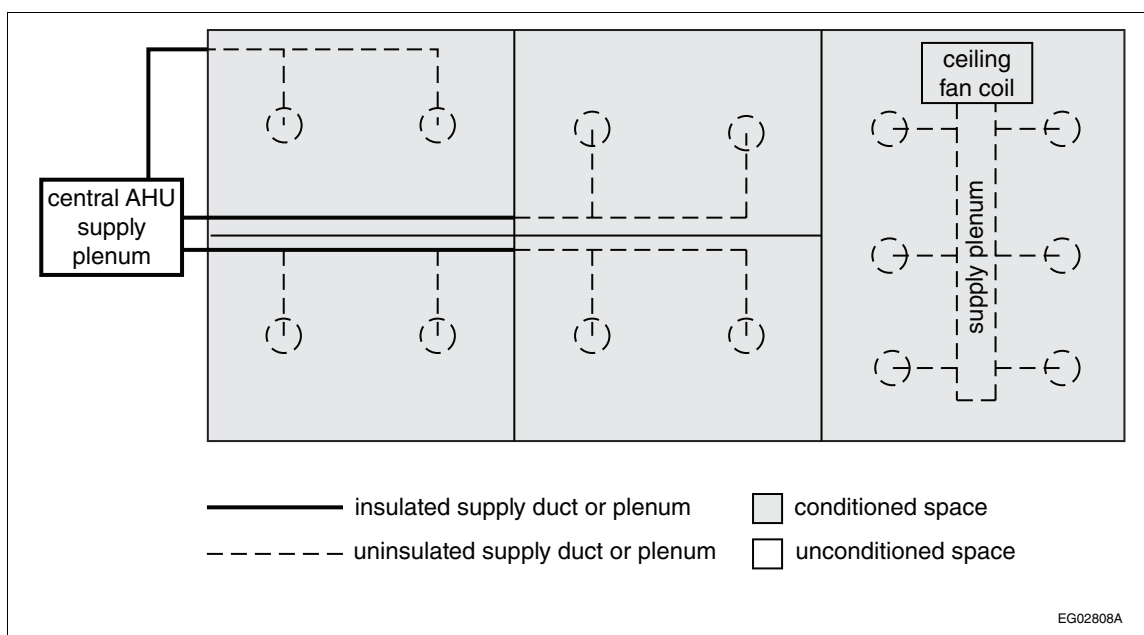

Figure A-5.2.2.5.(4)
Example of duct and plenum insulation in conditioned and unconditioned spaces

Note to Figure A-5.2.2.5.(4):

(1) AHU = air-handling unit

A-5.2.2.5.(8) and 5.2.5.3.(7) Installation Standards. For the purposes of Sentences 5.2.2.5.(8) and 5.2.5.3.(7), "good practice" includes the TIAC "Mechanical Insulation Best Practices Guide."

A-5.2.2.8.(2) Outdoor Air Intake for Acceptable Indoor Air Quality. Outdoor air requirements for acceptable indoor air quality are covered in Part 6 of Division B of the NBC.

High-Limit Shut-off

All air economizers should be capable of automatically reducing outdoor air intake to the design minimum outdoor air quantity when outdoor air intake no longer reduces cooling energy usage. Table A-5.2.2.8.(2) shows the high-limit shut-off settings for different types of air economizers.

Table A-5.2.2.8.(2)
High-Limit Shut-off (HLSO) Control Settings for Air Economizers

Type of HLSO Control ⁽¹⁾	Conditions at which Air Economizer Turns Off	
	Equation ⁽²⁾	Description
Fixed dry bulb ⁽³⁾	$T_{OA} > T_{setpoint}$, where $21^{\circ}\text{C} \leq T_{setpoint} \leq 24^{\circ}\text{C}$	Outdoor air temperature exceeds HLSO set-point temperature of air economizer
Differential dry bulb	$T_{OA} > T_{RA}$	Outdoor air temperature exceeds return air temperature

Table A-5.2.2.8.(2) (Continued)

Type of HLSO Control ⁽¹⁾	Conditions at which Air Economizer Turns Off	
	Equation ⁽²⁾	Description
Electronic enthalpy ⁽⁴⁾	$(T_{OA}, RH_{OA}) > A$	Outdoor air temperature/RH exceeds the "A" setpoint curve ⁽⁵⁾
Differential enthalpy	$h_{OA} > h_{RA}$	Outdoor air enthalpy exceeds return air enthalpy
Dew-point and dry-bulb temperatures	$DP_{oa} > 13^{\circ}\text{C}$ or $T_{oa} > 24^{\circ}\text{C}$	Outdoor air dry bulb exceeds 24°C or outside dew point exceeds 13°C (9.3 g/kg)

Notes to Table A-5.2.2.8.(2):

- (1) Fixed enthalpy is a prohibited type of control for the climate zones to which the NECB applies, namely zones 4 to 8.
- (2) T_{OA} = temperature outdoor air; T_{RA} = temperature return air; h_{OA} = enthalpy outdoor air; RH_{OA} = relative humidity outdoor air; h_{RA} = enthalpy return air; DP_{OA} = dew point outdoor air
- (3) Air economizer systems should have an adjustable HLSO set-point range between 21°C and 24°C so that energy consumption for cooling can be minimized based on the building's location: air economizers in buildings in locations with a higher relative humidity during the cooling season would require a lower HLSO setting approaching 21°C, while those in drier locations would use an HLSO setting approaching 24°C.
- (4) Electronic enthalpy controls use a combination of humidity and dry-bulb temperature in their switching algorithm.
- (5) Setpoint "A" corresponds to a curve on the psychrometric chart that goes through a point at approximately 24°C and 40% relative humidity and is nearly parallel to dry-bulb lines at low humidity levels and nearly parallel to enthalpy lines at high humidity levels.

A-5.2.2.8.(6) Controls to Allow Proper Operation of Direct Expansion Systems. Preventing frost build-up on coils is an example of how the controls referred to in Sentence 5.2.2.8.(6) enable the proper operation of the equipment.

A-5.2.3.1.(2) Fan System Design. Although the allowed maximum power demand of a fan system is based solely on the supply airflow, the calculation of actual power demand includes supply fans, return fans, relief fans, and fans for series fan-powered boxes, but not parallel-powered boxes or exhaust fans such as bathroom or laboratory exhausts.

A-5.2.3.2.(1) Constant-Volume Fan Systems. This type of system includes bypass variable-air-volume systems in which the airflow through the fan is not varied.

Both supply and return fans must be accounted for, but not exhaust fans.

The power demand of the motors refers to the power drawn by the motors and not their nameplate rating.

A-5.2.3.3.(1) Variable-Air-Volume Fan Systems. The power demand of supply, relief and return fans—but not that of exhaust fans—must be accounted for in Sentence 5.2.3.2.(1).

The power demand of fans for series-fan-powered boxes—but not that of fans in parallel-fan-powered boxes—must be accounted for in Sentence 5.2.3.2.(1).

The power demand of the motors refers to the power drawn by the motors and not their nameplate rating.

A-5.2.3.4.(1) Demand Control Ventilation Systems.

Enclosed Spaces Where Fuel-Powered Equipment is Used

Examples of enclosed spaces targeted by Sentence 5.2.3.4.(1) are indoor sports arenas where fuel-powered equipment is used for maintenance of the play area (such as an ice-surfacing vehicle in an ice-rink arena), warehouses with propane-fueled forklifts, and heated indoor storage garages. In such spaces, contaminant levels are often controlled through on-and-off staging of a dedicated fan system. However, some ventilation systems use variable-speed fans to modulate between a set minimum (which can be as low as 0 when the contaminant levels are low enough) and the peak airflow rates needed to control the levels of contaminants in the air. Air contaminants generally controlled by such systems are carbon monoxide (CO) and nitrous oxides (NOx), depending on the type of fuel used.

Spaces where fuel-powered vehicles or mobile fuel-powered equipment or appliances are used on a semi-continuous basis (e.g., multiple forklifts actively used in a distribution warehouse) may be exempted from complying with Sentence 5.2.3.4.(1), subject to the approval of the authority having jurisdiction. However, some standards, such as ANSI/ASHRAE 62.1, "Ventilation for Acceptable Indoor Air Quality,"

still require a minimum ventilation rate based on occupancy or other activities carried out in the space. It is expected that a means will be provided to evacuate exhaust air from fixed fuel-powered appliances and equipment directly to the outdoors. Thus, only spaces where vehicles or mobile equipment or appliances with combustion engines are used are targeted by this requirement.

General

Instead of providing constant airflow at peak design rates like traditional ventilation systems, demand control ventilation systems include strategies designed to modulate the minimum outdoor airflow rates required for some applications, based on a dynamic variable such as transient occupancy or vented process use.

Demand control ventilation is recognized as being an effective energy efficiency measure for certain applications and the strategies listed in Article 5.2.3.4. are deemed reliable. However, the effectiveness of other demand control ventilation strategies can vary significantly according to the application for which they are being used and their implementation, occupant density, and the type, placement and calibration of the sensor.

Most notably, the improper implementation of CO₂-based demand control ventilation systems that modulate outdoor airflow rates to occupied spaces can lead to the over- or under-ventilation of the spaces, resulting in either excessive energy use or health and safety issues for the occupants. Thus, demand control ventilation strategies should be implemented in accordance with the latest best practices. See ASHRAE publications or other applicable documents for additional information.

A-5.2.3.4.(2) Demand Control Ventilation Systems for Commercial Kitchens. The conditioning of the outdoor air that is required to replace the air exhausted from a commercial kitchen, along with the associated fan energy, imposes a significant energy burden, typically representing more than half of the total HVAC load in a commercial food-service facility. The energy consumption of ventilation systems that are installed in quick-service, full-service and institutional facility kitchens can be greatly reduced through the installation of demand control ventilation systems. These systems adjust the amount of exhaust air required to maintain acceptable conditions for kitchen staff based on the cooking load, which varies throughout the day. They reduce the volume of exhaust and make-up air through fan staging or variable speed drives.

Typically, a commercial kitchen exhaust system consists of one exhaust fan, which is ducted to one or more kitchen exhaust hoods, and a make-up-air unit. While quick-service restaurants will have one to three hoods with individual exhaust fans, with total system exhaust quantities ranging from 708 L/s (1 500 cfm) to 2 360 L/s (5 000 cfm), the largest commercial kitchens (institutional food-service facilities) may have four to eight hoods, with an exhaust fan ducted to one or two hoods, and total kitchen exhaust volumes ranging from 7 551 L/s (16 000 cfm) to 14 158 L/s (30 000 cfm). To summarize, institutional food-service kitchens may have up to four kitchen exhaust “systems,” which would individually require the demand control ventilation technology.

ANSI/ASHRAE/IES 90.1, “Energy Standard for Buildings Except Low-Rise Residential Buildings,” recognizes that demand control ventilation is a key factor in the design of energy-efficient commercial kitchen ventilation systems. It prescribes the use of cooking activity sensors, such as duct temperature sensors, smoke detectors, and infrared sensors.

Attention must be given to the design of appliance exhaust hoods, the location of cooking appliances, and the proximity of the make-up air intake vents to ensure compliance with other requirements that apply to commercial kitchens.

A-5.2.5.2.(1) Provision for Balancing. Balancing a hydronic system is a means of fine-tuning it so that the correct amount of fluid for which the system is designed can be delivered to each of the sectors served. Pumps and major circuit divisions must be installed with adequate access to the fluid to measure differential pressure or flow, and must be equipped with a means of adjusting the flow.

The following publications are useful sources of information on hydronic systems:

- ANSI/ASHRAE 111, “Testing, Adjusting, and Balancing of Building HVAC Systems”
- the ASHRAE Handbooks
- publications by the National Environmental Balancing Bureau

A-5.2.5.3.(1) Other Considerations. The required minimum thicknesses of insulation do not take into consideration water vapour transmission and condensation, burn protection, and severe climatic conditions; additional insulation, vapour barriers, or both, may be required to limit these.

A-5.2.6.2.(1) Variable-Flow Pumping Systems. Flow may be varied by one of several methods such as variable-speed-driven pumps, staged multiple pumps or pumps riding their characteristic performance curves, etc. Sentence 5.2.6.2.(1) reduces the use of three-way valves.

A-5.2.8.3.(1) Occupancy Controls and Set-back Temperature.

Occupancy Controls

Examples of occupancy controls that could be used to meet the requirement of Sentence 5.2.8.3.(1) include, but are not limited to, captive key systems (or key-card systems) and infra-red, ultrasonic or microwave motion-sensing systems.

Set-back Temperature

The set-back temperature should be determined using good engineering practice such as that described in ANSI/ASHRAE 55, "Thermal Environmental Conditions for Human Occupancy."

A-5.2.8.4.(1) Mounting Height and Location of Thermostats.

Mounting Height of Thermostats

Article 3.8.3.8. of Division B of the NBC contains a specific requirement regarding the mounting height of thermostats located in a barrier-free path of travel; the use of thermostats with separate sensors and controls may be the best option in such spaces.

Location of Thermostats

Examples of locations to be avoided are exterior walls and locations near exterior entrances, corners and within throw of supply air diffusers. Installation should include all necessary settings and adjustments, including, in the case of electric heaters, setting of the heat anticipator to match the capacity of the heaters being controlled, as required on some thermostats for performance certification.

A-5.2.8.5.(1) and 5.2.11.1.(2)(e) Supplementary Heater. For the purposes of Sentence 5.2.8.5.(1) and Clause 5.2.11.1.(2)(e), "supplementary" heat or heater refers to the provision of heat over and above the capacity of the heat pump in order to meet peak heating load demand.

A-5.2.8.6.(2)(a) Thermostatic Controls for Perimeter Systems. Clause 5.2.8.6.(2)(a) is intended to prohibit the use of an outdoor sensor as the sole control that determines the heat supplied to a space. However, a single-zone thermostat is permitted to be used to measure the radiation for each building exposure as input to control the heat supplied to the perimeter system.

A-5.2.8.6.(3) Heating and Cooling Controls. The requirement in Sentence 5.2.8.6.(3) can be met by means of software in a direct digital control system, or through the provision of a concealed, adjustable mechanical stop in each thermostat.

A-5.2.8.8.(2) Reheating Supply Air for Humidity Control. Sentence 5.2.8.8.(2) could apply to spaces such as computer rooms, operating rooms and museums. Theatres often require reheating since the cooling coil discharge temperature necessary to maintain reasonable humidity levels is too low for adequate comfort conditions.

A-5.2.8.9.(4) Minimum Airflow Rate to a Temperature-Control Zone. In addition to the reduction in airflow rate referred to in Sentence 5.2.8.9.(4), the minimum airflow rate may also be dictated by considerations in other applicable codes or accreditation standards, such as air pressure relationships or minimum air change rates.

A-5.2.10.1.(1) Energy Recovery Systems. Energy recovery systems use technologies such as glycol run-around systems, heat pipes, air-to-air heat exchangers, and heat or enthalpy wheels. Each technology has its own advantages so selecting the most suitable type of energy recovery system for a particular exhaust air system will depend on the HVAC system's application, the ratio of exhaust/relief air volumes to supply air volumes, potential for cross-contamination of the exhaust/relief airstream, exhaust air recirculation, and the incoming ventilation airstream, as well as the energy recovery system's effectiveness, which is typically stated in the system's specifications.

A-5.2.10.1.(4) Energy Recovery Effectiveness. The equation in Sentence 5.2.10.1.(4) is reproduced from ASHRAE/IES 90.1, "User's Manual." In AHRI 1061 (SI), "Performance Rating of Air-to-Air Exchangers for Energy Recovery Ventilation Equipment," the corresponding variables are referred to as follows:

- $h_{OA \text{ entering}}$: Entering Supply Airflow, Station 1, and X_1
- $h_{OA \text{ leaving}}$: Leaving Supply Airflow, Station 2 and X_2
- h_{RA} : Entering Exhaust Airflow, Station 3 and X_3

A-5.2.10.1.(6) Energy Recovery System Controls. The operation of energy recovery systems should not entail the unnecessary operation of mechanical heating and cooling systems. Similarly, where HVAC systems incorporate air economizer systems, as described in Article 5.2.2.8., the energy recovery systems should be equipped with controls and/or equipment that allow the air economizers to operate optimally without requiring additional heating or cooling. This is commonly accomplished through the addition of face and by-pass dampers across the energy recovery system.

A-5.2.10.2.(1) Heat Recovery from Dehumidification in Swimming Pools. Sentence 5.2.10.2.(1) is not intended to require that all exhaust air from the swimming pool area pass through a heat-recovery unit, only sufficient air to recover 40% of the total sensible heat. Most heat-recovery units can recover more than 40% of the sensible heat from the exhaust air, but because it may not be cost-effective to reclaim heat from all exhaust systems, the overall recovery requirement is set at 40%.

A-5.2.10.3.(1) Heat Recovery from Ice-making Machines in Ice Arenas and Curling Rinks. Heat recovered from refrigeration equipment can also be used for ice resurfacing or heating the soil beneath the ice's surface to prevent frost heave.

A-5.2.10.4.(1) Heat Recovery in Dwelling Units. The NBC contains detailed requirements for the mechanical ventilation of dwelling units. As the NECB only addresses the objective of energy efficiency, requirements that address other objectives can be found in the NBC and NPC. Therefore, the requirements of this Code should be read in conjunction with those of the NBC. For example, the requirements of Subsection 9.32.3. of Division B of the NBC can be satisfied using a heat-recovery ventilator but can also be satisfied with other types of ventilation equipment. In cases where the NECB requires heat recovery from the exhaust component of the ventilation system, a heat-recovery ventilator is often the most likely choice.

Article 9.32.3.4. of Division B of the NBC describes the principal exhaust component of a mechanical ventilation system, which represents 50% of the total ventilation capacity required by Article 9.32.3.3. of that Code.

A-5.2.10.4.(2) Heat-Recovery Ventilators. CAN/CSA-C439, "Laboratory methods of test for rating the performance of heat/energy-recovery ventilators," describes a laboratory test that determines the energy performance of a heat-recovery ventilator. Test results for many models are listed in HVI's "Certified Home Ventilating Products Directory." The results also usually appear on a label on the equipment itself or in the manufacturer's published literature.

Sentence 5.2.10.4.(2) is not intended to preclude the use of energy-recovery ventilators (ERVs).

A-5.2.10.4.(5) Heat-Recovery Ventilators in Multi-Unit Residential Buildings. Heat-recovery ventilators used in multi-unit residential buildings must not allow any cross-contamination of airflow from one dwelling unit to another as per the NBC. The minimum sensible-heat-recovery efficiency can be calculated in accordance with ASHRAE/IES 90.1, "User's Manual."

A-5.2.11.1.(1) Off-hours Controls. For a system serving only a single dwelling unit, one way to satisfy Sentence 5.2.11.1.(1) is to use an automatic programmable thermostat that permits automatic setback of the thermostat setpoint. For larger buildings with more than one system, a central control is recommended.

A-5.2.11.1.(2)(d) Reducing or Shutting off Outdoor Air Intake. Setback and morning startup periods are examples of periods when outdoor air intake may be reduced or shut off.

A-5.2.11.1.(2)(e) Heat Pump Controls for Recovery from Setback. The requirements of Clause 5.2.11.1.(2)(e) can be achieved through several methods:

- (a) installation of a separate exterior temperature sensor,
- (b) setting a gradual rise of the control point, or
- (c) installation of controls that "learn" when to start recovery based on stored data.

A-5.2.11.2.(3) Temperature Control for Airflow Control Areas. All of the zones in a building should not have to be conditioned when only some of them are occupied. At the very least, each floor should be able to be isolated; where the floor surface area exceeds 2 500 m², it should be divided into areas no greater than 2 500 m².

A-5.2.12.1.(1) Unitary and Packaged HVAC Equipment. Units of equipment subject to federal, provincial or territorial appliance or equipment energy efficiency acts carry a label certifying that their performance meets the requirements of the standard and acts shown thereon; there is therefore no need for figures to be checked.

In cases where third-party certification is not feasible (due to the absence or limitations of certification programs or testing facilities), the equipment's performance is usually demonstrated with data that is obtained in accordance with the referenced testing standard and supplied by the manufacturer.

It should be noted that, where a building is served by multiple heating or cooling units that are activated in sequence in response to increasing heating or cooling needs, it is likely economically justified to specify higher efficiency than is mandated in this Code for the lead units, which operate for the longest periods of time.

A-5.2.12.1.(1) and 6.2.2.1.(1) Performance Requirements and Levels.

Performance Requirements

HVAC and service water heating equipment standards are reviewed and updated on a regular basis, whereas the "Energy Efficiency Regulations" are revised or updated to include new types of equipment at irregular intervals. The regulations follow a legislative protocol prior to becoming a federal requirement. This means that the publication of revisions to these documents does not always coincide with the publication of a new edition of the Code. As such, the performance requirement of any equipment or component in Tables 5.2.12.1.-A to 5.2.12.1.-P and 6.2.2.1. can change without notice between Code cycles.

Performance Levels

The federal "Energy Efficiency Act," which was introduced in 1992, provides for the development and enforcement of regulations concerning minimum energy performance levels for energy-using products and products that affect energy use, as well as the labeling of energy-using products and the collection of data on energy use.

The "Energy Efficiency Regulations," which came into effect in 1995, establish energy efficiency standards for a wide range of energy-using products imported into Canada or manufactured in Canada with the objective of eliminating the least energy-efficient products from the Canadian market. They set test procedures and require that each product carry a verification mark from a product certification body accredited by the Standards Council of Canada, which certifies that the product's energy performance is in compliance with the Regulations' energy efficiency standard for that type of product. The Regulations are amended on a regular basis in accordance with the federal government's regulatory process; a summary of the current Regulations is available at www.nrcan.gc.ca/energy-efficiency/energy-efficiency-regulations/guide-canadas-energy-efficiency-regulations/6861.

A-5.2.12.2.(1) Heat Rejection Equipment. Standalone heat rejection equipment refers to equipment, such as cooling towers, fluid coolers and condensers, which can be categorized as follows:

- "Direct-contact" refers to equipment where the heat transfer fluid is in direct contact with the atmosphere. Heat rejection to the environment is mainly realized by partial evaporation of water (the heat transfer fluid). This is typical of most cooling towers where water is circulated in an open loop.
- "Indirect-contact" (also called "closed-circuit") refers to equipment where the heat transfer fluid circulates in a heat exchanger thus separating it from the atmosphere. There is no evaporation of the heat transfer fluid. This is typical of most refrigerant condensers and liquid coolers where the heat transfer fluid is circulated in a closed loop.
- "Evaporative" refers to indirect-contact equipment whose heat rejection capacity is enhanced during warm weather by spraying water on the air-side of the heat exchanger. The heat rejection capacity of the equipment is increased due to the partial evaporation of the water circulated in an open-loop. During cold weather, the water spray is stopped and the equipment operates as strictly air-cooled. This is typical of indirect-contact cooling towers and evaporative condensers.
- "Air-cooled" refers to indirect-contact equipment where heat rejection is realized by passing air over the heat exchanger, which cools or condenses the heat transfer fluid. This is typical of most condensers and liquid coolers.

Division B

Part 6 Service Water Systems

6.1.	General	
6.1.1.	General	6-1
6.2.	Prescriptive Path	
6.2.1.	System Design	6-1
6.2.2.	Water Heating Equipment and Storage Vessels	6-1
6.2.3.	Piping	6-5
6.2.4.	Controls	6-6
6.2.5.	Systems with More Than One End Use Design Temperature	6-7
6.2.6.	Hot Service Water	6-7
6.2.7.	Swimming Pools	6-7
6.2.8.	Pressure Booster Systems	6-8
6.3.	Reserved	
6.4.	Performance Path	
6.4.1.	General	6-8
6.5.	Objective and Functional Statements	
6.5.1.	Objective and Functional Statements	6-8
	Notes to Part 6	6-11

Division B

Part 6 Service Water Systems

Section 6.1. General

6.1.1. General

6.1.1.1. Scope

1) This Part is concerned with the systems used to heat *service water* and with pumping systems that are part of *service water* systems.

6.1.1.2. Application

1) Except for systems and equipment used exclusively for firefighting services, this Part applies to *service water* heating and pumping systems.

6.1.1.3. Compliance

1) Except as provided in Sentence (2), compliance with this Part shall be achieved by following

- a) the prescriptive path described in Section 6.2., or
- b) the performance path described in Section 6.4. (see Note A-3.1.1.3.(1)(c)).

(See Note A-6.1.1.3.(1).)

2) Back-up systems shall comply with the prescriptive requirements stated in Section 6.2.

6.1.1.4. Definitions

1) Words that appear in italics are defined in Article 1.4.1.2. of Division A.

Section 6.2. Prescriptive Path

6.2.1. System Design

6.2.1.1. Regulations

1) *Service water* systems shall be designed in accordance with the relevant provincial, territorial or municipal *building* regulations or, in the absence of such regulations, or where *service water* systems are not covered by such regulations, with the NPC.

6.2.2. Water Heating Equipment and Storage Vessels

6.2.2.1. Equipment Efficiency

1) *Service water* heaters and pool heaters with the capacities listed in Table 6.2.2.1. shall comply with the performance requirements stated therein. (See Notes A-6.2.2.1.(1) and A-5.2.12.1.(1) and 6.2.2.1.(1).)

Table 6.2.2.1.
Service Water Heating Equipment Performance Requirements
 Forming Part of Sentences 5.2.12.4.(1), 6.2.2.1.(1), 6.2.2.4.(2) and 6.2.2.5.(1)

Type of Equipment	Input Power	Rated Storage Capacity (V _s), L	Volume of Tank (V _s), L	Input/V _s , W/L	Performance Testing Standard	Rating Conditions ⁽¹⁾	Performance Requirement ^{(2),(3)}
Electric-Powered Service Water Heaters							
Storage-type ⁽⁴⁾	≤ 12 kW	≥ 50 and ≤ 270	—	—	CAN/CSA-C191	Bottom inlet	SL ≤ 40 + (0.2 V _r)
		> 270 and ≤ 454	—	—		Top inlet	SL ≤ 35 + (0.2 V _r)
	> 12 kW	—	—	—	CSA/ANSI Z21.10.3/CSA 4.3 ⁽⁵⁾ or DOE 10 CFR, Part 431, Subpart G, Appendix B	Bottom inlet	SL ≤ (0.472 V _r) – 33.5
		—	—	—		Top inlet	SL ≤ (0.472 V _r) – 38.5
Storage-type, heat pump	≤ 24 A and ≤ 250 V	—	—	—	CAN/CSA-C745	ΔT = 44.4°C	SL ≤ 0.3 + 102.2V _r
Instantaneous	—	—	—	—	—	—	EF ≥ 2.1
Fuel-Fired Service Water Heaters							
Gas-fired, storage-type ⁽⁴⁾⁽⁷⁾	≤ 22 kW	—	≥ 76 and < 208	—	CAN/CSA-P3	FHR < 68	UEF ≥ 0.3456 – (0.00053 V _s)
						68 ≤ FHR < 193	UEF ≥ 0.5982 – (0.00050 V _s)
		193 ≤ FHR < 284	UEF ≥ 0.6483 – (0.00045 V _s)				
		FHR ≥ 284	UEF ≥ 0.6920 – (0.00034 V _s)				
		FHR < 68	UEF ≥ 0.6470 – (0.00016 V _s)				
	> 22 kW and ≤ 30.5 kW	—	≥ 208 and < 380	—	CAN/CSA-P3	68 ≤ FHR < 193	UEF ≥ 0.7689 – (0.00013 V _s)
						193 ≤ FHR < 284	UEF ≥ 0.7897 – (0.00011 V _s)
						FHR ≥ 284	UEF ≥ 0.8072 – (0.00008 V _s)
	All others	≤ 454	—	—	CAN/CSA-P3	All values of FHR	UEF ≥ 0.8107 – (0.00021 V _s)
		—	—	—	DOE 10 CFR, Part 431, Subpart G, Appendix A	ΔT = 50°C	E _t ≥ 90% SL ≤ 0.84 [(1.25 Q) + (16.57 √V _r)]
Gas-fired, instantaneous ⁽⁴⁾⁽⁷⁾⁽⁸⁾	< 59 kW	≤ 7.6	—	≥ 310	CAN/CSA-P3	< 6.4 L/min	UEF ≥ 0.86
						≥ 6.4 L/min	UEF ≥ 0.87
All others	—	—	—	—	DOE 10 CFR, Part 431, Subpart G, Appendix C	—	E _t ≥ 94%

Table 6.2.2.1. (Continued)

Type of Equipment	Input Power	Rated Storage Capacity (V _s), L	Volume of Tank (V _s), L	Input/V _s , W/L	Performance Testing Standard	Rating Conditions ⁽¹⁾	Performance Requirement ⁽²⁾⁽³⁾
Oil-fired, storage-type ⁽⁴⁾	≤ 30.5 kW	> 76	—	—	CAN/CSA-B211	—	EF ≥ 0.68 – (0.0005 V _t)
	> 30.5 kW and ≤ 41 kW	≤ 454	—	< 310	CAN/CSA-P3	FHR < 68	UEF ≥ 0.2509 – (0.00032 V _s)
	All others	—	—	—		68 ≤ FHR < 193	UEF ≥ 0.5330 – (0.00042 V _s)
Oil-fired, instantaneous ⁽⁴⁾	≤ 61.5 kW	—	—	—	DOE 10 CFR, Part 431, Subpart G, Appendix A	193 ≤ FHR < 284	UEF ≥ 0.6078 – (0.00042 V _s)
	All others	—	< 37.8	≥ 310	DOE 10 CFR, Part 430, Subpart B, Appendix E	FHR ≥ 284	UEF ≥ 0.6815 – (0.00037 V _s)
	—	—	≥ 37.8	—	DOE 10 CFR, Part 431, Subpart G, Appendix A	All values of FHR	UEF ≥ 0.6740 – (0.00035 V _s)
Solar Thermal Service Water Heaters							
With electric back-up	All capacities	—	—	—	ICC 900/SRCC 300	See standard	SEF ≥ 1.4
With gas-fired back-up ⁽⁷⁾	—	—	—	—	—	—	SEF ≥ 0.9
Pool Heaters							
Gas-fired ⁽⁷⁾	< 117.2 kW	—	—	—	CSA/ANSI Z21.56/CSA 4.7 or CSA P6	See standard	E _t ≥ 82%
Oil-fired	—	—	—	—	CSA B140.12	—	E _t ≥ 78%
Heat pump	All values	—	—	—	AHRI 1160 (I-P)	Outdoor air 10°C db / 6.8°C wb 26.7°C entering water	4.0 COP

Notes to Table 6.2.2.1.:

(1) The symbols and abbreviations used in this column have the following meanings:

- db = dry-bulb outdoor air temperature
- FHR = first-hour rating: the amount of hot service water supplied within the first hour, in L
- ΔT = difference in temperature of water from inlet versus water from outlet of water heater
- wb = wet-bulb outdoor air temperature

(2) The symbols and abbreviations used in this column have the following meanings:

- COP = coefficient of performance
- E_t = thermal efficiency with a 38.9°C (70°F) water temperature difference
- EF = energy factor
- Q = rated input, in kW
- SEF = solar energy factor: a normalized ratio of energy output over energy consumption (only electricity or fuel input) over a 24-h period
- SL = standby losses, in %/h or in W, depending on which testing standard is used

6.2.2.1.

Table 6.2.2.1. (Continued)

UEF	= uniform energy factor
V_r	= rated volume, as specified by the manufacturer
V_s	= volume of tank, as measured in accordance with the listed test standard, in L
(3)	Where more than one performance requirement applies to a given type/capacity/size combination, the equipment must comply with at least one of them.
(4)	Components or equipment regulated in the "Energy Efficiency Regulations" at the time of publication of the Code (see Article 1.1.3. of Division A).
(5)	When testing an electric <i>storage-type service water heater for standby losses</i> using the test procedure described in the referenced standard, the electrical supply voltage shall be maintained within $\pm 1\%$ of the centre of the voltage range specified on the water heater nameplate. Also, when needed for calculations, the <i>thermal efficiency</i> (E_t) shall be 98%.
(6)	No standards address the performance efficiency of electric instantaneous <i>service water heaters</i> ; however, their efficiency typically approaches 100%.
(7)	Includes propane.
(8)	See also Article 6.2.2.3.

6.2.2.2. Equipment Insulation

- 1) Except for tanks covered by Article 6.2.2.1., hot *service water* storage tanks shall be covered with insulation having a maximum U-value of $0.45 \text{ W}/(\text{m}^2 \times \text{K})$.
- 2) Tank insulation referred to in Sentence (1) that is installed in areas where it may be subject to mechanical damage shall be protected.

6.2.2.3. Solar Thermal Service Water Heating Equipment

- 1) *Service water* heating equipment using solar thermal technology shall be designed and installed in accordance with
 - a) the manufacturer's procedures, or
 - b) CAN/CSA-F379 SERIES, "Packaged solar domestic hot water systems (liquid-to-liquid heat transfer)."

6.2.2.4. Combination Service Water Heating and Space-Heating Equipment

- 1) Combination *service water* heating and space-heating equipment is only permitted to be used where input to the combination equipment is
 - a) less than 22 kW, or
 - b) less than twice the design *service water* heating load.
- 2) Where combination equipment referred to in Sentence (1) is used, its performance shall meet the greater of the minimum energy efficiency ratings for *service water* heating equipment and space-heating equipment required in the applicable standards listed in Tables 5.2.12.1.-A to 5.2.12.1.-P and 6.2.2.1. or, where such equipment is not covered in these Tables, with the "Energy Efficiency Act" and the "Energy Efficiency Regulations."

6.2.2.5. Space-Heating Equipment Used for Indirect Service Water Heating

- 1) Space-heating equipment used solely to provide indirect *service water* heating or used to provide a combination of space heating and indirect *service water* heating shall meet the greater of the minimum energy efficiency ratings for *service water* heating equipment and space-heating equipment required in the applicable standards listed in Tables 5.2.12.1.-A to 5.2.12.1.-P and 6.2.2.1. or, where such equipment is not covered in these Tables, with the "Energy Efficiency Act" and the "Energy Efficiency Regulations."

6.2.3. Piping**6.2.3.1. Insulation**

- 1) All piping conveying hot *service water* in circulating systems, non-circulating systems without *heat traps* and non-circulating systems with electric heating elements along the pipes to maintain temperature shall be insulated in accordance with Table 6.2.3.1. and Sentences (2) to (4). (See Note A-6.2.3.1.(1).)
- 2) Where piping insulation has a thermal conductivity, as determined in accordance with Sentence (4), that is greater than the range given in Table 6.2.3.1., the thickness given in the Table shall be increased by the ratio u_2/u_1 , where u_1 is the value at the higher end of the conductivity range for the operating temperature and u_2 is the measured thermal conductivity of the insulation at the mean rating temperature. (See Note A-6.2.3.1.(2) and (3).)
- 3) Where piping insulation has a thermal conductivity, as determined in accordance with Sentence (4), that is lower than the range given in Table 6.2.3.1., the thickness given in the Table may be decreased by the ratio u_2/u_1 , where u_1 is the value at the lower end of the conductivity range for the operating temperature and u_2 is the measured thermal conductivity of the insulation at the mean rating temperature. (See Note A-6.2.3.1.(2) and (3).)
- 4) The thermal conductivity of piping insulation at the mean rating temperature shall be determined in conformance with ASTM C335/C335M, "Standard Test Method for Steady-State Heat Transfer Properties of Pipe Insulation."

5) On non-circulating systems with *heat traps*, the inlet and outlet piping between the storage or heating vessel and the *heat traps* as well as the first 2.4 m of outlet piping downstream of the *heat trap* shall be insulated in accordance with Table 6.2.3.1. and Sentences 5.2.5.3.(4) to (6).

6) The insulation thickness used to determine compliance with Table 6.2.3.1. shall be the thickness of the insulation after installation. (See Note A-5.2.2.5.(2), 5.2.5.3.(8) and 6.2.3.1.(6).)

7) Insulation on piping conveying hot *service water* that is installed in areas where it may be subject to mechanical damage or weathering shall be protected.

8) Manufactured insulation thicknesses shall not be altered.

Table 6.2.3.1.
Minimum Thickness of Piping Insulation for Service Water Heating Systems
Forming Part of Sentences 6.2.3.1.(1) to (3), (5) and (6)

Location of Piping	Thermal Conductivity of Insulation		Nominal Pipe Diameter, mm (in.)	Minimum Thickness of Piping Insulation, ⁽¹⁾ mm
	Conductivity Range, W/m×°C	Mean Rating Temperature, °C		
Conditioned space	0.035–0.040	38	Runouts ⁽¹⁾ ≤ 51 (2)	25.4
			≤ 25.4 (1)	
			32 to 51 (1¼ to 2)	38.1
			64 to 102 (2½ to 4)	
≥ 127 (5)				
Unconditioned space or outside	0.046–0.049	38	Runouts ⁽¹⁾ ≤ 51 (2)	38.1
			≤ 25.4 (1)	63.5
			32 to 51 (1¼ to 2)	76.2
			64 to 102 (2½ to 4)	88.9
			≥ 127 (5)	

Notes to Table 6.2.3.1.:

⁽¹⁾ The stated thicknesses apply to recirculating sections of *service water* heating systems and to the first 2.4 m from storage tanks for non-recirculating systems.

6.2.4. Controls

6.2.4.1. Temperature Controls

1) *Service water* heating systems with storage tanks shall be equipped with automatic temperature controls capable of adjustment between the lowest and the highest acceptable temperature settings for the intended use. (See Note A-6.2.4.1.(1).)

6.2.4.2. Shutdown

1) Except for systems whose storage capacity is less than 100 L, each *service water* heating system shall be equipped with a readily accessible and clearly labeled shut-off device that allows the system, including any heating elements installed along the pipes to maintain temperature, to be shut-off. (See Note A-6.2.4.2.(1).)

6.2.4.3. Maintaining Temperature of Hot Service Water

1) Heating elements installed along *service water* heating system pipes to maintain the water temperature shall incorporate automatic controls that maintain the temperature of the hot water within the range required for the intended use.

6.2.5. Systems with More Than One End Use Design Temperature**6.2.5.1. Remote or Booster Heaters**

1) Where less than 50% of the total design flow of a *service water* heating system has a design discharge temperature higher than 60°C, separate remote heaters or booster heaters shall be installed for those portions of the system with a design temperature higher than 60°C. (See Note A-6.2.5.1.(1).)

6.2.6. Hot Service Water**6.2.6.1. Showers**

1) Except for emergency eye washes and emergency showers, individual shower heads shall have an integral means of limiting the maximum water flow rate to 7.6 L/min when tested in accordance with ASME A112.18.1/CSA B125.1, "Plumbing Supply Fittings." (See Note A-6.2.6.1.(1).)

2) Where multiple shower heads installed in a public showering facility are served by one temperature control, each shower head shall be equipped with a device capable of automatically shutting off the flow of water when the showerhead is not in use. (See Note A-6.2.6.1.(2) and 6.2.6.2.(2).)

6.2.6.2. Lavatories

1) Except for lavatories in healthcare facilities and emergency eye washes, lavatories shall have an integral means of limiting the maximum water flow rate to 5.7 L/min for private use and 1.9 L/min for public use, when tested in accordance with ASME A112.18.1/CSA B125.1, "Plumbing Supply Fittings."

2) Each lavatory in a public access washroom in a *building of assembly occupancy* shall be equipped with a device capable of automatically shutting off the flow of water when the lavatory is not in use. (See Note A-6.2.6.1.(2) and 6.2.6.2.(2).)

6.2.7. Swimming Pools**6.2.7.1. Controls**

1) Pool heaters shall be equipped with a readily accessible and clearly labeled device that allows

- the heater to be shut off without adjusting the thermostat setting, and
- where applicable, the heater to be restarted without manually relighting the pilot light.

2) Except for pool pumps required by public health standards to operate on a 24-h basis, swimming pool pumps and swimming pool heaters shall be equipped with time switches or other controls that can be set to automatically turn off the pumps and heaters when their operation is not required.

6.2.7.2. Pool and Hot Tub Covers

1) Heated outdoor swimming pools and tubs shall be equipped with covers capable of covering at least 90% of the water surface.

2) Where pools or tubs are heated to a temperature above 32°C, the covers described in Sentence (1) shall have a nominal thermal transmittance of no more than 0.48 W/m²×°C.

6.2.8.1.**6.2.8. Pressure Booster Systems****6.2.8.1. Size of Water Storage Tank**

(See Note A-6.2.8.1.)

1) Constant-speed pressure booster systems shall be provided with a hydro-pneumatic storage tank sized to store a volume of water corresponding to at least 1 min of operation at the system's design flow rate and pressure.

2) Variable-speed pressure booster systems shall be provided with a hydro-pneumatic storage tank sized to store a volume of water corresponding to at least 1 min of operation at 10% of the system's design flow rate and pressure.

6.2.8.2. Pressure Control

1) Pressure booster systems shall be provided with at least one pressure sensor that starts and stops the system or varies the pump speed so that the pressure required for operation of the *service water* system is maintained. (See Note A-6.2.8.2.(1).)

2) Except for safety devices, pressure-reducing devices shall not be installed on a pressure booster system.

Section 6.3. Reserved**Section 6.4. Performance Path**

(See Note A-1.1.2.1.)

6.4.1. General**6.4.1.1. Scope**

1) Subject to the limitations stated in Article 6.4.1.2., where the *service water* heating system does not comply with the requirements of Section 6.2., it shall comply with Part 8.

6.4.1.2. Limitations

1) Notwithstanding use of the performance path, all *service water* heating appliances and equipment shall comply with the applicable appliance or equipment energy efficiency act or, in the absence of such an act or where the appliance or equipment is not covered by such an act, with the applicable performance standard.

2) This Section does not apply to back-up SWH systems, which shall comply with Sentence 6.1.1.3.(2).

Section 6.5. Objective and Functional Statements**6.5.1. Objective and Functional Statements****6.5.1.1. Attributions to Acceptable Solutions**

1) For the purpose of compliance with this Code as required in Clause 1.2.1.1.(1)(b) of Division A, the objective and functional statements attributed to the acceptable solutions in this Part shall be the objective and functional statements listed in Table 6.5.1.1. (See Note A-1.1.3.1.(1).)

Table 6.5.1.1.
Objectives and Functional Statements Attributed to the
Acceptable Solutions in Part 6
 Forming Part of Sentence 6.5.1.1.(1)

Provision	Functional Statements and Objectives ⁽¹⁾
6.2.1.1. Regulations	
(1)	[F96,F98-OE1.1]
6.2.2.1. Equipment Efficiency	
(1)	[F96,F98-OE1.1]
6.2.2.2. Equipment Insulation	
(1)	[F93,F96-OE1.1]
(2)	[F93,F96-OE1.1]
6.2.2.3. Solar Thermal Service Water Heating Equipment	
(1)	[F96,F98,F99-OE1.1]
6.2.2.4. Combination Service Water Heating and Space-Heating Equipment	
(1)	[F95,F96,F98,F99-OE1.1]
(2)	[F95,F96,F98,F99-OE1.1]
6.2.2.5. Space-Heating Equipment Used for Indirect Service Water Heating	
(1)	[F95,F96,F98,F99-OE1.1]
6.2.3.1. Insulation	
(1)	[F92,F93-OE1.1]
(2)	[F92,F93-OE1.1]
(4)	[F92,F93-OE1.1]
(5)	[F92,F93-OE1.1]
(6)	[F93,F96-OE1.1]
(7)	[F93,F96-OE1.1]
(8)	[F93,F95,F99-OE1.1]
6.2.4.1. Temperature Controls	
(1)	[F96-OE1.1]
6.2.4.2. Shutdown	
(1)	[F96-OE1.1]
6.2.4.3. Maintaining Temperature of Hot Service Water	
(1)	[F96-OE1.1]
6.2.5.1. Remote or Booster Heaters	
(1)	[F96-OE1.1]
6.2.6.1. Showers	
(1)	[F96-OE1.1]
(2)	[F96-OE1.1]
6.2.6.2. Lavatories	
(1)	[F96-OE1.1]
(2)	[F96-OE1.1]
6.2.7.1. Controls	
(1)	[F95,F96,F99-OE1.1]
(2)	[F95,F96,F99-OE1.1]

Table 6.5.1.1. (Continued)

Provision	Functional Statements and Objectives ⁽¹⁾
6.2.7.2. Pool and Hot Tub Covers	
(1)	[F95-OE1.1]
(2)	[F95-OE1.1]
6.2.8.1. Size of Water Storage Tank	
(1)	[F97,F99-OE1.1]
(2)	[F97,F99-OE1.1]
6.2.8.2. Pressure Control	
(1)	[F96,F97-OE1.1]
(2)	[F96,F97-OE1.1]
6.4.1.2. Limitations	
(1)	[F98,F99-OE1.1]

Notes to Table 6.5.1.1.:

(1) See Parts 2 and 3 of Division A.

Notes to Part 6 Service Water Systems

A-6.1.1.3.(1) Compliance. The flow chart in Figure A-6.1.1.3.(1) illustrates the process for the two paths of compliance applicable to Part 6.

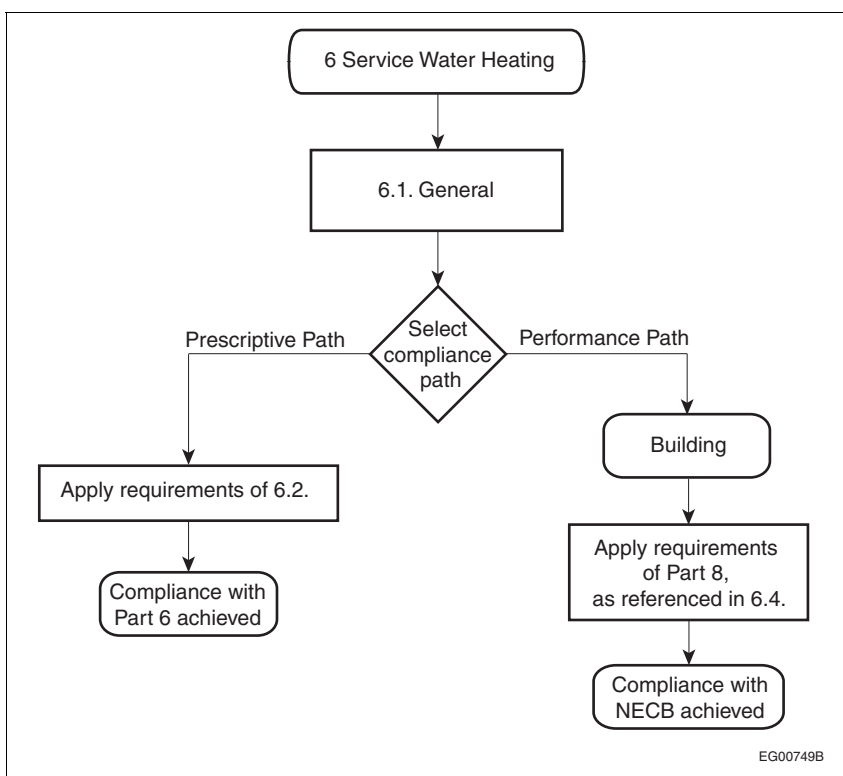

Figure A-6.1.1.3.(1)
Code compliance paths for service water heating

A-6.2.2.1.(1) Equipment Efficiency. Units of equipment subject to federal, provincial or territorial appliance or equipment energy efficiency acts carry a label certifying that their performance meets the standard shown thereon.

A-6.2.3.1.(1) Heat Traps. ASHRAE/IES 90.1, “User’s Manual,” defines a heat trap as follows:

“A heat trap is a device or arrangement of piping that keeps the buoyant hot water from circulating through a piping distribution system through natural convection. By restricting the flow from the storage tank, standby heat loss is minimized.

These Notes are included for explanatory purposes only and do not form part of the requirements. The number that introduces each Note corresponds to the applicable requirement in this Part.

Heat traps are required for storage heaters and storage tanks in non-circulating systems with vertical piping. Storage heaters with integral heat traps on both inlet and outlet piping satisfy this requirement. External heat traps must be insulated and should be placed as close as possible to the tank inlet and outlet fittings.

In all configurations heat traps can be a 360° loop of piping, a pre-manufactured device, or some arrangement of piping and elbows that forms an inverted “U” on the tank fittings. Tanks that have horizontal outlets need only a section of vertical pipe that turns downward after leaving the tank (an inverted “L”).”

Figure A-6.2.3.1.(1) illustrates two examples of site-built heat traps. An inlet pipe that feeds directly into the cold region of the tank may also be considered to have an effect equivalent to that of a heat trap.

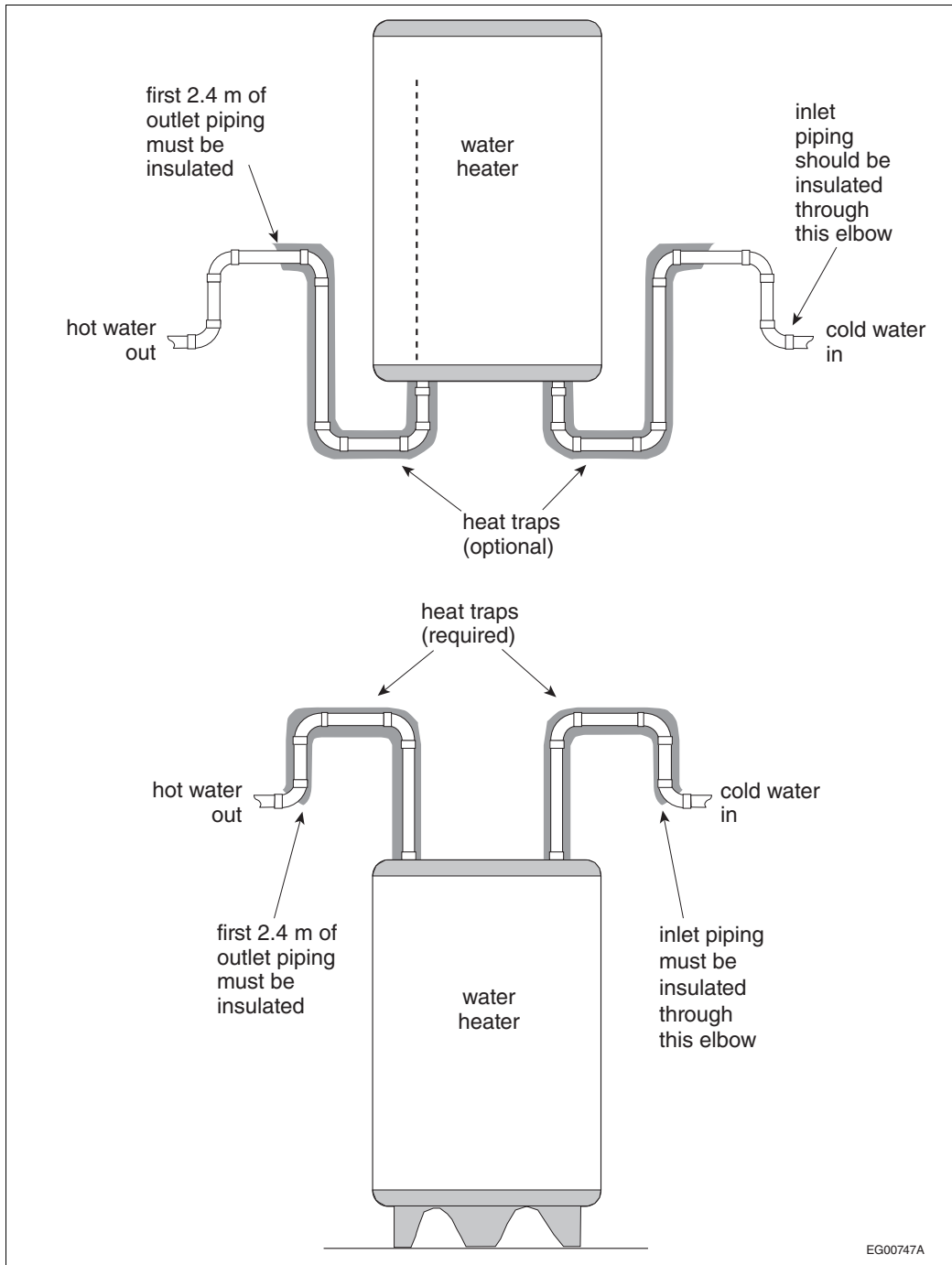

Figure A-6.2.3.1.(1)
Heat traps

A-6.2.3.1.(2) and (3) Mean Rating Temperature (MRT). The mean rating temperature can be determined using the following equation:

$$\text{MRT} = \frac{(T_{\text{ambient}} + T_{\text{operation}})}{2}$$

where

T_{ambient} = ambient temperature of room in which pipe is located, and
 $T_{\text{operation}}$ = temperature of service water being conveyed in pipe.

A-6.2.4.1.(1) Temperature Control. The temperatures applicable to various uses of service water can be found in the “ASHRAE Handbook – HVAC Applications.”

A-6.2.4.2.(1) Shutdown. Sentence 6.2.4.2.(1) is intended to apply to seasonal or long-term shutdown of the service water heating system. For electrical water heaters, a breaker approved for use as a disconnect and installed in the distribution panel can act as the required shut-off device. For gas water heaters, a down position on the temperature control, which sets the heater to standby with only the pilot light running, meets this requirement.

A-6.2.5.1.(1) Remote or Booster Heaters. Sentence 6.2.5.1.(1) applies to appliances that require very hot water for their purpose such as dishwashers, etc. The intent is that the general water supply temperature not be raised to meet the hot water requirements of such appliances.

A-6.2.6.1.(1) Flow-Restricting Shower Heads. A flow of 7.6 L/min is equivalent to 2.0 US gal/min.

To address concerns of thermal shock and scalding, refer to Sentence 2.2.10.6.(3) of Division B of the NPC, which deals with the matching of automatic compensating valves and showerheads.

A-6.2.6.1.(2) and 6.2.6.2.(2) Water Shut-off Devices. Examples of devices meeting the intent of Sentences 6.2.6.1.(2) and 6.2.6.2.(2) include occupant sensors and self-closing valves.

A-6.2.8.1. Sizing of Hydro-Pneumatic Storage Tanks. In order to prevent short-cycling of the pump in a pressure booster system during periods of low- to no-flow demand, pressure booster systems must be provided with a hydro-pneumatic storage tank capable of meeting a theoretical low service water demand during a minimum amount of time. Otherwise, the pressure booster system would have to run almost continuously in almost no-flow conditions to meet the smallest demand, such as the occasional flushing of a toilet in a residential high-rise building.

There are several industry-recognized ways to determine the volume of water that needs to be stored in the tank. They are typically based on the number of start-stop cycles per hour and the nominal capacity of the pressure booster system, or on the peak system demand rate multiplied by a number of minutes representing the length of time the system is not operating. These sizing methodologies tend to result in large tank sizes, which are more appropriate for constant-speed pressure booster systems where the principal objective is to avoid short-cycling in mid- to high-flow demand situations. The application of Sentence 6.2.8.1.(1) will typically result in the pressure booster system going through about 15 start-stop cycles per hour, which corresponds to a typical industry recommendation to avoid shortening the service life of the system's pump. It will also prevent constant-speed pressure booster systems from operating in low- or no-flow conditions for a significant amount of time, while avoiding short-cycling in mid- to high-demand periods.

Variable-speed pressure booster systems require a significantly smaller tank than constant-speed ones.

A-6.2.8.2.(1) Sensors for Pressure Booster Systems. Variable-speed pressure booster systems should have one or more pressure sensors located near the fixtures that set the required system pressure.

Division B

Part 7

Electrical Power Systems and Motors

7.1.	General	
7.1.1.	General	7-1
7.2.	Prescriptive Path	
7.2.1.	Electrical Distribution System	7-1
7.2.2.	Voltage Drop	7-2
7.2.3.	Transformers	7-2
7.2.4.	Electrical Motors	7-2
7.3.	Reserved	
7.4.	Performance Path	
7.4.1.	General	7-2
7.5.	Objective and Functional Statements	
7.5.1.	Objective and Functional Statements	7-2
	Notes to Part 7	7-5

Part 7

Electrical Power Systems and Motors

Section 7.1. General

7.1.1. General

7.1.1.1. Scope

1) This Part is concerned with electrical power systems and motors for the application listed in Article 7.1.1.2.

7.1.1.2. Application

1) This Part applies to the electrical power systems and motors that are connected to the *building's* electrical service. (See Note A-7.1.1.2.(1).)

7.1.1.3. Compliance

1) Compliance with this Part shall be achieved by following

- a) the prescriptive path described in Section 7.2., or
- b) the performance path described in Section 7.4. (see Note A-3.1.1.3.(1)(c)).

(See Note A-7.1.1.3.(1).)

7.1.1.4. Definitions

1) Words that appear in italics are defined in Article 1.4.1.2. of Division A.

Section 7.2. Prescriptive Path

7.2.1. Electrical Distribution System

7.2.1.1. Monitoring

(See Note A-7.2.1.1.)

1) Electrical distribution systems whose load-carrying capacity is greater than 250 kVA shall be designed to facilitate the installation of a means to monitor the electrical energy consumption of

- a) HVAC systems,
- b) *interior lighting*, and
- c) *exterior lighting*.

2) The electrical distribution systems of *buildings* with tenants or *dwelling units* shall have a means to separately monitor the electrical energy consumption of the total *building* and of each individual tenant or *dwelling unit*, excluding shared systems.

7.2.2.1.**7.2.2. Voltage Drop****7.2.2.1. Feeders**

1) Feeder conductors shall be sized for a maximum voltage drop of 2% at design load.

7.2.2.2. Branch Circuits

1) Branch circuit conductors shall be sized for a maximum voltage drop of 3% at design load.

7.2.3. Transformers**7.2.3.1. Transformer Selection**

- 1) Transformers shall conform to
 - a) CAN/CSA-C802.1, "Minimum efficiency values for liquid-filled distribution transformers,"
 - b) CAN/CSA-C802.2, "Test method and minimum efficiency values for dry-type transformers," or
 - c) CSA C802.3, "Minimum efficiency values for power transformers."

7.2.4. Electrical Motors**7.2.4.1. Efficiency**

1) Except for elevator motors and motors that are components of rated equipment, permanently wired polyphase motors serving the *building* shall have a nominal full-load motor efficiency not less than the minimum specified in CSA C390, "Test methods, marking requirements, and energy efficiency levels for three-phase induction motors."

Section 7.3. Reserved**Section 7.4. Performance Path**

(See Note A-1.1.2.1.)

7.4.1. General**7.4.1.1. Scope**

1) Where electrical power systems and motors do not comply with the requirements of Section 7.2., they shall comply with Part 8.

Section 7.5. Objective and Functional Statements**7.5.1. Objective and Functional Statements****7.5.1.1. Attributions to Acceptable Solutions**

1) For the purpose of compliance with this Code as required in Clause 1.2.1.1.(1)(b) of Division A, the objective and functional statements attributed to the acceptable solutions in this Part shall be the objective and functional statements listed in Table 7.5.1.1. (See Note A-1.1.3.1.(1).)

Table 7.5.1.1.
Objectives and Functional Statements Attributed to the
Acceptable Solutions in Part 7
 Forming Part of Sentence 7.5.1.1.(1)

Provision	Functional Statements and Objectives ⁽¹⁾
7.2.1.1. Monitoring	
(1)	[F97-OE1.1]
(2)	[F97-OE1.1]
7.2.2.1. Feeders	
(1)	[F99-OE1.1]
7.2.2.2. Branch Circuits	
(1)	[F99-OE1.1]
7.2.3.1. Transformer Selection	
(1)	[F97,F98-OE1.1]
7.2.4.1. Efficiency	
(1)	[F97,F98,F99-OE1.1]

Notes to Table 7.5.1.1.:

(1) See Parts 2 and 3 of Division A.

Division B

Notes to Part 7 Electrical Power Systems and Motors

A-7.1.1.2.(1) Application. Sentence 7.1.1.2.(1) is intended to apply to all electrical power systems and motors in or on the building or building site that are connected to the building's electrical service.

A-7.1.1.3.(1) Compliance. The flow chart in Figure A-7.1.1.3.(1) illustrates the process for the compliance paths applicable to Part 7.

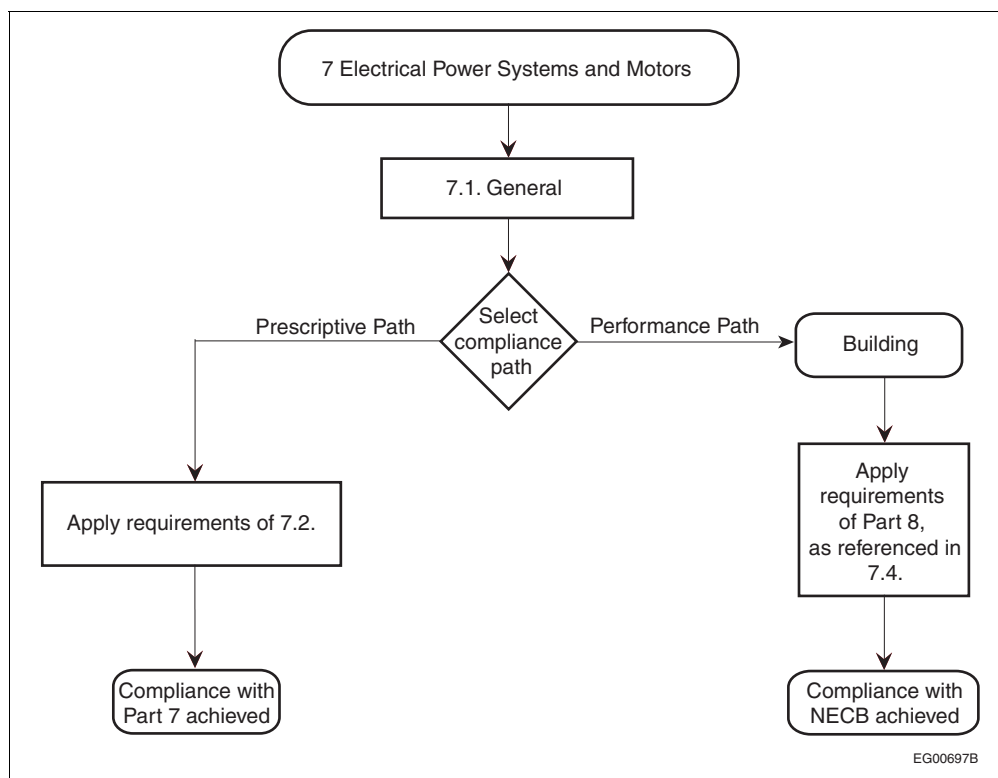

Figure A-7.1.1.3.(1)
Code compliance paths for electrical power systems and motors

These Notes are included for explanatory purposes only and do not form part of the requirements. The number that introduces each Note corresponds to the applicable requirement in this Part.

A-7.2.1.1.

A-7.2.1.1. Means to Monitor Energy Consumption. Monitoring electrical energy consumption is considered essential to energy management. However, Article 7.2.1.1. is not intended to require the installation of electrical energy consumption monitoring equipment but rather to require the provision of the necessary access and hardware to permit the eventual installation and use of monitoring equipment, if desired. This might include, for example, the installation of a meter socket or the provision of access to the load side of the service box or main distribution panel to allow for the measurement of energy consumption using voltage and/or current transformers on a separately mounted meter or data logger. Requirements for safe access to metering locations are provided in local electrical codes and in the “Canadian Electrical Code, Part I,” published by CSA.

Division B

Part 8 Building Energy Performance Compliance Path

8.1.	General	
8.1.1.	General	8-1
8.2.	Reserved	
8.3.	Reserved	
8.4.	Performance Path	
8.4.1.	Compliance	8-2
8.4.2.	Compliance Calculations	8-3
8.4.3.	Annual Energy Consumption of Proposed Building	8-6
8.4.4.	Building Energy Target of the Reference Building	8-8
8.4.5.	Part-Load Performance Characteristics	8-21
8.5.	Objective and Functional Statements	
8.5.1.	Objective and Functional Statements	8-32
	Notes to Part 8	8-37

Part 8

Building Energy Performance Compliance Path

Section 8.1. General

8.1.1. General

8.1.1.1. Scope

- 1) Compliance with this Code is permitted to be achieved by applying the provisions of this Part in lieu of
 - a) the prescriptive requirements in Sections 3.2., 4.2., 5.2., 6.2. and 7.2., or
 - b) the trade-off provisions in Sections 3.3. and 4.3.(See Note A-1.1.2.1.)

8.1.1.2. Application

- 1) This Part applies only to *buildings*
 - a) whose *occupancy* is known, and
 - b) except as provided in Sentence (2), for which sufficient information is known about their components, materials and assemblies that are covered by the scope of this Code.
- 2) Where insufficient information is known about the *building's* components, materials and assemblies, the applicable prescriptive requirements in Sections 3.2., 4.2., 5.2., 6.2. and 7.2. shall apply.
- 3) If, during construction, the design is found to be altered from the one used in the original performance assessment, the *building* shall be reassessed for compliance with this Part.
- 4) Except as provided in Sentence (5), the procedures stated in this Part shall be applied to a single *building* at a time.
- 5) Where the structure is divided by *firewalls* into multiple *buildings*, the whole structure is permitted to be treated as one *building*.

8.1.1.3. Definitions

- 1) Words that appear in italics are defined in Article 1.4.1.2. of Division A.

Section 8.2. Reserved

Section 8.3. Reserved

Section 8.4. Performance Path

8.4.1. Compliance

8.4.1.1. General

1) In establishing the *building energy target*, *building* components must be accounted for in accordance with the prescriptive requirements of Sections 3.2., 4.2., 5.2., 6.2. and 7.2. for the climate zone under consideration.

2) Where the construction techniques or *building* components used are more energy-efficient than those prescribed by the prescriptive requirements, the performance compliance calculations are permitted to take this increased performance level into account in the determination of the *annual energy consumption*, provided it can be quantified and is not dependent on occupant behaviour.

3) *Exterior lighting* is permitted to be excluded from the performance compliance calculations, provided it complies with the prescriptive requirements of Part 4.

8.4.1.2. Determination of Compliance

1) Subject to the limitations stated in Article 8.4.1.3., compliance with this Part shall be determined based on Sentences (2) to (5).

2) The *annual energy consumption* of the proposed *building*, as determined in accordance with this Part, shall not exceed the *building energy target* of the reference *building*.

3) The number of hours during which the heating loads for each *thermal block* are not met shall not exceed 100 hours in a simulated year for both the proposed and reference *buildings*.

4) The number of hours during which the cooling loads for each *thermal block* of the proposed *building* are not met shall not differ by more than $\pm 10\%$ from the number of hours in a simulated year that the cooling loads of the reference *building* are not met.

5) Where the requirements of Sentences (3) and (4) are not met, the capacities of the *primary* and *secondary systems* of the proposed or reference *building* shall be incrementally increased until those loads are met.

8.4.1.3. Limitations

1) Compliance with this Part shall be subject to the limitations stated in Sections 3.4., 4.4., 5.4., 6.4. and 7.4.

8.4.1.4. Treatment of Additions

(See Note A-8.4.1.4.)

1) For the purpose of performance compliance calculations, the assessment of *additions* shall be based on

- a) the *addition* being considered by itself, or
- b) the *addition* being considered together with the existing *building*.

2) Where the *addition* is being considered by itself, existing *primary* and *secondary systems* that are extended to serve the *addition* shall be modeled for the proposed *building*

- a) as if they met the prescriptive requirements of the Code, or
- b) using the characteristics of the existing equipment as determined in accordance with the standards referenced in Articles 5.2.12.1. and 6.2.2.1. (see Note A-8.4.1.4.(2)(b)).

3) When the *addition* is being considered together with the existing *building*, the characteristics of existing components shall be their actual characteristics determined in accordance with Sections 3.2., 4.2., 5.2., 6.2. and 7.2.

8.4.2. Compliance Calculations

8.4.2.1. General

1) Compliance with this Part shall be assessed through modeling that conforms to specifications detailed in this Part.

8.4.2.2. Calculation Methods

1) Except as provided in Sentence (5), the energy model calculations shall account for the *annual energy consumption* of

- a) space-heating equipment,
- b) space-cooling equipment,
- c) fans,
- d) *interior* and *exterior lighting* devices,
- e) *service water* heating equipment,
- f) pumps,
- g) auxiliary HVAC equipment (see Note A-8.4.2.2.(1)(g)),
- h) receptacle loads and miscellaneous equipment as per Article 8.4.2.7.,
- i) appliances, and
- j) elevators and escalators.

2) The energy model calculations shall be performed for a one-year period (8 760 hours) using time intervals no greater than one hour.

3) Operating schedules and climatic data input in the energy model shall use a time interval no greater than one hour.

4) If a computer program is used to carry out the compliance calculations, the calculation methods employed in the energy model shall conform to

- a) ANSI/ASHRAE 140, "Standard Method of Test for the Evaluation of Building Energy Analysis Computer Programs," or
- b) an equivalent test method.

5) Redundant or back-up equipment is permitted to be excluded from the energy model, provided it is equipped with controls that operate the equipment only when the primary equipment is not operating.

8.4.2.3. Climatic Data

(See Note A-8.4.2.3.)

1) The energy model calculations shall be performed using values of climatic data, including temperature, humidity and insolation, that are derived from measured climatic data and shown to be good representations of climate at the *building* site compared to the average of at least 10 years of measured data collected at the weather station nearest to the *building* site.

2) For urban regions with several climatic data sets and for locations where weather data are not available, the energy model calculations shall be performed using available weather data that best represents the climate at the *building* site.

8.4.2.4. Thermal Mass

1) The energy model calculations shall account for the effect of thermal mass.

8.4.2.5. Space Temperature

1) The energy model calculations shall include a dynamic calculation of space temperatures.

8.4.2.6.**8.4.2.6. Heat Transfer Between Thermal Blocks**

1) Where the temperature difference between two adjacent *thermal blocks* is greater than 10°C, the energy model calculations shall account for heat transfer between those *thermal blocks*.

2) Where the adjacent *thermal blocks* referred to in Sentence (1) are not fully separated by solid *partitions* or solid *building* elements, the energy model calculations shall use a heat transfer coefficient of 0.35 W/(m²×K).

8.4.2.7. Internal and Service Water Heating Loads

1) The energy model calculations shall account for the loads due to

- number of occupants,
- receptacle equipment,
- service water* heating systems, and
- miscellaneous equipment, as applicable.

(See Note A-8.4.2.7.(1).)

2) The energy model shall calculate the sensible and latent loads due to internal loads, lighting, and appliances. (See Notes A-8.4.3.2.(1) and A-8.4.3.2.(2).)

3) The internal loads shall be adjusted for each time interval referred to in Sentence 8.4.2.2.(3) based on the applicable operating schedule in Note A-8.4.3.2.(1).

4) The calculation of sensible loads due to lighting shall account for

- the lighting controls,
- the effect of the proportion of radiant and convective heat, and
- the percentage of heat gain from lighting going directly to return air.

5) Miscellaneous equipment located within a *conditioned space* that affects the energy consumption of one or more of the *building* systems described in Sentence 8.4.2.2.(1) shall be included in the energy model and its energy consumption shall be calculated.

8.4.2.8. Building Envelope

1) The energy model calculations shall account for heat transfer through walls, roofs and floors for each *thermal block*, while accounting for the dynamic response due to the thermal characteristics of the particular assembly.

2) Calculations of heat transfer through walls and roofs shall account for the effect of solar radiation absorbed on their exterior surfaces, which depends on the orientation and absorptance of each surface.

3) The energy model calculations shall account for heat transfer through *fenestration*, including *skylights*, while accounting for both indoor-outdoor temperature difference and transmission of solar radiation through the glazing.

4) Calculations of cooling and heating loads due to the transmission of solar radiation through *fenestration* shall account for

- the orientation of the *fenestration*,
- the solar optical properties of the glazing, and
- dynamic response due to the effect of the thermal characteristics of each *thermal block*.

5) The insulated surface areas of above-ground roof assemblies shall

- be calculated along the plane of the insulation using dimensions measured to the interior surfaces of intersecting exterior walls, and
- exclude openings for *skylights* and chimneys as measured to the surfaces of structural framing surrounding such openings.

6) The insulated surface areas of exterior above-ground wall assemblies shall

- be calculated using dimensions measured to the exterior surfaces of intersecting exterior walls and to the exterior ground level, exclusive of the perimeter areas where floor or roof slabs interrupt the wall construction,

- b) include perimeter areas of intersecting interior walls, and
- c) exclude openings for doors and *fenestration*, as measured to the surfaces of structural framing surrounding such openings.

7) The insulated surface areas of above-ground exterior floor assemblies shall be calculated using dimensions measured to the exterior surface of perimeter walls.

8) The insulated surface areas of roof assemblies in contact with the ground shall be calculated along the plane of the insulation using dimensions measured to the exterior surfaces of intersecting exterior walls.

9) The insulated surface areas of wall assemblies in contact with the ground shall be calculated using dimensions measured

- a) horizontally to the exterior surfaces of perimeter wall assemblies in contact with the ground, and
- b) vertically from the exterior ground level to the underside of intersecting floors in contact with the ground.

10) The insulated surface areas of floor assemblies in contact with the ground shall be calculated using dimensions measured to the exterior surfaces of perimeter walls.

8.4.2.9. Air Leakage

1) The energy model calculations shall account for air leakage through the *building envelope*.

2) The air leakage rate of the *building envelope* shall be adjusted using the following equation:

$$I_{AGW} = C \times I_{75Pa} \times \frac{S}{A_{AGW}}$$

where

I_{AGW} = adjusted air leakage rate of the *building envelope* at a typical operating pressure differential of 5 Pa and relative to the area of the above-ground walls, in L/(s×m²),

C = (5 Pa / 75 Pa)ⁿ, where n = flow exponent, which shall be 0.60, if no whole *building* test result is available, or the calculated value, if whole *building* testing is carried out in accordance with Article 3.2.4.2. and a series of tests are conducted at different differential pressures,

I_{75Pa} = assumed or measured normalized air leakage rate of the *building envelope* at a pressure differential of 75 Pa, in L/(s×m²),

where the measured air leakage rate at a pressure differential of 75 Pa is calculated as $I_{75Pa} = Q/S$,

where Q = volume of air flowing through the *building envelope* when subjected to a pressure differential of 75 Pa, determined in accordance with ASTM E779, "Standard Test Method for Determining Air Leakage Rate by Fan Pressurization," in L/s, and

S = total area of the *building envelope*, as per Sentence 3.2.4.2.(1), in m², and

A_{AGW} = total area of above-ground walls, in m².

(See Note A-8.4.2.9.(2).)

8.4.2.10. HVAC Systems Calculations

1) For the purpose of compliance calculations, the reference *building's* HVAC systems determined in accordance with Article 8.4.4.7. shall be modeled without substituting their components with thermodynamically similar components or using approximated calculations.

2) The energy model calculations shall account for the effect of terminal devices, *primary systems* and *secondary systems* having limited capacities on space temperature and energy use.

3) Where applicable, the energy modeling of *secondary systems* shall account for

- a) temperature rise of supply air due to heat from supply fan,

8.4.3.1.

- b) temperature rise of return air due to heat from return fan,
- c) temperature rise of return air due to heat gain from lights,
- d) fan power as a function of supply airflow,
- e) temperature and humidity rise or drop of supply or return air due to heat (sensible and latent energy) transferred from a heat-recovery device, and
- f) temperature rise of the outside air due to preheaters.

- 4)** The energy model calculations shall determine how many hours the *primary system*, *secondary system* and terminal device loads are not met.
- 5)** The energy model calculations shall account for the efficiency and capacity of the HVAC equipment as a function of part load and parameters such as, but not limited to, the temperatures of entering fluids and climatic conditions.

8.4.3. Annual Energy Consumption of Proposed Building**8.4.3.1. General**

- 1)** The *annual energy consumption* of the proposed *building* shall be calculated as described in this Subsection.
- 2)** Except as stated otherwise in this Subsection, the energy model shall be consistent with the proposed *building's* specifications including proper accounting of
 - a) *fenestration*, doors and *opaque building assembly* types and areas,
 - b) lighting systems and controls,
 - c) HVAC system types, capacities and controls,
 - d) *service water* heating system types, capacities and controls, and
 - e) electrical systems.
- 3)** The energy model calculations shall include all the energy use addressed in Sections 3.2., 4.2., 5.2., 6.2. and 7.2.
- 4)** Each conditioned *thermal block* in the proposed *building* shall be modeled as being
 - a) heated, if only heating systems are provided,
 - b) cooled, if only cooling systems are provided, and
 - c) heated and cooled, if complete heating and cooling systems or only rough-ins are provided.
- 5)** For the purpose of compliance calculations, where a *building* system or part of a *building* system has not been fully specified, it shall be assumed that it complies with the prescriptive requirements.
- 6)** Where a *building envelope* assembly covers less than 5% of the total area of that assembly type, it is permitted to be excluded from the energy model, provided its area is included in an adjacent assembly having a similar U-value and the same orientation.
- 7)** The energy model calculations shall not include manually operated *fenestration* shading devices, such as blinds or shades.
- 8)** The energy model calculations shall include permanent *fenestration* shading devices, such as fins, overhangs, and light shelves.

8.4.3.2. Operating Schedules, Internal Loads, Service Water Heating Loads and Set-point Temperature

- 1)** The operating schedules relating to the presence of occupants and of loads due to the operation of lighting, receptacle equipment, and heating, cooling and *service water* heating systems shall be representative of the proposed *building's* type or space functions. (See Note A-8.4.3.2.(1).)
- 2)** Internal loads, *service water* heating loads, and illuminance levels used in the energy compliance calculations shall be representative of the proposed *building's* type or space functions. (See Note A-8.4.3.2.(2).)
- 3)** For semi-heated *buildings*, as defined in Sentence 1.2.1.2.(2), the set-point temperature of the proposed *building* shall be that shown in the specifications.

8.4.3.3. Building Envelope Components

- 1) Where the solar absorptance of a *building envelope* component is not known, the energy model shall use a constant value of 0.7.
- 2) Where the energy model does not include a detailed calculation of *fenestration* shading, the actual solar heat gain coefficient of the *fenestration* shall be multiplied by an adjustment factor of 0.8. (See Note A-8.4.3.3.(2).)
- 3) Except as provided in Sentence (4), the normalized air leakage rate shall be assumed to be 1.50 L/(s×m²) at a pressure differential of 75 Pa and adjusted for the air leakage rate through the above-ground wall areas at the typical operating pressure differential in accordance with Sentence 8.4.2.9.(2).
- 4) Where an air leakage rate is determined in accordance with Article 3.2.4.2., the normalized air leakage rate at a pressure differential of 75 Pa and the flow exponent from the test are permitted to be used in Sentence 8.4.2.9.(2) to obtain the air leakage rate at a typical operating pressure differential and applied to the above-ground wall areas.

8.4.3.4. Interior Lighting

- 1) *Dwelling units* shall be modeled with an installed lighting power density of 5 W/m².
- 2) Where controls based on space occupancy are provided, the *installed interior lighting power* shall be multiplied by the factor for occupancy control, $F_{occ,iv}$ and the factor for personal control, $F_{pers,iv}$ as determined in accordance with Article 4.3.2.10. for the appropriate occupancy-sensing mechanism.
- 3) Where daylight-dependent controls are provided, daylighting calculations shall be performed
 - a) for the lighting fixtures controlled by the daylight-dependent controls, and
 - b) where the energy model is unable to perform detailed daylighting calculations, by multiplying the *installed interior lighting power* in the daylighted area by the factor for daylight harvesting, $F_{DL,iv}$ as calculated in accordance with Article 4.3.2.7.
- 4) The illumination set-point of the photocontrols referred to in Sentence (3) shall be representative of the space use without task lighting. (See Note A-8.4.3.4.(4).)

8.4.3.5. Purchased Energy

(See Note A-8.4.3.5.)

- 1) Where the proposed *building* uses purchased energy for space heating or cooling or *service water* heating, Sentences (2) to (5) shall apply.
- 2) Where purchased energy is used for heating, the equipment used to provide this energy shall be modeled as a gas-fired modulating *boiler* that
 - a) is sized for the peak heating load provided by the purchased energy system, and
 - b) complies with Section 5.2.
- 3) Where purchased energy is used for cooling, the equipment used to provide this energy shall be modeled as an electric air-cooled chiller that
 - a) is sized for the peak cooling load provided by the purchased energy system, and
 - b) complies with Table 8.4.3.5.

Table 8.4.3.5.
Type and Performance Levels of Chiller Providing Purchased Energy
 Forming Part of Sentences 8.4.3.5.(3) and 8.4.4.6.(2)

Cooling Capacity, kW (Btu/h)	Type	COP	IPLV
< 528 (1 800 000)	Scroll	2.802	3.664
≥ 528 (1 800 000)	Screw	2.802	3.737

8.4.3.6.

- 4)** Where purchased energy is used for *service water* heating, the equipment used to provide this energy shall be modeled as a gas-fired *service water* heater that
- is sized for the peak heating capacity provided by the purchased energy system,
 - complies with Section 6.2., and
 - where the purchased energy is used to heat *service water* in a heater with a storage tank, has the same storage capacity.
- 5)** The operating schedule, priority of use and other operational characteristics of the purchased energy shall be included in the energy model.

8.4.3.6. Outdoor Air

1) For the purpose of compliance calculations, the peak outdoor air ventilation rates shall be set to the minimum rates required by the applicable ventilation standard, based on the proposed *building's* specifications. (See Note A-8.4.3.6.(1).) (See also Note A-5.2.3.4.(1).)

8.4.3.7. Space Temperature Control

1) Where the proposed *building's* specifications do not specify the throttling ranges of the heating and cooling equipment, the energy model shall use a range of $\pm 1^{\circ}\text{C}$.

8.4.3.8. Part-Load Performance Curves

1) Part-load performance curves for the proposed *building's* systems shall be consistent with the equipment detailed in the *building* specifications.

2) Where part-load performance curves referred to in Sentence (1) are not available, the performance curves provided in Subsection 8.4.5. shall be used.

8.4.3.9. Ice Plants

(See Note A-8.4.3.9.)

1) Where the proposed *building* contains an ice plant that recovers heat but the energy modeling software does not allow for modeling of the ice plant and/or of heat recovery from this ice plant, the plant shall be modeled as a water-cooled, double-bundle water chiller.

8.4.4. Building Energy Target of the Reference Building**8.4.4.1. General**

1) The *building energy target* of the reference *building* shall be calculated based on the parameters described in this Subsection.

2) The components and systems of the reference *building* shall meet the prescriptive requirements of Sections 3.2., 4.2., 5.2., 6.2. and 7.2.

3) The energy model calculations shall include all the energy uses addressed in Sections 3.2., 4.2., 5.2., 6.2. and 7.2.

4) Except as noted otherwise in this Subsection, the following characteristics of the reference *building* shall be modeled as being identical to those of the proposed *building*:

- total floor area of *conditioned* and *unconditioned* spaces,
- use of *building* spaces,
- number, type and conditioning of *thermal blocks*,
- shape and exterior dimensions, and
- orientation.

5) The presence or absence of heating and/or cooling systems in each *conditioned thermal block* of the reference *building* shall be modeled as being identical to those in the proposed *building*.

6) Climatic data used in the compliance calculations for the proposed *building* shall be applied.

7) The simulation shall account for the effect of part-load operation on equipment performance.

8.4.4.2. Operating Schedules, Internal Loads, Service Water Heating Loads and Set-point Temperature

1) Except as provided in Sentence (3), and except as needed to model the occupancy controls required in the prescriptive path, the reference *building's* operating schedules shall be modeled as being identical to those determined for the proposed *building* in Sentence 8.4.3.2.(1). (See Note A-8.4.4.2.(1).)

2) The reference *building's* internal and *service water* heating loads shall be modeled as being identical to those determined for the proposed *building* in Sentence 8.4.3.2.(2).

3) If the reference *building* is a semi-heated *building*, as defined in Sentence 1.2.1.2.(2), and the capacity of the installed heating equipment in the semi-heated proposed *building* is no more than the semi-heated proposed *building's* peak heating load plus 5%, it shall be modeled with

- a) a set-point temperature of 18°C, and
- b) thermal characteristics that are based on the heating degree-days at 18°C of the *building's* location.

(See Note A-8.4.4.2.(3).)

8.4.4.3. Building Envelope Components

1) Except as provided in Sentence (2), the solar absorptance of each *opaque building assembly* shall be modeled as being identical to that determined for the proposed *building* in Sentence 8.4.3.3.(1).

- 2) The solar absorptance of roof assemblies shall be
- a) if the actual solar absorptance for the proposed *building* is not used, set to the same value used in the proposed *building*, or
 - b) if the actual solar absorptance for the proposed *building* is used, set to 0.7.

3) If the total vertical *fenestration* and door area to gross wall area ratio (FDWR) of the proposed *building* differs from the maximum permitted by Article 3.2.1.4., the FDWR of the reference *building* shall be adjusted proportionally along each orientation until it complies with that Article.

4) Permanent *fenestration* shading devices and projections shall not be modeled in the reference *building*.

5) If the proposed *building* is modeled with exterior shading provided by a nearby structure or *building*, the reference *building* shall also be modeled as such.

6) The air leakage rate shall be equal to the default value determined in Sentence 8.4.3.3.(3).

7) Heat transfer through interior *partitions* shall be modeled as being identical to that of the proposed *building*.

8) Except for *overall thermal transmittance*, *fenestration* shall be modeled with thermal and optical properties that are identical to those used for the proposed *building*. (See Note A-8.4.4.3.(8).)

8.4.4.4. Thermal Mass

1) The thermal characteristics of the reference *building's building envelope* assembly shall be modeled as being identical to those of lightweight construction. (See Note A-8.4.4.4.(1).)

2) The thermal characteristics of the reference *building's* space shall be modeled as being identical to those of the proposed *building*. (See Note A-8.4.4.4.(2).)

8.4.4.5. Lighting

1) Except as provided in Sentences (2) and (3), the *installed interior lighting power* of the reference *building* shall be set at the *interior lighting power allowance* determined in Article 4.2.1.5. or 4.2.1.6., as applicable.

- 2)** *Dwelling units* shall be modeled with an installed lighting power density of 5 W/m².
- 3)** Where controls based on space occupancy are required by Subsection 4.2.2., the *installed interior lighting power* shall be multiplied by the factor for occupancy control, $F_{occ,iv}$ and the factor for personal control, $F_{pers,iv}$ as determined in accordance with Article 4.3.2.10. for the appropriate occupancy-sensing mechanism. (See Note A-8.4.4.5.(3).)
- 4)** The proportions of radiant and convective heat and the percentage of heat gain from lighting going directly to return air shall be modeled as being identical to those determined for the proposed *building* in Article 8.4.2.7.
- 5)** Except as provided in Sentence (9), for the purpose of determining the primary and secondary sidelighted areas, the total *fenestration* area of each *thermal block* shall be modeled for each orientation as a single centered window with the following characteristics:
- a sill located 0.9 m above the floor,
 - a window opening height of 1.8 m, and
 - a width that would result in a window-to-wall ratio meeting the maximum FDWR value permitted by Article 3.2.1.4.
- 6)** The primary and secondary sidelighted areas shall be determined assuming a depth of 2 m. (See Note A-8.4.4.5.(6).)
- 7)** For the purpose of determining the daylighted area under *skylights*, the calculations shall be performed assuming a single square *skylight* positioned at the centre of each *thermal block*
- that is sized to meet the maximum *skylight*-to-roof ratio permitted by Article 3.2.1.4., and
 - whose projection onto the floor extends horizontally in all directions for a distance equal to 0.5 times the *ceiling height*.
- (See Note A-8.4.4.5.(7).)
- 8)** The combined input power within the daylighted areas shall be the sum of the daylighted areas multiplied by the appropriate *interior lighting power allowance* specified in Table 4.2.1.6.
- 9)** Where photocontrols are required by Subsection 4.2.2., their effect shall be evaluated in accordance with Sentences (10) to (12).
- 10)** Calculations of daylighting levels in each *thermal block* shall be performed assuming
- the *thermal block* is a single open space surrounded by opaque walls,
 - floor, wall and ceiling reflectances of 0.15, 0.50 and 0.80, respectively (see Note A-8.4.4.5.(10)(b)),
 - illuminance levels measured at a height of 0.75 m from the floor, at the edge of the daylighted areas that is the farthest from the source of daylight and measured perpendicular to this source, and
 - a *fenestration* visible light transmittance corresponding
 - to the area-weighted average of the visible light transmittance for that *thermal block* in the proposed *building*,
 - or
 - if there is no *fenestration* in the proposed *building's* corresponding *thermal block*, to a value of 0.50.
- 11)** The illumination set-point of the photocontrols shall
- be identical to that of the proposed *building's* photocontrols, or
 - if there are no photocontrols in the proposed *building*, be representative of the space use without task lighting.
- (See Note A-8.4.4.5.(11).)
- 12)** Where the energy model is unable to perform detailed daylighting calculations, the *interior lighting power allowance* in the daylighted area shall be multiplied by the factor for daylight harvesting, $F_{DL,iv}$ as calculated in accordance with Article 4.3.3.7.

8.4.4.6. Purchased Energy

- 1)** Where a primary heating system of the proposed *building* uses purchased energy, the reference *building's* corresponding system shall be modeled in accordance with the requirements of Article 8.4.4.9. adjusted as follows:
 - a) one gas-fired modulating *boiler* complying with Section 5.2. shall be used to represent the purchased energy equipment, and
 - b) the total capacity of the *boiler*, relative to the reference *building's* total heating capacity, shall correspond to the ratio of the proposed *building's* purchased energy capacity divided by its total heating capacity.

- 2)** Where a primary cooling system of the proposed *building* uses purchased energy, the reference *building's* corresponding system shall be modeled in accordance with the requirements of Article 8.4.4.10. adjusted as follows:
 - a) one air-cooled electric chiller complying with Table 8.4.3.5. shall be used to represent the purchased energy equipment, and
 - b) the total capacity of the chiller, relative to the reference *building's* total cooling capacity, shall correspond to the ratio of the proposed *building's* purchased energy capacity divided by its total cooling capacity.

- 3)** Where a primary *service water* heating system of the proposed *building* uses purchased energy, the reference *building's* corresponding system shall be modeled in accordance with the requirements of Article 8.4.4.20. adjusted as follows:
 - a) one gas-fired *service water* heater shall be used to represent the purchased energy equipment,
 - b) where the proposed *building's* purchased energy system is used to heat *service water* in a heater with a storage tank, the *service water* heater shall have the same storage capacity, and
 - c) the total heating capacity of the *service water* heaters, relative to the reference *building's* total *service water* heating capacity, shall correspond to the ratio of the proposed *building's* purchased energy capacity divided by its total heating capacity.

- 4)** The operating schedule, priority of use and other operational characteristics of the proposed *building's* use of purchased energy shall apply to the equipment representing the purchased energy in Sentences (1) to (3).

8.4.4.7. HVAC System Selection

- 1)** Except as provided in Sentences (2) and (4), the type of HVAC system assigned to each *thermal block* of the reference *building* shall be determined based on each *thermal block's building* or space type using Table 8.4.4.7.-A with the corresponding descriptions in Table 8.4.4.7.-B.

- 2)** Where the area of a *building* or space type in the proposed *building* accounts for 10% or less of the total area of *conditioned spaces*, it is permitted to be excluded from the energy model, provided its area is added to an adjacent *building* or space type having similar space loads as those listed in Sentence 8.4.2.2.(1) and similar operating schedules as those determined in Sentence 8.4.3.2.(1).

**Table 8.4.4.7.-A
HVAC System Selection for the Reference Building**
Forming Part of Sentences 8.4.4.7.(1) and (3), 8.4.4.9.(1) and (3), 8.4.4.10.(1) and (7), 8.4.4.13.(1), 8.4.4.14.(6) and 8.4.4.18.(6)

<i>Building</i> or Space Type of the Proposed <i>Building</i>	Size of <i>Building</i> or Space ⁽¹⁾⁽²⁾	Type of HVAC System Required ⁽³⁾
Assembly Area: exhibit space, conference/meeting/multi-purpose room, performing arts/motion picture <i>theatre</i> , courtroom, classroom/lecture/training room, place of worship, fellowship hall, sports centre, arena and swimming pool seating area, waiting room	Maximum 4 <i>storeys</i>	System 3
	More than 4 <i>storeys</i>	System 6
Automotive Area: <i>repair garage</i> or <i>storage garage</i> , fire engine room, indoor truck dock, indoor bus or train platform	All sizes	System 4

Table 8.4.4.7-A (Continued)

<i>Building or Space Type of the Proposed Building</i>	<i>Size of Building or Space⁽¹⁾⁽²⁾</i>	<i>Type of HVAC System Required⁽³⁾</i>
Data Processing Area: control room, data centre	All sizes	Where the proposed <i>building</i> or space has a cooling capacity exceeding 20 kW, the reference <i>building</i> or space shall use System 2; otherwise, the reference <i>building</i> or space shall use System 1.
General Area: office, banking, healthcare clinic, library, retail/mall concourse, gymnasium, athletic play area, swimming pool, exercise centre, dressing room, lighting control room, atrium	Maximum 2 storeys	System 3
	More than 2 storeys	System 6
Historical Collections Area: archival library, museum and gallery archives	All sizes	System 2
Hospital Area: operating theatre, emergency room, patient/recovery room, clean room, hospital laboratories, forensics laboratory	All sizes	System 3
Indoor Arena: ice rinks, curling rinks	All sizes	System 2
Industrial Area: industrial manufacturing and workshop without dust-exhausting hood	All sizes	System 3 Where the reference <i>building</i> or space is a single zone, it can be divided into multiple units as long as it matches the proposed <i>building</i> or space's units.
Residential/Accommodation Area: multi-unit residential, hotel/motel guest room	All sizes	Where the proposed <i>building</i> or space is heated only, the reference <i>building</i> or space shall use System 1.
		Where the proposed <i>building</i> or space is heated as well as being cooled with an air-cooled unitary, packaged terminal or room air conditioner (or heat pumps), or fan coils, the reference <i>building</i> or space's HVAC system shall be modeled as being identical to that of the proposed <i>building</i> or space; otherwise, the reference <i>building</i> or space shall use through-the-wall systems.
Sleeping Area: dormitory, detention cell, sleeping quarters	All sizes	System 3
Supermarket/Food Service Area: grocery store, bar lounge/leisure, cafeteria, fast food, family dining, food preparation without kitchen hood or vented appliance ⁽⁴⁾ food preparation with kitchen hood or vented appliance ⁽⁴⁾	All sizes	System 3
	All sizes	System 4
Warehouse Area: fine, medium and bulky material storage, self-storage, material handling/sorting/baggage areas	All sizes of non-refrigerated space	System 4
	All sizes of refrigerated space	System 5

Notes to Table 8.4.4.7-A:

- (1) Spaces generally located in the same vicinity shall be grouped together for the purpose of selecting the reference *building's* type of HVAC system.
- (2) Small individual spaces in the proposed *building* that are located among larger spaces of another space type shall be considered ancillary to that larger space: for example, a conference room serving office spaces would be grouped with the office spaces as one space type. The HVAC system serving that space in the reference *building* shall be the same as the one for the larger space type.
- (3) See Table 8.4.4.7-B for descriptions of HVAC Systems 1 to 6.
- (4) Vented appliances include, for example, steam dishwashers.

Table 8.4.4.7.-B
Descriptions of HVAC Systems 1 to 6
 Forming Part of Sentences 8.4.4.7.(1), 8.4.4.9.(3) and 8.4.4.18.(3) and (4)

System Number	Type of HVAC System	Fan Control	Type of Cooling System	Type of Heating System ⁽¹⁾
System 1	Unitary air conditioner with baseboard heating ⁽²⁾	Constant-volume	Air-cooled direct-expansion with remote condenser	Hot water with fuel-fired water <i>boiler</i> or electric resistance baseboard
System 2	Four-pipe fan-coil ⁽²⁾	Constant-volume	Water-cooled water chiller	Fuel-fired or electric resistance water <i>boiler</i>
System 3	Single-zone packaged rooftop unit with baseboard heating	Constant-volume	Air-cooled direct-expansion	Fuel-fired or electric resistance <i>furnace</i> for rooftop, hot water with fuel-fired <i>boiler</i> , or electric resistance for baseboards
System 4	Single-zone make-up air unit with baseboard heating	Constant-volume	Air-cooled direct-expansion	Make-up air unit: electric or indirect fuel-fired <i>furnace</i>
				Baseboards: electric resistance or hydronic with fuel-fired <i>boiler</i>
System 5	Two-pipe fan-coil ⁽²⁾	Constant-volume	Water-cooled water chiller	None
System 6 ⁽³⁾	Multi-zone built-up system with baseboard heating	Variable-volume	Water-cooled water chiller	Baseboards: electric resistance or hydronic with fuel-fired <i>boiler</i>

Notes to Table 8.4.4.7.-B:

- (1) Where present, humidification systems in the reference *building* shall use the same energy source as the corresponding humidification system in the proposed *building*.
- (2) Except for HVAC systems serving *dwelling units*, outside air requirements for the *thermal blocks* served by those systems shall be met by a single ventilation system able to meet all the required outside and exhaust air rates. For HVAC systems serving *dwelling units*, outside air requirements shall be met by a ventilation system identical to that of the proposed *building*.
- (3) Where the *building* has no more than 4 above-ground *storeys*, the energy model shall include a single system serving the *thermal blocks* of all *storeys*. Where the *building* has more than 4 above-ground *storeys*, external *thermal blocks* shall be grouped together based on facade orientation and internal *thermal blocks* shall be grouped together, with each grouping served by a single system. A single independent system shall serve all underground *thermal blocks*.

3) If the *building* or space type of a *thermal block* of the proposed *building* is not listed in Table 8.4.4.7.-A, the type that most closely corresponds to that *thermal block* shall be used for the reference *building*.

4) For each *thermal block* of the proposed *building* having an HVAC system that includes a heat pump, the corresponding *thermal blocks* of the reference *building* shall be modeled with a type of HVAC system determined in accordance with Article 8.4.4.13.

8.4.4.8. Equipment Oversizing

(See Note A-8.4.4.8.)

1) The heating equipment of the reference *building* shall be modeled as being oversized by the lesser of

- a) the percentage of oversizing applied to the proposed *building*, or
- b) 30%.

2) The cooling equipment of the reference *building* shall be modeled as being oversized by the lesser of

- a) the percentage of oversizing applied to the proposed *building*, or
- b) 10%.

8.4.4.9. Heating System

1) Except as provided in Sentence (2), the heating system serving each *thermal block* of the reference *building* shall be determined in accordance with Table 8.4.4.7.-A and this Article.

2) Where the proposed *building* uses purchased energy, Article 8.4.4.6. shall apply to the reference *building*.

3) Where Tables 8.4.4.7.-A and 8.4.4.7.-B indicate that a heating system is required in the *secondary system* as well as in a terminal device, the heating capacity of each type of equipment shall be set as follows:

- a) the heating capacity of the terminal device shall meet the *thermal block's* heating load due to the transfer of energy through the *building envelope* only,
- b) the combined heating capacities of the heating systems in the terminal device and *secondary system* shall meet the peak heating load of the *thermal blocks* served by those systems, and
- c) the applicable oversize factor shall apply to each type of equipment.

4) Except as provided in Sentence (5), the energy type of the reference *building's* heating system shall be modeled as being identical to the energy type of the proposed *building's* heating system.

5) Where more than one energy type is used by the proposed *building's* heating system,

- a) the heating capacities of the reference *building's* heating equipment shall match the ratio of the proposed *building's* heating equipment capacity allocation, and
- b) the operating schedule, priority of use and other operational characteristics of the proposed *building's* use of energy types shall apply.

6) Where a hydronic system is modeled in the reference *building*, the heating plant shall be modeled as follows:

- a) the heating capacity of the heating plant shall be the sum of the heating capacities of the systems served by the plant, multiplied by the applicable oversize factor,
- b) where the heating capacity is not greater than 176 kW, the heating plant shall be modeled with one single-stage *boiler*,
- c) where the heating capacity is greater than 176 kW and not greater than 352 kW, the heating plant shall be modeled to operate as required by the reference *building's* load with
 - i) two *boilers* of equal capacity, or
 - ii) a two-staged *boiler* that operates in stages with a 1:2 ratio,
- d) where the heating capacity exceeds 352 kW, the heating plant shall be modeled with a *boiler* that is fully modulating down to 25% of its capacity,
- e) the pumping system shall be modeled as a *primary system* with constant speed operation,
- f) the peak pumping flow rate shall be set considering
 - i) the installed heating plant's capacity,
 - ii) use of pure water, and
 - iii) a 16°C temperature drop,
- g) the pump's operating schedule shall be modeled as being identical to that of the proposed *building*, and
- h) the hot water supply temperature shall be reset to
 - i) 82°C for an outside air temperature of -16°C, and
 - ii) 60°C for an outside air temperature of 0°C.

7) Where the reference *building* contains a *furnace*, it shall be modeled as follows:

- a) the heating capacity of the *furnace* shall be the sum of the heating loads of the *thermal blocks* served by the *furnace*, multiplied by the applicable oversize factor,
- b) where the heating capacity is not greater than 66 kW, the *furnace* shall be modeled with two stages of equal capacity, and
- c) where the heating capacity is greater than 66 kW, the *furnace* shall be modeled with a number of stages equal to its capacity divided by 66 kW and rounded up to the nearest integer.

8) Heating equipment performance characteristics as a function of part-load shall be modeled in accordance with the part-load performance curves found in Subsection 8.4.5.

8.4.4.10. Cooling Systems

- 1)** Except as provided in Sentence (2), the cooling system serving each *thermal block* of the reference *building* shall be determined in accordance with Table 8.4.4.7.-A and this Article.
- 2)** Where the proposed *building* uses purchased energy, Article 8.4.4.6. shall apply to the reference *building*.
- 3)** Except as provided in Sentence (4), the energy type of the reference *building's* cooling system shall be modeled as being identical to that of the proposed *building's* cooling system.
- 4)** Where more than one energy type is used by the proposed *building's* cooling system,
 - a) the cooling capacities of the reference *building's* cooling equipment shall match the ratio of the proposed *building's* cooling equipment capacity allocation, and
 - b) the operating schedule, priority of use and other operational characteristics of the proposed *building's* use of energy types shall apply.
- 5)** Cooling equipment performance characteristics as a function of part-load shall be modeled in accordance with the part-load performance curves found in Subsection 8.4.5.
- 6)** Where a hydronic system is installed, the cooling plant shall be modeled as follows:
 - a) the cooling capacity of the cooling plant shall be the sum of the cooling capacities of the systems served by the plant, multiplied by the applicable oversize factor,
 - b) where the cooling capacity is not greater than 2 100 kW, the cooling plant shall be modeled with one water chiller,
 - c) where the cooling capacity is greater than 2 100 kW, the cooling plant shall be modeled with two water chillers, each having half the capacity of the cooling plant's capacity,
 - d) the water chiller's pumping system shall be modeled as a *primary system* with constant speed operation,
 - e) the water chiller's pumping flow rate shall be set considering
 - i) the cooling plant's capacity,
 - ii) use of pure water, and
 - iii) a 6°C temperature rise,
 - f) the types of water chillers shall be modeled as being identical to those of the proposed *building*,
 - g) the chilled water supply temperature shall be set at 7°C, and
 - h) each water chiller shall be fully modulating down to 25% of its capacity.
- 7)** Where Table 8.4.4.7.-A indicates that a cooling system is required in the *secondary system* as well as in a terminal device, the cooling capacity of each type of equipment shall be set as follows:
 - a) the cooling capacity of the terminal device shall meet the *thermal block's* cooling load due to the transfer of energy through the *building envelope* and internal loads only,
 - b) the combined cooling capacities of the cooling systems in the terminal device and *secondary system* shall meet the peak cooling load of the *thermal blocks* served by the system, and
 - c) the applicable oversize factor shall apply on each type of equipment.
- 8)** Where a direct-expansion system is modeled in the reference *building*, that system shall be modeled as follows:
 - a) the cooling capacity of the system shall be the sum of the cooling loads of the *thermal blocks* served by the system, multiplied by the applicable oversize factor,

- b) where the cooling capacity of the system is not greater than 66 kW, the system shall be modeled with two stages of equal capacity, and
- c) where the cooling capacity is greater than 66 kW, the system shall be modeled with a number of stages equal to its capacity divided by 66 kW and rounded up to the nearest integer.

9) For water-cooled systems, heat rejection to the atmosphere shall be modeled in accordance with Article 8.4.4.11.

8.4.4.11. Cooling Tower Systems

1) Where applicable, water-cooled systems shall be paired to an axial-fan, direct-contact cooling tower that has

- a) a capacity equal to the nominal heat rejection rate of the equipment,
- b) inlet and outlet water temperatures of 35°C and 29°C, respectively, and
- c) an inlet outside air wet bulb temperature of 24°C.

2) A cooling tower with a capacity not greater than 1 750 kW shall be modeled with one cell.

3) A cooling tower with a capacity greater than 1 750 kW shall be modeled with a number of cells equal to its capacity divided by 1 750 and rounded up to the nearest integer.

4) The pumping system shall be modeled as constant speed operation.

5) The pumping flow rate shall be set considering

- a) the cooling tower's capacity,
- b) use of pure water, and
- c) a 6°C temperature drop.

6) The fan of each cooling tower cell shall be modeled with cycling control to maintain an outlet water temperature of 29°C.

7) Cooling tower equipment performance characteristics as a function of part-load shall be modeled in accordance with the part-load performance curves found in Subsection 8.4.5.

8.4.4.12. Cooling with Outside Air

1) Where Article 5.2.2.7. applies to a proposed *building's* HVAC system, the HVAC systems of the corresponding *thermal blocks* in the reference *building* shall be modeled in accordance with that Article and Table 8.4.4.12.

Table 8.4.4.12.
Applicable Requirements for Cooling with Outside Air According to Type of HVAC System
Forming Part of Sentence 8.4.4.12.(1)

Type of System	Applicable Article for Cooling with Outside Air
HVAC systems 1, 3, 4 and 6 ⁽¹⁾	5.2.2.8.
HVAC systems 2 and 5 ⁽¹⁾	5.2.2.9.
All types of heat pump systems ⁽²⁾	5.2.2.8.

Notes to Table 8.4.4.12.:

⁽¹⁾ See Table 8.4.4.7.-B.

⁽²⁾ See Table 8.4.4.13.

8.4.4.13. Heat Pumps

(See Note A-8.4.4.13.)

1) Except as provided in Sentence (2), where the proposed *building's* HVAC system includes a water loop heat pump that supplies conditioned air to a *thermal block* or conditioned water to a hydronic loop, the reference *building's* HVAC system for that *thermal block* shall be selected using Table 8.4.4.7.-A. (See Note A-8.4.4.13.(1).)

- 2)** Where the proposed *building's* HVAC system includes an air-source, water-source or ground-source heat pump that supplies conditioned air to a *thermal block* or conditioned water to a hydronic loop,
- a) the reference *building's* HVAC system for that *thermal block* or for the *thermal blocks* supplied by the hydronic loop shall be an air-source heat pump described in Table 8.4.4.13.,
 - b) the heat pump's cooling capacity shall be set based on the peak cooling load, without oversizing,
 - c) the heat pump's heating capacity at an outdoor air temperature of 8.3°C shall be identical to its cooling capacity and reduced to 50% at -8.3°C,
 - d) the heat pump shall not operate in heating mode when the outdoor air temperature is below -10°C,
 - e) the heat pump's part-load performance shall be modeled in accordance with Subsection 8.4.5.,
 - f) the terminal heating's capacity or the heat pump's auxiliary heating capacity shall be set based on the peak heating load of the *thermal block* and the requirements of Subsections 8.4.1., 8.4.2. and 8.4.4.,
 - g) except as provided in Clause (h), the energy type of the heat pump's terminal heating or auxiliary heating shall be
 - i) for an air-source heat pump, the energy type used for terminal or auxiliary heating of the *thermal blocks* of the proposed *building* served by that heat pump and having the largest annual energy use, provided the heat pump exceeds 33% of the total annual energy use for space heating for these *thermal blocks*, or
 - ii) for a water-source or ground-source heat pump, the energy type used for terminal or auxiliary heating of the *thermal blocks* of the proposed *building* served by all the heat pumps connected to the same water loop and having the largest annual energy use, provided the heat pump exceeds 33% of the total annual energy use for space heating for these *thermal blocks*, and
 - h) where the heat pump is not an air-, water- or ground-source pump, the energy type of the heat pump's terminal heating or auxiliary heating shall be electricity.

Table 8.4.4.13.
Heat Pump System Description
 Forming Part of Sentences 8.4.4.13.(2), 8.4.4.14.(6) and 8.4.4.18.(6)

System Number ⁽¹⁾	Type of System	Fan Control	Type of Terminal or Auxiliary Heating
Systems 1 and 3 to 6	Packaged unitary rooftop heat pump	Constant volume	Rooftop unit: fuel-fired or electric resistance <i>furnace</i>
			Baseboards: electric resistance or hydronic with fuel-fired <i>boiler</i>
System 2	See Table 8.4.4.7.-B		

Notes to Table 8.4.4.13.:

⁽¹⁾ System number is based on building or space type determined in accordance with Table 8.4.4.7.-A.

8.4.4.14. Hydronic Pumps

1) Except as provided in Sentences (2) and (3), each hydronic pump of the reference *building* shall have a total static head and efficiency identical to that of the corresponding pump of the proposed *building*.

2) Where the proposed *building* uses more than one pump in a given hydronic system, the peak shaft power demand of the reference *building's* pump shall be modeled as being identical to the combined peak shaft power demand of the proposed *building's* pumps. (See Note A-8.4.4.14.(2).)

3) Where the total static head or efficiency of the proposed *building's* hydronic pump is not known, the characteristics of the reference *building's* hydronic pump shall be based on the peak power demand, in W/(L/s), of the proposed *building's* pump.

4) Pump power, P , versus flow rate, V , shall be calculated using one of the following equations:

$$\text{If } V_{\text{partload}}/V_{\text{rated}} < D, \text{ then } P_{\text{partload}} = P_{\text{rated}} \times E$$

$$\text{If } V_{\text{partload}}/V_{\text{rated}} \geq D, \text{ then } P_{\text{partload}} = P_{\text{rated}} \times \left[A + B \times (V_{\text{partload}}/V_{\text{rated}}) + C \times (V_{\text{partload}}/V_{\text{rated}})^2 \right]$$

where

V_{partload} = flow rate at part-load conditions, in L/s,

V_{rated} = flow rate at rated conditions, in L/s,

P_{partload} = power draw at part-load conditions, in kW,

P_{rated} = power draw at rated conditions, in kW, and

A, B, C, D, E = coefficients defined in Table 8.4.4.14.

Table 8.4.4.14.
Coefficients Used in Calculating Pump Power versus Flow Rate
Forming Part of Sentence 8.4.4.14.(4)

Coefficients	Type of Pump	
	Pump Riding its Curve	Pump with Variable Speed Drive
A	0.227143	0.00153028
B	1.178929	0.00520806
C	-0.41071	1.0086242
D	0.47	0.20
E	0.68	0.04

5) Variable-flow pumps shall be modeled as a pump riding its curve.

6) Where the *secondary system* defined in Tables 8.4.4.7.-A and 8.4.4.13. represents equipment meeting the requirements of Article 5.2.12.1. and whose minimum performance includes pump energy (in part or in whole), the performance of the heating and cooling equipment of the *secondary system* shall be adjusted so that the maximum power demand of the system, including pump power demand, meets the requirements of Article 5.2.12.1.

8.4.4.15. Outdoor Air

1) The peak outdoor air ventilation rates for the reference *building* shall be identical to those determined for the proposed *building* in Sentence 8.4.3.6.(1).

2) Where demand control ventilation strategies required by Article 5.2.3.4. are implemented in the proposed *building*, the reference *building* shall be modeled with those same strategies.

8.4.4.16. Space Temperature Control

1) If an in-floor, in-ceiling or in-wall radiant heating and/or cooling system is used in the proposed *building* but the energy model calculations do not allow for modeling of radiant effects, each conditioned *thermal block* in the reference *building* shall be modeled using heating and/or cooling temperature schedules, as applicable, that are 2°C warmer and 2°C cooler respectively than those used for the proposed *building* in Sentence 8.4.3.2.(1).

2) The throttling range of the heating and cooling equipment shall be modeled as being identical to that determined for the proposed *building* in Sentence 8.4.3.7.(1).

8.4.4.17. Fans

1) Where the HVAC system of a *thermal block* of the proposed *building* includes a fan that exhausts air directly to the outside and complies with Sentences 5.2.3.1.(2) and 5.2.10.1.(3), its flow rate, power demand, operating schedule and part-load performance shall be modeled identically in the reference *building*. (See Note A-8.4.4.17.(1).)

2) Fan power, P, versus flow rate, F, shall be calculated using one of the following equations:

If $F_{partload}/F_{rated} < D$, then $P_{partload} = P_{rated} \times E$

If $F_{partload}/F_{rated} \geq D$, then $P_{partload} = P_{rated} \times [A + B \times (F_{partload}/F_{rated}) + C \times (F_{partload}/F_{rated})^2]$

where

- $F_{partload}$ = flow rate at part-load conditions, in L/s,
 - F_{rated} = flow rate at rated conditions, in L/s,
 - $P_{partload}$ = power draw at part-load conditions, in kW,
 - P_{rated} = power draw at rated conditions, in kW, and
 - A, B, C, D, E = coefficients defined in Table 8.4.4.17.
- (See Note A-8.4.4.17.(2).)

Table 8.4.4.17.
Coefficients Used in Calculating Fan Power versus Flow Rate
 Forming Part of Sentence 8.4.4.17.(2)

Type of Fan	Coefficients				
	A	B	C	D	E
Airfoil or backward inclined riding fan curve	0.227143	1.178929	-0.41071	0.47	0.68
Airfoil or backward inclined with inlet vanes	0.584345	-0.57917	0.970238	0.35	0.50
Forward curved with inlet vanes	0.339619	-0.84814	1.495671	0.25	0.22
Variable speed drive	0.00153028	0.00520806	1.0086242	0.20	0.04

3) Except as provided in Sentences (4) and (5), individual fans shall be modeled as airfoil or backward inclined riding fan curve.

4) Where variable-air-volume fans are used, individual fans having a fan power greater than 7.5 kW and less than 25 kW shall be modeled as airfoil or backward inclined with inlet vanes.

5) Where variable-air-volume fans are used, individual fans having a fan power greater than or equal to 25 kW shall be modeled as forward curved with inlet vanes.

8.4.4.18. Supply Air Systems

1) The supply airflow rate provided by *secondary systems* shall be modeled as being equal to the sum of the airflow rates supplied to each of the *thermal blocks* calculated in accordance with Sentence (2).

- 2)** The supply airflow rate to a *thermal block* shall be modeled as being the greater of
 - a) the airflow rate for heating, based on the peak heating load and a temperature difference of 21°C,
 - b) the airflow rate for cooling, based on the peak cooling load and a temperature difference of 11°C, or
 - c) the outdoor air ventilation rate supplied to the *thermal block* in the proposed *building*.

3) Except as provided in Sentence (6), HVAC systems 1 to 5 of Table 8.4.4.7.-B shall be modeled with

- a) a supply air temperature that is reset according to the *thermal block's* load,

- b) a supply fan that has a static pressure of 640 Pa and a combined fan-motor efficiency of 40%, and
- c) no return fan.

4) Except as provided in Sentence (6), HVAC system 6 of Table 8.4.4.7.-B shall be modeled with

- a) a default supply air temperature of 13°C, with the supply air temperature reset in accordance with Article 5.2.8.9.,
- b) a supply fan that has a static pressure of 1 000 Pa and a combined fan-motor efficiency of 55%, and
- c) a return fan that has a static pressure of 250 Pa and a combined fan-motor efficiency of 30%.

5) Where the proposed *building's secondary system* does not meet the requirements of Clause 5.2.3.1.(1)(b), the reference *building's secondary system* shall be modeled as having an identical fan power demand.

6) Where a *secondary system* defined in Tables 8.4.4.7.-A and 8.4.4.13. comprises equipment whose fan energy is included in the minimum performance level required by Tables 5.2.12.1.-A to 5.2.12.1.-P, the capacity and performance of its heating and cooling equipment shall be adjusted so the maximum power demand of the *secondary system*, including fan power demand, meets the requirements of Article 5.2.12.1.

8.4.4.19. Energy Recovery Systems

1) Where Subsection 5.2.10. applies to a reference *building's* HVAC system, that system shall be modeled with energy recovery capabilities that comply with Subsection 5.2.10. and Sentences (2) and (3).

2) Energy recovered from an HVAC system's exhaust air shall be used to preheat the outside air supplied by that system.

3) Where the proposed *building* has ice-making loads along with simultaneous heating and/or *service water* heating loads, the reference *building's* ice plant shall be modeled with the following characteristics and components:

- a) a water-cooled, double-bundle water chiller having 100% heat-recovery capacity, where the energy model calculations do not allow for modeling of the ice plant and/or of heat recovery from the ice plant,
- b) operation and performance characteristics, such as efficiency, capacity, part-load performance and pumping flow rates, that are identical to those of the proposed *building's* machine,
- c) peak load and demand schedules that are identical to those of the proposed *building*, and
- d) heat rejection to
 - i) at least one hydronic system for heating or *service water* heating, where the system has a load, and
 - ii) the atmosphere using a cooling tower defined in accordance with Articles 8.4.4.10. and 8.4.4.11., when the heat rejected is greater than the coincident heating load (see Note A-8.4.3.9.).

8.4.4.20. Service Water Heating Systems

1) Except as provided in Sentences (2) to (4), the reference *building's service water* heating system shall be modeled as being identical to that of the proposed *building* as regards the following characteristics:

- a) storage capacity,
- b) power input, and
- c) energy type.

2) Where the energy type of the proposed *building's service water* heating system is an air-, water- or ground-source heat pump, the energy type of the reference *building's service water* heating system shall be an air-source heat pump.

3) Where the energy type of the proposed *building's service water* heating system is an immersion coil supplied by a *boiler*, the energy type of the reference *building's service water* heating system shall be the same as that of the *boiler*.

4) Where more than one energy type is used by the proposed *building's service water* heating system,

- a) the heating capacities of the reference *building's service water* heating equipment shall match the ratio of the proposed *building's service water* heating equipment capacity allocation (see Note A-8.4.4.20.(4)(a)), and
- b) the operating schedule, priority of use and other operational characteristics of the proposed *building's* use of energy types shall apply.

5) *Service water* heating equipment performance characteristics as a function of part-load shall be modeled in accordance with the part-load performance curves found in Subsection 8.4.5.

6) The *service water* heating system's supply temperature shall be modeled as being identical to that of the proposed *building*. (See Note A-8.4.4.20.(6).)

7) Where a storage tank is to be modeled, the *service water* heating system's storage temperature shall be modeled as being identical to that of the proposed *building*. (See Note A-8.4.4.20.(7).)

8) Where the proposed *building's service water* heating system comprises multiple water heaters, the reference *building's service water* heating system shall be modeled with the same number of water heaters.

9) Where the proposed *building's service water* heating system is a recirculation system, the circulation pumps shall be modeled as a single pump with

- a) constant speed operation, and
- b) a total flow rate and pumping power, in W/(L/s), that are identical to that of the proposed *building's* circulation pumps.

8.4.5. Part-Load Performance Characteristics

8.4.5.1. General

1) Part-load performance curves for the reference *building's* systems shall be calculated in accordance with Articles 8.4.5.2. to 8.4.5.9., using the parameters described in this Subsection.

8.4.5.2. Boiler

1) The fuel consumption at part-load conditions, $Fuel_{partload}$, in Btu/h, of the reference condensing or non-condensing *boiler* shall be derived by applying an adjustment factor to the fuel consumption at design conditions:

$$Fuel_{partload} = Fuel_{design} \times FHeatPLC$$

where

$Fuel_{design}$ = fuel consumption at design conditions, in Btu/h, and

$FHeatPLC$ = fuel heating part-load efficiency curve determined in accordance with Sentence (2).

2) The fuel heating part-load efficiency curve, $FHeatPLC$, shall be calculated using the following equation:

$$FHeatPLC = a + b \times \frac{Q_{partload}}{Q_{design}} + c \times \left(\frac{Q_{partload}}{Q_{design}} \right)^2$$

where

$Q_{partload}$ = *boiler* capacity at part-load conditions, in Btu/h,

Q_{design} = *boiler* capacity at design conditions, in Btu/h, and

a, b, c = applicable coefficients from Table 8.4.5.2.-A.

Table 8.4.5.2.-A
Coefficients Used in the Calculation of FHeatPLC for Condensing and Non-Condensing Boilers
 Forming Part of Sentence 8.4.5.2.(2)

Type of Boiler	Coefficients for Calculation of FHeatPLC		
	a	b	c
Non-condensing	0.082597	0.996764	-0.079361
Condensing	0.00533	0.904	0.09066

3) For modulating *boilers*, values for $Q_{\text{partload}}/Q_{\text{design}}$ and corresponding values for FHeatPLC shall be those listed in Table 8.4.5.2.-B.

Table 8.4.5.2.-B
Values for Q_{partload} , Q_{rated} and Q_{design} and FHeatPLC for Modulating Boilers and Furnaces
 Forming Part of Sentences 8.4.5.2.(3) and 8.4.5.3.(3)

Q_{partload} , Q_{rated} and Q_{design} (Part-Load Ratio)	FHeatPLC
0.1	0.118
0.2	0.209
0.3	0.308
0.4	0.407
0.5	0.506
0.6	0.605
0.7	0.704
0.8	0.802
0.9	0.901
1	1

8.4.5.3. Furnace

1) The fuel consumption at part-load conditions, $\text{Fuel}_{\text{partload}}$, in Btu/h, of the reference condensing or atmospheric *furnace* shall be derived by applying an adjustment factor to the fuel consumption at rated conditions:

$$\text{Fuel}_{\text{partload}} = \text{Fuel}_{\text{rated}} \times \text{FHeatPLC}$$

where

$\text{Fuel}_{\text{rated}}$ = fuel consumption at rated conditions, in Btu/h, and

FHeatPLC = fuel heating part-load efficiency curve determined in accordance with Sentence (2).

2) The fuel heating part-load efficiency curve, FHeatPLC, shall be calculated using the following equation:

$$\text{FHeatPLC} = a + b \times \frac{Q_{\text{partload}}}{Q_{\text{rated}}} + c \times \left(\frac{Q_{\text{partload}}}{Q_{\text{rated}}} \right)^2$$

where

Q_{partload} = *furnace* capacity at part-load conditions, in Btu/h,

Q_{rated} = *furnace* capacity at rated conditions, in Btu/h, and

a, b, c = applicable coefficients from Table 8.4.5.3.

Table 8.4.5.3.
Coefficients Used in the Calculation of FHeatPLC for Condensing and Atmospheric Furnaces
 Forming Part of Sentence 8.4.5.3.(2)

Type of Furnace	Coefficients for Calculation of FHeatPLC		
	a	b	c
Atmospheric	0.0186100	1.0942090	-0.1128190
Condensing	0.00533	0.904	0.09066

3) For modulating furnaces, values for $Q_{partload}/Q_{rated}$ and corresponding values for FHeatPLC shall be those listed in Table 8.4.5.2.-B.

8.4.5.4. Direct-Expansion Cooling Equipment

1) The part-load performance characteristics of the reference electric direct-expansion (DX) coil cooling equipment shall be adjusted for cooling capacity by applying Sentence (2) and adjusted for power draw by applying Sentence (4).

2) The available total cooling capacity, $Q_{available}$, in Btu/h, of the reference electric DX coil as a function of present evaporator and condenser conditions shall be calculated using the following equation:

$$Q_{available} = CAP_FT_{EDX} \times Q_{rated}$$

where

CAP_FT_{EDX} = cooling capacity adjustment determined in accordance with Sentence (3), and

Q_{rated} = rated capacity at AHRI test conditions, in Btu/h.

3) The cooling capacity adjustment, CAP_FT_{EDX} , shall be calculated using the following equation:

$$CAP_FT_{EDX} = a + (b \times t_{wb}) + (c \times t_{wb}^2) + (d \times t_{odb}) + (e \times t_{odb}^2) + (f \times t_{wb} \times t_{odb})$$

where

t_{wb} = entering coil wet-bulb temperature, in °F,

t_{odb} = except as provided in Sentence (8), outdoor-air dry-bulb temperature, in °F,

a = 0.8740302,

b = -0.0011416,

c = 0.0001711,

d = -0.0029570,

e = 0.0000102, and

f = -0.0000592.

4) The power draw at specified operating conditions, $P_{operating}$, in kW, of the reference electric DX coil as a function of present evaporator and condenser conditions and part-load ratio shall be calculated using the following equation:

$$P_{operating} = P_{rated} \times EIR_FPLR \times EIR_FT \times CAP_FT_{EDX}$$

where

P_{rated} = rated power draw at AHRI test conditions, in kW,

EIR_FPLR = electric input ratio adjustment to rated efficiency due to changes in coil load determined in accordance with Sentence (5),

EIR_FT = electric input ratio adjustment to rated efficiency due to environmental variables determined in accordance with Sentence (7), and

CAP_FT_{EDX} = cooling capacity adjustment determined in accordance with Sentence (3).

5) The electric input ratio adjustment to the rated efficiency due to changes in coil load, EIR_FPLR, shall be calculated using the following equation:

$$\text{EIR_FPLR} = a + (b \times \text{PLR}) + (c \times \text{PLR}^2) + (d \times \text{PLR}^3)$$

where

PLR = part-load ratio based on available capacity (not rated capacity) determined in accordance with Sentence (6),

a = 0.2012301,

b = -0.0312175,

c = 1.9504979, and

d = -1.1205105.

6) The part-load ratio based on available capacity (not rated capacity), PLR, shall be calculated using the following equation:

$$\text{PLR} = \frac{Q_{\text{operating}}}{Q_{\text{available}}}$$

where

$Q_{\text{operating}}$ = present load on electric DX coil, in Btu/h, and

$Q_{\text{available}}$ = available capacity of electric DX coil at present evaporator and condenser conditions, in Btu/h, determined in accordance with Sentence (2).

7) The electric input ratio adjustment to the rated efficiency due to environmental variables, EIR_FT, shall be calculated using the following equation:

$$\text{EIR_FT} = a + (b \times t_{\text{wb}}) + (c \times t_{\text{wb}}^2) + (d \times t_{\text{odb}}) + (e \times t_{\text{odb}}^2) + (f \times t_{\text{wb}} \times t_{\text{odb}})$$

where

t_{wb} = entering coil wet-bulb temperature, in °F,

t_{odb} = except as provided in Sentence (8), outdoor-air dry-bulb temperature, in °F,

a = -1.0639310,

b = 0.0306584,

c = -0.0001269,

d = 0.0154213,

e = 0.0000497, and

f = -0.0002096.

8) If an air-cooled unit uses an evaporative condenser, the outdoor-air dry-bulb temperature, t_{odb} , used in Sentences (3) and (7) shall be the effective dry-bulb temperature of the air leaving the evaporative cooling unit.

8.4.5.5. Electric Chiller

1) The part-load performance characteristics of the reference electric chiller shall be adjusted for cooling capacity by applying Sentence (2) and adjusted for power draw by applying Sentence (4).

2) The available total cooling capacity, $Q_{\text{available}}$, in Btu/h, of the reference electric chiller as a function of present evaporator and condenser conditions shall be calculated using the following equation:

$$Q_{\text{available}} = \text{CAP_FT}_{\text{EC}} \times Q_{\text{rated}}$$

where

$\text{CAP_FT}_{\text{EC}}$ = cooling capacity adjustment determined in accordance with Sentence (3), and

Q_{rated} = rated capacity at AHRI test conditions, in Btu/h.

3) The cooling capacity adjustment, CAP_FT_{EC}, shall be calculated using the following equation:

$$CAP_FT_{EC} = a + (b \times t_{chws}) + (c \times t_{chws}^2) + (d \times t_{cws}) + (e \times t_{cws}^2) + (f \times t_{chws} \times t_{cws})$$

where

- t_{chws} = chilled water supply temperature, in °F,
- t_{cws} = condenser water supply temperature, in °F, and
- a, b, c, d, e, f = applicable coefficients from Table 8.4.5.5.-A.

Table 8.4.5.5.-A
Capacity Coefficients Used in the Calculation of CAP_FT_{EC}
Forming Part of Sentence 8.4.5.5.(3)

Type of Electric Chiller		Coefficients for Calculation of CAP_FT _{EC}					
		a	b	c	d	e	f
Air-cooled	Scroll	0.40070684	0.01861548	0.00007199	0.00177296	-0.00002014	-0.00008273
	Reciprocating	0.57617295	0.02063133	0.00007769	-0.00351183	0.00000312	-0.00007865
	Screw	-0.09464899	0.0383407	-0.00009205	0.00378007	-0.00001375	-0.00015464
	Centrifugal	-	-	-	-	-	-
Water-cooled	Scroll	0.36131454	0.01855477	0.00003011	0.00093592	-0.00001518	-0.00005481
	Reciprocating	0.58531422	0.01539593	0.00007296	-0.00212462	-0.00000715	-0.00004597
	Screw	0.332669598	0.00729116	-0.00049938	0.01598983	-0.00028254	0.00052346
	Centrifugal	-0.29861975	0.02996076	-0.00080125	0.01736268	-0.00032606	0.00063139

4) The power draw at specified operating conditions, P_{operating}, in kW, of the reference electric chiller as a function of present evaporator and condenser conditions and part-load ratio shall be calculated using the following equation:

$$P_{operating} = P_{rated} \times EIR_FPLR \times EIR_FT \times CAP_FT_{EC}$$

where

- P_{rated} = rated power draw at AHRI test conditions, in kW,
- EIR_FPLR = electric input ratio adjustment to rated efficiency due to changes in load determined in accordance with Sentence (5),
- EIR_FT = electric input ratio adjustment to rated efficiency due to environmental variables determined in accordance with Sentence (7), and
- CAP_FT_{EC} = cooling capacity adjustment determined in accordance with Sentence (3).

5) The electric input ratio adjustment to the rated efficiency due to changes in load, EIR_FPLR, shall be calculated using the following equation:

$$EIR_FPLR = a + (b \times PLR) + (c \times PLR^2)$$

where

- PLR = part-load ratio based on available capacity (not rated capacity) determined in accordance with Sentence (6), and
- a, b, c = applicable coefficients from Table 8.4.5.5.-B.

Table 8.4.5.5-B
Efficiency Coefficients Used in the Calculation of EIR_FPLR
 Forming Part of Sentence 8.4.5.5.(5)

Type of Electric Chiller		Coefficients for Calculation of EIR_FPLR		
		a	b	c
Air-cooled	Scroll	0.06369119	0.58488832	0.35280274
	Reciprocating	0.1143742	0.5459334	0.34229861
	Screw	0.03648722	0.73474298	0.21994748
	Centrifugal	–	–	–
Water-cooled	Scroll	0.04411957	0.64036703	0.31955532
	Reciprocating	0.08144133	0.41927141	0.49939604
	Screw	0.33018833	0.23554291	0.46070828
	Centrifugal	0.17149273	0.58820208	0.23737257

6) The part-load ratio based on available capacity, PLR, shall be calculated using the following equation:

$$PLR = \frac{Q_{\text{operating}}}{Q_{\text{available}}}$$

where

$Q_{\text{operating}}$ = present load on electric chiller, in Btu/h, and

$Q_{\text{available}}$ = available capacity of electric chiller at present evaporator and condenser conditions, in Btu/h, determined in accordance with Sentence (2).

7) The electric input ratio adjustment to the rated efficiency due to environmental variables, EIR_FT, shall be calculated using the following equation:

$$EIR_{FT} = a + (b \times t_{chws}) + (c \times t_{chws}^2) + (d \times t_{cws}) + (e \times t_{cws}^2) + (f \times t_{chws} \times t_{cws})$$

where

t_{chws} = chilled water supply temperature, in °F,

t_{cws} = condenser water supply temperature, in °F, and

a, b, c, d, e, f = applicable coefficients from Table 8.4.5.5.-C.

Table 8.4.5.5-C
Efficiency Coefficients Used in the Calculation of EIR_FT
 Forming Part of Sentence 8.4.5.5.(7)

Type of Electric Chiller		Coefficients for Calculation of EIR_FT					
		a	b	c	d	e	f
Air-cooled	Scroll	0.99006553	-0.00584144	0.00016454	-0.00661136	0.00016808	-0.00022501
	Reciprocating	0.66534403	-0.01383821	0.00014736	0.00712808	0.00004571	-0.00010326
	Screw	0.013545636	0.02292946	-0.00016107	-0.00235396	0.00012991	-0.00018585
	Centrifugal	–	–	–	–	–	–
Water-cooled	Scroll	1.00121431	-0.01026981	0.00016703	-0.0128136	0.00014613	-0.00021959
	Reciprocating	0.46140041	-0.0882156	0.00008223	0.00926607	0.00005722	-0.00011594
	Screw	0.66625406	0.00068584	0.00028496	-0.00341677	0.00025484	-0.00048195
	Centrifugal	0.51777196	-0.00400363	0.00002026	0.00698793	0.0000829	-0.00015467

8.4.5.6. Cooling Tower

1) The part-load performance characteristics of the reference cooling tower shall be adjusted for cooling capacity by applying Sentence (2).

2) The available total cooling capacity, $Q_{available}$, in Btu/h, of the reference cooling tower as a function of present outdoor-air wet-bulb, condenser water supply and condenser water return temperatures shall be calculated using the following equation:

$$Q_{available} = Q_{rated} \times FWB \times \frac{t_R}{10}$$

where

Q_{rated} = rated cooling capacity at CTI test conditions, in Btu/h,

FWB = ratio of available capacity to rated capacity, in gpm/gpm, determined in accordance with Sentence (3), and

t_R = tower range, in °F, determined in accordance with Sentence (5).

3) The ratio of available capacity to rated capacity, FWB , shall be calculated using the following equation:

$$FWB = a + (b \times FRA) + (c \times FRA^2) + (d \times t_{cwb}) + (e \times t_{cwb}^2) + (f \times FRA \times t_{cwb})$$

where

FRA = intermediate capacity curve based on range and approach determined in accordance with Sentence (4),

t_{cwb} = outdoor-air wet-bulb temperature, in °F,

$a = 0.60531402$,

$b = -0.03554536$,

$c = 0.00804083$,

$d = -0.02860259$,

$e = 0.00024972$, and

$f = 0.00490857$.

4) The intermediate capacity curve based on range and approach, FRA , shall be calculated using the following equation:

$$FRA = \frac{-d - (f \times t_R) + \sqrt{[d + (f \times t_R)]^2 - 4 \times e \times [a + (b \times t_R) + (c \times t_R^2) - t_A]}}{2 \times e}$$

where

t_R = tower range, in °F, determined in accordance with Sentence (5),

t_A = tower approach, in °F, determined in accordance with Sentence (6),

$a = -2.22888899$,

$b = 0.16679543$,

$c = -0.01410247$,

$d = 0.03222333$,

$e = 0.18560214$, and

$f = 0.24251871$.

5) The tower range, t_R , shall be calculated using the following equation:

$$t_R = t_{cwr} - t_{cws}$$

where

t_{cwr} = condenser water return temperature, in °F, and

t_{cws} = condenser water supply temperature, in °F.

6) The tower approach, t_A , shall be calculated using the following equation:

$$t_A = t_{cws} - t_{owb}$$

where

t_{cws} = condenser water supply temperature, in °F, and
 t_{owb} = outdoor-air wet-bulb temperature, in °F.

8.4.5.7. Electric Air-Source Heat Pump

1) The heating part-load performance characteristics of the reference electric air-source heat pump shall be adjusted for heating capacity by applying Sentence (2) and adjusted for power draw by applying Sentence (4).

2) The available heating capacity, $Q_{available}$, in Btu/h, of the reference heat pump as a function of present evaporator and condenser conditions shall be calculated using the following equation:

$$Q_{available} = CAP_FT_{EAS} \times Q_{rated}$$

where

CAP_FT_{EAS} = heating capacity adjustment determined in accordance with Sentence (3), and

Q_{rated} = rated capacity at AHRI test conditions, in Btu/h.

3) The heating capacity adjustment, CAP_FT_{EAS} , shall be calculated using the following equation:

$$CAP_FT_{EAS} = a + (b \times t_{odb}) + (c \times t_{odb}^2) + (d \times t_{odb}^3)$$

where

t_{odb} = outdoor-air dry-bulb temperature, in °F,

$a = 0.2536714$,

$b = 0.0104351$,

$c = 0.0001861$, and

$d = -0.0000015$.

4) The power draw, $P_{operating}$, in kW, of the reference heat pump as a function of present evaporator and condenser conditions and part-load ratio shall be calculated using the following equation:

$$P_{operating} = P_{rated} \times EIR_FPLR \times EIR_FT \times CAP_FT_{EAS}$$

where

P_{rated} = rated power draw at AHRI test conditions, in kW,

EIR_FPLR = electric input ratio adjustment to rated efficiency due to changes in heat pump load determined in accordance with Sentence (5),

EIR_FT = electric input ratio adjustment to rated efficiency due to environmental variables determined in accordance with Sentence (7), and

CAP_FT_{EAS} = heating capacity adjustment determined in accordance with Sentence (3).

5) The electric input ratio adjustment to the rated efficiency due to changes in heat pump load, EIR_FPLR , shall be calculated using the following equation:

$$EIR_FPLR = a + (b \times PLR) + (c \times PLR^2) + (d \times PLR^3)$$

where

PLR = part-load ratio based on available capacity (not rated capacity) determined in accordance with Sentence (6),

$a = 0.0856522$,

$b = 0.9388137$,

$c = -0.1834361$, and

$d = 0.1589702$.

6) The part-load ratio based on available capacity, PLR, shall be calculated using the following equation:

$$PLR = \frac{Q_{operating}}{Q_{available}}$$

where

$Q_{operating}$ = present load on heat pump, in Btu/h, and
 $Q_{available}$ = available capacity of heat pump at present evaporator and condenser conditions, in Btu/h, determined in accordance with Sentence (2).

7) The electric input ratio adjustment to the rated efficiency due to environmental variables, EIR_FT, shall be calculated using the following equation:

$$EIR_FT = a + (b \times t_{odb}) + (c \times t_{odb}^2) + (d \times t_{odb}^3)$$

where

t_{odb} = outdoor-air dry-bulb temperature, in °F,
 a = 2.4600298,
 b = -0.0622539,
 c = 0.0008800, and
 d = -0.0000046.

8.4.5.8. Absorption Chiller

1) The part-load performance characteristics of the reference absorption chiller shall be adjusted for cooling capacity by applying Sentence (2) and adjusted for fuel consumption by applying Sentences (4) and (8).

2) The available total cooling capacity, $Q_{available}$, in Btu/h, of the reference absorption chiller as a function of present evaporator and condenser conditions shall be calculated using the following equation:

$$Q_{available} = CAP_FT_{AC} \times Q_{rated}$$

where

CAP_FT_{AC} = cooling capacity adjustment determined in accordance with Sentence (3),
 and
 Q_{rated} = rated capacity at AHRI test conditions, in Btu/h.

3) The cooling capacity adjustment, CAP_FT_{AC} , shall be calculated using the following equation:

$$CAP_FT_{AC} = a + (b \times t_{chws}) + (c \times t_{chws}^2) + (d \times t_{cws}) + (e \times t_{cws}^2) + (f \times t_{chws} \times t_{cws})$$

where

t_{chws} = chilled water supply temperature, in °F,
 t_{cws} = condenser water supply temperature, in °F, and
 a, b, c, d, e, f = applicable coefficients from Table 8.4.5.8.-A.

Table 8.4.5.8.-A
Capacity Coefficients Used in the Calculation of CAP_FT_{AC}
 Forming Part of Sentence 8.4.5.8.(3)

Type of Absorption Chiller	Coefficients for Calculation of CAP_FT _{AC}					
	a	b	c	d	e	f
Steam-driven, single-effect	0.723412	0.079006	0.000897	-0.025285	-0.000048	0.000276
Steam-driven, double-effect	-0.816039	-0.038707	0.00045	0.071491	-0.000636	0.000312
Direct-fired	1	0	0	0	0	0

4) The fuel consumption at specified operating conditions, Fuel_{partload}, in Btu/h, of a steam-driven, single- or double-effect absorption chiller as a function of present evaporator and condenser conditions and part-load ratio shall be calculated using the following equation:

$$\text{Fuel}_{\text{partload}} = \text{Fuel}_{\text{rated}} \times \text{FIR_FPLR} \times \text{FIR_FT} \times \text{CAP_FT}_{\text{AC}}$$

where

Fuel_{rated} = rated fuel consumption at AHRI test conditions, in Btu/h,

FIR_FPLR = fuel input ratio adjustment to rated efficiency due to changes in load determined in accordance with Sentence (5),

FIR_FT = fuel input ratio adjustment to rated efficiency due to environmental variables determined in accordance with Sentence (7), and

CAP_FT_{AC} = cooling capacity adjustment determined in accordance with Sentence (3).

5) The fuel input ratio adjustment to the rated efficiency due to changes in load, FIR_FPLR, shall be calculated using the following equation:

$$\text{FIR_FPLR} = a + (b \times \text{PLR}) + (c \times \text{PLR}^2)$$

where

PLR = part-load ratio based on available capacity (not rated capacity) determined in accordance with Sentence (6), and

a, b, c = applicable coefficients from Table 8.4.5.8.-B.

Table 8.4.5.8.-B
Efficiency Coefficients Used in the Calculation of FIR_FPLR
 Forming Part of Sentence 8.4.5.8.(5)

Type of Absorption Chiller	Coefficients for Calculation of FIR_FPLR		
	a	b	c
Steam-driven, single-effect	0.098585	0.58385	0.560658
Steam-driven, double-effect	0.013994	1.240449	-0.914883

6) The part-load ratio based on available capacity, PLR, shall be calculated using the following equation:

$$\text{PLR} = \frac{Q_{\text{operating}}}{Q_{\text{available}}}$$

where

Q_{operating} = present load on absorption chiller, in Btu/h, and

$Q_{available}$ = available capacity of absorption chiller at present evaporator and condenser conditions, in Btu/h, determined in accordance with Sentence (2).

7) The fuel input ratio adjustment to the rated efficiency due to environmental variables, FIR_FT, shall be calculated using the following equation:

$$FIR_FT = a + (b \times t_{chws}) + (c \times t_{chws}^2) + (d \times t_{cws}) + (e \times t_{cws}^2) + (f \times t_{chws} \times t_{cws})$$

where

t_{chws} = chilled water supply temperature, in °F,
 t_{cws} = condenser water supply temperature, in °F, and
 a, b, c, d, e, f = applicable coefficients from Table 8.4.5.8.-C.

Table 8.4.5.8.-C
Efficiency Coefficients Used in the Calculation of FIR_FT
 Forming Part of Sentence 8.4.5.8.(7)

Type of Absorption Chiller	Coefficients for Calculation of FIR_FT					
	a	b	c	d	e	f
Steam-driven, single-effect	0.652273	0	0	-0.000545	0.000055	0
Steam-driven, double-effect	1.65875	0	0	-0.29	0.00025	0

8) The fuel consumption at specified operating conditions, $Fuel_{partload}$, in Btu/h, of a direct-fired, double-effect absorption chiller as a function of present evaporator and condenser conditions and part-load ratio shall be calculated using the following equation:

$$Fuel_{partload} = Fuel_{rated} \times FIR_FPLR \times FIR_FT1 \times FIR_FT2 \times CAP_FT_{AC}$$

where

$Fuel_{rated}$ = rated fuel consumption at AHRI test conditions, in Btu/h,
 FIR_FPLR = fuel input ratio adjustment to rated efficiency due to changes in load determined in accordance with Sentence (9),
 FIR_FT1 = first fuel input ratio adjustment to rated efficiency due to environmental variables determined in accordance with Sentence (10),
 FIR_FT2 = second fuel input ratio adjustment to rated efficiency due to environmental variables determined in accordance with Sentence (11), and
 CAP_FT_{AC} = cooling capacity adjustment determined in accordance with Sentence (3).

9) The fuel input ratio adjustment to the rated efficiency due to changes in load, FIR_FPLR , shall be calculated using the following equation:

$$FIR_FPLR = a + (b \times PLR) + (c \times PLR^2)$$

where

PLR = part-load ratio based on available capacity (not rated capacity) determined in accordance with Sentence (6),
 a = 0.13551150,
 b = 0.61798084, and
 c = 0.24651277.

10) The first fuel input ratio adjustment to the rated efficiency due to environmental variables, FIR_FT1 , shall be calculated using the following equation:

$$FIR_FT1 = a_1 + (b_1 \times t_{chws}) + (c_1 \times t_{chws}^2)$$

where

$$\begin{aligned} t_{\text{chws}} &= \text{chilled water supply temperature, in } ^\circ\text{F}, \\ a_1 &= 4.42871284, \\ b_1 &= -0.13298607, \text{ and} \\ c_1 &= 0.00125331. \end{aligned}$$

11) The second fuel input ratio adjustment to the rated efficiency due to environmental variables, FIR_FT2, shall be calculated using the following equation:

$$\text{FIR_FT2} = a_2 + (b_2 \times t_{\text{cws}}) + (c_2 \times t_{\text{cws}}^2)$$

where

$$\begin{aligned} t_{\text{cws}} &= \text{condenser water supply temperature, in } ^\circ\text{F}, \\ a_2 &= 0.86173749, \\ b_2 &= -0.00708917, \text{ and} \\ c_2 &= 0.0010251. \end{aligned}$$

8.4.5.9. Fuel-Fired Service Water Heater

1) The fuel consumption at part-load conditions, $\text{Fuel}_{\text{partload}}$, in Btu/h, of the reference fuel-fired *service water* heater shall be derived by applying an adjustment factor to the fuel consumption at full load:

$$\text{Fuel}_{\text{partload}} = \text{Fuel}_{\text{design}} \times \text{FHeatPLC}$$

where

$\text{Fuel}_{\text{design}}$ = fuel consumption at design conditions, in Btu/h, and
 FHeatPLC = fuel heating part-load efficiency curve determined in accordance with Sentence (2).

2) The fuel heating part-load efficiency curve, FHeatPLC , shall be calculated using the following equation:

$$\text{FHeatPLC} = a + b \times \frac{Q_{\text{partload}}}{Q_{\text{design}}} + c \times \left(\frac{Q_{\text{partload}}}{Q_{\text{design}}} \right)^2$$

where

$$\begin{aligned} Q_{\text{partload}} &= \text{service water heater capacity at part-load conditions, in Btu/h}, \\ Q_{\text{design}} &= \text{service water heater capacity at design conditions, in Btu/h}, \\ a &= 0.021826, \\ b &= 0.977630, \text{ and} \\ c &= 0.000543. \end{aligned}$$

Section 8.5. Objective and Functional Statements

8.5.1. Objective and Functional Statements

8.5.1.1. Attributions to Acceptable Solutions

1) For the purpose of compliance with this Code as required in Clause 1.2.1.1.(1)(b) of Division A, the objective and functional statements attributed to the acceptable solutions in this Part shall be the objective and functional statements listed in Table 8.5.1.1. (See Note A-1.1.3.1.(1).)

Table 8.5.1.1.
Objectives and Functional Statements Attributed to the
Acceptable Solutions in Part 8
 Forming Part of Sentence 8.5.1.1.(1)

Provision	Functional Statements and Objectives ⁽¹⁾
8.1.1.2. Application	
(1)	[F99-OE1.1]
(3)	[F99-OE1.1]
(4)	[F99-OE1.1]
8.4.1.1. General	
(1)	[F99-OE1.1]
(2)	[F92,F93,F94,F95,F96,F97,F98,F99,F100-OE1.1]
8.4.1.2. Determination of Compliance	
(2)	[F92,F93,F94,F95,F96,F97,F98,F99,F100-OE1.1]
(3)	[F99-OE1.1]
(4)	[F99-OE1.1]
(5)	[F99-OE1.1]
8.4.1.4. Treatment of Additions	
(1)	[F99-OE1.1]
(2)	[F99-OE1.1]
(3)	[F99-OE1.1]
8.4.2.1. General	
(1)	[F99-OE1.1]
8.4.2.2. Calculation Methods	
(1)	[F99-OE1.1]
(2)	[F99-OE1.1]
(3)	[F99-OE1.1]
(4)	[F99-OE1.1]
8.4.2.3. Climatic Data	
(1)	[F99-OE1.1]
(2)	[F99-OE1.1]
8.4.2.4. Thermal Mass	
(1)	[F99-OE1.1]
8.4.2.5. Space Temperature	
(1)	[F99-OE1.1]
8.4.2.6. Heat Transfer Between Thermal Blocks	
(1)	[F99-OE1.1]
(2)	[F99-OE1.1]
8.4.2.7. Internal and Service Water Heating Loads	
(1)	[F99-OE1.1]
(2)	[F99-OE1.1]
(3)	[F99-OE1.1]
(4)	[F99-OE1.1]
(5)	[F99-OE1.1]
8.4.2.8. Building Envelope	
(1)	[F99-OE1.1]

Table 8.5.1.1. (Continued)

Provision	Functional Statements and Objectives ⁽¹⁾
(2)	[F99-OE1.1]
(3)	[F99-OE1.1]
(4)	[F99-OE1.1]
(5)	[F99-OE1.1]
(6)	[F99-OE1.1]
(7)	[F99-OE1.1]
(8)	[F99-OE1.1]
(9)	[F99-OE1.1]
(10)	[F99-OE1.1]
8.4.2.9. Air Leakage	
(1)	[F99-OE1.1]
(2)	[F99-OE1.1]
8.4.2.10. HVAC Systems Calculations	
(1)	[F99-OE1.1]
(2)	[F99-OE1.1]
(3)	[F99-OE1.1]
(4)	[F99-OE1.1]
(5)	[F99-OE1.1]
8.4.3.1. General	
(2)	[F99-OE1.1]
(3)	[F99-OE1.1]
(4)	[F99-OE1.1]
(5)	[F99-OE1.1]
(7)	[F99-OE1.1]
(8)	[F99-OE1.1]
8.4.3.2. Operating Schedules, Internal Loads, Service Water Heating Loads and Set-point Temperature	
(1)	[F99-OE1.1]
(2)	[F99-OE1.1]
(3)	[F99-OE1.1]
8.4.3.3. Building Envelope Components	
(1)	[F99-OE1.1]
(2)	[F99-OE1.1]
(3)	[F99-OE1.1]
8.4.3.4. Interior Lighting	
(1)	[F99-OE1.1]
(2)	[F99-OE1.1]
(3)	[F99-OE1.1]
(4)	[F99-OE1.1]
8.4.3.5. Purchased Energy	
(2)	[F99-OE1.1]
(3)	[F99-OE1.1]
(4)	[F99-OE1.1]

Table 8.5.1.1. (Continued)

Provision	Functional Statements and Objectives ⁽¹⁾
(5)	[F99-OE1.1]
8.4.3.6. Outdoor Air	
(1)	[F99-OE1.1]
8.4.3.7. Space Temperature Control	
(1)	[F99-OE1.1]
8.4.3.8. Part-Load Performance Curves	
(1)	[F99-OE1.1]
(2)	[F99-OE1.1]
8.4.3.9. Ice Plants	
(1)	[F99-OE1.1]
8.4.4.1. General	
(2)	[F99-OE1.1]
(3)	[F99-OE1.1]
(4)	[F99-OE1.1]
(5)	[F99-OE1.1]
(6)	[F99-OE1.1]
(7)	[F99-OE1.1]
8.4.4.2. Operating Schedules, Internal Loads, Service Water Heating Loads and Set-point Temperature	
(1)	[F99-OE1.1]
(2)	[F99-OE1.1]
(3)	[F99-OE1.1]
8.4.4.3. Building Envelope Components	
(1)	[F99-OE1.1]
(2)	(a) [F99-OE1.1]
(3)	[F99-OE1.1]
(4)	[F99-OE1.1]
(5)	[F99-OE1.1]
(6)	[F99-OE1.1]
(7)	[F99-OE1.1]
(8)	[F99-OE1.1]
8.4.4.4. Thermal Mass	
(2)	[F99-OE1.1]
8.4.4.5. Lighting	
(1)	[F99-OE1.1]
(2)	[F99-OE1.1]
(3)	[F99-OE1.1]
(4)	[F99-OE1.1]
(5)	[F99-OE1.1]
(6)	[F99-OE1.1]
(7)	[F99-OE1.1]
(8)	[F99-OE1.1]
(9)	[F99-OE1.1]

Table 8.5.1.1. (Continued)

Provision	Functional Statements and Objectives ⁽¹⁾
(10)	[F99-OE1.1]
(11)	[F99-OE1.1]
(12)	[F99-OE1.1]
8.4.4.6. Purchased Energy	
(1)	[F99-OE1.1]
(2)	[F99-OE1.1]
(3)	[F99-OE1.1]
(4)	[F99-OE1.1]
8.4.4.7. HVAC System Selection	
(1)	[F99-OE1.1]
(3)	[F99-OE1.1]
(4)	[F99-OE1.1]
8.4.4.8. Equipment Oversizing	
(1)	[F99-OE1.1]
(2)	[F99-OE1.1]
8.4.4.9. Heating System	
(1)	[F99-OE1.1]
(3)	[F99-OE1.1]
(4)	[F99-OE1.1]
(5)	[F99-OE1.1]
(6)	[F99-OE1.1]
(7)	[F99-OE1.1]
(8)	[F99-OE1.1]
8.4.4.10. Cooling Systems	
(1)	[F99-OE1.1]
(3)	[F99-OE1.1]
(4)	[F99-OE1.1]
(5)	[F99-OE1.1]
(6)	[F99-OE1.1]
(7)	[F99-OE1.1]
(8)	[F99-OE1.1]
(9)	[F99,F100-OE1.1]
8.4.4.11. Cooling Tower Systems	
(1)	[F99-OE1.1]
(2)	[F99-OE1.1]
(3)	[F99-OE1.1]
(4)	[F99-OE1.1]
(5)	[F99-OE1.1]
(6)	[F99-OE1.1]
(7)	[F99-OE1.1]
8.4.4.12. Cooling with Outside Air	
(1)	[F99-OE1.1]

Table 8.5.1.1. (Continued)

Provision	Functional Statements and Objectives ⁽¹⁾
8.4.4.13. Heat Pumps	
(1)	[F99-OE1.1]
(2)	[F99-OE1.1]
8.4.4.14. Hydronic Pumps	
(1)	[F99-OE1.1]
(2)	[F99-OE1.1]
(3)	[F99-OE1.1]
(4)	[F99-OE1.1]
(5)	[F99-OE1.1]
(6)	[F99-OE1.1]
8.4.4.15. Outdoor Air	
(1)	[F99-OE1.1]
(2)	[F99-OE1.1]
8.4.4.16. Space Temperature Control	
(1)	[F99-OE1.1]
(2)	[F99-OE1.1]
8.4.4.17. Fans	
(1)	[F99-OE1.1]
(2)	[F99-OE1.1]
(3)	[F99-OE1.1]
(4)	[F99-OE1.1]
(5)	[F99-OE1.1]
8.4.4.18. Supply Air Systems	
(1)	[F99-OE1.1]
(2)	[F99-OE1.1]
(3)	[F99-OE1.1]
(4)	[F99-OE1.1]
(5)	[F99-OE1.1]
(6)	[F99-OE1.1]
8.4.4.19. Energy Recovery Systems	
(1)	[F99,F100-OE1.1]
(2)	[F99,F100-OE1.1]
(3)	[F100-OE1.1]
8.4.4.20. Service Water Heating Systems	
(1)	[F99-OE1.1]
(2)	[F99-OE1.1]
(3)	[F99-OE1.1]
(4)	[F99-OE1.1]
(5)	[F99-OE1.1]
(6)	[F99-OE1.1]
(7)	[F99-OE1.1]
(8)	[F99-OE1.1]
(9)	[F99-OE1.1]

Table 8.5.1.1. (Continued)

Provision	Functional Statements and Objectives ⁽¹⁾
8.4.5.2. Boiler	
(1)	[F99-OE1.1]
(2)	[F99-OE1.1]
(3)	[F99-OE1.1]
8.4.5.3. Furnace	
(1)	[F99-OE1.1]
(2)	[F99-OE1.1]
(3)	[F99-OE1.1]
8.4.5.4. Direct-Expansion Cooling Equipment	
(2)	[F99-OE1.1]
(3)	[F99-OE1.1]
(4)	[F99-OE1.1]
(5)	[F99-OE1.1]
(6)	[F99-OE1.1]
(7)	[F99-OE1.1]
(8)	[F99-OE1.1]
8.4.5.5. Electric Chiller	
(2)	[F99-OE1.1]
(3)	[F99-OE1.1]
(4)	[F99-OE1.1]
(5)	[F99-OE1.1]
(6)	[F99-OE1.1]
(7)	[F99-OE1.1]
8.4.5.6. Cooling Tower	
(2)	[F99-OE1.1]
(3)	[F99-OE1.1]
(4)	[F99-OE1.1]
(5)	[F99-OE1.1]
(6)	[F99-OE1.1]
8.4.5.7. Electric Air-Source Heat Pump	
(2)	[F99-OE1.1]
(3)	[F99-OE1.1]
(4)	[F99-OE1.1]
(5)	[F99-OE1.1]
(6)	[F99-OE1.1]
(7)	[F99-OE1.1]
8.4.5.8. Absorption Chiller	
(2)	[F99-OE1.1]
(3)	[F99-OE1.1]
(4)	[F99-OE1.1]
(5)	[F99-OE1.1]
(6)	[F99-OE1.1]
(7)	[F99-OE1.1]

Table 8.5.1.1. (Continued)

Provision	Functional Statements and Objectives ⁽¹⁾
(8)	[F99-OE1.1]
(9)	[F99-OE1.1]
(10)	[F99-OE1.1]
(11)	[F99-OE1.1]
8.4.5.9. Fuel-Fired Service Water Heater	
(1)	[F99-OE1.1]
(2)	[F99-OE1.1]

Notes to Table 8.5.1.1.:

⁽¹⁾ See Parts 2 and 3 of Division A.

Notes to Part 8

Building Energy Performance Compliance Path

A-8.4.1.4. Treatment of Additions. When the addition is considered by itself, its dimensions and thermal characteristics are used without considering the existing building. The wall or floor or virtual plane separating the addition from the existing building is considered for what it is — a building component separating two conditioned spaces: heat exchange across the building component is not taken into consideration unless the design calls for a temperature differential across it or the existing building is an unconditioned space. Only the new mechanical and electrical systems that are part of the addition or serve only the addition are accounted for in the calculations; existing central plants are not accounted for.

When the addition is considered together with the existing building, energy analyses of the whole building are required, including existing parts and additions. Some existing parts of the building, such as existing central plants, may not be needed for the comparison of the proposed and reference buildings and may not have to be simulated. It may be advantageous to consider the whole building only in cases where considering the addition by itself would result in a very high fenestration-to-wall ratio. Existing portions of the building need not be upgraded to meet Code requirements; the compliance calculations are expected to use the characteristics of the existing components in the analyses of both the proposed and reference buildings.

However, as implied in Clause 8.4.1.4.(1)(b), the performance path cannot be used to allow the upgrading of existing components of the building to compensate for components of the addition that do not satisfy the prescriptive requirements of the Code: for example, existing windows cannot be replaced with new ones to compensate for a building envelope on the addition with a high thermal transmittance. Even if the windows in the existing building are to be upgraded at the same time as the addition is being constructed, the characteristics of the existing windows will be used in both analyses. Thus, energy savings in the existing parts of the building cannot be used to offset any shortcomings of the addition's components.

The degree of precision required in determining the thermal characteristics of existing components, as required in Clause 8.4.1.4.(2)(b) and Sentence 8.4.1.4.(3), is not high, since the characteristics of the existing parts of the building remain identical in both simulations. In fact, the existing parts of the building get compared to themselves.

A-8.4.1.4.(2)(b) Characteristics of Existing Equipment. Clause 8.4.1.4.(2)(b) is intended to direct Code users to apply the standards and test methods listed in Parts 5 and 6.

A-8.4.2.2.(1)(g) Auxiliary HVAC Equipment. This category of equipment generally includes cooling tower fans, humidifiers and other devices that do not directly fall under one of the other categories listed in Sentence 8.4.2.2.(1).

A-8.4.2.3. Climatic Data. The following data formats are acceptable to represent climatic data:

- TMY2 (Typical Meteorological Year 2),
- TMY3 (Typical Meteorological Year 3),
- WYEC2 (Weather Year for Energy Calculation 2),
- CWEC (Canadian Weather Year for Energy Calculations),
- IWEC (International Weather for Energy Calculations), and
- CWEEDS (Canadian Weather Energy and Engineering Datasets).

These Notes are included for explanatory purposes only and do not form part of the requirements. The number that introduces each Note corresponds to the applicable requirement in this Part.

A-8.4.2.7.(1)

The CWEC represent average heating and cooling degree-days which impact heating and cooling loads in buildings. The CWEC follow the ASHRAE WYEC2 format and were derived from the CWEEDS of hourly weather information for Canada from the 1953-1995 period of record. The CWEC are available from Environment and Climate Change Canada at www.climate.weather.gc.ca/prods_servs/engineering_e.html.

Where climatic data for a target location are not available, climatic data for a representative alternative location should be selected based on the following considerations: same climatic zone, same geographic area or characteristics, heating degree-days (HDD) of the alternative location are within 10% of the target location's HDD, and the January 1% heating design criteria of the alternative location is within 2°C of the target location's same criteria (see Table C-1). Where several alternative locations are representative of the climatic conditions at the target location, their proximity to the target location should also be a consideration.

A-8.4.2.7.(1) Internal and Service Water Heating Loads. Common internal loads include loads due to lighting, presence of occupants, equipment that is directly operated by the occupants such as personal computers, equipment that operates automatically such as computer servers, and other non-energy-consuming loads such as food to be frozen in a freezer. Internal loads usually generate sensible, latent and/or radiant heat gains.

Except for lighting, internal loads are not regulated within the scope of the NECB. However, because they add cooling and/or heating loads to the building's HVAC and service water heating systems, internal loads representative of the building type or space function should be included in the compliance calculations in order to correctly evaluate part-load performance of the HVAC and service water heating systems and, by extension, the energy consumption of the proposed and reference buildings. The internal loads must be modeled identically in the proposed and reference building energy models; only the energy consumed by the equipment and systems regulated by the NECB can be modeled differently in the proposed and reference buildings.

Note A-8.4.3.2.(2) provides default internal loads and associated hourly profiles for occupants and receptacle equipment that are representative of different building types and space functions. While any internal load values are permitted to be used, those default values should be used in the absence of better information.

The default values for receptacle equipment generally represent common electrical equipment directly operated by the occupants, as well as some automatically operated electrical equipment commonly found in the building types listed. For example, for an office building, the default value implicitly includes equipment such as office computer servers, photocopiers, printers, escalators, elevators, etc., but does not include the servers of main data centres.

Reasonable professional judgment should be applied in evaluating whether less common internal loads are correctly represented or not in the default values and profiles for receptacle equipment. These less common loads are generally associated with commercial and industrial operations and processes, such as

- manufacturing machinery in an industrial building
- medical imaging equipment in a hospital
- computer servers in a data centre of an office building
- swimming pool water heating in a recreation centre
- cooking appliances and refrigeration equipment in a commercial kitchen or restaurant

Generally, if the default values provided in Note A-8.4.3.2.(2) appear too small compared to the actual expected internal loads, some commercial and/or industrial operations and/or processes will not be correctly represented.

A-8.4.2.9.(2) Total Area of the Building Envelope. The total area of the building envelope, S , is typically measured at the plane of the building's air barrier assemblies and includes the surface areas of doors, windows and the air control layer in the opaque building assemblies.

A-8.4.3.2.(1) Operating Schedules. Tables A-8.4.3.2.(1)-A to A-8.4.3.2.(1)-I contain default values of operating schedules of building parameters for simulation purposes. These schedules may be used with Table A-8.4.3.2.(2)-B if more accurate information is not available. If the building or space type is not listed in Table A-8.4.3.2.(2)-A or A-8.4.3.2.(2)-B, the schedule that most closely corresponds to the occupancy of the proposed building or space should be used. See also Note A-8.4.4.2.(1).

Table A-8.4.3.2.(1)-A
Operating Schedule A

Day	Time of Day																							
	1a	2a	3a	4a	5a	6a	7a	8a	9a	10a	11a	12	1p	2p	3p	4p	5p	6p	7p	8p	9p	10p	11p	12
Occupants, fraction occupied																								
Mon - Fri	0	0	0	0	0	0	0.1	0.7	0.9	0.9	0.9	0.5	0.5	0.9	0.9	0.9	0.7	0.3	0.1	0.1	0.1	0.1	0	0
Sat	0	0	0	0	0	0	0	0	0	0	0	0	0	0	0	0	0	0	0	0	0	0	0	0
Sun	0	0	0	0	0	0	0	0	0	0	0	0	0	0	0	0	0	0	0	0	0	0	0	0
Lighting, fraction "ON"																								
Mon - Fri	0.05	0.05	0.05	0.05	0.05	0.05	0.3	0.8	0.9	0.9	0.9	0.9	0.9	0.9	0.9	0.9	0.8	0.5	0.3	0.3	0.1	0.1	0.05	0.05
Sat	0.05	0.05	0.05	0.05	0.05	0.05	0.05	0.05	0.05	0.05	0.05	0.05	0.05	0.05	0.05	0.05	0.05	0.05	0.05	0.05	0.05	0.05	0.05	0.05
Sun	0.05	0.05	0.05	0.05	0.05	0.05	0.05	0.05	0.05	0.05	0.05	0.05	0.05	0.05	0.05	0.05	0.05	0.05	0.05	0.05	0.05	0.05	0.05	0.05
Receptacle Equipment, fraction of load																								
Mon - Fri	0.2	0.2	0.2	0.2	0.2	0.2	0.3	0.8	0.9	0.9	0.9	0.9	0.9	0.9	0.9	0.9	0.9	0.5	0.3	0.3	0.2	0.2	0.2	0.2
Sat	0.2	0.2	0.2	0.2	0.2	0.2	0.2	0.2	0.2	0.2	0.2	0.2	0.2	0.2	0.2	0.2	0.2	0.2	0.2	0.2	0.2	0.2	0.2	0.2
Sun	0.2	0.2	0.2	0.2	0.2	0.2	0.2	0.2	0.2	0.2	0.2	0.2	0.2	0.2	0.2	0.2	0.2	0.2	0.2	0.2	0.2	0.2	0.2	0.2
Fans																								
Mon - Fri	Off	Off	Off	Off	Off	On	On	On	On	On	On	On	On	On	On	On	On	On	On	On	Off	Off	Off	Off
Sat	Off	Off	Off	Off	Off	Off	Off	Off	Off	Off	Off	Off	Off	Off	Off	Off	Off	Off	Off	Off	Off	Off	Off	Off
Sun	Off	Off	Off	Off	Off	Off	Off	Off	Off	Off	Off	Off	Off	Off	Off	Off	Off	Off	Off	Off	Off	Off	Off	Off
Cooling System, °C																								
Mon - Fri	Off	Off	Off	Off	Off	24	24	24	24	24	24	24	24	24	24	24	24	24	24	24	Off	Off	Off	Off
Sat	Off	Off	Off	Off	Off	Off	Off	Off	Off	Off	Off	Off	Off	Off	Off	Off	Off	Off	Off	Off	Off	Off	Off	
Sun	Off	Off	Off	Off	Off	Off	Off	Off	Off	Off	Off	Off	Off	Off	Off	Off	Off	Off	Off	Off	Off	Off	Off	
Heating System, °C																								
Mon - Fri	18	18	18	18	18	20	22	22	22	22	22	22	22	22	22	22	22	22	22	22	18	18	18	18
Sat	18	18	18	18	18	18	18	18	18	18	18	18	18	18	18	18	18	18	18	18	18	18	18	18
Sun	18	18	18	18	18	18	18	18	18	18	18	18	18	18	18	18	18	18	18	18	18	18	18	18
Service Water Heating System, fraction of load																								
Mon - Fri	0.05	0.05	0.05	0.05	0.05	0.05	0.1	0.5	0.5	0.9	0.9	0.9	0.9	0.9	0.9	0.9	0.7	0.5	0.3	0.2	0.2	0.2	0.05	0.05
Sat	0.05	0.05	0.05	0.05	0.05	0.05	0.05	0.05	0.05	0.05	0.05	0.05	0.05	0.05	0.05	0.05	0.05	0.05	0.05	0.05	0.05	0.05	0.05	0.05
Sun	0.05	0.05	0.05	0.05	0.05	0.05	0.05	0.05	0.05	0.05	0.05	0.05	0.05	0.05	0.05	0.05	0.05	0.05	0.05	0.05	0.05	0.05	0.05	0.05

© His Majesty the King in Right of Canada, as represented by the National Research Council of Canada, 2025 © Sa Majesté le Roi du chef du Canada, représenté par le Conseil national de recherches du Canada, 2025

**Table A-8.4.3.2.(1)-B
Operating Schedule B**

Day	Time of Day																							
	1a	2a	3a	4a	5a	6a	7a	8a	9a	10a	11a	12	1p	2p	3p	4p	5p	6p	7p	8p	9p	10p	11p	12
Occupants, fraction occupied																								
Mon - Fri	0.1	0	0	0	0	0	0	0	0.1	0.2	0.5	0.9	0.8	0.5	0.2	0.2	0.3	0.6	0.9	0.9	0.9	0.6	0.4	0.3
Sat	0.3	0	0	0	0	0	0	0.1	0.2	0.5	0.9	0.8	0.5	0.2	0.2	0.3	0.6	0.9	0.9	0.9	0.6	0.6	0.5	
Sun	0.3	0	0	0	0	0	0	0	0.1	0.4	0.5	0.5	0.4	0.2	0.2	0.2	0.5	0.7	0.7	0.5	0.3	0.1	0.1	
Lighting, fraction "ON"																								
Mon - Fri	0.5	0.1	0.1	0.1	0.1	0.1	0.1	0.1	0.5	0.7	0.9	0.9	0.9	0.9	0.9	0.9	0.9	0.9	0.9	0.9	0.9	0.9	0.9	
Sat	0.5	0.1	0.1	0.1	0.1	0.1	0.1	0.1	0.5	0.7	0.9	0.9	0.9	0.9	0.9	0.9	0.9	0.9	0.9	0.9	0.9	0.9	0.9	
Sun	0.5	0.1	0.1	0.1	0.1	0.1	0.1	0.1	0.5	0.9	0.9	0.9	0.9	0.9	0.9	0.9	0.9	0.9	0.9	0.9	0.9	0.9	0.5	
Receptacle Equipment, fraction of load																								
Mon - Fri	0.5	0.1	0.1	0.1	0.1	0.1	0.1	0.1	0.5	0.7	0.9	0.9	0.9	0.9	0.9	0.9	0.9	0.9	0.9	0.9	0.9	0.9	0.9	
Sat	0.5	0.1	0.1	0.1	0.1	0.1	0.1	0.1	0.5	0.7	0.9	0.9	0.9	0.9	0.9	0.9	0.9	0.9	0.9	0.9	0.9	0.9	0.9	
Sun	0.5	0.1	0.1	0.1	0.1	0.1	0.1	0.1	0.5	0.9	0.9	0.9	0.9	0.9	0.9	0.9	0.9	0.9	0.9	0.9	0.9	0.9	0.5	
Fans																								
Mon - Fri	On	Off	Off	Off	Off	Off	Off	On	On	On	On	On	On	On	On	On	On	On	On	On	On	On	On	
Sat	On	Off	Off	Off	Off	Off	Off	On	On	On	On	On	On	On	On	On	On	On	On	On	On	On	On	
Sun	On	Off	Off	Off	Off	Off	Off	On	On	On	On	On	On	On	On	On	On	On	On	On	On	Off	Off	
Cooling System, °C																								
Mon - Fri	Off	Off	Off	Off	Off	Off	Off	24	24	24	24	24	24	24	24	24	24	24	24	24	24	24	24	
Sat	Off	Off	Off	Off	Off	Off	Off	24	24	24	24	24	24	24	24	24	24	24	24	24	24	24	24	
Sun	Off	Off	Off	Off	Off	Off	Off	Off	24	24	24	24	24	24	24	24	24	24	24	24	24	24	Off	
Heating System, °C																								
Mon - Fri	22	18	18	18	18	18	18	20	22	22	22	22	22	22	22	22	22	22	22	22	22	22	22	
Sat	22	18	18	18	18	18	18	20	22	22	22	22	22	22	22	22	22	22	22	22	22	22	22	
Sun	22	18	18	18	18	18	18	18	20	22	22	22	22	22	22	22	22	22	22	22	22	22	18	
Service Water Heating System, fraction of load																								
Mon - Fri	0.5	0.05	0.05	0.05	0.05	0.05	0.05	0.05	0.7	0.7	0.4	0.5	0.6	0.6	0.4	0.3	0.3	0.4	0.5	0.8	0.8	0.9	0.9	
Sat	0.6	0.05	0.05	0.05	0.05	0.05	0.05	0.05	0.7	0.7	0.4	0.5	0.6	0.6	0.4	0.3	0.3	0.4	0.5	0.8	0.8	0.9	0.9	
Sun	0.6	0.05	0.05	0.05	0.05	0.05	0.05	0.05	0.7	0.7	0.4	0.5	0.6	0.6	0.4	0.3	0.3	0.4	0.5	0.8	0.8	0.5	0.5	

© His Majesty the King in Right of Canada, as represented by the National Research Council of Canada, 2025 © Sa Majesté le Roi du chef du Canada, représenté par le Conseil national de recherches du Canada, 2025

Table A-8.4.3.2.(1)-C
Operating Schedule C

Day	Time of Day																							
	1a	2a	3a	4a	5a	6a	7a	8a	9a	10a	11a	12	1p	2p	3p	4p	5p	6p	7p	8p	9p	10p	11p	12
Occupants, fraction occupied																								
Mon - Fri	0	0	0	0	0	0	0	0.1	0.2	0.5	0.5	0.7	0.7	0.7	0.7	0.8	0.7	0.5	0.3	0.3	0	0	0	0
Sat	0	0	0	0	0	0	0	0.1	0.2	0.5	0.6	0.8	0.9	0.9	0.9	0.8	0.7	0.5	0.2	0.2	0	0	0	0
Sun	0	0	0	0	0	0	0	0.1	0.2	0.5	0.6	0.8	0.9	0.9	0.9	0.8	0.7	0.5	0	0	0	0	0	0
Lighting, fraction "ON"																								
Mon - Fri	0.05	0.05	0.05	0.05	0.05	0.05	0.05	0.5	0.9	0.9	0.9	0.9	0.9	0.9	0.9	0.9	0.9	0.9	0.6	0.5	0.05	0.05	0.05	0.05
Sat	0.05	0.05	0.05	0.05	0.05	0.05	0.05	0.5	0.9	0.9	0.9	0.9	0.9	0.9	0.9	0.9	0.9	0.9	0.6	0.5	0.05	0.05	0.05	0.05
Sun	0.05	0.05	0.05	0.05	0.05	0.05	0.05	0.5	0.9	0.9	0.9	0.9	0.9	0.9	0.9	0.9	0.9	0.9	0.05	0.05	0.05	0.05	0.05	0.05
Receptacle Equipment, fraction of load																								
Mon - Fri	0.05	0.05	0.05	0.05	0.05	0.05	0.05	0.5	0.9	0.9	0.9	0.9	0.9	0.9	0.9	0.9	0.9	0.9	0.6	0.5	0.05	0.05	0.05	0.05
Sat	0.05	0.05	0.05	0.05	0.05	0.05	0.05	0.5	0.9	0.9	0.9	0.9	0.9	0.9	0.9	0.9	0.9	0.9	0.6	0.5	0.05	0.05	0.05	0.05
Sun	0.05	0.05	0.05	0.05	0.05	0.05	0.05	0.5	0.9	0.9	0.9	0.9	0.9	0.9	0.9	0.9	0.9	0.9	0.05	0.05	0.05	0.05	0.05	0.05
Fans																								
Mon - Fri	Off	Off	Off	Off	Off	Off	On	On	On	On	On	On	On	On	On	On	On	On	On	On	Off	Off	Off	Off
Sat	Off	Off	Off	Off	Off	Off	On	On	On	On	On	On	On	On	On	On	On	On	On	On	Off	Off	Off	Off
Sun	Off	Off	Off	Off	Off	Off	On	On	On	On	On	On	On	On	On	On	On	On	Off	Off	Off	Off	Off	Off
Cooling System, °C																								
Mon - Fri	Off	Off	Off	Off	Off	Off	24	24	24	24	24	24	24	24	24	24	24	24	24	24	Off	Off	Off	Off
Sat	Off	Off	Off	Off	Off	Off	24	24	24	24	24	24	24	24	24	24	24	24	24	24	Off	Off	Off	Off
Sun	Off	Off	Off	Off	Off	Off	24	24	24	24	24	24	24	24	24	24	24	24	Off	Off	Off	Off	Off	Off
Heating System, °C																								
Mon - Fri	18	18	18	18	18	18	20	22	22	22	22	22	22	22	22	22	22	22	22	22	18	18	18	18
Sat	18	18	18	18	18	18	20	22	22	22	22	22	22	22	22	22	22	22	22	22	18	18	18	18
Sun	18	18	18	18	18	18	18	18	20	22	22	22	22	22	22	22	22	22	18	18	18	18	18	18
Service Water Heating System, fraction of load																								
Mon - Fri	0.05	0.05	0.05	0.05	0.05	0.05	0.05	0.1	0.2	0.3	0.4	0.8	0.8	0.8	0.8	0.6	0.4	0.3	0.2	0.2	0.05	0.05	0.05	0.05
Sat	0.05	0.05	0.05	0.05	0.05	0.05	0.05	0.1	0.2	0.3	0.5	0.9	0.9	0.9	0.9	0.7	0.5	0.3	0.2	0.2	0.05	0.05	0.05	0.05
Sun	0.05	0.05	0.05	0.05	0.05	0.05	0.05	0.1	0.2	0.3	0.5	0.9	0.9	0.9	0.9	0.9	0.5	0.3	0.05	0.05	0.05	0.05	0.05	0.05

**Table A-8.4.3.2.(1)-D
Operating Schedule D**

Day	Time of Day																							
	1a	2a	3a	4a	5a	6a	7a	8a	9a	10a	11a	12	1p	2p	3p	4p	5p	6p	7p	8p	9p	10p	11p	12
Occupants, fraction occupied																								
Mon - Fri	0	0	0	0	0	0	0	0.1	0.9	0.9	0.9	0.8	0.8	0.8	0.8	0.5	0.2	0.1	0.3	0.3	0.3	0.1	0	0
Sat	0	0	0	0	0	0	0	0	0	0	0	0	0	0	0	0	0	0	0	0	0	0	0	0
Sun	0	0	0	0	0	0	0	0	0	0	0	0	0	0	0	0	0	0	0	0	0	0	0	0
Lighting, fraction "ON"																								
Mon - Fri	0.05	0.05	0.05	0.05	0.05	0.05	0.05	0.3	0.9	0.9	0.9	0.9	0.9	0.9	0.9	0.7	0.5	0.5	0.7	0.7	0.7	0.3	0.05	0.05
Sat	0.05	0.05	0.05	0.05	0.05	0.05	0.05	0.05	0.05	0.05	0.05	0.05	0.05	0.05	0.05	0.05	0.05	0.05	0.05	0.05	0.05	0.05	0.05	0.05
Sun	0.05	0.05	0.05	0.05	0.05	0.05	0.05	0.05	0.05	0.05	0.05	0.05	0.05	0.05	0.05	0.05	0.05	0.05	0.05	0.05	0.05	0.05	0.05	0.05
Receptacle Equipment, fraction of load																								
Mon - Fri	0.05	0.05	0.05	0.05	0.05	0.05	0.05	0.3	0.9	0.9	0.9	0.9	0.9	0.9	0.9	0.7	0.5	0.5	0.7	0.7	0.7	0.3	0.05	0.05
Sat	0.05	0.05	0.05	0.05	0.05	0.05	0.05	0.05	0.05	0.05	0.05	0.05	0.05	0.05	0.05	0.05	0.05	0.05	0.05	0.05	0.05	0.05	0.05	0.05
Sun	0.05	0.05	0.05	0.05	0.05	0.05	0.05	0.05	0.05	0.05	0.05	0.05	0.05	0.05	0.05	0.05	0.05	0.05	0.05	0.05	0.05	0.05	0.05	0.05
Fans																								
Mon - Fri	Off	Off	Off	Off	Off	Off	On	On	On	On	On	On	On	On	On	On	On	On	On	On	On	Off	Off	
Sat	Off	Off	Off	Off	Off	Off	Off	Off	Off	Off	Off	Off	Off	Off	Off	Off	Off	Off	Off	Off	Off	Off	Off	Off
Sun	Off	Off	Off	Off	Off	Off	Off	Off	Off	Off	Off	Off	Off	Off	Off	Off	Off	Off	Off	Off	Off	Off	Off	Off
Cooling System, °C																								
Mon - Fri	Off	Off	Off	Off	Off	Off	24	24	24	24	24	24	24	24	24	24	24	24	24	24	24	Off	Off	
Sat	Off	Off	Off	Off	Off	Off	Off	Off	Off	Off	Off	Off	Off	Off	Off	Off	Off	Off	Off	Off	Off	Off	Off	
Sun	Off	Off	Off	Off	Off	Off	Off	Off	Off	Off	Off	Off	Off	Off	Off	Off	Off	Off	Off	Off	Off	Off	Off	
Heating System, °C																								
Mon - Fri	18	18	18	18	18	18	20	22	22	22	22	22	22	22	22	22	22	22	22	22	22	18	18	
Sat	18	18	18	18	18	18	18	18	18	18	18	18	18	18	18	18	18	18	18	18	18	18	18	
Sun	18	18	18	18	18	18	18	18	18	18	18	18	18	18	18	18	18	18	18	18	18	18	18	
Service Water Heating System, fraction of load																								
Mon - Fri	0.05	0.05	0.05	0.05	0.05	0.05	0.05	0.5	0.5	0.9	0.9	0.9	0.9	0.9	0.9	0.7	0.3	0.5	0.5	0.5	0.3	0.05	0.05	0.05
Sat	0.05	0.05	0.05	0.05	0.05	0.05	0.05	0.05	0.05	0.05	0.05	0.05	0.05	0.05	0.05	0.05	0.05	0.05	0.05	0.05	0.05	0.05	0.05	0.05
Sun	0.05	0.05	0.05	0.05	0.05	0.05	0.05	0.05	0.05	0.05	0.05	0.05	0.05	0.05	0.05	0.05	0.05	0.05	0.05	0.05	0.05	0.05	0.05	0.05

Table A-8.4.3.2.(1)-E
Operating Schedule E

Day	Time of Day																							
	1a	2a	3a	4a	5a	6a	7a	8a	9a	10a	11a	12	1p	2p	3p	4p	5p	6p	7p	8p	9p	10p	11p	12
Occupants, fraction occupied																								
Mon - Fri	0	0	0	0	0	0	0	0.2	0.7	0.9	0.9	0.9	0.9	0.5	0.9	0.8	0.8	0.2	0	0	0	0	0	0
Sat	0	0	0	0	0	0	0	0	0.2	0.2	0.2	0.2	0.1	0.1	0.1	0.1	0	0	0	0	0	0	0	0
Sun	0	0	0	0	0	0	0	0	0	0	0	0	0	0	0	0	0	0	0	0	0	0	0	0
Lighting, fraction "ON"																								
Mon - Fri	0.05	0.05	0.05	0.05	0.05	0.05	0.05	0.4	0.7	0.9	0.9	0.9	0.9	0.9	0.9	0.9	0.9	0.4	0.05	0.05	0.05	0.05	0.05	0.05
Sat	0.05	0.05	0.05	0.05	0.05	0.05	0.05	0.05	0.5	0.9	0.9	0.9	0.9	0.9	0.7	0.5	0.05	0.05	0.05	0.05	0.05	0.05	0.05	0.05
Sun	0.05	0.05	0.05	0.05	0.05	0.05	0.05	0.05	0.05	0.05	0.05	0.05	0.05	0.05	0.05	0.05	0.05	0.05	0.05	0.05	0.05	0.05	0.05	0.05
Receptacle Equipment, fraction of load																								
Mon - Fri	0.05	0.05	0.05	0.05	0.05	0.05	0.05	0.4	0.7	0.9	0.9	0.9	0.9	0.9	0.9	0.9	0.9	0.4	0.05	0.05	0.05	0.05	0.05	0.05
Sat	0.05	0.05	0.05	0.05	0.05	0.05	0.05	0.05	0.5	0.9	0.9	0.9	0.9	0.9	0.7	0.5	0.05	0.05	0.05	0.05	0.05	0.05	0.05	0.05
Sun	0.05	0.05	0.05	0.05	0.05	0.05	0.05	0.05	0.05	0.05	0.05	0.05	0.05	0.05	0.05	0.05	0.05	0.05	0.05	0.05	0.05	0.05	0.05	0.05
Fans																								
Mon - Fri	Off	Off	Off	Off	Off	Off	On	On	On	On	On	On	On	On	On	On	On	On	Off	Off	Off	Off	Off	Off
Sat	Off	Off	Off	Off	Off	Off	Off	On	On	On	On	On	On	On	On	Off	Off	Off	Off	Off	Off	Off	Off	Off
Sun	Off	Off	Off	Off	Off	Off	Off	Off	Off	Off	Off	Off	Off	Off	Off	Off	Off	Off	Off	Off	Off	Off	Off	Off
Cooling System, °C																								
Mon - Fri	Off	Off	Off	Off	Off	Off	24	24	24	24	24	24	24	24	24	24	24	24	Off	Off	Off	Off	Off	Off
Sat	Off	Off	Off	Off	Off	Off	Off	24	24	24	24	24	24	24	24	24	Off	Off	Off	Off	Off	Off	Off	Off
Sun	Off	Off	Off	Off	Off	Off	Off	Off	Off	Off	Off	Off	Off	Off	Off	Off	Off	Off	Off	Off	Off	Off	Off	Off
Heating System, °C																								
Mon - Fri	18	18	18	18	18	18	20	22	22	22	22	22	22	22	22	22	22	22	18	18	18	18	18	18
Sat	18	18	18	18	18	18	18	20	22	22	22	22	22	22	22	22	18	18	18	18	18	18	18	18
Sun	18	18	18	18	18	18	18	18	18	18	18	18	18	18	18	18	18	18	18	18	18	18	18	18
Service Water Heating System, fraction of load																								
Mon - Fri	0.05	0.05	0.05	0.05	0.05	0.05	0.05	0.1	0.4	0.5	0.5	0.7	0.9	0.8	0.7	0.8	0.3	0.05	0.05	0.05	0.05	0.05	0.05	0.05
Sat	0.05	0.05	0.05	0.05	0.05	0.05	0.05	0.05	0.05	0.2	0.2	0.4	0.2	0.2	0.2	0.2	0.05	0.05	0.05	0.05	0.05	0.05	0.05	0.05
Sun	0.05	0.05	0.05	0.05	0.05	0.05	0.05	0.05	0.05	0.05	0.05	0.05	0.05	0.05	0.05	0.05	0.05	0.05	0.05	0.05	0.05	0.05	0.05	0.05

© His Majesty the King in Right of Canada, as represented by the National Research Council of Canada, 2025 © Sa Majesté le Roi du chef du Canada, représenté par le Conseil national de recherches du Canada, 2025

**Table A-8.4.3.2.(1)-F
Operating Schedule F**

Day	Time of Day																							
	1a	2a	3a	4a	5a	6a	7a	8a	9a	10a	11a	12	1p	2p	3p	4p	5p	6p	7p	8p	9p	10p	11p	12
Occupants, fraction occupied																								
Mon - Fri	0.63	0.63	0.63	0.63	0.63	0.63	0.49	0.28	0.28	0.14	0.14	0.14	0.14	0.14	0.14	0.21	0.35	0.35	0.35	0.49	0.49	0.56	0.63	0.63
Sat	0.63	0.63	0.63	0.63	0.63	0.63	0.49	0.28	0.28	0.14	0.14	0.14	0.14	0.14	0.14	0.21	0.35	0.35	0.35	0.49	0.49	0.56	0.63	0.63
Sun	0.63	0.63	0.63	0.63	0.63	0.63	0.49	0.28	0.28	0.14	0.14	0.14	0.14	0.14	0.14	0.21	0.35	0.35	0.35	0.49	0.49	0.56	0.63	0.63
Lighting, fraction "ON"																								
Mon - Fri	0.14	0.14	0.07	0.07	0.07	0.14	0.28	0.35	0.28	0.28	0.21	0.14	0.14	0.14	0.14	0.14	0.14	0.14	0.42	0.56	0.63	0.56	0.42	0.21
Sat	0.14	0.14	0.07	0.07	0.07	0.14	0.28	0.35	0.28	0.28	0.21	0.14	0.14	0.14	0.14	0.14	0.14	0.14	0.42	0.56	0.63	0.56	0.42	0.21
Sun	0.14	0.14	0.07	0.07	0.07	0.14	0.28	0.35	0.28	0.28	0.21	0.14	0.14	0.14	0.14	0.14	0.14	0.14	0.42	0.56	0.63	0.56	0.42	0.21
Receptacle Equipment, fraction of load																								
Mon - Fri	0.14	0.14	0.07	0.07	0.07	0.14	0.28	0.35	0.28	0.28	0.21	0.14	0.14	0.14	0.14	0.14	0.14	0.14	0.42	0.56	0.63	0.56	0.42	0.21
Sat	0.14	0.14	0.07	0.07	0.07	0.14	0.28	0.35	0.28	0.28	0.21	0.14	0.14	0.14	0.14	0.14	0.14	0.14	0.42	0.56	0.63	0.56	0.42	0.21
Sun	0.14	0.14	0.07	0.07	0.07	0.14	0.28	0.35	0.28	0.28	0.21	0.14	0.14	0.14	0.14	0.14	0.14	0.14	0.42	0.56	0.63	0.56	0.42	0.21
Fans																								
Mon - Fri	On	On	On	On	On	On	On	On	On	On	On	On	On	On	On	On	On	On	On	On	On	On	On	On
Sat	On	On	On	On	On	On	On	On	On	On	On	On	On	On	On	On	On	On	On	On	On	On	On	On
Sun	On	On	On	On	On	On	On	On	On	On	On	On	On	On	On	On	On	On	On	On	On	On	On	On
Cooling System, °C																								
Mon - Fri	24	24	24	24	24	24	24	24	24	24	24	24	24	24	24	24	24	24	24	24	24	24	24	24
Sat	24	24	24	24	24	24	24	24	24	24	24	24	24	24	24	24	24	24	24	24	24	24	24	24
Sun	24	24	24	24	24	24	24	24	24	24	24	24	24	24	24	24	24	24	24	24	24	24	24	24
Heating System, °C																								
Mon - Fri	18	18	18	18	18	18	20	22	22	22	22	22	22	22	22	22	22	22	22	22	22	22	22	22
Sat	18	18	18	18	18	18	20	22	22	22	22	22	22	22	22	22	22	22	22	22	22	22	22	22
Sun	18	18	18	18	18	18	20	22	22	22	22	22	22	22	22	22	22	22	22	22	22	22	22	22
Service Water Heating System, fraction of load																								
Mon - Fri	0.21	0.14	0.07	0.07	0.14	0.28	0.42	0.63	0.49	0.35	0.35	0.28	0.35	0.28	0.21	0.21	0.21	0.21	0.35	0.49	0.49	0.49	0.49	0.35
Sat	0.21	0.14	0.07	0.07	0.14	0.28	0.42	0.63	0.49	0.35	0.35	0.28	0.35	0.28	0.21	0.21	0.21	0.21	0.35	0.49	0.49	0.49	0.49	0.35
Sun	0.21	0.14	0.07	0.07	0.14	0.28	0.42	0.63	0.49	0.35	0.35	0.28	0.35	0.28	0.21	0.21	0.21	0.21	0.35	0.49	0.49	0.49	0.49	0.35

© His Majesty the King in Right of Canada, as represented by the National Research Council of Canada, 2025 © Sa Majesté le Roi du chef du Canada, représenté par le Conseil national de recherches du Canada, 2025

Table A-8.4.3.2.(1)-G
Operating Schedule G

Day	Times of Day																							
	1a	2a	3a	4a	5a	6a	7a	8a	9a	10a	11a	12	1p	2p	3p	4p	5p	6p	7p	8p	9p	10p	11p	12
Occupants, fraction occupied																								
Mon - Fri	0.9	0.9	0.9	0.9	0.9	0.9	0.7	0.4	0.3	0.3	0.3	0.3	0.3	0.3	0.3	0.3	0.5	0.9	0.9	0.9	0.9	0.9	0.9	0.9
Sat	0.9	0.9	0.9	0.9	0.9	0.9	0.7	0.5	0.5	0.5	0.5	0.5	0.5	0.5	0.5	0.5	0.7	0.9	0.9	0.9	0.9	0.9	0.9	0.9
Sun	0.9	0.9	0.9	0.9	0.9	0.9	0.7	0.5	0.5	0.5	0.5	0.5	0.5	0.5	0.5	0.5	0.7	0.9	0.9	0.9	0.9	0.9	0.9	0.9
Lighting, fraction "ON"																								
Mon - Fri	0	0	0	0	0	0.2	0.5	0.5	0	0	0	0	0	0	0	0	0	0	0.9	0.9	0.9	0.8	0.6	0.3
Sat	0	0	0	0	0	0.2	0.5	0.5	0	0	0	0	0	0	0	0	0	0	0.9	0.9	0.9	0.8	0.6	0.3
Sun	0	0	0	0	0	0.2	0.5	0.5	0	0	0	0	0	0	0	0	0	0	0.9	0.9	0.9	0.8	0.6	0.3
Receptacle Equipment, fraction of load																								
Mon - Fri	0.2	0.2	0.2	0.2	0.2	0.2	0.8	0.8	0.4	0.4	0.4	0.4	0.4	0.4	0.4	0.5	0.2	0.9	0.9	0.7	0.5	0.5	0.5	0.3
Sat	0.2	0.2	0.2	0.2	0.2	0.2	0.8	0.8	0.4	0.4	0.4	0.4	0.4	0.4	0.4	0.5	0.2	0.9	0.9	0.7	0.5	0.5	0.5	0.3
Sun	0.2	0.2	0.2	0.2	0.2	0.2	0.8	0.8	0.4	0.4	0.4	0.4	0.4	0.4	0.4	0.5	0.2	0.9	0.9	0.7	0.5	0.5	0.5	0.3
Fans																								
Mon - Fri	On	On	On	On	On	On	On	On	On	On	On	On	On	On	On	On	On	On	On	On	On	On	On	On
Sat	On	On	On	On	On	On	On	On	On	On	On	On	On	On	On	On	On	On	On	On	On	On	On	On
Sun	On	On	On	On	On	On	On	On	On	On	On	On	On	On	On	On	On	On	On	On	On	On	On	On
Cooling System, °C																								
Mon - Fri	24	24	24	24	24	24	24	24	24	24	24	24	24	24	24	24	24	24	24	24	24	24	24	24
Sat	24	24	24	24	24	24	24	24	24	24	24	24	24	24	24	24	24	24	24	24	24	24	24	24
Sun	24	24	24	24	24	24	24	24	24	24	24	24	24	24	24	24	24	24	24	24	24	24	24	24
Heating System, °C																								
Mon - Fri	18	18	18	18	18	18	20	22	22	22	22	22	22	22	22	22	22	22	22	22	22	22	22	22
Sat	18	18	18	18	18	18	20	22	22	22	22	22	22	22	22	22	22	22	22	22	22	22	22	22
Sun	18	18	18	18	18	18	20	22	22	22	22	22	22	22	22	22	22	22	22	22	22	22	22	22
Service Water Heating System, fraction of load																								
Mon - Fri	0.05	0.05	0.05	0.05	0.05	0.2	0.8	0.7	0.5	0.4	0.2	0.2	0.2	0.3	0.5	0.5	0.7	0.7	0.4	0.4	0.2	0.2	0.1	0.1
Sat	0.05	0.05	0.05	0.05	0.05	0.05	0.2	0.5	0.5	0.5	0.3	0.3	0.3	0.3	0.7	0.9	0.7	0.7	0.6	0.5	0.4	0.3	0.2	0.1
Sun	0.05	0.05	0.05	0.05	0.05	0.05	0.05	0.2	0.3	0.3	0.2	0.2	0.3	0.4	0.5	0.6	0.7	0.4	0.3	0.2	0.2	0.2	0.2	0.1

**Table A-8.4.3.2.(1)-H
Operating Schedule H**

Day	Time of Day																							
	1a	2a	3a	4a	5a	6a	7a	8a	9a	10a	11a	12	1p	2p	3p	4p	5p	6p	7p	8p	9p	10p	11p	12
Occupants, fraction occupied																								
Mon - Fri	0.9	0.9	0.9	0.9	0.9	0.9	0.9	0.9	0.9	0.9	0.9	0.9	0.9	0.9	0.9	0.9	0.9	0.9	0.9	0.9	0.9	0.9	0.9	0.9
Sat	0.9	0.9	0.9	0.9	0.9	0.9	0.9	0.9	0.9	0.9	0.9	0.9	0.9	0.9	0.9	0.9	0.9	0.9	0.9	0.9	0.9	0.9	0.9	0.9
Sun	0.9	0.9	0.9	0.9	0.9	0.9	0.9	0.9	0.9	0.9	0.9	0.9	0.9	0.9	0.9	0.9	0.9	0.9	0.9	0.9	0.9	0.9	0.9	0.9
Lighting, fraction "ON"																								
Mon - Fri	0.9	0.9	0.9	0.9	0.9	0.9	0.9	0.9	0.9	0.9	0.9	0.9	0.9	0.9	0.9	0.9	0.9	0.9	0.9	0.9	0.9	0.9	0.9	0.9
Sat	0.9	0.9	0.9	0.9	0.9	0.9	0.9	0.9	0.9	0.9	0.9	0.9	0.9	0.9	0.9	0.9	0.9	0.9	0.9	0.9	0.9	0.9	0.9	0.9
Sun	0.9	0.9	0.9	0.9	0.9	0.9	0.9	0.9	0.9	0.9	0.9	0.9	0.9	0.9	0.9	0.9	0.9	0.9	0.9	0.9	0.9	0.9	0.9	0.9
Receptacle Equipment, fraction of load																								
Mon - Fri	0.9	0.9	0.9	0.9	0.9	0.9	0.9	0.9	0.9	0.9	0.9	0.9	0.9	0.9	0.9	0.9	0.9	0.9	0.9	0.9	0.9	0.9	0.9	0.9
Sat	0.9	0.9	0.9	0.9	0.9	0.9	0.9	0.9	0.9	0.9	0.9	0.9	0.9	0.9	0.9	0.9	0.9	0.9	0.9	0.9	0.9	0.9	0.9	0.9
Sun	0.9	0.9	0.9	0.9	0.9	0.9	0.9	0.9	0.9	0.9	0.9	0.9	0.9	0.9	0.9	0.9	0.9	0.9	0.9	0.9	0.9	0.9	0.9	0.9
Fans																								
Mon - Fri	On	On	On	On	On	On	On	On	On	On	On	On	On	On	On	On	On	On	On	On	On	On	On	On
Sat	On	On	On	On	On	On	On	On	On	On	On	On	On	On	On	On	On	On	On	On	On	On	On	On
Sun	On	On	On	On	On	On	On	On	On	On	On	On	On	On	On	On	On	On	On	On	On	On	On	On
Cooling System, °C																								
Mon - Fri	24	24	24	24	24	24	24	24	24	24	24	24	24	24	24	24	24	24	24	24	24	24	24	24
Sat	24	24	24	24	24	24	24	24	24	24	24	24	24	24	24	24	24	24	24	24	24	24	24	24
Sun	24	24	24	24	24	24	24	24	24	24	24	24	24	24	24	24	24	24	24	24	24	24	24	24
Heating System, °C																								
Mon - Fri	18	18	18	18	18	18	20	22	22	22	22	22	22	22	22	22	22	22	22	22	22	22	22	22
Sat	18	18	18	18	18	18	20	22	22	22	22	22	22	22	22	22	22	22	22	22	22	22	22	22
Sun	18	18	18	18	18	18	20	22	22	22	22	22	22	22	22	22	22	22	22	22	22	22	22	22
Service Water Heating System, fraction of load																								
Mon - Fri	0.9	0.9	0.9	0.9	0.9	0.9	0.9	0.9	0.9	0.9	0.9	0.9	0.9	0.9	0.9	0.9	0.9	0.9	0.9	0.9	0.9	0.9	0.9	0.9
Sat	0.9	0.9	0.9	0.9	0.9	0.9	0.9	0.9	0.9	0.9	0.9	0.9	0.9	0.9	0.9	0.9	0.9	0.9	0.9	0.9	0.9	0.9	0.9	0.9
Sun	0.9	0.9	0.9	0.9	0.9	0.9	0.9	0.9	0.9	0.9	0.9	0.9	0.9	0.9	0.9	0.9	0.9	0.9	0.9	0.9	0.9	0.9	0.9	0.9

© His Majesty the King in Right of Canada, as represented by the National Research Council of Canada, 2025 © Sa Majesté le Roi du chef du Canada, représenté par le Conseil national de recherches du Canada, 2025

Table A-8.4.3.2.(1)-I
Operating Schedule I

Day	Time of Day																							
	1a	2a	3a	4a	5a	6a	7a	8a	9a	10a	11a	12	1p	2p	3p	4p	5p	6p	7p	8p	9p	10p	11p	12
Occupants, fraction occupied																								
Mon - Fri	0	0	0	0	0	0	0	0	0	0	0	0	0	0	0.1	0.1	0.1	0.4	0.8	0.8	0.8	0.6	0.4	0.1
Sat	0	0	0	0	0	0	0	0	0	0.1	0.1	0.1	0.4	0.6	0.8	0.6	0.4	0.2	0.4	0.8	0.8	0.6	0.4	0.1
Sun	0	0	0	0	0	0	0	0.2	0.4	0.8	0.8	0.4	0.2	0	0	0	0	0	0	0	0	0	0	0
Lighting, fraction "ON"																								
Mon - Fri	0.05	0.05	0.05	0.05	0.05	0.05	0.05	0.05	0.05	0.05	0.05	0.05	0.05	0.05	0.5	0.5	0.5	0.8	0.9	0.9	0.9	0.9	0.9	0.5
Sat	0.05	0.05	0.05	0.05	0.05	0.05	0.05	0.05	0.05	0.5	0.5	0.5	0.8	0.9	0.9	0.9	0.8	0.6	0.8	0.9	0.9	0.9	0.9	0.5
Sun	0.05	0.05	0.05	0.05	0.05	0.05	0.05	0.5	0.9	0.9	0.9	0.9	0.5	0.05	0.05	0.05	0.05	0.05	0.05	0.05	0.05	0.05	0.05	0.05
Receptacle Equipment, fraction of load																								
Mon - Fri	0.1	0.1	0.1	0.1	0.1	0.1	0.1	0.1	0.1	0.1	0.1	0.1	0.1	0.1	0.2	0.2	0.2	0.8	0.8	0.8	0.8	0.8	0.8	0.1
Sat	0.1	0.1	0.1	0.1	0.1	0.1	0.1	0.1	0.1	0.2	0.2	0.2	0.8	0.8	0.8	0.8	0.8	0.8	0.8	0.8	0.8	0.8	0.8	0.1
Sun	0.1	0.1	0.1	0.1	0.1	0.1	0.1	0.8	0.8	0.8	0.8	0.8	0.2	0.1	0.1	0.1	0.1	0.1	0.1	0.1	0.1	0.1	0.1	0.1
Fans																								
Mon - Fri	Off	Off	Off	Off	Off	Off	Off	Off	Off	Off	Off	Off	Off	On	On	On	On	On	On	On	On	On	On	On
Sat	Off	Off	Off	Off	Off	Off	Off	Off	Off	On	On	On	On	On	On	On	On	On	On	On	On	On	On	On
Sun	Off	Off	Off	Off	Off	Off	On	On	On	On	On	On	Off	Off	Off	Off	Off	Off	Off	Off	Off	Off	Off	Off
Cooling System, °C																								
Mon - Fri	Off	Off	Off	Off	Off	Off	Off	Off	Off	Off	Off	Off	24	24	24	24	24	24	24	24	24	24	24	Off
Sat	Off	Off	Off	Off	Off	Off	Off	Off	Off	24	24	24	24	24	24	24	24	24	24	24	24	24	24	Off
Sun	Off	Off	Off	Off	Off	Off	24	24	24	24	24	24	24	Off	Off	Off	Off	Off	Off	Off	Off	Off	Off	Off
Heating System, °C																								
Mon - Fri	18	18	18	18	18	18	18	18	18	18	18	18	18	20	22	22	22	22	22	22	22	22	22	18
Sat	18	18	18	18	18	18	18	18	18	20	22	22	22	22	22	22	22	22	22	22	22	22	22	18
Sun	18	18	18	18	18	18	20	22	22	22	22	22	22	18	18	18	18	18	18	18	18	18	18	18
Service Water Heating System, fraction of load																								
Mon - Fri	0.05	0.05	0.05	0.05	0.05	0.05	0.05	0.05	0.05	0.05	0.05	0.05	0.05	0.05	0.2	0.2	0.2	0.4	0.9	0.9	0.9	0.8	0.6	0.2
Sat	0.05	0.05	0.05	0.05	0.05	0.05	0.05	0.05	0.05	0.2	0.2	0.2	0.4	0.8	0.9	0.8	0.6	0.4	0.4	0.9	0.9	0.8	0.6	0.2
Sun	0.05	0.05	0.05	0.05	0.05	0.05	0.05	0.1	0.2	0.4	0.4	0.2	0.1	0.05	0.05	0.05	0.05	0.05	0.05	0.05	0.05	0.05	0.05	0.05

**Table A-8.4.3.2.(1)-J
Operating Schedule J**

Day	Time of Day																							
	1a	2a	3a	4a	5a	6a	7a	8a	9a	10a	11a	12	1p	2p	3p	4p	5p	6p	7p	8p	9p	10p	11p	12
Occupants, fraction occupied																								
Mon - Fri	0.9	0.9	0.9	0.9	0.9	0.9	0.7	0.6	0.6	0.7	0.7	0.6	0.6	0.7	0.7	0.7	0.6	0.6	0.6	0.7	0.7	0.8	0.9	0.9
Sat	0.9	0.9	0.9	0.9	0.9	0.9	0.7	0.6	0.6	0.7	0.7	0.6	0.6	0.7	0.7	0.7	0.6	0.6	0.6	0.7	0.7	0.8	0.9	0.9
Sun	0.9	0.9	0.9	0.9	0.9	0.9	0.7	0.6	0.6	0.7	0.7	0.6	0.6	0.7	0.7	0.7	0.6	0.6	0.6	0.7	0.7	0.8	0.9	0.9
Lighting, fraction "ON"																								
Mon - Fri	0.1	0.1	0.1	0.1	0.3	0.5	0.7	0.7	0.7	0.7	0.6	0.5	0.5	0.5	0.5	0.5	0.5	0.6	0.7	0.7	0.7	0.7	0.3	0.1
Sat	0.1	0.1	0.1	0.1	0.3	0.5	0.7	0.7	0.7	0.7	0.6	0.5	0.5	0.5	0.5	0.5	0.5	0.6	0.7	0.7	0.7	0.7	0.3	0.1
Sun	0.1	0.1	0.1	0.1	0.3	0.5	0.7	0.7	0.7	0.7	0.6	0.5	0.5	0.5	0.5	0.5	0.5	0.6	0.7	0.7	0.7	0.7	0.3	0.1
Receptacle Equipment, fraction of load																								
Mon - Fri	0.1	0.1	0.1	0.1	0.2	0.3	0.4	0.6	0.6	0.5	0.5	0.4	0.4	0.5	0.5	0.4	0.4	0.5	0.6	0.7	0.7	0.5	0.3	0.1
Sat	0.1	0.1	0.1	0.1	0.2	0.3	0.4	0.6	0.6	0.5	0.5	0.4	0.4	0.5	0.5	0.4	0.4	0.5	0.6	0.7	0.7	0.5	0.3	0.1
Sun	0.1	0.1	0.1	0.1	0.2	0.3	0.4	0.6	0.6	0.5	0.5	0.4	0.4	0.5	0.5	0.4	0.4	0.5	0.6	0.7	0.7	0.5	0.3	0.1
Fans																								
Mon - Fri	On	On	On	On	On	On	On	On	On	On	On	On	On	On	On	On	On	On	On	On	On	On	On	On
Sat	On	On	On	On	On	On	On	On	On	On	On	On	On	On	On	On	On	On	On	On	On	On	On	On
Sun	On	On	On	On	On	On	On	On	On	On	On	On	On	On	On	On	On	On	On	On	On	On	On	On
Cooling System, °C																								
Mon - Fri	24	24	24	24	24	24	24	24	24	24	24	24	24	24	24	24	24	24	24	24	24	24	24	24
Sat	24	24	24	24	24	24	24	24	24	24	24	24	24	24	24	24	24	24	24	24	24	24	24	24
Sun	24	24	24	24	24	24	24	24	24	24	24	24	24	24	24	24	24	24	24	24	24	24	24	24
Heating System, °C																								
Mon - Fri	22	22	22	22	22	22	22	22	22	22	22	22	22	22	22	22	22	22	22	22	22	22	22	22
Sat	22	22	22	22	22	22	22	22	22	22	22	22	22	22	22	22	22	22	22	22	22	22	22	22
Sun	22	22	22	22	22	22	22	22	22	22	22	22	22	22	22	22	22	22	22	22	22	22	22	22
Service Water Heating System, fraction of load																								
Mon - Fri	0.1	0.1	0.1	0.1	0.2	0.4	0.6	0.6	0.6	0.6	0.6	0.6	0.6	0.6	0.6	0.6	0.6	0.6	0.6	0.6	0.3	0.1	0.1	0.1
Sat	0.3	0.2	0.1	0.1	0.2	0.4	0.5	0.8	0.6	0.5	0.5	0.5	0.5	0.5	0.4	0.3	0.3	0.3	0.5	0.7	0.7	0.7	0.7	0.5
Sun	0.3	0.2	0.1	0.1	0.2	0.4	0.4	0.6	0.9	0.7	0.5	0.5	0.5	0.4	0.3	0.3	0.3	0.3	0.4	0.6	0.6	0.6	0.6	0.5

© His Majesty the King in Right of Canada, as represented by the National Research Council of Canada, 2025 © Sa Majesté le Roi du chef du Canada, représenté par le Conseil national de recherches du Canada, 2025

**Table A-8.4.3.2.(1)-K
Operating Schedule K**

Day	Time of Day																							
	1a	2a	3a	4a	5a	6a	7a	8a	9a	10a	11a	12	1p	2p	3p	4p	5p	6p	7p	8p	9p	10p	11p	12
Occupants, fraction occupied																								
Mon - Fri	0	0	0	0	0.1	0.5	0.9	0.6	0.2	0.2	0.2	0.2	0.2	0.2	0.2	0.7	0.9	0.6	0.2	0.1	0.1	0.1	0	0
Sat	0	0	0	0	0.1	0.5	0.9	0.6	0.2	0.2	0.2	0.2	0.2	0.2	0.2	0.7	0.9	0.6	0.2	0.1	0.1	0.1	0	0
Sun	0	0	0	0	0.1	0.5	0.9	0.6	0.2	0.2	0.2	0.2	0.2	0.2	0.2	0.7	0.9	0.6	0.2	0.1	0.1	0.1	0	0
Lighting, fraction "ON"																								
Mon - Fri	0.9	0.9	0.9	0.9	0.9	0.9	0.9	0.9	0.9	0.9	0.9	0.9	0.9	0.9	0.9	0.9	0.9	0.9	0.9	0.9	0.9	0.9	0.9	0.9
Sat	0.9	0.9	0.9	0.9	0.9	0.9	0.9	0.9	0.9	0.9	0.9	0.9	0.9	0.9	0.9	0.9	0.9	0.9	0.9	0.9	0.9	0.9	0.9	0.9
Sun	0.9	0.9	0.9	0.9	0.9	0.9	0.9	0.9	0.9	0.9	0.9	0.9	0.9	0.9	0.9	0.9	0.9	0.9	0.9	0.9	0.9	0.9	0.9	0.9
Receptacle Equipment, fraction of load																								
Mon - Fri	0	0	0	0	0	0	0	0	0	0	0	0	0	0	0	0	0	0	0	0	0	0	0	0
Sat	0	0	0	0	0	0	0	0	0	0	0	0	0	0	0	0	0	0	0	0	0	0	0	0
Sun	0	0	0	0	0	0	0	0	0	0	0	0	0	0	0	0	0	0	0	0	0	0	0	0
Fans																								
Mon - Fri	Off	Off	Off	Off	Off	On	On	On	On	Off	Off	Off	Off	Off	Off	On	On	On	Off	Off	Off	Off	Off	Off
Sat	Off	Off	Off	Off	Off	On	On	On	On	Off	Off	Off	Off	Off	Off	On	On	On	Off	Off	Off	Off	Off	Off
Sun	Off	Off	Off	Off	Off	On	On	On	On	Off	Off	Off	Off	Off	Off	On	On	On	Off	Off	Off	Off	Off	Off
Cooling System, °C																								
Mon - Fri	Off	Off	Off	Off	Off	Off	Off	Off	Off	Off	Off	Off	Off	Off	Off	Off	Off	Off	Off	Off	Off	Off	Off	Off
Sat	Off	Off	Off	Off	Off	Off	Off	Off	Off	Off	Off	Off	Off	Off	Off	Off	Off	Off	Off	Off	Off	Off	Off	Off
Sun	Off	Off	Off	Off	Off	Off	Off	Off	Off	Off	Off	Off	Off	Off	Off	Off	Off	Off	Off	Off	Off	Off	Off	Off
Heating System, °C																								
Mon - Fri	5	5	5	5	5	5	5	5	5	5	5	5	5	5	5	5	5	5	5	5	5	5	5	5
Sat	5	5	5	5	5	5	5	5	5	5	5	5	5	5	5	5	5	5	5	5	5	5	5	5
Sun	5	5	5	5	5	5	5	5	5	5	5	5	5	5	5	5	5	5	5	5	5	5	5	5
Service Water Heating System, fraction of load																								
Mon - Fri	0	0	0	0	0	0	0	0	0	0	0	0	0	0	0	0	0	0	0	0	0	0	0	0
Sat	0	0	0	0	0	0	0	0	0	0	0	0	0	0	0	0	0	0	0	0	0	0	0	0
Sun	0	0	0	0	0	0	0	0	0	0	0	0	0	0	0	0	0	0	0	0	0	0	0	0

A-8.4.3.2.(2) Internal and Service Water Heating Loads and Illuminance

Levels. Tables A-8.4.3.2.(2)-A and A-8.4.3.2.(2)-B contain representative internal and service water heating loads, operating schedules, and illuminance levels to be used as modeling guidance when actual values are not known.

Table A-8.4.3.2.(2)-A
Modeling Guidance for Loads, Operating Schedules and Illuminance Levels by Building Type

Building Type	Occupant Density, m ² /occupant	Peak Receptacle Load, W/m ²	Service Water Heating Load, W/occupant	Operating Schedule from A-8.4.3.2.(1)	Illuminance Levels, lx ⁽¹⁾
Automotive facility	20	5	90	E	400
Convention centre	8	2.5	30	C	300
Courthouse	15	5	60	A	400
Dining					
bar lounge/leisure	10	1	115	B	125
cafeteria/fast food	10	1	115	B	300
family	10	1	115	B	300
Dormitory	30	2.5	500	G	100
Exercise centre	10	1	90	B	350
Fire station	25	2.5	400	F	400
Gymnasium	10	1	90	B	500
Healthcare clinic	20	7.5	90	A	600
Hospital	20	7.5	90	H	350
Hotel/Motel	25	2.5	500	F	150
Library	20	2.5	90	C	500
Long-term care					
dwelling units	25	1.5	500	J	400
other	25	1.5	500	B	400
Manufacturing facility	30	10	90	A	450
Motion picture theatre	8	1	30	C	150
Multi-unit residential building	25	5	500	G	125
Museum	20	2.5	60	C	100
Office	25	7.5	90	A	400
Penitentiary	30	2.5	400	H	250
Performing arts theatre	8	1	30	C	250
Police station	25	7.5	90	H	400
Post office	25	7.5	90	A	400
Religious building	5	1	15	I	250
Retail area	30	2.5	40	C	450
School/university	8	5	60	D	400
Sports arena	10	1	90	B	400
Storage garage	1000	0	0	K	75
Town hall	25	7.5	90	D	400
Transportation facility	15	1	65	H	225
Warehouse	1500	1	300	A	150
Workshop	30	10	90	A	500

Table A-8.4.3.2.(2)-A (Continued)

Notes to Table A-8.4.3.2.(2)-A:

(1) The values are weighted averages that correspond to typical overall illuminance levels recommended for the buildings/space types listed and include both general lighting and task lighting. They are based on recommendations published by the IES.

**Table A-8.4.3.2.(2)-B
Modeling Guidance for Loads, Operating Schedules and Illuminance Levels by Space Type**

Common Space Types					
Space Type	Occupant Density, m ² /occupant	Peak Receptacle Load, W/m ²	Service Water Heating Load, W/occupant	Operating Schedule ⁽¹⁾ from A-8.4.3.2.(1)	Illuminance Levels, lx ⁽²⁾
Atrium (any height)	10	2.5	0	*	250
Audience seating area – permanent					
for auditorium	5	2.5	30	C	100
for convention centre	5	2.5	30	C	350
for gymnasium	5	0	30	B	350
for motion picture theatre	5	2.5	30	C	250
for penitentiary	5	2.5	30	C	250
for performing arts theatre	7.5	2.5	30	C	250
for religious building	5	1	15	I	150
for sports arena	5	0	30	B	150
other	5	1	15	*	100
Banking activity area and offices	25	5	60	A	400
Classroom/Lecture hall/Training room	7.5	5	65	D	400
Computer/Server room	100	200	90	* or H ⁽³⁾	350
Conference/Meeting/Multi-purpose room	5	1	45	C	350
Confinement cell	25	0	325	G	400
Copy/Print room	100	60	90	A	400
Corridor/Transition area	100	0	0	*	150
Courtroom	5	2.5	30	A	400
Dining area					
for bar lounge/leisure dining	10	1	90	B	100
for cafeteria/fast food dining	10	1	120	B	200
for family dining	10	1	120	B	200
for penitentiary	10	1	120	B	200
for space designed to ANSI/IES RP-28 (used primarily by residents)	10	1	120	B	200
other	10	1	120	B	200
Dressing/Fitting room for performing arts theatre	30	2.5	40	C	250
Electrical/Mechanical room	200	1	0	*	350
Emergency vehicle garage	25	2.5	325	H	350
Food preparation area	20	10	120	B	500
Guest room	25	2.5	600	F	200
Laboratory					
for classrooms	20	10	180	D	500
other	20	10	180	A	650
Laundry/Washing area	20	20	60	C	350
Loading dock – interior	500	0	0	H	200

Table A-8.4.3.2.(2)-B (Continued)

Common Space Types					
Space Type	Occupant Density, m ² /occupant	Peak Receptacle Load, W/m ²	Service Water Heating Load, W/occupant	Operating Schedule ⁽¹⁾ from A-8.4.3.2.(1)	Illuminance Levels, lx ⁽²⁾
Lobby					
for elevator	10	1	0	C	200
for hotel	10	2.5	30	H	250
for motion picture theatre	10	1	0	C	150
for performing arts theatre	10	1	0	C	200
for space designed to ANSI/IES RP-28 (used primarily by residents)	10	2.5	30	B	150
other	10	1	0	C	150
Locker room	10	2.5	0	*	100
Lounge/Break room					
for healthcare facility	10	1	60	B	150
other	10	1	60	B	150
Office	20	7.5	90	A	400
Pharmacy area	20	2.5	45	C	400
Sales area	30	2.5	40	C	500
Seating area – general	10	0	65	*	150
Stairway/Stairwell	200	0	0	*	150
Storage garage – interior	1000	0	0	K	75
Storage room					
≥ 5 m ²	100	1	300	*	100
< 5 m ²	100	0	0	*	100
Vehicle maintenance area	20	5	90	E	500
Washroom					
for space designed to ANSI/IES RP-28 (used primarily by residents)	30	1	0	*	150
other	30	1	0	*	150
Workshop	30	10	90	A	500
Building-Specific Space Types					
Space Type	Occupant Density, m ² /occupant	Peak Receptacle Load, W/m ²	Service Water Heating Load, W/occupant	Operating Schedule ⁽¹⁾ from A-8.4.3.2.(1)	Illuminance Levels, lx ⁽²⁾
Convention centre – exhibit space	10	2.5	30	C	500
Dormitory – living quarters	25	2.5	500	G	125
Dwelling units					
general	25	5	500	G	125
long-term	25	2.5	500	J	300
Fire station – sleeping quarters	25	2.5	500	G	150
Gymnasium/Fitness centre					
exercise area	5	1	90	B	350
playing area	5	1.5	90	B	350

Table A-8.4.3.2.(2)-B (Continued)

Building-Specific Space Types					
Space Type	Occupant Density, m²/occupant	Peak Receptacle Load, W/m²	Service Water Heating Load, W/occupant	Operating Schedule⁽¹⁾ from A-8.4.3.2.(1)	Illuminance Levels, lx⁽²⁾
Healthcare facility					
exam/treatment room	20	10	90	C	600
imaging room	20	10	90	H	225
medical supply room	20	1	0	H	400
nursery	20	10	90	H	400
nurses' station	20	2.5	45	H	400
operating room	20	10	300	H	1000
patient room	20	10	90	H	400
physical therapy room	20	10	45	C	350
recovery room	20	10	180	H	250
Library					
reading area	20	1	90	C	500
stacks	20	0	90	C	500
Manufacturing facility					
detailed manufacturing area	30	10	90	A	600
equipment room	30	10	90	A	250
extra high bay area (> 15 m floor-to-ceiling height)	30	10	90	A	400
high bay area (7.5 to 15 m floor-to-ceiling height)	30	10	90	A	400
low bay area (< 7.5 m floor-to-ceiling height)	30	10	90	A	400
Museum					
general exhibition area	5	2.5	60	C	250
restoration room	20	5	50	A	600
Post office – sorting area	20	7.5	90	A	400
Religious building					
fellowship hall	5	1	45	C	250
worship/pulpit/choir area	5	1	15	I	250
Retail facility					
dressing/fitting room	30	2.5	40	C	350
mall concourse	20	1	30	C	400
Space designed to ANSI/IES RP-28					
chapel (used primarily by residents)	10	1	15	I	150
recreation room (used primarily by residents)	20	1	60	B	150
Sports arena – playing area					
class I facility ⁽⁴⁾	5	1.5	90	B	1600
class II facility ⁽⁴⁾	5	1.5	90	B	1000
class III facility ⁽⁴⁾	5	1.5	90	B	800
class IV facility ⁽⁴⁾	5	1.5	90	B	500

Table A-8.4.3.2.(2)-B (Continued)

Building-Specific Space Types					
Space Type	Occupant Density, m ² /occupant	Peak Receptacle Load, W/m ²	Service Water Heating Load, W/occupant	Operating Schedule ⁽¹⁾ from A-8.4.3.2.(1)	Illuminance Levels, lx ⁽²⁾
Transportation facility					
airport concourse	20	0	65	H	150
baggage/carousel area	20	2.5	65	H	250
terminal ticket counter	10	2.5	65	H	250
Warehouse – storage area					
medium to bulky palletized items	100	1	65	A	200
small hand-carried items ⁽⁴⁾	50	1	65	A	300

Notes to Table A-8.4.3.2.(2)-B:

- (1) An asterisk (*) in this column indicates that there is no recommended default schedule for the space type listed. In general, such space types will be simulated using a schedule that is similar to the adjacent spaces served: e.g. a corridor space serving an adjacent office space will be simulated using a schedule that is similar to that of the office space.
- (2) The values are weighted averages that correspond to typical overall illuminance levels recommended for the buildings/space types listed and include both general lighting and task lighting. They are based on recommendations published by the IES.
- (3) A computer/server room that serves a single building or a limited group of users would tend to have operating schedules matching those of that group or building. Computer/server rooms that serve as data centres operating independently of the building in which they are located would tend to operate continuously.
- (4) See Note A-Table 4.2.1.6.

A-8.4.3.3.(2) Interior Shading. Interior shading provided by devices such as blinds is typically not modeled, unless the devices are part of an automated control system.

A-8.4.3.4.(4) Illumination Set-points. See Table A-8.4.3.2.(2)-B for representative illuminance levels to be used as modeling guidance.

A-8.4.3.5. Purchased Energy. Purchased energy is typically defined as thermal energy produced from a source external to the scope of the proposed building assessment. It is used as heating and/or cooling energy in an HVAC or service water heating system—as a heat source and/or sink—that is provided either directly or through a heat exchanger or other equipment.

A-8.4.3.6.(1) Outdoor Air. The basic ventilation rates for the proposed building must be set to the minimum rates required by the applicable standards. If the HVAC system includes demand control ventilation strategies, the basic rates can then be adjusted in the energy model calculations to reflect their operation.

While the Code doesn't restrict modeling of any demand control ventilation strategies implemented in the proposed building, their effectiveness varies significantly from one application to another. As such, only demand control ventilation strategies that are known to reliably generate energy savings should be modeled, and this, in such a way as to avoid overestimating those savings.

A-8.4.3.9. Heat Recovery from Ice Plants. Where the energy model software does not allow for modeling of ice plants, a water-cooled, double-bundle water chiller with a load profile corresponding to the expected loading on the ice plant is adequate for the purposes of Part 8 and allows the modeling of heat recovery using most types of simulation software.

The following documents may be helpful in setting a more detailed model using refrigeration equipment rather than a water chiller and modeling the ice sheet itself and its interaction with adjacent components and spaces:

- Zmeureanu, R., E.M. Zelaya and D. Giguère. (2002). Simulation de la consommation d'énergie d'un aréna à l'aide du logiciel DOE-2.1E. ESIm 2002 Conference, Montreal.
- Ouzzane, M. et al. Cooling Load and Environmental Measurements in a Canadian Indoor Ice Rink. ASHRAE Transactions, Vol. 112, Pt. 2, Paper no. QC-06-008, pp. 538-545, 2006.
- Sunyé, R. et al. ASHRAE Research Report 1289, Develop and Verify Methods For Determining Ice Sheet Cooling Loads, 2007.

- Teysseidou, G., R. Zmeureanu, and D. Giguère. (2009). Thermal Response of the Concrete Slab of an Indoor Ice Rink. ASHRAE HVAC&R Research, Vol. 15, No. 3, May 2009.

Since ice-making for rinks is often associated with resurfacing activities, which require a significant amount of heated service water, the energy models of the proposed and reference buildings should account for this load.

A-8.4.4.2.(1) Modeling of Occupancy Controls. A common modeling practice to take occupancy controls into account is to adjust the operating schedules to reflect their operation. Another option is to adjust the internal loads applied to the thermal block as exemplified in Sentence 8.4.4.2.(3). Whichever option is chosen, the same modeling approach should be applied to both the proposed and reference buildings. Demand control ventilation is an example of a control strategy that would be modeled in the reference building but that may not be modeled in the proposed building.

A-8.4.4.2.(3) Semi-heated Building. A reference building with a set-point of 18°C and thermal characteristics based on the heating degree-days at 18°C is intended to have the same energy performance as a building with a set-point of 15°C and thermal characteristics based on the heating degree-days at 15°C.

A-8.4.4.3.(8) Fenestration Properties. Solar heat gain is an example of a thermal property of fenestration.

A-8.4.4.4.(1) Thermal Mass. The building envelope assemblies should follow the layer structure of the proposed building's assemblies (type and order), but the insulation thickness should be varied to match the U-value of Part 3. See the "ASHRAE Handbook – Fundamentals" for examples of different types of construction.

Examples 1 and 2 present examples of lightweight wood-frame and steel-frame assemblies.

Example 1 – Lightweight Wood-Frame Wall Construction

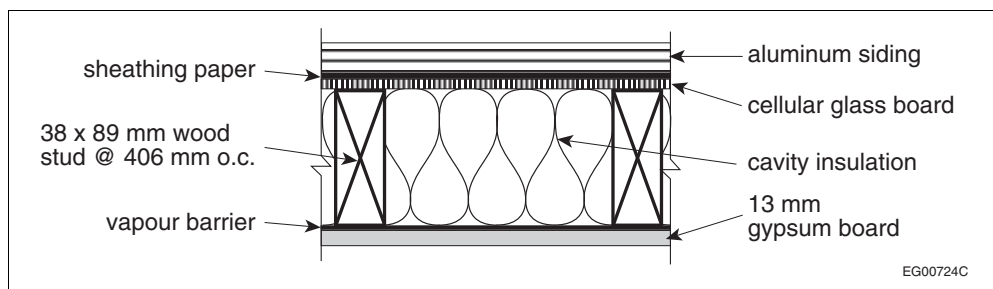

Figure 1-1
11% wood-frame wall construction

Table 1-1
Nominal R-Values of Wall Components in Figure 1-1

Component	Component Thickness, in mm	Nominal R-Value
Outside surface air film	–	0.030
Siding – aluminum or steel with sheathing	10	0.107
Sheathing paper	4	0.02
Insulation – cellular glass board	38	0.753
Insulation – mineral fibre, RSI 2.11 ⁽¹⁾	89	2.110
Polyethylene vapour barrier	2	0
Gypsum sheathing	13	0.081
Inside surface air film	–	0.120

Notes to Table 1-1:

⁽¹⁾ The framing, whose R-value is 0.611, is installed with this component.

The overall weight of the assembly in Figure 1-1 is 40.8 kg/m² and its heat capacity is 45.5 kJ/(m²×°C).

Example 2 – Lightweight Steel-Frame Wall Construction

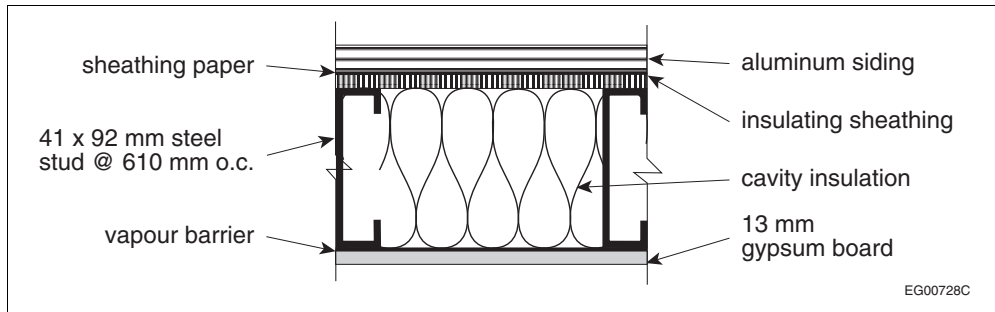

Figure 2-1
37% steel-frame wall construction

Table 2-1
Nominal R-Values of Wall Components in Figure 2-1

Component	Component Thickness, in mm	Nominal R-Value
Outside surface air film	–	0.030
Siding – aluminum or steel with sheathing	10	0.107
Sheathing paper	4	0.02
Insulation – polystyrene, smooth skin	38	1.317
Insulation – mineral fibre, RSI 2.11 ⁽¹⁾	89	2.110
Polyethylene vapour barrier	2	0
Gypsum sheathing	13	0.081
Inside surface air film	–	0.120

Notes to Table 2-1:

⁽¹⁾ The framing, whose R-value is 0.001, is installed with this component, is spaced < 500 mm and contains no insulation.

The overall weight of the assembly in Figure 2-1 is 33.9 kg/m² and its heat capacity is 35.3 kJ/(m²×°C).

A-8.4.4.4.(2) Thermal Characteristics of the Space. The following are examples of space components that affect thermal mass: layout, furnishings, interior wall and floor construction, library stacks, etc.

A-8.4.4.5.(3) Controls Based on Space Occupancy. Subsection 4.2.2. presents several prescriptive control requirements for various space types. In establishing the reference building's energy consumption, the controls resulting in the highest energy consumption can be selected where compliance options are provided.

A-8.4.4.5.(6) Depth of Sidelighted Areas. The depth of sidelighted areas is affected by window head height and obstructions within the space. Obstructions cannot be established for the reference building, therefore, the 2 m default depth stipulated in Sentence 8.4.4.5.(6) is to account for hypothetical obstructions, such as the walls of closed offices, high partitions, etc., that could be present within a single thermal block.

A-8.4.4.5.(7) Daylighted Area under Skylights. For the purpose of energy model calculations for the reference building, it is assumed that the toplighting contributions are from skylights only and not roof monitors.

A-8.4.4.5.(10)(b) Reflectance. The reflectance values stated in Clause 8.4.4.5.(10)(b) take into account obstructions such as the walls of enclosed offices, high partitions, furniture, etc., that could be present within a single thermal block.

A-8.4.4.5.(11) Illumination Set-points. See Table A-8.4.3.2.(2)-B for representative illuminance levels to be used as modeling guidance.

A-8.4.4.8. Equipment Oversizing. Oversizing is an accepted industry practice that is implemented when safety factors are applied on the calculated load, when the reserve capacity for future use is included, or when equipment precisely matching the building's calculated load is not available on the market. However, gross oversizing can lead to the inefficient operation of equipment: for example, poor efficiency when equipment is operating at part-load. The 30% oversizing for heating equipment, which includes pick-up loads, and the 10% oversizing for cooling equipment stated in Article 8.4.4.8. are upper limits selected to avoid gross oversizing when modeling the reference building.

A-8.4.4.13. Heat Pump Definitions. The following types of heat pump systems are the most commonly used:

- Water-loop heat pump system: a heat pump system connected to an internal water loop used as a heat source and/or sink. The loop may include an auxiliary heat source (e.g. a boiler) and/or heat rejection device (e.g. a cooling tower)
- Air-source heat pump system: a heat pump system using the outside air as a heat source and/or sink
- Water-source heat pump system: a water-loop heat pump system using surface water (e.g. river, pond or lake), groundwater, or a water loop carrying waste heat generated outside the building as a heat source and/or sink, either directly, or indirectly through the use of a heat exchanger that separates the source from an internal water loop
- Ground-source heat pump system: a heat pump system using the ground as a heat source and/or sink through the use of a ground-heat exchanger in which circulates either a refrigerant supplied by the heat pump or a heat transfer liquid coming from an internal water loop

A-8.4.4.13.(1) Use of Heat Pumps. Sentence 8.4.4.13.(1) is intended to apply to heat pump systems that are used for space conditioning, not for heat-recovery applications.

A-8.4.4.14.(2) Hydronic Systems with Multiple Pumps. Where the proposed building uses multiple pumps in its hydronic systems (for example, a primary-secondary hot water hydronic system), representing these pumps as a single pump in the reference building must ensure that the same peak power is demanded by adjusting the pump head accordingly, based on a flow-weighted average pump efficiency (in order to correctly account for the heat gain due to water passing through the system).

Example 1

If the proposed building has the following characteristics:

- a boiler plant with an output capacity of 200 kW that uses a primary-secondary pumping system having the following three pumps:
 - a primary pump (boiler plant) with 86 L/min with a head of 60 kPa and 60% efficiency,
 - secondary pump (north wing) with 78 L/min with a head of 100 kPa and 50% efficiency,
 - a secondary pump (south wing) with 103 L/min with a head of 120 kPa and 45% efficiency, and
- a total shaft power demand of 861 W,

then, assuming the same output capacity of the reference building, the pump would be modeled with the following characteristics:

- a flow rate of 179.4 L/min (at a 16°C temperature differential),
- 54.2% efficiency,
- a shaft power demand of 861 W (which is the same as for the proposed building), and
- a pump head of 156.1 kPa.

A-8.4.4.17.(1) Exhaust Fans. Sentence 8.4.4.17.(1) refers to exhaust fans such as, but not limited to, those used to exhaust laboratory hoods, smoke, grease-laden vapours, toxic, flammable, paint or corrosive fumes or dust directly to the outside. Since such fans don't count against the fan power limitations stated in Sentences 5.2.3.2.(1) and 5.2.3.3.(1) and are not required to have their exhaust airstream equipped with an energy recovery system, they can be modeled identically in the reference building. Otherwise, the reference building model should either count them against the fan power limitation or equip them with energy recovery systems, as appropriate.

A-8.4.4.17.(2) Fan Part-Load Curves. Figure A-8.4.4.17.(2) illustrates the equations for fan power versus flow rate as a graph.

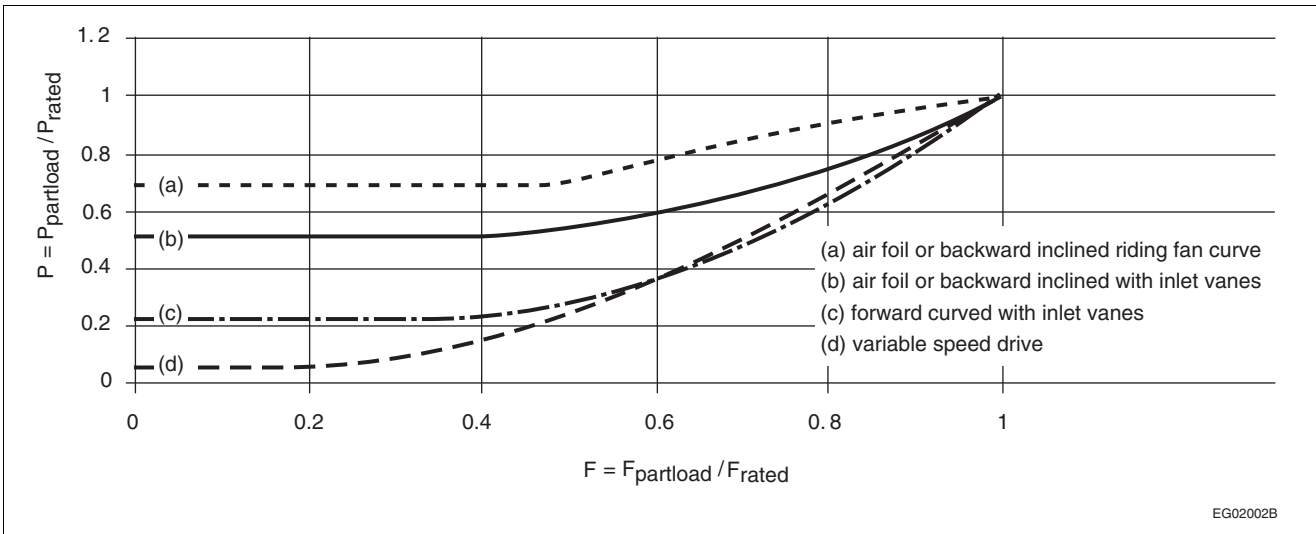

EG02002B

Figure A-8.4.17.(2)
Fan part-load curves

A-8.4.4.20.(4)(a) Determining the Heat Contribution Ratio. If the ratio of the heat contributions between the various energy types cannot be determined based on design information, the ratio can be determined by running a simulation of the proposed building.

A-8.4.4.20.(6) Service Water Heating System Supply Temperature. Article 2.2.10.7. of Division B of the NPC contains maximum temperature requirements based on type of fixture.

A-8.4.4.20.(7) Service Water Heating System Storage Temperature. Article 2.6.1.12. of Division B of the NPC establishes the minimum storage temperature of water in certain service water heating systems.

Division B

Part 9
Reserved

Division B

Part 10

Tiered Building Energy Performance Compliance

10.1.	General	
10.1.1.	General	10-1
10.1.2.	Compliance	10-1
10.2.	Objective and Functional Statements	
10.2.1.	Objective and Functional Statements	10-2
	Notes to Part 10	10-3

Part 10

Tiered Building Energy Performance Compliance

Section 10.1. General

10.1.1. General

10.1.1.1. Scope

1) Compliance with this Code is permitted to be achieved by applying the provisions of this Part in lieu of

- a) the prescriptive requirements in Sections 3.2., 4.2., 5.2., 6.2. and 7.2., or
- b) the trade-off provisions in Sections 3.3. and 4.3.

(See Note A-1.1.2.1.)

10.1.1.2. Application

1) This Part applies only to *buildings*

- a) whose *occupancy* is known, and
- b) except as provided in Sentence (2), for which sufficient information is known about their components, materials and assemblies that are covered by the scope of this Code.

2) Where insufficient information is known about the *building* components, materials and assemblies, the applicable prescriptive requirements in Sections 3.2., 4.2., 5.2., 6.2. and 7.2. shall apply.

3) If, during construction, the design is found to be altered from the one used in the original performance assessment, the *building* shall be reassessed for compliance with this Part.

4) Except as provided in Sentence (5), the procedures stated in this Part shall be applied to a single *building* at a time.

5) Where the structure is divided by *firewalls* into multiple *buildings*, the whole structure is permitted to be treated as one *building*.

10.1.2. Compliance

10.1.2.1. Compliance

1) Compliance with this Part shall be achieved by designing and constructing *buildings* in accordance with one of Energy Performance Tiers 1 to 4 specified in Table 10.1.2.1., each of which corresponds to

- a) the *annual energy consumption* of the proposed *building*, expressed as a percent *building energy target*, or
- b) the percentage of improvement of the *annual energy consumption* of the proposed *building* relative to the *building energy target* of the reference *building*, expressed as a percent improvement.

Table 10.1.2.1.
Energy Performance Tiers
 Forming Part of Sentences 10.1.2.1.(1) and (2)

Energy Performance Tier	Percent <i>Building Energy Target</i> ⁽¹⁾	Percent Improvement ⁽¹⁾
1	≤ 100%	≥ 0%
2	≤ 75%	≥ 25%
3	≤ 50%	≥ 50%
4	≤ 40%	≥ 60%

Notes to Table 10.1.2.1.:

⁽¹⁾ See Sentence (2).

- 2)** Compliance of the proposed *building* with one of Energy Performance Tiers 1 to 4 specified in Table 10.1.2.1. shall be determined by modeling the proposed and reference *buildings* in accordance with Part 8 to establish the *annual energy consumption* of the proposed *building* and the *building energy target* of the reference *building* then
- dividing the *annual energy consumption* of the proposed *building* by the *building energy target* of the reference *building* to derive the percent *building energy target*, or
 - subtracting the *annual energy consumption* of the proposed *building* from the *building energy target* of the reference *building* and dividing the result by the *building energy target* of the reference *building* to derive the percent improvement.

(See Note A-10.1.2.1.(2).)

Section 10.2. Objective and Functional Statements

10.2.1. Objective and Functional Statements

10.2.1.1. Attributions to Acceptable Solutions

- 1)** For the purpose of compliance with this Code as required in Clause 1.2.1.1.(1)(b) of Division A, the objective and functional statements attributed to the acceptable solutions in this Part shall be the objective and functional statements listed in Table 10.2.1.1. (See Note A-1.1.3.1.(1).)

Table 10.2.1.1.
Objectives and Functional Statements Attributed to the
Acceptable Solutions in Part 10
 Forming Part of Sentence 10.2.1.1.(1)

Provision	Functional Statements and Objectives ⁽¹⁾
10.1.1.2. Application	
(1)	[F99-OE1.1]
(3)	[F99-OE1.1]
(4)	[F99-OE1.1]
10.1.2.1. Compliance	
(1)	[F92,F93,F94,F95,F96,F97,F98,F99,F100-OE1.1]
(2)	[F92,F93,F94,F95,F96,F97,F98,F99,F100-OE1.1]

Notes to Table 10.2.1.1.:

⁽¹⁾ See Parts 2 and 3 of Division A.

Notes to Part 10

Tiered Building Energy Performance Compliance

A-10.1.2.1.(2) Determining Compliance with Energy Performance Tiers. The following examples illustrate the calculations of the percentage of the building energy target and the percentage of improvement described in Sentence 10.1.2.1.(2).

Example 1

If the modeled building energy target of the reference building equals 200 GJ and the modeled annual energy consumption of the proposed building equals 150 GJ, compliance of the proposed building with one of the Energy Performance Tiers can be calculated in one of two ways:

- (1) as a percent building energy target: $150/200 = 0.75$, or 75%, or
- (2) as a percent improvement: $200 - 150 = 50$; then $50/200 = 0.25$, or 25%.

The proposed building, as designed, therefore complies with Energy Performance Tier 2.

Example 2

If the modeled building energy target of the reference building equals 200 GJ and the modeled annual energy consumption of the proposed building equals 160 GJ, then the proposed building, as designed, complies with Tier 1:

- (1) as a percent building energy target: $160/200 = 0.80$, or 80%, or
- (2) as a percent improvement: $200 - 160 = 40$; then $40/200 = 0.20$, or 20%.

Division B

Climatic Information for Building Design in Canada

Table C-1, which is referenced in Sentence 1.1.4.1.(1), represents a partial reproduction of Table C-2 of Division B of the NBC (see the section on Climatic and Seismic Information for Building Design in Canada in the NBC for further information on these climatic data categories). The additional data for “Degree-Days Below 15°C” was developed by Environment and Climate Change Canada for inclusion in the NECB.

Table C-1
Design Data for Selected Locations in Canada

Province and Location	Elev., m	Design Temperature				Degree-Days Below 18°C	Degree-Days Below 15°C	Hourly Wind Pressures, kPa ⁽¹⁾	
		January		July 2.5%				1/10	1/50
		2.5% °C	1% °C	Dry °C	Wet °C				
British Columbia									
100 Mile House	1040	-30	-32	29	17	5030	4040	0.27	0.35
Abbotsford	70	-8	-10	29	20	2860	2000	0.33	0.44
Agassiz	15	-9	-11	31	21	2750	1900	0.35	0.47
Alberni	12	-5	-8	31	19	3100	2220	0.24	0.32
Ashcroft	305	-24	-27	34	20	3700	2790	0.29	0.38
Bamfield	20	-2	-4	23	17	3080	2060	0.38	0.50
Beaton River	840	-37	-39	26	18	6300	5230	0.23	0.30
Bella Bella	25	-5	-7	23	18	3180	2150	0.40	0.50
Bella Coola	40	-14	-18	27	19	3560	2660	0.29	0.39
Burns Lake	755	-31	-34	26	17	5450	4430	0.29	0.39
Cache Creek	455	-24	-27	34	20	3700	2790	0.29	0.39
Campbell River	20	-5	-7	26	18	3000	2130	0.41	0.48
Carmi	845	-24	-26	31	19	4750	3770	0.29	0.38
Castlegar	430	-18	-20	32	20	3580	2680	0.26	0.34
Chetwynd	605	-35	-38	27	18	5500	4480	0.30	0.40
Chilliwack	10	-9	-11	30	20	2780	1920	0.35	0.47
Comox	15	-7	-9	27	18	2930	2220	0.41	0.48
Courtenay	10	-7	-9	28	18	2930	2220	0.41	0.48
Cranbrook	910	-26	-28	32	18	4400	3450	0.25	0.33
Crescent Valley	585	-18	-20	31	20	3650	2740	0.25	0.33
Crofton	5	-4	-6	28	19	2880	2020	0.32	0.40
Dawson Creek	665	-38	-40	27	18	5900	4860	0.30	0.40
Dease Lake	800	-37	-40	24	15	6730	5630	0.23	0.30
Dog Creek	450	-28	-30	29	17	4800	3820	0.27	0.35
Duncan	10	-6	-8	28	19	2980	2110	0.31	0.39

Table C-1 (Continued)

Province and Location	Elev., m	Design Temperature				Degree-Days Below 18°C	Degree-Days Below 15°C	Hourly Wind Pressures, kPa ⁽¹⁾	
		January		July 2.5%				1/10	1/50
		2.5% °C	1% °C	Dry °C	Wet °C				
Elko	1065	-28	-31	30	19	4600	3630	0.30	0.40
Fernie	1010	-27	-30	30	19	4750	3770	0.30	0.40
Fort Nelson	465	-39	-42	28	18	6710	5740	0.23	0.30
Fort St. John	685	-35	-37	26	18	5750	4710	0.29	0.39
Glacier	1145	-27	-30	27	17	5800	4760	0.24	0.32
Golden	790	-27	-30	30	17	4750	3770	0.26	0.35
Gold River	120	-8	-11	31	18	3230	2350	0.24	0.32
Grand Forks	565	-19	-22	34	20	3820	2900	0.30	0.40
Greenwood	745	-20	-23	34	20	4100	3160	0.30	0.40
Hope	40	-13	-15	31	20	2820	2130	0.47	0.63
Jordan River	20	-1	-3	22	17	2900	1900	0.44	0.55
Kamloops	355	-23	-25	34	20	3450	2670	0.30	0.40
Kaslo	545	-17	-20	30	19	3830	2910	0.23	0.31
Kelowna	350	-17	-20	33	20	3400	2510	0.30	0.40
Kimberley	1090	-25	-27	31	18	4650	3680	0.25	0.33
Kitimat Plant	15	-16	-18	25	16	3750	2830	0.36	0.48
Kitimat Townsite	130	-16	-18	24	16	3900	2980	0.36	0.48
Ladysmith	80	-7	-9	27	19	2920	2130	0.32	0.40
Langford	80	-4	-6	27	19	2750	1770	0.32	0.40
Lillooet	245	-21	-23	34	20	3400	2610	0.33	0.44
Lytton	325	-17	-20	35	20	3300	2410	0.32	0.43
Mackenzie	765	-34	-38	27	17	5550	4530	0.25	0.32
Masset	10	-5	-7	17	15	3700	2600	0.50	0.61
McBride	730	-29	-32	29	18	4980	3990	0.27	0.35
McLeod Lake	695	-35	-37	27	17	5450	4430	0.25	0.32
Merritt	570	-24	-27	34	20	3900	2980	0.33	0.44
Mission City	45	-9	-11	30	20	2850	1990	0.32	0.43
Montrose	615	-16	-18	32	20	3600	2690	0.26	0.35
Nakusp	445	-20	-22	31	20	3560	2660	0.25	0.33
Nanaimo	15	-6	-8	27	19	2920	2130	0.38	0.48
Nelson	600	-18	-20	31	20	3500	2600	0.25	0.33
Ocean Falls	10	-10	-12	23	17	3400	2510	0.44	0.59
Osoyoos	285	-14	-17	35	21	3100	2220	0.30	0.40
Parksville	40	-6	-8	26	19	2990	2320	0.40	0.48
Penticton	350	-15	-17	33	20	3350	2460	0.30	0.40
Port Alberni	15	-5	-8	31	19	3100	2220	0.24	0.32
Port Alice	25	-3	-6	26	17	3010	2000	0.24	0.32
Port Hardy	5	-5	-7	20	16	3440	2370	0.36	0.48
Port McNeill	5	-5	-7	22	17	3410	2350	0.36	0.48
Port Renfrew	20	-3	-5	24	17	2900	1900	0.42	0.52
Powell River	10	-7	-9	26	18	3100	2220	0.39	0.48

Division B

Table C-1 (Continued)

Province and Location	Elev., m	Design Temperature				Degree-Days Below 18°C	Degree-Days Below 15°C	Hourly Wind Pressures, kPa ⁽¹⁾	
		January		July 2.5%				1/10	1/50
		2.5% °C	1% °C	Dry °C	Wet °C				
Prince George	580	-32	-36	28	18	4720	3750	0.28	0.37
Prince Rupert	20	-13	-15	19	15	3900	2770	0.43	0.54
Princeton	655	-24	-29	33	19	4250	3300	0.27	0.36
Qualicum Beach	10	-7	-9	27	19	2990	2320	0.41	0.48
Queen Charlotte City	35	-6	-8	21	16	3520	2440	0.50	0.61
Quesnel	475	-31	-33	30	17	4650	3680	0.24	0.31
Revelstoke	440	-20	-23	31	19	4000	3070	0.24	0.32
Salmon Arm	425	-19	-24	33	21	3650	2740	0.29	0.39
Sandspit	5	-4	-6	18	15	3450	2380	0.59	0.72
Sechelt	25	-6	-8	27	20	2680	1830	0.38	0.48
Sidney	10	-4	-6	26	18	2850	1860	0.34	0.42
Smithers	500	-29	-31	26	17	5040	4050	0.30	0.40
Smith River	660	-45	-47	26	17	7100	5980	0.24	0.30
Sooke	20	-1	-3	21	16	2900	1900	0.38	0.48
Squamish	5	-9	-11	29	20	2950	2080	0.38	0.50
Stewart	10	-17	-20	25	16	4350	3400	0.27	0.36
Tahsis	25	-4	-6	26	18	3150	2120	0.26	0.34
Taylor	515	-35	-37	26	18	5720	4690	0.30	0.40
Terrace	60	-19	-21	27	17	4150	3210	0.27	0.36
Tofino	10	-2	-4	20	16	3150	2120	0.51	0.68
Trail	440	-14	-17	33	20	3600	2690	0.26	0.35
Ucluelet	5	-2	-4	18	16	3120	2100	0.51	0.68
Vancouver Region									
Burnaby (Simon Fraser Univ.)	330	-7	-9	25	17	3100	2220	0.35	0.47
Cloverdale	10	-8	-10	29	20	2700	1850	0.33	0.44
Haney	10	-9	-11	30	20	2840	1980	0.33	0.44
Ladner	3	-6	-8	27	19	2600	1750	0.37	0.46
Langley	15	-8	-10	29	20	2700	1850	0.33	0.44
New Westminster	10	-8	-10	29	19	2800	1940	0.33	0.44
North Vancouver	135	-7	-9	26	19	2910	2050	0.34	0.45
Richmond	5	-7	-9	27	19	2800	1940	0.36	0.45
Surrey (88 Ave & 156 St.)	90	-8	-10	29	20	2750	1900	0.33	0.44
Vancouver (City Hall)	40	-7	-9	28	20	2825	1970	0.34	0.45
Vancouver (Granville St. & 41st Ave)	120	-6	-8	28	20	2925	2060	0.36	0.45
West Vancouver	45	-7	-9	28	19	2950	2080	0.36	0.48
Vernon	405	-20	-23	33	20	3600	2690	0.30	0.40
Victoria Region									
Victoria	10	-4	-6	24	17	2650	1730	0.46	0.57
Victoria (Gonzales Hts)	65	-4	-6	24	17	2700	1690	0.46	0.57

Table C-1 (Continued)

Province and Location	Elev., m	Design Temperature				Degree-Days Below 18°C	Degree-Days Below 15°C	Hourly Wind Pressures, kPa ⁽¹⁾	
		January		July 2.5%				1/10	1/50
		2.5% °C	1% °C	Dry °C	Wet °C				
Victoria (Mt Tolmie)	125	-6	-8	24	16	2700	1730	0.46	0.57
Whistler	665	-17	-20	30	20	4180	3240	0.24	0.32
White Rock	30	-5	-7	25	20	2620	1770	0.33	0.44
Williams Lake	615	-30	-33	29	17	4400	3450	0.27	0.35
Youbou	200	-5	-8	31	19	3050	2180	0.26	0.32
Alberta									
Athabasca	515	-35	-38	27	19	6000	5000	0.27	0.36
Banff	1400	-31	-33	27	16	5500	4520	0.26	0.32
Barrhead	645	-33	-36	27	19	5740	4750	0.35	0.44
Beaverlodge	730	-36	-39	28	18	5700	4710	0.27	0.36
Brooks	760	-32	-34	32	20	4880	3940	0.35	0.44
Calgary	1045	-30	-32	28	17	5000	4050	0.38	0.48
Campsie	660	-33	-36	27	19	5750	4760	0.33	0.44
Camrose	740	-33	-35	29	19	5500	4520	0.31	0.39
Canmore	1320	-31	-33	28	17	5400	4430	0.30	0.37
Cardston	1130	-29	-32	30	19	4700	3770	0.58	0.72
Claresholm	1030	-30	-32	30	18	4680	3750	0.46	0.58
Cold Lake	540	-35	-38	28	19	5860	4860	0.29	0.38
Coleman	1320	-31	-34	29	18	5210	4250	0.50	0.63
Coronation	790	-32	-34	30	19	5640	4660	0.30	0.37
Cowley	1175	-29	-32	29	18	4810	3870	0.81	1.01
Drumheller	685	-32	-34	30	18	5050	4100	0.35	0.44
Edmonton	645	-30	-33	28	19	5120	4160	0.36	0.45
Edson	920	-34	-37	27	18	5750	4760	0.37	0.46
Embaras Portage	220	-41	-43	28	19	7100	6040	0.28	0.37
Fairview	670	-37	-40	27	18	5840	4850	0.26	0.35
Fort MacLeod	945	-30	-32	31	19	4600	3670	0.54	0.68
Fort McMurray	255	-38	-40	28	19	6250	5230	0.28	0.35
Fort Saskatchewan	610	-32	-35	28	19	5420	4450	0.34	0.43
Fort Vermilion	270	-41	-43	28	18	6700	5660	0.23	0.30
Grande Prairie	650	-36	-39	27	18	5790	4800	0.32	0.43
Habay	335	-41	-43	28	18	6750	5710	0.23	0.30
Hardisty	615	-33	-36	30	19	5640	4660	0.29	0.36
High River	1040	-31	-32	28	17	4900	3960	0.52	0.65
Hinton	990	-34	-38	27	17	5500	4520	0.37	0.46
Jasper	1060	-31	-34	28	17	5300	4330	0.26	0.32
Keg River	420	-40	-42	28	18	6520	5490	0.23	0.30
Lac La Biche	560	-35	-38	28	19	6100	5090	0.27	0.36
Lacombe	855	-33	-36	28	19	5500	4520	0.32	0.40
Lethbridge	910	-30	-32	31	19	4500	3580	0.53	0.66
Manning	465	-39	-41	27	18	6300	5280	0.23	0.30

Division B**Table C-1 (Continued)**

Province and Location	Elev., m	Design Temperature				Degree-Days Below 18°C	Degree-Days Below 15°C	Hourly Wind Pressures, kPa ⁽¹⁾	
		January		July 2.5%				1/10	1/50
		2.5% °C	1% °C	Dry °C	Wet °C				
Medicine Hat	705	-31	-34	32	19	4540	3610	0.38	0.48
Peace River	330	-37	-40	27	18	6050	5040	0.24	0.32
Pincher Creek	1130	-29	-32	29	18	4740	3800	0.77	0.96
Ranfurly	670	-34	-37	29	19	5700	4710	0.29	0.36
Red Deer	855	-32	-35	28	19	5550	4570	0.32	0.40
Rocky Mountain House	985	-32	-34	27	18	5640	4660	0.29	0.36
Slave Lake	590	-35	-38	26	19	5850	4850	0.28	0.37
Stettler	820	-32	-34	30	19	5300	4330	0.29	0.36
Stony Plain	710	-32	-35	28	19	5300	4330	0.36	0.45
Suffield	755	-31	-34	32	20	4770	3830	0.39	0.49
Taber	815	-31	-33	31	19	4580	3650	0.50	0.63
Turner Valley	1215	-31	-32	28	17	5220	4260	0.52	0.65
Valleyview	700	-37	-40	27	18	5600	4620	0.34	0.42
Vegreville	635	-34	-37	29	19	5780	4790	0.29	0.36
Vermilion	580	-35	-38	29	19	5740	4750	0.29	0.36
Wagner	585	-35	-38	26	19	5850	4850	0.28	0.37
Wainwright	675	-33	-36	29	19	5700	4710	0.29	0.36
Wetaskiwin	760	-33	-35	29	19	5500	4520	0.31	0.39
Whitecourt	690	-33	-36	27	19	5650	4670	0.28	0.37
Wimborne	975	-31	-34	29	18	5310	4340	0.32	0.40
Saskatchewan									
Assiniboia	740	-32	-34	31	21	5180	4300	0.39	0.49
Batrum	700	-32	-34	32	20	5080	4210	0.43	0.54
Biggar	645	-34	-36	30	20	5720	4820	0.36	0.45
Broadview	600	-34	-35	30	21	5760	4850	0.36	0.46
Dafoe	530	-35	-37	29	21	5860	4950	0.29	0.37
Dundurn	525	-35	-37	30	21	5600	4700	0.36	0.46
Estevan	565	-32	-34	32	22	5340	4450	0.41	0.52
Hudson Bay	370	-36	-38	29	21	6280	5350	0.29	0.37
Humboldt	565	-36	-38	28	21	6000	5080	0.31	0.39
Island Falls	305	-39	-41	27	20	7100	6130	0.26	0.35
Kamsack	455	-34	-37	29	22	6040	5120	0.32	0.40
Kindersley	685	-33	-35	31	20	5550	4650	0.36	0.46
Lloydminster	645	-34	-37	28	20	5880	4970	0.32	0.40
Maple Creek	765	-31	-34	31	20	4780	3920	0.36	0.45
Meadow Lake	480	-38	-40	28	20	6280	5350	0.30	0.40
Melfort	455	-36	-38	28	21	6050	5130	0.28	0.36
Melville	550	-34	-36	29	21	5880	4970	0.32	0.40
Moose Jaw	545	-32	-34	31	21	5270	4390	0.41	0.52
Nipawin	365	-37	-39	28	21	6300	5370	0.30	0.38
North Battleford	545	-34	-36	29	20	5900	4990	0.36	0.46

Table C-1 (Continued)

Province and Location	Elev., m	Design Temperature				Degree-Days Below 18°C	Degree-Days Below 15°C	Hourly Wind Pressures, kPa ⁽¹⁾	
		January		July 2.5%				1/10	1/50
		2.5% °C	1% °C	Dry °C	Wet °C				
Prince Albert	435	-37	-40	28	21	6100	5180	0.30	0.38
Qu'Appelle	645	-34	-36	30	22	5620	4720	0.33	0.42
Regina	575	-34	-36	31	21	5600	4700	0.39	0.49
Rosetown	595	-34	-36	31	20	5620	4720	0.39	0.49
Saskatoon	500	-35	-37	30	21	5700	4800	0.36	0.46
Scott	645	-34	-36	30	20	5960	5040	0.36	0.45
Strasbourg	545	-34	-36	30	22	5600	4700	0.33	0.42
Swift Current	750	-31	-34	31	20	5150	4270	0.43	0.54
Uranium City	265	-42	-44	26	19	7500	6510	0.27	0.36
Weyburn	575	-33	-35	31	23	5400	4510	0.38	0.48
Yorkton	510	-34	-37	29	21	6000	5080	0.32	0.40
Manitoba									
Beausejour	245	-33	-35	29	23	5680	4780	0.32	0.41
Boissevain	510	-32	-34	30	23	5500	4610	0.41	0.52
Brandon	395	-33	-35	30	22	5760	4850	0.39	0.49
Churchill	10	-38	-40	25	18	8950	7890	0.43	0.55
Dauphin	295	-33	-35	30	22	5900	4990	0.32	0.40
Flin Flon	300	-38	-40	27	20	6440	5500	0.28	0.35
Gimli	220	-34	-36	29	23	5800	4890	0.32	0.40
Island Lake	240	-36	-38	27	20	6900	5940	0.29	0.37
Lac du Bonnet	260	-34	-36	29	23	5730	4830	0.29	0.37
Lynn Lake	350	-40	-42	27	19	7770	6770	0.29	0.37
Morden	300	-31	-33	30	24	5400	4510	0.41	0.52
Neepawa	365	-32	-34	29	23	5760	4850	0.35	0.44
Pine Falls	220	-34	-36	28	23	5900	4990	0.31	0.39
Portage la Prairie	260	-31	-33	30	23	5600	4700	0.36	0.46
Rivers	465	-34	-36	29	23	5840	4930	0.36	0.46
Sandilands	365	-32	-34	29	23	5650	4750	0.32	0.40
Selkirk	225	-33	-35	29	23	5700	4800	0.32	0.41
Split Lake	175	-38	-40	27	19	7900	6890	0.31	0.39
Steinbach	270	-33	-35	29	23	5700	4800	0.32	0.40
Swan River	335	-34	-37	29	22	6100	5180	0.28	0.35
The Pas	270	-36	-38	28	21	6480	5540	0.29	0.37
Thompson	205	-40	-43	27	19	7600	6600	0.28	0.36
Virden	435	-33	-35	30	23	5620	4720	0.36	0.46
Winnipeg	235	-33	-35	30	23	5670	4770	0.36	0.45
Ontario									
Ailsa Craig	230	-17	-19	30	23	3840	3050	0.37	0.48
Ajax	95	-20	-22	30	23	3820	3030	0.37	0.48
Alexandria	80	-24	-26	30	23	4600	3740	0.31	0.40
Alliston	220	-23	-25	29	23	4200	3380	0.28	0.36

Division B

Table C-1 (Continued)

Province and Location	Elev., m	Design Temperature				Degree-Days Below 18°C	Degree-Days Below 15°C	Hourly Wind Pressures, kPa ⁽¹⁾	
		January		July 2.5%				1/10	1/50
		2.5% °C	1% °C	Dry °C	Wet °C				
Almonte	120	-26	-28	30	23	4620	3760	0.32	0.41
Armstrong	340	-37	-40	28	21	6500	5530	0.22	0.30
Arnprior	85	-27	-29	30	23	4680	3820	0.29	0.37
Atikokan	400	-33	-35	29	22	5750	4810	0.22	0.30
Attawapiskat	10	-37	-39	28	21	7100	6120	0.30	0.41
Aurora	270	-21	-23	30	23	4210	3390	0.34	0.44
Bancroft	365	-28	-31	29	23	4740	3870	0.25	0.32
Barrie	245	-24	-26	29	23	4380	3540	0.28	0.36
Barriefield	100	-22	-24	28	23	3990	3190	0.37	0.47
Beaverton	240	-24	-26	30	23	4300	3470	0.28	0.36
Belleville	90	-22	-24	29	23	3910	3110	0.34	0.43
Belmont	260	-17	-19	30	24	3840	3050	0.37	0.47
Borden (CFB)	225	-23	-25	29	23	4300	3470	0.28	0.36
Bracebridge	310	-26	-28	29	23	4800	3920	0.27	0.35
Bradford	240	-23	-25	30	23	4280	3450	0.28	0.36
Brampton	215	-19	-21	30	23	4100	3290	0.34	0.44
Brantford	205	-18	-20	30	23	3900	3110	0.33	0.42
Brighton	95	-21	-23	29	23	4000	3200	0.37	0.48
Brockville	85	-23	-25	29	23	4060	3250	0.34	0.44
Burk's Falls	305	-26	-28	29	22	5020	4120	0.27	0.35
Burlington	80	-17	-19	31	23	3740	2960	0.36	0.46
Cambridge	295	-18	-20	29	23	4100	3290	0.28	0.36
Campbellford	150	-23	-26	30	23	4280	3450	0.32	0.41
Cannington	255	-24	-26	30	23	4310	3480	0.28	0.36
Carleton Place	135	-25	-27	30	23	4600	3740	0.32	0.41
Cavan	200	-23	-25	30	23	4400	3560	0.34	0.44
Centralia	260	-17	-19	30	23	3800	3010	0.37	0.48
Chapleau	425	-35	-38	27	21	5900	4950	0.23	0.30
Chatham	180	-16	-18	31	24	3470	2710	0.34	0.43
Chesley	275	-19	-21	29	22	4320	3490	0.35	0.45
Clinton	280	-17	-19	29	23	4150	3330	0.36	0.46
Coboconk	270	-25	-27	30	23	4500	3650	0.27	0.35
Cobourg	90	-21	-23	29	23	3980	3180	0.38	0.49
Cochrane	245	-34	-36	29	21	6200	5240	0.27	0.35
Colborne	105	-21	-23	29	23	3980	3180	0.38	0.49
Collingwood	190	-21	-23	29	23	4180	3360	0.30	0.39
Cornwall	35	-23	-25	30	23	4250	3420	0.32	0.41
Corunna	185	-16	-18	31	24	3600	2830	0.37	0.47
Deep River	145	-29	-32	30	22	4900	3980	0.27	0.35
Deseronto	85	-22	-24	29	23	4070	3260	0.34	0.43
Dorchester	260	-18	-20	30	24	3900	3110	0.37	0.47

Table C-1 (Continued)

Province and Location	Elev., m	Design Temperature				Degree-Days Below 18°C	Degree-Days Below 15°C	Hourly Wind Pressures, kPa ⁽¹⁾	
		January		July 2.5%				1/10	1/50
		2.5% °C	1% °C	Dry °C	Wet °C				
Dorion	200	-33	-35	28	21	5950	5000	0.29	0.39
Dresden	185	-16	-18	31	24	3750	2970	0.34	0.43
Dryden	370	-34	-36	28	22	5850	4940	0.22	0.30
Dundalk	525	-22	-24	29	22	4700	3830	0.33	0.42
Dunnville	175	-15	-17	30	24	3660	2890	0.36	0.46
Durham	340	-20	-22	29	22	4340	3510	0.34	0.44
Dutton	225	-16	-18	31	24	3700	2920	0.37	0.47
Earlton	245	-33	-36	29	22	5730	4790	0.35	0.45
Edison	365	-34	-36	28	22	5740	4840	0.23	0.31
Elliot Lake	380	-26	-28	29	21	4950	4030	0.30	0.38
Elmvale	220	-24	-26	29	23	4200	3380	0.28	0.36
Embro	310	-19	-21	30	23	3950	3150	0.37	0.48
Englehart	205	-33	-36	29	22	5800	4860	0.32	0.41
Espanola	220	-25	-27	29	21	4920	4000	0.33	0.42
Exeter	265	-17	-19	30	23	3900	3110	0.37	0.48
Fenelon Falls	260	-25	-27	30	23	4440	3600	0.28	0.36
Fergus	400	-20	-22	29	23	4300	3470	0.28	0.36
Forest	215	-16	-18	31	23	3740	2960	0.37	0.48
Fort Erie	180	-15	-17	30	24	3650	2880	0.36	0.46
Fort Erie (Ridgeway)	190	-15	-17	30	24	3600	2830	0.36	0.46
Fort Frances	340	-33	-35	29	22	5440	4550	0.23	0.31
Gananoque	80	-22	-24	28	23	4010	3210	0.37	0.47
Geraldton	345	-36	-39	28	21	6450	5490	0.22	0.30
Glencoe	215	-16	-18	31	24	3680	2900	0.34	0.43
Goderich	185	-16	-18	29	23	4000	3200	0.37	0.48
Gore Bay	205	-24	-26	28	22	4700	3830	0.34	0.44
Graham	495	-35	-37	29	22	5940	4990	0.22	0.30
Gravenhurst (Muskoka Airport)	255	-26	-28	29	23	4760	3890	0.28	0.36
Grimsby	85	-16	-18	30	23	3520	2760	0.36	0.46
Guelph	340	-19	-21	29	23	4270	3440	0.28	0.36
Guthrie	280	-24	-26	29	23	4300	3470	0.28	0.36
Haileybury	210	-32	-35	30	22	5600	4660	0.34	0.44
Haldimand (Caledonia)	190	-18	-20	30	23	3750	2970	0.34	0.44
Haldimand (Hagersville)	215	-17	-19	30	23	3760	2980	0.36	0.46
Haliburton	335	-27	-29	29	23	4840	3960	0.27	0.35
Halton Hills (Georgetown)	255	-19	-21	30	23	4200	3380	0.29	0.37
Hamilton	90	-17	-19	31	23	3460	2700	0.36	0.46
Hanover	270	-19	-21	29	22	4300	3470	0.34	0.44
Hastings	200	-24	-26	30	23	4280	3450	0.32	0.41

Division B

Table C-1 (Continued)

Province and Location	Elev., m	Design Temperature				Degree-Days Below 18°C	Degree-Days Below 15°C	Hourly Wind Pressures, kPa ⁽¹⁾	
		January		July 2.5%				1/10	1/50
		2.5% °C	1% °C	Dry °C	Wet °C				
Hawkesbury	50	-25	-27	30	23	4610	3750	0.32	0.41
Hearst	245	-35	-37	29	21	6450	5490	0.23	0.30
Honey Harbour	180	-24	-26	29	23	4300	3470	0.30	0.39
Hornepayne	360	-37	-40	28	21	6340	5380	0.22	0.30
Huntsville	335	-26	-29	29	22	4850	3970	0.27	0.35
Ingersoll	280	-18	-20	30	23	3920	3120	0.37	0.48
Iroquois Falls	275	-33	-36	29	21	6100	5150	0.29	0.37
Jellicoe	330	-36	-39	28	21	6400	5440	0.22	0.30
Kapuskasing	245	-34	-36	29	21	6250	5290	0.24	0.31
Kemptville	90	-25	-27	30	23	4540	3690	0.32	0.41
Kenora	370	-33	-35	28	22	5630	4730	0.23	0.31
Killaloe	185	-28	-31	30	22	4960	4070	0.27	0.35
Kincardine	190	-17	-19	28	22	3890	3100	0.37	0.48
Kingston	80	-22	-24	28	23	4000	3200	0.37	0.47
Kinmount	295	-26	-28	29	23	4600	3740	0.27	0.35
Kirkland Lake	325	-33	-36	29	22	6000	5050	0.30	0.39
Kitchener	335	-19	-21	29	23	4200	3380	0.29	0.37
Kitchenuhmaykoosib / Big Trout Lake	215	-38	-40	26	20	7450	–	0.31	0.42
Lakefield	240	-24	-26	30	23	4330	3500	0.30	0.38
Lansdowne House	240	-38	-40	28	21	7150	6160	0.24	0.32
Leamington	190	-15	-17	31	24	3400	2650	0.37	0.47
Lindsay	265	-24	-26	30	23	4320	3490	0.30	0.38
Lion's Head	185	-19	-21	27	22	4300	3470	0.37	0.48
Listowel	380	-19	-21	29	23	4300	3470	0.34	0.43
London	245	-18	-20	30	24	3900	3110	0.37	0.47
Lucan	300	-17	-19	30	23	3900	3110	0.37	0.48
Maitland	85	-23	-25	29	23	4080	3270	0.34	0.44
Markdale	425	-20	-22	29	22	4500	3650	0.32	0.41
Markham	175	-21	-23	31	24	4000	3200	0.34	0.44
Martin	485	-35	-37	29	22	5900	4950	0.22	0.30
Matheson	265	-33	-36	29	21	6080	5130	0.30	0.39
Mattawa	165	-29	-31	30	22	5050	4130	0.25	0.32
Midland	190	-24	-26	29	23	4200	3380	0.30	0.39
Milton	200	-18	-20	30	23	3920	3120	0.34	0.43
Milverton	370	-19	-21	29	23	4200	3380	0.34	0.43
Minden	270	-27	-29	29	23	4640	3780	0.27	0.35
Mississauga	160	-18	-20	30	23	3880	3090	0.34	0.44
Mississauga (Lester B. Pearson Int'l Airport)	170	-20	-22	31	24	3890	–	0.34	0.44
Mississauga (Port Credit)	75	-18	-20	29	23	3780	3000	0.37	0.48

Table C-1 (Continued)

Province and Location	Elev., m	Design Temperature				Degree-Days Below 18°C	Degree-Days Below 15°C	Hourly Wind Pressures, kPa ⁽¹⁾	
		January		July 2.5%				1/10	1/50
		2.5% °C	1% °C	Dry °C	Wet °C				
Mitchell	335	-18	-20	29	23	4100	3290	0.35	0.45
Moosonee	10	-36	-38	28	22	6800	5820	0.26	0.35
Morrisburg	75	-23	-25	30	23	4370	3530	0.32	0.41
Mount Forest	420	-21	-24	28	22	4700	3830	0.32	0.41
Nakina	325	-36	-38	28	21	6500	5530	0.22	0.30
Nanticoke (Jarvis)	205	-17	-18	30	23	3700	2920	0.37	0.48
Nanticoke (Port Dover)	180	-15	-17	30	24	3600	2830	0.37	0.48
Napanee	90	-22	-24	29	23	4140	3320	0.34	0.43
Newcastle	115	-20	-22	30	23	3990	3190	0.37	0.48
Newcastle (Bowmanville)	95	-20	-22	30	23	4000	—	0.37	0.48
New Liskeard	180	-32	-35	30	22	5570	4630	0.34	0.43
Newmarket	185	-22	-24	30	23	4260	3430	0.30	0.38
Niagara Falls	210	-16	-18	30	23	3600	2830	0.34	0.43
North Bay	210	-28	-30	28	22	5150	4230	0.27	0.34
Norwood	225	-24	-26	30	23	4320	3490	0.32	0.41
Oakville	90	-18	-20	30	23	3760	2980	0.37	0.47
Orangeville	430	-21	-23	29	23	4450	3610	0.28	0.36
Orillia	230	-25	-27	29	23	4260	3430	0.28	0.36
Oshawa	110	-19	-21	30	23	3860	3070	0.37	0.48
Ottawa (Metropolitan)									
Ottawa (City Hall)	70	-25	-27	30	23	4440	3600	0.32	0.41
Ottawa (Barrhaven)	98	-25	-27	30	23	4500	3650	0.32	0.41
Ottawa (Kanata)	98	-25	-27	30	23	4520	3670	0.32	0.41
Ottawa (M-C Int'l Airport)	125	-25	-27	30	23	4500	3650	0.32	0.41
Ottawa (Orléans)	70	-26	-28	30	23	4500	3650	0.32	0.41
Owen Sound	215	-19	-21	29	22	4030	3220	0.34	0.44
Pagwa River	185	-35	-37	28	21	6500	5530	0.22	0.30
Paris	245	-18	-20	30	23	4000	3200	0.33	0.42
Parkhill	205	-16	-18	31	23	3800	3010	0.37	0.48
Parry Sound	215	-24	-26	28	22	4640	3780	0.30	0.39
Pelham (Fonthill)	230	-15	-17	30	23	3690	2910	0.33	0.42
Pembroke	125	-28	-31	30	23	4980	4090	0.27	0.35
Penetanguishene	220	-24	-26	29	23	4200	3380	0.30	0.39
Perth	130	-25	-27	30	23	4540	3690	0.32	0.41
Petawawa	135	-29	-31	30	23	4980	4090	0.27	0.35
Peterborough	200	-23	-25	30	23	4400	3560	0.32	0.41
Petrolia	195	-16	-18	31	24	3640	2870	0.37	0.47
Pickering (Dunbarton)	85	-19	-21	30	23	3800	3010	0.37	0.48
Picton	95	-21	-23	29	23	3980	3180	0.38	0.49
Plattsville	300	-19	-21	29	23	4150	3330	0.33	0.42

Division B

Table C-1 (Continued)

Province and Location	Elev., m	Design Temperature				Degree-Days Below 18°C	Degree-Days Below 15°C	Hourly Wind Pressures, kPa ⁽¹⁾	
		January		July 2.5%				1/10	1/50
		2.5% °C	1% °C	Dry °C	Wet °C				
Point Alexander	150	-29	-32	30	22	4960	4040	0.27	0.35
Port Burwell	195	-15	-17	30	24	3800	3010	0.37	0.47
Port Colborne	180	-15	-17	30	24	3600	2830	0.36	0.46
Port Elgin	205	-17	-19	28	22	4100	3290	0.37	0.48
Port Hope	100	-21	-23	29	23	3970	3170	0.37	0.48
Port Perry	270	-22	-24	30	23	4260	3430	0.34	0.44
Port Stanley	180	-15	-17	31	24	3850	3060	0.37	0.47
Prescott	90	-23	-25	29	23	4120	3310	0.34	0.44
Princeton	280	-18	-20	30	23	4000	3200	0.33	0.42
Raith	475	-34	-37	28	22	5900	4950	0.22	0.30
Rayside-Balfour (Chelmsford)	270	-28	-30	29	21	5200	4280	0.35	0.45
Red Lake	360	-35	-37	28	21	6220	5290	0.22	0.30
Renfrew	115	-27	-30	30	23	4900	4020	0.27	0.35
Richmond Hill	230	-21	-23	31	24	4000	3200	0.34	0.44
Rockland	50	-26	-28	30	23	4600	3740	0.31	0.40
Sarnia	190	-16	-18	31	24	3750	2970	0.37	0.47
Sault Ste. Marie	190	-25	-28	29	22	4960	4040	0.33	0.44
Schreiber	310	-34	-36	27	21	5960	5010	0.29	0.39
Seaforth	310	-17	-19	30	23	4100	3290	0.35	0.45
Shelburne	495	-22	-24	29	23	4700	3830	0.31	0.40
Simcoe	210	-17	-19	30	24	3700	2920	0.35	0.45
Sioux Lookout	375	-34	-36	28	22	5950	5030	0.22	0.30
Smiths Falls	130	-25	-27	30	23	4540	3690	0.32	0.41
Smithville	185	-16	-18	30	23	3650	2880	0.33	0.42
Smooth Rock Falls	235	-34	-36	29	21	6250	5290	0.25	0.32
Southampton	180	-17	-19	28	22	4100	3290	0.37	0.48
South River	355	-27	-29	29	22	5090	4190	0.27	0.35
St. Catharines	105	-16	-18	30	23	3540	2780	0.36	0.46
St. Marys	310	-18	-20	30	23	4000	3200	0.37	0.47
St. Thomas	225	-16	-18	31	24	3780	3000	0.37	0.47
Stirling	120	-23	-25	30	23	4220	3400	0.31	0.40
Stratford	360	-18	-20	29	23	4050	3240	0.35	0.45
Strathroy	225	-17	-19	31	24	3780	3000	0.37	0.47
Sturgeon Falls	205	-28	-30	29	21	5200	4280	0.27	0.35
Sudbury	275	-28	-30	29	21	5180	4260	0.36	0.46
Sundridge	340	-27	-29	29	22	5080	4180	0.27	0.35
Tavistock	340	-19	-21	29	23	4100	3290	0.35	0.45
Temagami	300	-30	-33	30	22	5420	4490	0.29	0.37
Thamesford	280	-19	-21	30	23	3950	3150	0.37	0.48
Theford	205	-16	-18	31	23	3710	2930	0.37	0.48
Thunder Bay	210	-31	-33	29	21	5650	4710	0.29	0.39

Table C-1 (Continued)

Province and Location	Elev., m	Design Temperature				Degree-Days Below 18°C	Degree-Days Below 15°C	Hourly Wind Pressures, kPa ⁽¹⁾	
		January		July 2.5%				1/10	1/50
		2.5% °C	1% °C	Dry °C	Wet °C				
Tillsonburg	215	-17	-19	30	24	3840	3050	0.34	0.44
Timmins	300	-34	-36	29	21	5940	4990	0.27	0.35
Timmins (Porcupine)	295	-34	-36	29	21	6000	5050	0.29	0.37
Toronto Metropolitan Region									
Etobicoke	160	-20	-22	31	24	3800	3010	0.34	0.44
North York	175	-20	-22	31	24	3760	2980	0.34	0.44
Scarborough	180	-20	-22	31	24	3800	3010	0.37	0.47
Toronto (City Hall)	90	-18	-20	31	23	3520	2760	0.34	0.44
Trenton	80	-22	-24	29	23	4110	3300	0.37	0.47
Trout Creek	330	-27	-29	29	22	5100	4200	0.27	0.35
Uxbridge	275	-22	-24	30	23	4240	3410	0.33	0.42
Vaughan (Woodbridge)	165	-20	-22	31	24	4100	3290	0.34	0.44
Vittoria	215	-15	-17	30	24	3680	2900	0.37	0.47
Walkerton	275	-18	-20	30	22	4300	3470	0.36	0.46
Wallaceburg	180	-16	-18	31	24	3600	2830	0.35	0.45
Waterloo	330	-19	-21	29	23	4200	3380	0.29	0.37
Watford	240	-17	-19	31	24	3740	2960	0.37	0.47
Wawa	290	-34	-36	26	21	5840	4900	0.30	0.39
Welland	180	-15	-17	30	23	3670	2900	0.34	0.43
West Lorne	215	-16	-18	31	24	3700	2920	0.37	0.47
Whitby	85	-20	-22	30	23	3820	3030	0.37	0.48
Whitby (Brooklin)	160	-20	-22	30	23	4010	3210	0.35	0.45
White River	375	-39	-42	28	21	6150	5200	0.22	0.30
Warton	185	-19	-21	29	22	4300	3470	0.34	0.44
Windsor	185	-16	-18	32	24	3400	2650	0.37	0.47
Wingham	310	-18	-20	30	23	4220	3400	0.36	0.46
Woodstock	300	-19	-21	30	23	3910	3110	0.34	0.44
Wyoming	215	-16	-18	31	24	3700	2920	0.37	0.47
Quebec									
Acton Vale	95	-24	-27	30	23	4620	3790	0.27	0.35
Alma	110	-31	-33	28	22	5800	4860	0.27	0.35
Amos	295	-34	-36	28	21	6160	5210	0.25	0.32
Asbestos	245	-26	-28	29	22	4800	3890	0.27	0.35
Aylmer	90	-25	-28	30	23	4520	3620	0.32	0.41
Baie-Comeau	60	-27	-29	25	19	6020	5070	0.39	0.50
Baie-Saint-Paul	20	-27	-29	28	21	5280	4350	0.37	0.48
Beauport	45	-26	-29	28	22	5100	4180	0.33	0.42
Bedford	55	-24	-26	29	23	4420	3610	0.29	0.37
Beloil	25	-24	-26	30	23	4500	3680	0.29	0.37
Brome	210	-25	-27	29	23	4730	3880	0.29	0.37
Brossard	15	-24	-26	30	23	4420	3610	0.34	0.44

Division B

Table C-1 (Continued)

Province and Location	Elev., m	Design Temperature				Degree-Days Below 18°C	Degree-Days Below 15°C	Hourly Wind Pressures, kPa ⁽¹⁾	
		January		July 2.5%				1/10	1/50
		2.5% °C	1% °C	Dry °C	Wet °C				
Buckingham	130	-26	-28	30	23	4880	3970	0.31	0.40
Campbell's Bay	115	-28	-30	30	23	4900	3980	0.25	0.32
Chambly	20	-24	-26	30	23	4450	3630	0.31	0.40
Coaticook	295	-25	-27	28	22	4750	3840	0.27	0.35
Contrecoeur	10	-25	-27	30	23	4500	3680	0.34	0.43
Cowansville	120	-25	-27	29	23	4540	3710	0.29	0.37
Deux-Montagnes	25	-25	-27	29	23	4440	3630	0.29	0.37
Dolbeau	120	-32	-34	28	22	6250	5290	0.27	0.35
Drummondville	85	-26	-28	30	23	4700	3860	0.27	0.35
Farnham	60	-24	-26	29	23	4500	3680	0.29	0.37
Fort-Coulonge	110	-28	-30	30	23	4950	4030	0.25	0.32
Gagnon	545	-34	-36	24	19	7600	6600	0.30	0.39
Gaspé	55	-25	-26	26	20	5500	4570	0.37	0.48
Gatineau	95	-25	-28	30	23	4600	3690	0.32	0.41
Gracefield	175	-28	-31	30	23	5080	4160	0.25	0.32
Granby	120	-25	-27	29	23	4500	3680	0.27	0.35
Harrington Harbour	30	-27	-29	19	16	6150	5200	0.56	0.72
Havre-Saint-Pierre	5	-27	-29	22	18	6100	5150	0.49	0.63
Hemmingford	75	-24	-26	30	23	4380	3570	0.31	0.40
Hull	65	-25	-28	30	23	4550	3650	0.32	0.41
Iberville	35	-24	-26	29	23	4450	3630	0.32	0.41
Inukjuak	5	-36	-38	21	15	9150	8100	0.37	0.48
Joliette	45	-26	-28	29	23	4720	3870	0.28	0.36
Kuujuaq	25	-37	-39	24	17	8550	7520	0.47	0.60
Kuujuarapik	20	-36	-38	25	17	7990	6980	0.37	0.48
Lachute	65	-26	-28	29	23	4640	4570	0.31	0.40
Lac-Mégantic	420	-27	-29	27	22	5180	4470	0.27	0.35
La Malbaie	25	-26	-28	28	21	5400	3800	0.37	0.48
La Pocatière	55	-24	-26	28	22	5160	4240	0.39	0.50
La Tuque	165	-30	-32	29	22	5500	4260	0.27	0.35
Lennoxville	155	-28	-30	29	22	4700	3790	0.25	0.32
Léry	30	-24	-26	29	23	4420	3610	0.33	0.42
Loretteville	100	-26	-29	28	22	5200	4280	0.32	0.41
Louiseville	15	-25	-28	29	23	4900	4030	0.34	0.43
Magog	215	-26	-28	29	23	4730	3880	0.27	0.35
Malartic	325	-33	-36	29	21	6200	5240	0.25	0.32
Maniwaki	180	-30	-32	29	22	5280	4350	0.24	0.31
Masson	50	-26	-28	30	23	4610	3700	0.31	0.40
Matane	5	-24	-26	24	20	5510	4580	0.43	0.55
Mont-Joli	90	-24	-26	26	21	5370	4440	0.41	0.52
Mont-Laurier	225	-29	-32	29	22	5320	4390	0.23	0.30

Table C-1 (Continued)

Province and Location	Elev., m	Design Temperature				Degree-Days Below 18°C	Degree-Days Below 15°C	Hourly Wind Pressures, kPa ⁽¹⁾	
		January		July 2.5%				1/10	1/50
		2.5% °C	1% °C	Dry °C	Wet °C				
Montmagny	10	-25	-28	28	22	5090	4170	0.37	0.47
Montréal Region									
Beaconsfield	25	-24	-26	30	23	4440	3630	0.33	0.42
Dorval	25	-24	-26	30	23	4400	3590	0.34	0.44
Laval	35	-24	-26	29	23	4500	3680	0.33	0.42
Montréal (City Hall)	20	-23	-26	30	23	4200	3410	0.34	0.44
Montréal-Est	25	-23	-26	30	23	4470	3650	0.34	0.44
Montréal-Nord	20	-24	-26	30	23	4470	3650	0.33	0.42
Outremont	105	-23	-26	30	23	4300	3500	0.34	0.44
Pierrefonds	25	-24	-26	30	23	4430	3620	0.33	0.42
Sainte-Anne-de-Bellevue	35	-24	-26	29	23	4460	3640	0.33	0.42
Saint-Lambert	15	-23	-26	30	23	4400	3590	0.34	0.44
Saint-Laurent	45	-23	-26	30	23	4270	3470	0.34	0.44
Verdun	20	-23	-26	30	23	4200	3410	0.34	0.44
Nicolet (Gentilly)	15	-25	-28	29	23	4900	3980	0.33	0.42
Nitchequon	545	-39	-41	23	19	8100	7080	0.29	0.37
Noranda	305	-33	-36	29	21	6050	5100	0.27	0.35
Percé	5	-21	-24	25	19	5400	4470	0.49	0.63
Pincourt	25	-24	-26	29	23	4480	3660	0.33	0.42
Plessisville	145	-26	-28	29	23	5100	4180	0.27	0.35
Port-Cartier	20	-28	-30	25	19	6060	5110	0.42	0.54
Puvirnituq	5	-36	-38	23	16	9200	8150	0.47	0.60
Québec City Region									
Ancienne-Lorette	35	-25	-28	28	23	5130	4210	0.32	0.41
Lévis	50	-25	-28	28	22	5050	4130	0.32	0.41
Québec	120	-25	-28	28	22	5080	4160	0.32	0.41
Sainte-Foy	115	-25	-28	28	23	5100	4180	0.32	0.41
Sillery	10	-25	-28	28	23	5070	4150	0.32	0.41
Richmond	150	-25	-27	29	22	4700	3860	0.25	0.32
Rimouski	30	-25	-27	26	20	5300	4370	0.41	0.52
Rivière-du-Loup	55	-25	-27	26	21	5380	4450	0.39	0.50
Roberval	100	-31	-33	28	21	5750	4810	0.27	0.35
Rock Island	160	-25	-27	29	23	4850	3990	0.27	0.35
Rosemère	25	-24	-26	29	23	4550	3720	0.31	0.40
Rouyn	300	-33	-36	29	21	6050	5100	0.27	0.35
Saguenay	10	-30	-32	28	22	5700	4760	0.28	0.36
Saguenay (Bagotville)	5	-31	-33	28	21	5700	4760	0.30	0.38
Saguenay (Jonquière)	135	-30	-32	28	22	5650	4710	0.27	0.35
Saguenay (Kénogami)	140	-30	-32	28	22	5650	4710	0.27	0.35

Division B

Table C-1 (Continued)

Province and Location	Elev., m	Design Temperature				Degree-Days Below 18°C	Degree-Days Below 15°C	Hourly Wind Pressures, kPa ⁽¹⁾	
		January		July 2.5%				1/10	1/50
		2.5% °C	1% °C	Dry °C	Wet °C				
Sainte-Agathe-des-Monts	360	-28	-30	28	22	5390	4470	0.27	0.35
Saint-Eustache	35	-25	-27	29	23	4500	3680	0.29	0.37
Saint-Félicien	105	-32	-34	28	22	5850	4900	0.27	0.35
Saint-Georges-de-Cacouna	35	-25	-27	26	21	5400	4470	0.39	0.50
Saint-Hubert	25	-24	-26	30	23	4490	3670	0.34	0.44
Saint-Hubert-de-Rivière-du-Loup	310	-26	-28	26	21	5520	4590	0.31	0.40
Saint-Hyacinthe	35	-24	-27	30	23	4500	3680	0.27	0.35
Saint-Jean-sur-Richelieu	35	-24	-26	29	23	4450	3630	0.32	0.41
Saint-Jérôme	95	-26	-28	29	23	4820	3960	0.29	0.37
Saint-Jovite	230	-29	-31	28	22	5250	4340	0.26	0.33
Saint-Lazare / Hudson	60	-24	-26	30	23	4520	3700	0.33	0.42
Saint-Nicolas	65	-25	-28	28	22	4990	4070	0.33	0.42
Salaberry-de-Valleyfield	50	-23	-25	29	23	4400	3590	0.33	0.42
Schefferville	550	-37	-39	24	16	8550	7520	0.33	0.42
Senneterre	310	-34	-36	29	21	6180	5220	0.25	0.32
Sept-Îles	5	-29	-31	24	18	6200	5240	0.42	0.54
Shawinigan	60	-26	-29	29	23	5050	4130	0.27	0.35
Shawville	170	-27	-30	30	23	4880	3970	0.27	0.35
Sherbrooke	185	-28	-30	29	23	4700	3790	0.25	0.32
Sorel	10	-25	-27	29	23	4550	3720	0.34	0.43
Sutton	185	-25	-27	29	23	4600	3770	0.29	0.37
Tadoussac	65	-26	-28	27	21	5450	4520	0.41	0.52
Témiscaming	240	-30	-32	30	22	5020	4100	0.25	0.32
Terrebonne	20	-25	-27	29	23	4500	3680	0.31	0.40
Thetford Mines	330	-26	-28	28	22	5120	4200	0.27	0.35
Thurso	50	-26	-28	30	23	4820	3910	0.31	0.40
Trois-Rivières	25	-25	-28	29	23	4900	3980	0.34	0.43
Val-d'Or	310	-33	-36	29	21	6180	5220	0.25	0.32
Varennes	15	-24	-26	30	23	4500	3680	0.31	0.40
Verchères	15	-24	-26	30	23	4450	3630	0.34	0.43
Victoriaville	125	-26	-28	29	23	4900	3980	0.27	0.35
Ville-Marie	200	-31	-34	30	22	5550	4610	0.31	0.40
Wakefield	120	-27	-30	30	23	4820	3910	0.27	0.34
Waterloo	205	-25	-27	29	23	4650	3810	0.27	0.35
Windsor	150	-25	-27	29	23	4700	3860	0.25	0.32
New Brunswick									
Alma	5	-21	-23	26	20	4500	3600	0.37	0.48
Bathurst	10	-23	-26	30	22	5020	4100	0.37	0.48

Table C-1 (Continued)

Province and Location	Elev., m	Design Temperature				Degree-Days Below 18°C	Degree-Days Below 15°C	Hourly Wind Pressures, kPa ⁽¹⁾	
		January		July 2.5%				1/10	1/50
		2.5% °C	1% °C	Dry °C	Wet °C				
Boiestown	65	-25	-28	29	21	4900	–	0.30	0.39
Campbellton	30	-26	-28	29	22	5500	4570	0.35	0.45
Edmundston	160	-27	-29	28	22	5320	4500	0.30	0.38
Fredericton	15	-24	-27	29	22	4670	3760	0.30	0.38
Gagetown	20	-24	-26	29	22	4460	3560	0.31	0.40
Grand Falls	115	-27	-30	28	22	5300	4450	0.30	0.38
Miramichi	5	-24	-26	30	22	4950	4030	0.32	0.41
Moncton	20	-23	-25	28	21	4680	3770	0.39	0.50
Oromocto	20	-24	-26	29	22	4650	3740	0.30	0.39
Sackville	15	-22	-24	27	21	4590	3680	0.38	0.49
Saint Andrews	35	-22	-24	25	20	4680	3770	0.35	0.45
Saint John	5	-22	-24	25	20	4570	3670	0.41	0.53
Shippagan	5	-22	-24	28	21	4930	4010	0.49	0.63
St. George	35	-21	-23	25	20	4680	3770	0.35	0.45
St. Stephen	20	-24	-26	28	22	4700	3790	0.33	0.42
Woodstock	60	-26	-29	30	22	4910	3990	0.29	0.37
Nova Scotia									
Amherst	25	-21	-24	27	21	4500	3600	0.37	0.48
Antigonish	10	-17	-20	27	21	4510	3610	0.42	0.54
Bridgewater	10	-15	-17	27	20	4140	3250	0.43	0.55
Canso	5	-13	-15	25	20	4400	3500	0.48	0.61
Debert	45	-21	-24	27	21	4500	3600	0.37	0.48
Digby	35	-15	-17	25	20	4020	3130	0.43	0.55
Greenwood (CFB)	28	-18	-20	29	22	4140	3250	0.42	0.54
Halifax Region									
Dartmouth	10	-16	-18	26	20	4100	3210	0.45	0.58
Halifax	55	-16	-18	26	20	4000	3110	0.45	0.58
Kentville	25	-18	-20	28	21	4130	3240	0.42	0.54
Liverpool	20	-16	-18	27	20	3990	3100	0.48	0.61
Lockeport	5	-14	-16	25	20	4000	3110	0.47	0.60
Louisbourg	5	-15	-17	26	20	4530	3630	0.51	0.65
Lunenburg	25	-15	-17	26	20	4140	3250	0.48	0.61
New Glasgow	30	-19	-21	27	21	4320	3420	0.43	0.55
North Sydney	20	-16	-19	27	21	4500	3600	0.46	0.59
Pictou	25	-19	-21	27	21	4310	3410	0.43	0.55
Port Hawkesbury	40	-17	-19	27	21	4500	3600	0.48	0.61
Springhill	185	-20	-23	27	21	4540	3640	0.37	0.48
Stewiacke	25	-20	-22	27	21	4400	3500	0.39	0.50
Sydney	5	-16	-19	27	21	4530	3630	0.46	0.59
Tatamagouche	25	-20	-23	27	21	4380	3480	0.43	0.55
Truro	25	-20	-22	27	21	4500	3600	0.37	0.48

Division B

Table C-1 (Continued)

Province and Location	Elev., m	Design Temperature				Degree-Days Below 18°C	Degree-Days Below 15°C	Hourly Wind Pressures, kPa ⁽¹⁾	
		January		July 2.5%				1/10	1/50
		2.5% °C	1% °C	Dry °C	Wet °C				
Wolfville	35	-19	-21	28	21	4140	3250	0.42	0.54
Yarmouth	10	-14	-16	22	19	3990	3100	0.44	0.56
Prince Edward Island									
Charlottetown	5	-20	-22	26	21	4460	3650	0.44	0.56
Souris	5	-19	-21	27	21	4550	3650	0.45	0.58
Summerside	10	-20	-22	27	21	4600	3690	0.47	0.60
Tignish	10	-20	-22	27	21	4770	3860	0.51	0.66
Newfoundland and Labrador									
Argentia	15	-12	-14	21	18	4600	3620	0.59	0.75
Bonavista	15	-14	-16	24	19	5000	4000	0.66	0.84
Buchans	255	-24	-27	27	20	5250	4240	0.47	0.60
Cape Harrison	5	-29	-31	26	16	6900	5920	0.47	0.60
Cape Race	5	-11	-13	19	18	4900	3900	0.82	1.05
Channel-Port aux Basques	5	-13	-15	19	18	5000	4000	0.61	0.78
Corner Brook	35	-16	-18	26	20	4760	3770	0.43	0.55
Gander	125	-18	-20	27	20	5110	4110	0.47	0.60
Grand Bank	5	-14	-15	20	18	4550	3570	0.58	0.74
Grand Falls	60	-26	-29	27	20	5020	4020	0.47	0.60
Happy Valley-Goose Bay	15	-31	-32	27	19	6670	5700	0.33	0.42
Labrador City	550	-36	-38	24	17	7710	6710	0.31	0.40
St. Anthony	10	-25	-27	22	18	6440	5380	0.68	0.87
Stephenville	25	-16	-18	24	19	4850	3860	0.45	0.58
St. John's	65	-15	-16	24	20	4800	3810	0.61	0.78
Twin Falls	425	-35	-37	24	17	7790	6880	0.31	0.40
Wabana	75	-15	-17	24	20	4750	3760	0.59	0.75
Wabush	550	-36	-38	24	17	7710	6710	0.31	0.40
Yukon									
Aishihik	920	-44	-46	23	15	7500	6500	0.27	0.38
Dawson	330	-50	-51	26	16	8120	7100	0.22	0.31
Destruction Bay	815	-43	-45	23	14	7800	6790	0.42	0.60
Faro	670	-46	-47	25	16	7300	6310	0.26	0.35
Haines Junction	600	-45	-47	24	14	7100	6120	0.24	0.34
Snag	595	-51	-53	23	16	8300	7280	0.22	0.31
Teslin	690	-42	-44	24	15	6770	5800	0.26	0.34
Watson Lake	685	-46	-48	26	16	7470	6470	0.26	0.35
Whitehorse	655	-41	-43	25	15	6580	5610	0.29	0.38
Northwest Territories									
Aklavik	5	-42	-44	26	17	9600	8540	0.31	0.40
Behchokò / Rae-Edzo	160	-42	-44	25	17	8300	7280	0.31	0.40
Echo Bay / Port Radium	195	-42	-44	22	16	9300	8250	0.41	0.53

Table C-1 (Continued)

Province and Location	Elev., m	Design Temperature				Degree-Days Below 18°C	Degree-Days Below 15°C	Hourly Wind Pressures, kPa ⁽¹⁾	
		January		July 2.5%				1/10	1/50
		2.5% °C	1% °C	Dry °C	Wet °C				
Fort Good Hope	100	-43	-45	28	18	8700	7660	0.34	0.44
Fort McPherson	25	-44	-46	26	17	9150	8100	0.31	0.40
Fort Providence	150	-40	-43	28	18	7620	6620	0.27	0.35
Fort Resolution	160	-40	-42	26	18	7750	6740	0.30	0.39
Fort Simpson	120	-42	-44	28	19	7660	6660	0.30	0.39
Fort Smith	205	-41	-43	28	19	7300	6310	0.30	0.39
Hay River	45	-38	-41	27	18	7550	6550	0.27	0.35
Inuvik	45	-43	-45	26	17	9600	8540	0.31	0.40
Mould Bay	5	-44	-46	11	8	12900	11730	0.45	0.58
Norman Wells	65	-43	-45	28	18	8510	7480	0.34	0.44
Tungsten	1340	-49	-51	26	16	7700	6700	0.34	0.44
Ulukhaktok / Holman	10	-39	-41	18	12	10700	9600	0.67	0.86
Wrigley	80	-42	-44	28	18	8050	7040	0.30	0.39
Yellowknife	160	-41	-44	25	17	8170	7150	0.31	0.40
Nunavut									
Alert	5	-43	-44	13	8	13030	11860	0.59	0.75
Arctic Bay	15	-42	-44	14	10	11900	10760	0.43	0.55
Arviat	5	-40	-41	22	16	9850	8780	0.45	0.58
Baker Lake	5	-42	-44	23	15	10700	9600	0.42	0.54
Eureka	5	-47	-48	12	8	13500	12310	0.43	0.55
Igluligaarjuk / Chesterfield Inlet	10	-40	-41	20	14	10500	9410	0.44	0.56
Iqaluit	45	-40	-41	17	12	9980	8900	0.51	0.65
Iqaluktuuttiaq / Cambridge Bay	15	-41	-44	18	13	11670	10540	0.39	0.50
Isachsen	10	-46	-48	12	9	13600	12410	0.47	0.60
Kangiqiniq / Rankin Inlet	10	-41	-42	21	15	10500	9410	0.47	0.60
Kanngiqtugaapik / Clyde River	5	-40	-42	14	10	11300	10180	0.43	0.55
Kugluktuk / Coppermine	10	-41	-43	23	16	10300	9210	0.36	0.46
Nottingham Island	30	-37	-39	16	13	10000	8920	0.61	0.78
Resolute	25	-42	-43	11	9	12360	11210	0.46	0.59
Resolution Island	5	-32	-34	12	10	9000	7960	0.96	1.23
Salliq / Coral Harbour	15	-41	-42	20	14	10720	9620	0.45	0.58

Notes to Table C-1:

(1) The hourly wind pressure data are used in Subclause 3.2.4.3.(2)(b)(ii).

Division C

Administrative Provisions



Division C

Part 1 General

1.1.	Application	
1.1.1.	Application	1-1
1.2.	Terms and Abbreviations	
1.2.1.	Definitions of Words and Phrases ..	1-1
1.2.2.	Symbols and Other Abbreviations ..	1-1

Division C

Part 1 General

Section 1.1. Application

1.1.1. Application

1.1.1.1. Application

1) This Part applies to all *buildings* and *building* systems covered in this Code. (See Article 1.1.1.1. of Division A.)

Section 1.2. Terms and Abbreviations

1.2.1. Definitions of Words and Phrases

1.2.1.1. Non-defined Terms

1) Words and phrases used in Division C that are not included in the list of definitions in Article 1.4.1.2. of Division A shall have the meanings that are commonly assigned to them in the context in which they are used, taking into account the specialized use of terms by the various trades and professions to which the terminology applies.

2) Where objectives and functional statements are referred to in Division C, they shall be the objectives and functional statements described in Parts 2 and 3 of Division A.

3) Where acceptable solutions are referred to in Division C, they shall be the provisions stated in Parts 3 to 8 and 10 of Division B.

4) Where alternative solutions are referred to in Division C, they shall be the alternative solutions mentioned in Clause 1.2.1.1.(1)(b) of Division A.

1.2.1.2. Defined Terms

1) The words and terms in italics in Division C shall have the meanings assigned to them in Article 1.4.1.2. of Division A.

1.2.2. Symbols and Other Abbreviations

1.2.2.1. Symbols and Other Abbreviations

1) The symbols and other abbreviations in Division C shall have the meanings assigned to them in Article 1.4.2.1. of Division A.

Division C

Part 2 Administrative Provisions

2.1.	Application	
2.1.1.	Application	2-1
2.2.	Administration	
2.2.1.	Administration	2-1
2.2.2.	Information Required for Proposed Work	2-1
2.3.	Alternative Solutions	
2.3.1.	Documentation of Alternative Solutions	2-5
	Notes to Part 2	2-7

Division C

Part 2 Administrative Provisions

Section 2.1. Application

2.1.1. Application

2.1.1.1. Application

1) This Part applies to all *buildings* and *building* systems covered in this Code. (See Article 1.1.1.1. of Division A.)

Section 2.2. Administration

2.2.1. Administration

2.2.1.1. Conformance with Administrative Requirements

1) This Code shall be administered in conformance with the appropriate federal, provincial or territorial regulations or municipal bylaws or, in the absence of such regulations or bylaws, in conformance with the Administrative Requirements for Use with the National Building Code of Canada 1985.

2) The *authority having jurisdiction* may exempt a *building* or part thereof from some or all of the requirements of this Code where it can be shown that the nature or duration of the *occupancy* makes it impractical to apply them. (See Note A-2.2.1.1.(2).)

2.2.2. Information Required for Proposed Work

2.2.2.1. General Information Required

1) Sufficient information shall be provided to show that the proposed work will conform to this Code and whether or not it will affect adjacent property. (See Note A-2.2.2.1.(1).)

2) Plans shall be drawn to scale and shall indicate the nature and extent of the work and proposed *occupancy* in sufficient detail to establish that, when completed, the work and the proposed *occupancy* will conform to this Code.

3) If proposed work is changed during construction, information on the changes shall comply with the requirements of this Section for proposed work.

2.2.2.2. Design Calculations and Analysis

1) The calculations and analysis carried out in the process of ensuring conformity with the requirements of this Code shall be available for inspection upon request.

2.2.2.3.

2.2.2.3. Documentation on the Building Envelope

1) The following documentation on the *building envelope* shall be provided for the proposed *building* and, if Section 3.3. of Division B is applied, for the reference *building* as well:

- a) gross wall area,
- b) total window area,
- c) total exterior door area,
- d) gross roof area,
- e) total *skylight* area,
- f) ratio of total *skylight* area to gross roof area,
- g) exposed floor areas,
- h) ratio of total vertical *fenestration* and door area to gross wall area,
- i) *overall thermal transmittance* of
 - i) opaque walls (above and below *grade*),
 - ii) roofs (above and below *grade*),
 - iii) floors (exposed floors and floors in contact with the ground)
 - iv) *fenestration*,
 - v) doors forming part of the *building envelope*, and
 - vi) *skylights*,
- j) description and location of *air barrier assemblies* in *opaque building assemblies*,
- k) air leakage characteristics of *fenestration* and doors that act as environmental separators,
- l) heat loss coefficient for the *building*, determined as the sum of the products of area and *overall thermal transmittance* for all above-ground *building envelope* components, and
- m) heat loss coefficient for the *building*, normalized by dividing the value from Clause (l) by the total floor area.

2.2.2.4. Documentation on Lighting Systems

- 1) The following documentation on the lighting systems shall be provided:
- a) an as-built single-line diagram of the lighting control system showing the location of each illuminated zone and associated switches and controls,
 - b) *installed interior lighting power in conditioned spaces*, in kW,
 - c) average lighting power density, in W/m², obtained by dividing the *installed interior lighting power* by the total floor area,
 - d) if the *building area method* is used to determine the *interior lighting power allowance*, the associated lighting power density, in W/m², and the *gross lighted area*, in m²,
 - e) if the *space-by-space method* is used to determine the *interior lighting power allowance*, a detailed line-by-line breakdown of spaces, their floor area, in m², the associated lighting power densities, in W/m², and the resulting lighting power allowances, in kW,
 - f) *interior lighting power allowance*, in kW,
 - g) installed interior automatic controls and justification for spaces exempted,
 - h) *exterior lighting power*, in kW, including a detailed line-by-line breakdown of spaces and/or functions, and
 - i) installed exterior automatic controls and justification for spaces and/or functions exempted.

2.2.2.5. Documentation on HVAC Systems

- 1) The following documentation on the HVAC system shall be provided:
- a) a description of each system, detailing its function, design details, performance characteristics and distribution arrangement,
 - b) schematic and control diagrams and sequence of operation, and
 - c) start/stop and adjustment procedures.

2.2.2.6. Documentation on Service Water Systems

- 1) The following documentation on the *service water* system shall be provided:
 - a) a description of each system detailing its function, design details, performance characteristics and distribution arrangement,
 - b) schematic and control diagrams and sequence of operation, and
 - c) start/stop and adjustment procedures.

2.2.2.7. Documentation on Electrical Power Systems and Motors

- 1) The following documentation on the electrical power systems and motors shall be provided:
 - a) an as-built single-line diagram of the *building's* electrical distribution system indicating the locations of means to monitor energy consumption,
 - b) schematic diagrams of electrical control systems for systems other than heating, ventilating and air-conditioning, *service water* heating, and lighting, and
 - c) the manufacturers' operational manuals for all electrical equipment.

2.2.2.8. Documentation Requirements for Building Performance Compliance

1) If Part 8 of Division B is used to demonstrate compliance with Parts 3 to 7 of Division B, a *building* performance compliance calculation report shall be produced in accordance with this Article in addition to the documentation required by Articles 2.2.2.3. to 2.2.2.7.

2) The header of each page of the *building* performance compliance calculation report shall contain the following information:

- a) project name,
- b) date of analysis,
- c) unique run number to identify all report pages as being the result of that analysis run,
- d) report title, and
- e) page number (consecutive within each report).

3) The following information shall be included in the *building* performance compliance calculation report:

- a) the project information section of the report shall contain:
 - i) project name or identifier,
 - ii) project description,
 - iii) project address,
 - iv) geographic region in which proposed design is to be built,
 - v) identifier for climate data set used for analysis, and
 - vi) floor area of *conditioned spaces* of the proposed design,
- b) the *building envelope* data summary section of the report shall contain the documentation required in Article 2.2.2.3. for both the proposed *building* and the reference *building*,
- c) the lighting systems data summary section of the report shall contain the following data for both the proposed *building* and the reference *building*:
 - i) *installed interior lighting power* in *conditioned spaces*, in kW,
 - ii) average installed lighting power density, in W/m², obtained by dividing the *installed interior lighting power* by the total floor area,
 - iii) *interior lighting power allowance*, in kW,
 - iv) average lighting power allowance density, in W/m², obtained by dividing the *interior lighting power allowance* by the total floor area,
 - v) *exterior lighting power*, and
 - vi) if daylighting calculations are performed, the method of calculation and the results,
- d) the HVAC data summary section of the report shall contain the following data for both the proposed *building* and the reference *building*:
 - i) total heating capacity, by energy source used for heating,
 - ii) total cooling capacity, by energy source used for cooling,

- iii) total supply airflow, in L/s,
 - iv) total supply fan power at design, in kW,
 - v) total return fan power at design, in kW,
 - vi) sum of supply fan power plus return fan power divided by total supply airflow, in W per L/s,
 - vii) type of HVAC system, and
 - viii) the design basis for the ventilation rates,
- e) the *service water* heating data summary section of the report shall contain the following data:
- i) whether or not the *service water* heating systems of the proposed *building* have been taken into account in the simulation, and
 - ii) if *service water* heating systems are part of the *building* performance calculation, the total heating capacity for both the proposed *building* and the reference *building*, and
- f) the energy performance data summary section of the report shall contain the results of the following *building* performance calculations:
- i) the amount of each energy source used by the proposed *building*, in MJ,
 - ii) the amount of each energy source used by the reference *building*, in MJ,
 - iii) the *annual energy consumption* of the proposed *building* (sum of all energy sources), in MJ,
 - iv) the *building energy target* of the reference *building* (sum of all energy sources), in MJ, and
 - v) a breakdown of energy usage, per energy source, for the following *building* components and systems: space-heating equipment, space-cooling equipment, *interior lighting*, *service water* heating equipment, elevators and escalators, fans, pumps and other HVAC equipment, miscellaneous equipment and receptacle power equipment.
- 4)** The report shall identify which *building* characteristics fail to meet, which ones meet, and which ones exceed the performance levels of the prescriptive requirements of Parts 3 to 7 of Division B.
- 5)** If the energy usage of the proposed *building* is no greater than the energy usage of the reference *building*, the report shall state that the proposed *building* satisfies the *building energy target* calculation requirements and complies with the Code, exclusive of verification of the limitations contained in Parts 3 to 7 of Division B.
- 6)** The report shall contain a certification section stating that
- a) the analysis was performed in accordance with Part 8 of Division B of the NECB,
 - b) the input for the analysis is a true representation of the proposed *building* submitted for approval, and
 - c) all other requirements of Part 8 of Division B have been satisfied.
- 7)** The report shall contain a complete list of all the inputs on which the compliance analysis for both the proposed *building* and reference *building* is based.
- 8)** The report shall contain a list of system data that were excluded for both the reference *building* and the proposed *building*, citing one of the following reasons:
- a) system was excluded because it complies with the prescriptive requirements of the Code and has no effect on other *building* components, or
 - b) system was excluded because of an exemption permitted by the Code.
- 9)** The report shall contain a description of any adaptations made to the compliance calculations, if applicable.

Section 2.3. Alternative Solutions

2.3.1. Documentation of Alternative Solutions

(See Note A-2.3.1.)

2.3.1.1. Documentation

- 1)** Documentation conforming to this Subsection shall be provided by the person requesting the use of an alternative solution to demonstrate that the proposed alternative solution complies with this Code.
- 2)** The documentation referred to in Sentence (1) shall include
 - a) a Code analysis outlining the analytical methods and rationales used to determine that a proposed alternative solution will achieve at least the level of performance required by Clause 1.2.1.1.(1)(b) of Division A, and
 - b) information concerning any special maintenance or operational requirements, including any *building* component commissioning requirements, that are necessary for the alternative solution to achieve compliance with the Code after the *building* is constructed.
- 3)** The Code analysis referred to in Clause (2)(a) shall identify the objective, functional statements and acceptable solutions, and any assumptions, limiting or restricting factors, testing procedures, engineering studies or *building* performance parameters that will support a Code compliance assessment.
- 4)** The Code analysis referred to in Clause (2)(a) shall include information about the qualifications, experience and background of the person or persons taking responsibility for the design.
- 5)** The information provided under Sentence (3) shall be in sufficient detail to convey the design intent and to support the validity, accuracy, relevance and precision of the Code analysis.
- 6)** Where the design of a *building* includes proposed alternative solutions that involve more than one person taking responsibility for different aspects of the design, the applicant for the permit shall identify a single person to co-ordinate the preparation of the design, Code analysis and documentation referred to in this Subsection.

Notes to Part 2

Administrative Provisions

A-2.2.1.1.(2) Exemptions Due to Special Occupancy Requirements. The intended use or nature of the occupancy of some buildings may be such that compliance with certain Code requirements could limit or prevent these buildings from performing their intended function.

Sentence 2.2.1.1.(2) permits the authority having jurisdiction to review such special cases and to permit deviations. Only the nature of the occupancy, rather than economic or other factors, should be considered in permitting such deviations.

As it would be difficult and onerous to include every single potential exemption in this Code, Sentence 2.2.1.1.(2) addresses unforeseen circumstances with a general statement. The following lists of possible exemptions to requirements in Parts 3, 4 and 5 of Division B are not exhaustive.

Examples of buildings that could be exempted from complying with some Part 3 requirements:

- horticultural, silvicultural and botanical greenhouses, and greenhouses used for research could be exempted from the requirements related to fenestration performance and area,
- buildings in which permanent processes continuously produce enough heat such that no other heating source is required could have their insulation requirements reduced to the extent that the processes can still provide all of the required heating,
- industrial buildings where processes impose large ventilation requirements could be exempted from airtightness requirements,
- buildings in which only sufficient radiant heating is provided to improve conditions locally for the occupants without temperature control of the ambient air, such as bus shelters or bleacher areas in some ice arenas.

Examples of buildings that could be exempted from complying with some Part 4 requirements:

- The application of the lighting requirements in Part 4 may adversely affect the use of spaces with special functional requirements; as such, some exceptions to these requirements may be necessary. Except for particular types of process lighting, however, it is unlikely that a space or lighting system would be exempt from all the requirements in Part 4. Some necessary exceptions to particular requirements are identified in the Code. Exemption should be determined on a case-by-case basis, taking into consideration the space's function, available technologies and cost-effectiveness.

Example of buildings that could be exempted from complying with some Part 5 requirements:

- buildings or rooms in which the processes or activities call for temperature or humidity conditions outside the normal range required for comfort.

A-2.2.2.1.(1) General Information Required. The information documenting the conformity of a building to this Code must describe the essential characteristics of the building and its systems. To this end, the authority having jurisdiction may require access to the following information:

- floor plan of the building giving the floor area of conditioned spaces and gross lighted area of each storey,
- elevations of all the building's faces, giving finished floor and ground levels,
- typical cross-sections of foundations, exterior walls, roofs, ceilings and floors that separate conditioned space from unconditioned space or the exterior, describing their construction and giving the thermal resistance of each material and the overall thermal transmittance of each assembly of the building,
- indoor design temperatures for all spaces,
- required vestibules,

These Notes are included for explanatory purposes only and do not form part of the requirements. The number that introduces each Note corresponds to the applicable requirement in this Part.

A-2.3.1.

- descriptions of the different types of air barrier assemblies and their location,
- window dimensions,
- characteristics of fenestration, sliding glass doors and other doors separating conditioned space from unconditioned space or the exterior (e.g. overall thermal transmittance and air leakage control),
- required report on trade-offs, if applicable,
- details of required exterior lighting controls and exterior lighting power for exits, entrances and facades,
- details of required interior lighting controls and interior lighting power,
- identification of static pressure class and leakage class of ducts,
- thermal insulation of pipes and air ducts,
- location of required dampers and of thermostatic controls and cut-offs,
- location and extent of the airflow control areas and temperature-control zones,
- efficiency of unitary and packaged heating and cooling equipment,
- power requirements for the operation of heating, ventilating and cooling systems, with air volumes, and the type of control used for ventilation,
- types and capacities of and controls for the heating and cooling systems, including cooling with exterior air,
- details of pumping systems with variable flow,
- characteristics of heat-recovery ventilators, where required,
- efficiency of service water heating equipment,
- service water distribution layouts and controls,
- required report on performance compliance, if applicable,
- basis for ventilation design and justification for any variance from good practice, where applicable.

A-2.3.1. Documentation of Alternative Solutions. Beyond the purposes of demonstrating compliance and acquiring a building permit, there are other important reasons for requiring that the proponent of an alternative solution submit project documentation (i.e. a compliance report) to the authority having jurisdiction and for the authority having jurisdiction to retain that documentation for a substantial period following the construction of a building:

- Most jurisdictions require that a building be maintained in compliance with the codes under which it was built. Alternative solutions made possible by objective-based codes may have special maintenance requirements, which would be described in the documentation.
- Documentation helps consultants perform code compliance assessments of existing buildings before they are sold and informs current owners or prospective buyers of existing buildings of any limitations pertaining to their future use or development.
- Documentation provides design professionals with the basic information necessary to design changes to an existing building.
- An alternative solution could be invalidated by a proposed alteration to a building. Designers and regulators must therefore know the details of the particular alternative solutions that were integral to the original design. Complete documentation should provide insight as to why one alternative solution was chosen over another.
- Documentation is the “paper trail” of the alternative solution negotiated between the designer and the regulator and should demonstrate that a rational process led to the acceptance of the alternative solution as an equivalency.
- It is possible that over time a particular alternative solution may be shown to be inadequate. It would be advantageous for a jurisdiction to know which buildings included that alternative solution as part of their design: documentation will facilitate this type of analysis.
- Project documentation provides important information to a forensic team that is called to investigate an accident or why a design failed to provide the level of performance expected.

This subject is discussed in further detail in “Recommended Documentation Requirements for Projects Using Alternative Solutions in the Context of Objective-Based Codes,” which was prepared for the CCBFC Task Group on Implementation of Objective-Based Codes and is available on the CBHCC's website.

Index

A

Abbreviations

- proper names, 1.3.2.1., 1.5.2.1.[A]
- symbols and other abbreviations, 1.4.2.1.[A]

Above-ground components of the building envelope

- areas of, for performance path calculations, 8.4.2.8.
- areas of, for trade-off path calculations, 3.3.1.2.
- prescriptive path, 3.2.2.

Acceptable solutions

- application of Code, 1.2.1.1.[A]
- building energy performance compliance path, 8.5.1.1.
- building envelope, 3.5.1.1.
- electrical power systems and motors, 7.5.1.1.
- HVAC systems, 5.5.1.1.
- lighting, 4.5.1.1.
- service water systems, 6.5.1.1.

Access hatches, 3.2.2.4.

Additions

- application of Code, 1.1.1.1.[A]
- building energy performance path compliance, 8.4.1.4.
- calculation of fenestration and door areas, 3.1.1.6.
- definition, 1.4.1.2.[A]
- functional statements and objectives, 8.5.1.1.
- HVAC systems, limitations of Code application, 5.1.1.2.
- trade-off path, limitations of application, 3.3.1.1.

Administration of the Code, 2.2.[C]

Air barrier assemblies, 1.4.1.2.[A], 2.2.2.3.[C], 3.2.4.1. - 3.2.4.3.

Air barrier systems, 1.4.1.2.[A], 2.2.2.3.[C], 3.2.4.1., 3.2.4.2.

Air conditioners, unitary and packaged, 5.2.12.1.

Air-conditioning systems (see Heating, ventilating and air-conditioning (HVAC) systems)

Air contaminants, 5.2.3.4.

Air distribution systems, 5.2.2., 5.2.11.2., 8.4.4.7., 8.4.4.18.

Air economizer systems, 5.2.2.8.

Airflow control areas, 1.4.1.2.[A], 5.2.11.2.

Air intakes, 5.2.2.8., 5.2.4., 5.2.11.1.

Air leakage

- building envelope design, 3.2.1.1.
- documentation requirements, 2.2.2.3.[C]
- doors, 3.2.4.3.

ducts, 5.2.2.4.

fenestration, 3.2.4.3.

fireplace doors, 3.2.4.3.

loading docks, 3.2.4.3.

performance compliance, 8.4.2.9., 8.4.3.3., 8.4.4.3.

prescriptive path, 3.2.4.1.

windows, 3.2.4.3.

Alternative solutions

- compliance with Code, 1.2.1.1.[A]
- documentation, 2.3.1.[C]

Analysis and design calculations, 2.2.2.2.[C]

Annual energy consumption

- building energy performance calculations, 8.4.2.2.
- definition, 1.4.1.2.[A]
- documentation, 2.2.2.8.[C]
- lighting, 4.3.1.3., 4.3.2.1., 4.3.3.1.
- performance path, 8.4.1.1., 8.4.1.2., 8.4.3.

Appliances

- characteristics, 1.2.2.1.[A]
- storage on building site, 1.2.2.2.[A]
- used, 1.2.2.3.[A]

Application of the Code

- all Divisions, 1.1.1.[A], 1.1.1.1.
- Division A, 1.3.2.[A]
- Division B, 1.1.1.1., 1.3.3.[A]
- Division C, 1.3.4.[A]

Areas

- above-ground assemblies, 3.3.1.2., 8.4.2.8.
- doors, 3.1.1.6.
- fenestration, 3.1.1.6.
- gross wall, 3.1.1.6.

Arenas

- factors for occupancy control and personal control, 4.3.2.10.
- heat recovery from ice-making machines, 5.2.10.3., 8.4.3.9.
- HVAC system selection, 8.4.4.7.
- lighting power density, 4.2.1.5., 4.2.1.6.

Assembly occupancy

- definition, 1.4.1.2.[A]
- HVAC system selection, 8.4.4.7.

Atriums, 4.2.1.6., 4.3.2.10.

Authority having jurisdiction

- climatic values, 1.1.4.1.
- Code exemptions, 2.2.1.1.[C]
- definition, 1.4.1.2.[A]
- exterior lighting allowances, 4.2.3.1.
- leakage testing of ducts, 5.2.2.4.

[A] – Reference occurs in Division A. [C] – Reference occurs in Division C. All other references occur in Division B.

Automotive facilities

- HVAC system selection, 8.4.4.7.
- lighting power density, 4.2.1.5.

B

Balancing

- air distribution systems, 5.2.2.2.
- hydronic systems, 5.2.5.2.

Ballasts, 4.2.1.2., 4.2.1.4.

Banking activities

- factors for occupancy control and personal control, 4.3.2.10.
- HVAC system selection, 8.4.4.7.
- lighting power density, 4.2.1.6.

Baseboard heaters, 3.1.1.2., 8.4.4.7.

Bathrooms

- (see also Lavatories)
- fans/fan systems, 5.2.3.1.
- hot service water, 6.2.6.1., 6.2.6.2.
- lighting controls, 4.2.2.6.

Boilers

- definition, 1.4.1.2.[A]
- efficiency requirements, 5.2.12.1.
- multiple, 5.2.11.4.
- part-load performance, 8.4.5.2.
- performance path, 8.4.3.5., 8.4.4.6., 8.4.4.7., 8.4.4.9., 8.4.4.20.
- variable-flow pumping systems, 5.2.6.2.

Booster heaters, service water, 6.2.5.1.

Branch circuit conductors, 7.2.2.2.

Building, 1.4.1.2.[A]

Building additions (see Additions)

Building energy performance compliance path

- additions, 8.4.1.4.
- air leakage, 8.4.2.9., 8.4.3.3., 8.4.4.3.
- building envelope, 3.4., 8.4.2.8., 8.4.3.3., 8.4.4.3., 8.4.4.4.
- calculation methods, 8.4.2.2.
- climatic data, 1.1.4.1., 8.4.2.3., 8.4.2.10., 8.4.4.1.
- compliance, 8.4.1.2.
- cooling systems, 8.4.4.10., 8.4.4.11.
- documentation, 2.2.2.8.[C]
- electrical power systems and motors, 7.4.
- equipment oversizing, 8.4.4.8.
- heat recovery, 8.4.4.19.
- heat transfer between thermal blocks, 8.4.2.6.
- heating systems, 8.4.4.9.
- HVAC systems, 5.4., 8.4.1.2., 8.4.2.10., 8.4.3.1., 8.4.4.7., 8.4.4.12., 8.4.4.13., 8.4.4.17., 8.4.4.18., 8.4.4.19.
- hydronic pumps, 8.4.4.14.
- ice plants, 8.4.3.9.
- internal loads, 8.4.3.2., 8.4.4.2.
- lighting, 4.3.1.3., 8.4.1.1., 8.4.3.1., 8.4.3.2., 8.4.3.4., 8.4.4.5.
- limitations of compliance, 5.4.1.2., 6.4.1.2., 8.4.1.3.
- operating schedules, 8.4.2.2., 8.4.3.2., 8.4.4.2.
- outdoor air, 8.4.3.6., 8.4.4.15.
- part-load performance, 8.4.3.8., 8.4.5.

proposed building, 8.4.3.

purchased energy, 8.4.3.5., 8.4.4.6.

reference building, 8.4.4.

scope, 8.1.1.1.

- service water heating, 6.4., 8.4.2.7., 8.4.3.1., 8.4.3.2., 8.4.3.5., 8.4.4.2., 8.4.4.6., 8.4.4.19., 8.4.4.20.
- space temperatures, 8.4.2.5., 8.4.3.7., 8.4.4.16.
- system selection, 8.4.4.7.
- thermal mass, 8.4.2.4., 8.4.4.4.

Building energy target

- additions, 8.4.1.4.
- definition, 1.4.1.2.[A]
- determination of compliance, 8.4.1.2.
- establishing, 8.4.1.1.
- reference building, 8.4.4.

Building envelope

- above-ground components, 3.2.2.
- air leakage, 3.2.4.
- application of Code, 3.1.1.2.
- compliance, 3.1.1.3.
- definition, 1.4.1.2.[A]
- documentation, 2.2.2.3.[C]
- fenestration and door areas, 3.1.1.6., 3.2.1.4.
- heat losses or gains, 5.2.8.6.
- insulation, 3.2.1.1., 3.2.1.2.
- overall thermal transmittance (see Overall thermal transmittance)
- performance path, 3.4., 8.4.2.8., 8.4.3.3., 8.4.4.3., 8.4.4.4.
- spaces heated to different temperatures, 3.2.1.3.
- thermal characteristics, 3.1.1.5., 3.2.2.2., 3.2.2.3., 3.2.2.4., 3.2.3., 8.4.2.4., 8.4.4.4.
- trade-off path, 3.3.1.
- vestibules, 3.2.2.1.

Building height, 1.4.1.2.[A]

Building materials

- characteristics, 1.2.2.1.[A]
- storage on building site, 1.2.2.2.[A]
- used, 1.2.2.3.[A]

Building regulations, other, 1.1.1.3.[A]

Building types

- HVAC system selection, 8.4.4.7.
- lighting power allowance calculations, 4.2.1.5.
- service water heating load calculations, 8.4.2.7.

C

Calculations

- design calculations and analysis, 2.2.2.2.[C]
- FDWR, 3.1.1.6., 8.4.4.3.
- load (see Load calculations)
- overall thermal transmittance, 3.1.1.7.
- percent building energy target, 10.1.2.1.
- percent improvement, 10.1.2.1.
- performance (see Building energy performance compliance path)
- procedures, 1.1.4.2.
- skylight area allowable, 3.1.1.6.
- thermal characteristics of building assemblies, 3.1.1.5.

- Ceiling height, 1.4.1.2.[A]
- Chillers
 cooling HVAC systems, 8.4.4.7.
 cooling hydronic systems, 8.4.4.10.
 efficiency requirements, 5.2.12.1.
 heat-recovery capacity, 8.4.4.19.
 ice plants as, 8.4.3.9.
 loop temperature reset, 5.2.11.5.
 part-load performance characteristics, 8.4.5.5.
 performance path calculations, 8.4.3.5., 8.4.4.6.
 variable-flow pumping systems, 5.2.6.2.
- Classrooms
 factors for occupancy control and personal control, 4.3.2.10.
 HVAC system selection, 8.4.4.7.
 lighting controls, 4.2.2.1.
 lighting power density, 4.2.1.6.
- Climatic data/values
 data and calculation methods, 1.1.4.1.
 documentation requirements, 2.2.2.8.[C]
 performance calculations, 8.4.2.3.
 used in performance calculations, 8.4.2.10., 8.4.4.1.
- Climatic zones
 above-ground components of building envelope, 3.2.2.
 building assemblies in contact with ground, 3.2.3.
 performance path compliance, 8.4.1.1.
- Coefficient of performance
 definition, 1.4.1.2.[A]
 values, 8.4.4.14., 8.4.4.17., 8.4.5.
- Combustion efficiency, 1.4.1.2.[A]
- Compliance
 achieving, 1.2.1.1.[A]
 alternative solutions, 1.2.1.1.[A]
 attributions to acceptable solutions, 1.1.3.1.
 building envelope, 3.1.1.3., 3.5.1.1.
 calculation procedures, 1.1.4.2.
 electrical power systems and motors, 7.1.1.3., 7.5.1.1.
 HVAC systems, 5.1.1.3., 5.5.1.1.
 lighting, 4.1.1.3., 4.3.1.3., 4.5.1.1.
 performance path (see also Building energy performance compliance path), 8.1.1.1., 8.4.1., 8.4.1.2.
 prescriptive (see Prescriptive compliance) requirements, 1.1.2.1.
 service water systems, 6.1.1.3., 6.5.1.1.
 tiered building energy performance, 10.1.2.
- Computer/server rooms
 air conditioners, 5.2.12.1.
 factors for occupancy control and personal control, 4.3.2.10.
 HVAC system selection, 8.4.4.7.
 lighting power density, 4.2.1.6.
- Condensing units, 5.2.12.1.
- Conditioned spaces
 airflow control, 5.2.11.2.
 definition, 1.4.1.2.[A]
 ducts/dampers, 5.2.2.3., 5.2.2.5., 5.2.4.1.
 energy performance modeling, 8.4.4.1., 8.4.4.7.
 fan systems, 5.2.3.1., 5.2.3.2., 5.2.3.3., 5.2.3.4.
 insulation of piping in, 5.2.5.3., 6.2.3.1.
 pumping system design, 5.2.6.1.
 spaces heated to different temperatures, 3.2.1.3.
 swimming pools, 5.2.10.2.
 vestibules, 5.2.8.6.
- Conference rooms
 HVAC system selection, 8.4.4.7.
 lighting power density, 4.2.1.6.
- Confinement cells
 factors for occupancy control and personal control, 4.3.2.10.
 HVAC system selection, 8.4.4.7.
 lighting power density, 4.2.1.6.
- Conflicting requirements, 1.1.1.3.[A], 1.5.1.2.[A]
- Constant-volume fan systems, 5.2.3.2.
- Controls
 boilers, 5.2.11.4.
 fan systems, 5.2.2.3., 5.2.3.3.
 heat pumps, 5.2.8.5., 5.2.11.1.
 humidification, 5.2.9.1.
 HVAC systems, 5.2.2.7., 5.2.2.8., 5.2.6.2., 5.2.8.8., 5.2.11.2., 5.2.11.5.
 lighting (see Lighting controls)
 performance, 8.4.3.1.
 pressure booster systems, 6.2.8.2.
 reheating and recooling, 5.2.8.9.
 service water heating systems, 6.2.4.
 shut-off and setback, 5.2.11.
 smoke, 5.1.1.2., 5.2.10.1., 8.4.4.17.
 snow/ice-melting heaters, 5.2.8.7.
 space temperature, 5.2.8.1., 5.2.8.6., 5.2.8.9., 8.4.3.7., 8.4.4.16.
 swimming pools, 6.2.7.1.
 temperature (see Temperature controls)
- Convention centres, 4.2.1.5., 4.2.1.6., 4.3.2.10.
- Cooling
 (see also Heating, ventilating and air-conditioning (HVAC) systems)
 with outdoor air, 5.2.2.7., 5.2.2.8., 5.2.2.9., 8.4.4.12.
- Cooling tower systems, 8.4.4.11., 8.4.5.6.
- Copy/print rooms, 4.2.1.6., 4.3.2.10.
- Corridors, 4.2.1.6., 4.3.2.10.
- Courthouses/courtrooms
 factors for occupancy control and personal control, 4.3.2.10.
 HVAC system selection, 8.4.4.7.
 lighting power density, 4.2.1.5., 4.2.1.6.
- Curling rinks, 5.2.10.3., 8.4.4.7.

D

- Dampers
 location and type, 5.2.4.2.
 motorized, 5.2.4.2.
 required, 5.2.4.1.
- Daylighting
 determination of daylighted area, 4.3.2.3., 4.3.3.3.
 determination of non-daylighted area, 4.3.2.4., 4.3.3.4.

- determination of operational times, 4.3.2.5., 4.3.2.6., 4.3.3.5., 4.3.3.6.
 - harvesting factor, 4.3.2.7., 4.3.3.7.
 - performance path calculations, 8.4.3.4., 8.4.4.5.
 - supply factor for sidelighting, 4.3.2.8.
 - supply factor for toplighting, 4.3.2.9.
 - under roof monitors, 4.2.2.4.
 - under skylights, 4.2.2.5.
 - Definitions
 - not included in Code, 1.4.1.1.[A]
 - words and phrases used in Code, 1.4.1.2.[A]
 - Dehumidification, swimming pools, 5.2.10.2.
 - Demand control ventilation systems, 5.2.3.4.
 - Design calculations, 2.2.2.2.[C]
 - Dining areas/facilities
 - factors for occupancy control and personal control, 4.3.2.10.
 - HVAC system selection, 8.4.4.7.
 - lighting power density, 4.2.1.5., 4.2.1.6.
 - Direct-expansion systems, piping
 - cooling with outdoor air, 5.2.2.8.
 - efficiency of ground-source heat pumps, 5.2.12.1.
 - HVAC systems with, 8.4.4.7.
 - modeled in reference building, 8.4.4.10.
 - part-load performance characteristics, 8.4.5.
 - suction-line insulation, 5.2.5.3.
 - Documentation
 - alternative solutions, 2.3.1.1.[C]
 - building envelope, 2.2.2.3.[C]
 - building performance compliance, 2.2.2.8.[C]
 - electrical power systems and motors, 2.2.2.7.[C]
 - HVAC systems, 2.2.2.5.[C]
 - information required, 2.2.2.[C]
 - lighting systems, 2.2.2.4.[C]
 - service water systems, 2.2.2.6.[C]
 - Documents, referenced, 1.3.1., 1.5.1.[A]
 - Doors
 - (see also Fenestration)
 - air leakage, 3.2.4.3.
 - allowable area of, 3.1.1.6., 3.2.1.4.
 - documentation, 2.2.2.3.[C]
 - exterior, for vestibules, 3.2.2.1.
 - overall thermal transmittance, 3.2.2.4.
 - trade-off path, 3.3.1.1.
 - Dormitories
 - factors for occupancy control and personal control, 4.3.2.10.
 - HVAC system selection, 8.4.4.7.
 - lighting power density, 4.2.1.5., 4.2.1.6.
 - Ducts
 - design and installation, 5.2.2.1., 5.2.2.2., 5.2.2.3.
 - exhaust, 1.4.1.2.[A], 5.2.2.5.
 - heating in floors, 3.2.3.3.
 - insulation, 3.2.1.2., 5.2.2.5., 5.2.2.6., 5.2.4.2.
 - leakage testing, 5.2.2.4.
 - required dampers, 5.2.4.1.
 - return, 1.4.1.2.[A], 5.2.2.3., 5.2.2.5.
 - sealing, 5.2.2.3.
 - supply, 1.4.1.2.[A], 5.2.2.6.
 - Dwelling units
 - cooling, 5.2.2.7.
 - definition, 1.4.1.2.[A]
 - ducts, 5.2.2.5.
 - exterior doors from, 3.2.2.1.
 - heat recovery, 5.2.10.4.
 - HVAC systems (see Heating, ventilating and air-conditioning (HVAC) systems)
 - interior lighting, 4.1.1.2., 8.4.3.4., 8.4.4.5.
 - monitoring of energy consumption, 7.2.1.1.
 - off-hours controls, 5.2.11.1.
 - piping insulation, 5.2.3.2.
 - temperature controls, 5.2.8.1., 5.2.8.2.
- ## E
- Electric heating systems, 6.2.3.1.
 - Electric-resistance heating, 5.2.8.6., 5.2.12.1., 8.4.4.7.
 - Electrical power
 - additions, 8.4.1.4.
 - application of Code, 7.1.1.2.
 - compliance, 7.1.1.3.
 - documentation, 2.2.2.7.[C]
 - electrical distribution system, 7.2.1.
 - exit signs, 4.2.1.1.
 - exterior lighting, 7.2.1.1.
 - fans, 5.2.3.1., 5.2.3.2., 5.2.3.3.
 - HVAC systems, 7.2.1.1.
 - interior lighting, 7.2.1.1.
 - monitoring, 7.2.1.1.
 - motors, 7.2.4.
 - pump motors, 5.2.6.3.
 - transformers, 7.2.3.
 - voltage drop, 7.2.2.
 - Elevator motors, 7.2.4., 8.4.2.2.
 - Emergency exits, 3.2.2.1.
 - Emergency lighting, 4.1.1.2.
 - Emergency vehicle garages, 4.2.1.6., 4.3.2.10.
 - Enclosed spaces, 1.4.1.2.[A]
 - Energy-efficiency ratio, 1.4.1.2.[A]
 - Energy factor, 1.4.1.2.[A]
 - Energy performance tier, 10.1.2.1.
 - Entrances, exterior, 1.4.1.2.[A], 4.2.3.1., 4.2.4.1.
 - Equipment
 - characteristics, 1.2.2.1.[A]
 - efficiency, 5.2.12.1., 6.2.2.1.
 - field-assembled, 5.2.12.3.
 - heat rejection, 5.2.12.2.
 - outdoors, 5.2.7.1.
 - packaged, 5.2.12.1., 8.4.4.7.
 - service water heating, 5.2.12.4., 6.2.2.1., 6.2.2.2., 6.2.2.3., 6.2.2.4.
 - sizing, 5.2.1., 8.4.3.5., 8.4.4.8.
 - storage on building site, 1.2.2.2.[A]
 - unitary, 5.2.12.1.
 - used, 1.2.2.3.[A]
 - Exercise centres, 4.2.1.5., 4.2.1.6., 4.3.2.10.
 - Exhaust ducts
 - definition, 1.4.1.2.[A]
 - insulation, 5.2.2.5.
 - Exits
 - definition, 1.4.1.2.[A]

emergency, 3.2.2.1.
 exterior, 1.4.1.2.[A], 4.2.3.1., 4.2.4.1.
 signs, 4.2.1.1.
 Exterior entrances, 1.4.1.2.[A], 4.2.3.1., 4.2.4.1.
 Exterior exits, 1.4.1.2.[A], 4.2.3.1., 4.2.4.1.
 Exterior lighting
 allowances, 4.2.3.1.
 controls, 4.2.4.1.
 definition, 1.4.1.2.[A]
 monitoring, 7.2.1.1.
 performance path calculations, 8.4.1.1.
 power, 4.2.3.

F

Facade lighting, 1.4.1.2.[A], 4.2.3.1.
 Fans/fan systems
 application of Code, 5.2.3.1.
 constant-volume, 5.2.3.2.
 demand control ventilation, 5.2.3.4.
 design, 5.2.3.
 heat rejection equipment, 5.2.12.2.
 off-hours controls, 5.2.11.1.
 performance compliance, 8.4.2.2., 8.4.2.10., 8.4.4.7.,
 8.4.4.11., 8.4.4.17., 8.4.4.18.
 power demand, 5.2.3.1., 5.2.3.3., 5.2.11.2.
 variable-air-volume, 5.2.3.3., 5.2.11.2.
 Farm buildings
 Code not applicable to, 1.1.1.1.[A]
 definition, 1.4.1.2.[A]
 Faucets, 6.2.6.2.
 Feeder conductors, 7.2.2.1.
 Fenestration
 (see also Doors; Windows)
 air leakage, 3.2.4.3.
 allowable area of, 3.1.1.6., 3.2.1.4.
 definition, 1.4.1.2.[A]
 documentation, 2.2.2.3.[C]
 effective luminous transmittance, 4.3.2.8.
 overall thermal transmittance, 3.1.1.5., 3.2.2.3.
 performance path calculations, 8.4.2.8., 8.4.3.1.,
 8.4.4.3.
 thermal characteristics, 3.2.2.3.
 trade-off path, 3.3.1.1.
 Fenestration and door area to gross wall area ratio
 (FDWR)
 calculation of, 3.1.1.6.
 maximum allowable, 3.2.1.4.
 performance compliance, 8.4.4.3.
 trade-off, simple, 3.3.1.1.
 Fire stations
 factors for occupancy control and personal control,
 4.3.2.10.
 lighting power density, 4.2.1.5., 4.2.1.6.
 Fireplace doors, 3.2.4.3.
 Firewalls, 1.4.1.2.[A]
 Floor surface area, 1.4.1.2.[A]
 Floors/floor assemblies
 above-ground, 3.2.2.2.
 documentation, 2.2.2.3.[C]

in contact with ground, 3.2.3.3.
 overall thermal transmittance, calculation of,
 3.1.1.7.
 performance path calculations, 8.4.2.8.
 thermal characteristics, 3.2.2.2., 3.2.3.3.
 trade-off path, 3.3.
 Fluorescent lamp ballasts, 4.2.1.2., 4.2.1.4.
 Food preparation areas
 factors for occupancy control and personal control,
 4.3.2.10.
 HVAC system selection, 8.4.4.7.
 lighting power density, 4.2.1.6.
 Foundations
 definition, 1.4.1.2.[A]
 thermal characteristics, 3.2.2.2., 3.2.3.3.
 Frames, 1.4.1.2.[A]
 Functional statements
 application of Code, 3.1.1.[A]
 attributions, 1.1.3.1.
 building energy performance compliance path,
 8.5.1.1.
 building envelope, 3.5.1.1.
 electrical power systems and motors, 7.5.1.1.
 HVAC systems, 5.5.1.1.
 lighting, 4.5.1.1.
 list of, 3.2.1.1.[A]
 service water systems, 6.5.1.1.
 Furnaces
 (see also Heating, ventilating and air-conditioning
 (HVAC) systems)
 definition, 1.4.1.2.[A]
 efficiency requirements, 5.2.12.1.
 performance compliance, 8.4.4.7., 8.4.4.9., 8.4.5.3.

G

Garages, emergency vehicles, 4.2.1.6., 4.3.2.10.
 Garages, parking
 factors for occupancy control and personal control,
 4.3.2.10.
 HVAC system selection, 8.4.4.7.
 lighting power density, 4.2.1.5., 4.2.1.6.
 Garages, repair
 definition, 1.4.1.2.[A]
 factors for occupancy control and personal control,
 4.3.2.10.
 HVAC system selection, 8.4.4.7.
 lighting power density, 4.2.1.6.
 Garages, storage, 1.4.1.2.[A], 4.2.2.2.
 General lighting, 1.4.1.2.[A]
 Grade, 1.4.1.2.[A]
 Gross lighted area, 1.4.1.2.[A]
 Gymnasiums
 factors for occupancy control and personal control,
 4.3.2.10.
 HVAC system selection, 8.4.4.7.
 lighting power density, 4.2.1.5., 4.2.1.6.

H

- Hatches, 3.2.2.4.
- Healthcare facilities
 - factors for occupancy control and personal control, 4.3.2.10.
 - HVAC system selection, 8.4.4.7.
 - lighting controls, 4.2.2.1.
 - lighting power density, 4.2.1.5., 4.2.1.6.
- Heat maintenance systems, service water, 6.2.4.3.
- Heat pumps
 - controls, 5.2.8.5., 5.2.11.1.
 - efficiency requirements, 5.2.12.1.
 - performance compliance, 8.4.4.13.
 - service water heaters, 6.2.2.1.
- Heat recovery
 - dwelling units, 5.2.10.4.
 - equipment, 5.2.10.1., 5.2.10.4.
 - ice-making machines, 5.2.10.3., 8.4.3.9.
 - performance compliance, 8.4.2.10., 8.4.4.9., 8.4.4.17., 8.4.4.19.
 - prescriptive path, 5.2.10.
 - swimming pools, 5.2.10.2.
- Heat rejection equipment, 5.2.12.2.
- Heat traps, 1.4.1.2.[A], 6.2.3.1.
- Heaters/heating systems
 - (see also Heating, ventilating and air-conditioning (HVAC) equipment; Heating, ventilating and air-conditioning (HVAC) systems; Service water heating systems/equipment)
 - baseboard, 3.1.1.2., 8.4.4.7.
 - boosters, 6.2.5.1.
 - efficiency, 5.2.12.1., 6.2.2.1.
 - electric, 6.2.3.1.
 - electric-resistance, 5.2.8.6., 5.2.12.1., 8.4.4.7.
 - heat pumps, 5.2.8.5., 5.2.11.1., 5.2.12.1.
 - ice- and snow-melting, 5.2.8.7.
 - performance compliance, 8.4.2.10., 8.4.3.5., 8.4.4.6., 8.4.4.9., 8.4.4.20.
 - pools, 6.2.2.1., 6.2.7.1.
 - recessed, 3.2.1.2.
- Heating cables, 3.2.2.2., 3.2.3.1., 3.2.3.3.
- Heating, ventilating and air-conditioning (HVAC) equipment
 - (see also Heaters/heating systems; Heating, ventilating and air-conditioning (HVAC) systems)
 - baseboard heaters, 3.1.1.2., 8.4.4.7.
 - dampers, 5.2.4.
 - efficiency requirements, 5.2.12.
 - electric resistance heater units, 8.4.4.7.
 - outdoor installations, 5.2.7.
 - performance compliance, 8.4.4.8.
 - sizing, 5.2.1., 8.4.4.8.
- Heating, ventilating and air-conditioning (HVAC) equipments, dampers, 5.2.4.
- Heating, ventilating and air-conditioning (HVAC) systems
 - additions, 5.1.1.2., 8.4.1.4.
 - air distribution systems, 5.2.2., 8.4.4.7., 8.4.4.18.
 - air economizer systems, 5.2.2.8.
 - airflow control areas, 5.2.11.2.
 - application of Code, 5.1.1.2.
 - boilers (see Boilers)
 - compliance, 5.1.1.3.
 - control of, 5.2.2.8., 5.2.6.2., 5.2.11.2.
 - documentation, 2.2.2.5.[C]
 - ducts (see Ducts)
 - electrical distribution systems, 7.2.1.
 - fan system design, 5.2.3.
 - heat recovery (see Heat recovery)
 - humidification, 5.2.9.
 - load calculations, 5.2.1.1., 8.4.2.10., 8.4.3.8., 8.4.5.
 - monitoring, 7.2.1.1.
 - outdoor air, 5.2.2.7., 5.2.2.8., 5.2.2.9., 5.2.4.
 - performance compliance, 5.4.1.1., 8.4.2.2., 8.4.2.10., 8.4.3.1., 8.4.4.7., 8.4.4.12., 8.4.4.13.
 - pipes/piping, 5.2.5.
 - pumping system design, 5.2.6.
 - seasonal shutdown, 5.2.11.3.
 - selection, 8.4.4.7.
 - shut-off and setback controls, 5.2.11.
 - space-heating equipment used for service water heating, 6.2.2.4., 6.2.2.5.
 - system design, 5.2.1., 5.2.10.1.
 - temperature controls, 5.2.2.7., 5.2.6.2., 5.2.8., 5.2.11.2., 5.2.11.5., 8.4.3.7.
 - water economizer systems, 5.2.2.9.
- Hospitals, 4.2.1.5., 4.3.2.10.
- Hot tubs, 6.2.2.1., 6.2.7.2.
- Hot water (see Service water heating systems/equipment)
- Hotels/motels/guest rooms/suites
 - electrical power/metering, 7.2.1.1.
 - factors for occupancy control and personal control, 4.3.2.10.
 - lighting controls, 4.2.2.1., 4.2.2.6.
 - lighting power density, 4.2.1.5., 4.2.1.6.
- Humidification controls, 5.2.9.1.
- HVAC equipment (see Heating, ventilating and air-conditioning (HVAC) equipment)
- HVAC systems (see Heating, ventilating and air-conditioning (HVAC) systems)
- Hydronic pumps, 8.4.4.14.

I

- Ice-making machines, 5.2.10.3., 8.4.3.9., 8.4.4.7., 8.4.4.19.
- Ice-melting heater controls, 5.2.8.7.
- Ice plants (see Ice-making machines)
- Information required for proposed work, 2.2.2.[C]
- Installed interior lighting power
 - compliance, 4.3.1.3.
 - definition, 1.4.1.2.[A]
 - determination of, 4.2.1.4., 4.3.2.1.
 - limits to, 4.2.1.3.
 - performance path calculations, 8.4.3.4., 8.4.4.5.
- Insulation
 - continuity of, 3.2.1.2.
 - ducts and plenums, 5.2.2.5., 5.2.2.6.

- floors in contact with ground, 3.2.3.3.
- pipng, HVAC systems, 5.2.5.3., 5.2.5.4.
- pipng, service water, 6.2.3.1.
- protection of, in building envelope, 3.2.1.1.
- service water equipment, 6.2.2.2.
- walls in contact with ground, 3.2.3.1.
- water tanks, 6.2.2.2.
- Integrated energy-efficiency ratio (IEER), 1.4.1.2.[A]
- Integrated part-load value (IPLV), 1.4.1.2.[A]
- Interior lighting
 - controls, 4.2.1.6., 4.2.2.
 - definition, 1.4.1.2.[A]
 - energy consumption compliance, 4.3.1.3.
 - energy/power, 1.4.1.2.[A], 4.2.1., 4.3.2., 8.4.3.4., 8.4.4.5.
 - exit signs, 4.2.1.1.
 - monitoring, 7.2.1.1.
 - performance path calculations, 8.4.3.4., 8.4.4.5.
- Interior lighting energy allowance
 - building area method, 4.2.1.5.
 - calculations, 4.3.3.1.
 - compliance, 4.3.1.3.
 - definition, 1.4.1.2.[A]
 - limits to, 4.2.1.3.
 - prescriptive path, 4.2.1.
 - space-by-space method, 4.2.1.6.

J

- Joints, continuity of insulation, 3.2.1.2.

L

- Laboratories
 - factors for occupancy control and personal control, 4.3.2.10.
 - HVAC system selection, 8.4.4.7.
 - lighting controls, 4.2.2.1.
 - lighting power density, 4.2.1.6.
- Lamp ballasts, 4.2.1.2., 4.2.1.4.
- Lamps (see Lighting)
- Landscape lighting, 1.4.1.2.[A], 4.2.3.1.
- Laundry/washing areas, 4.2.1.6., 4.3.2.10.
- Lavatories
 - (see also Bathrooms)
 - factors for occupancy control and personal control, 4.3.2.10.
 - hot water service, 6.2.6.2.
 - lighting power density, 4.2.1.6.
- Leakage testing, ducts, 5.2.2.4.
- Libraries
 - factors for occupancy control and personal control, 4.3.2.10.
 - HVAC system selection, 8.4.4.7.
 - lighting power density, 4.2.1.5., 4.2.1.6.
- Lighting
 - additions, 8.4.1.4.
 - application of Code, 4.1.1.2.
 - ballasts, 4.2.1.2., 4.2.1.4.

- compliance, 4.1.1.3.
- controls (see Lighting controls)
- documentation, 2.2.2.4.[C]
- dwelling units, 4.1.1.2.
- emergency, 4.1.1.2.
- entrances and exits, 4.2.3.1., 4.2.4.1.
- exit signs, 4.2.1.1.
- exterior (see Exterior lighting)
- facade, 1.4.1.2.[A], 4.2.3.1.
- gross lighted area, 1.4.1.2.[A], 4.2.1.5.
- interior (see Interior lighting)
- landscape, 1.4.1.2.[A], 4.2.3.1.
- luminaires, 4.2.1.4., 4.2.3.1.
- performance compliance, 8.4.1.1., 8.4.2.2., 8.4.3.1., 8.4.3.2., 8.4.3.4., 8.4.4.5.
- power density, 4.2.1.5., 4.2.1.6., 4.3.2.2., 4.3.3.2.
- supplemental, 4.2.1.4., 4.2.2.6.
- trade-off path (see Lighting trade-off path)
- Lighting controls
 - automatic, 4.2.2.1., 4.2.4.1.
 - documentation, 2.2.2.4.[C]
 - exterior, 4.2.4.
 - interior, 4.2.1.6., 4.2.2.1.
 - performance path calculations, 8.4.3.4., 8.4.4.5.
 - sidelighting, 4.2.2.1.
 - special applications, 4.2.2.6.
 - storage garages, 4.2.2.2.
 - toplighting, 4.2.2.1.
 - trade-off path, 4.3.1.1., 4.3.2.5., 4.3.2.7., 4.3.2.10., 4.3.3.1., 4.3.3.5., 4.3.3.7., 4.3.3.10.
- Lighting trade-off path
 - application of Code, 4.3.1.1.
 - compliance, 4.3.1.3.
 - installed interior lighting energy, 4.3.2.
 - interior lighting energy allowance, 4.3.3.
 - limitations of Code application, 4.3.1.2.
- Limitations of compliance
 - back-up HVAC systems, 5.4.1.2.
 - back-up service water systems, 6.4.1.2.
 - building energy performance path, 8.4.1.3.
 - building envelope performance path, 3.4.1.2.
 - HVAC equipment, 5.4.1.2.
 - lighting trade-off path, 4.3.1.2.
- Load calculations
 - HVAC systems, 5.2.1.1., 8.4.2.10., 8.4.3.8., 8.4.5.
 - part-load, 8.4.5.
 - service water heating systems, 8.4.2.7.
- Loading docks, 3.2.4.3., 4.2.1.6.
- Loads
 - boilers, 5.2.11.4.
 - combination systems, service water heating, 6.2.2.4.
 - cooling with outdoor air, 5.2.2.7., 5.2.2.8., 5.2.2.9.
 - electrical motors, 7.2.4.1.
 - fan control, 5.2.3.3., 8.4.4.17.
 - heat pumps, 5.2.8.5.
 - monitoring, 7.2.1.1.
 - part-loads, 8.4.3.8., 8.4.4.14., 8.4.5.
 - performance, 8.4.3.5.
 - voltage drop, 7.2.2.1.
- Lobbies (see Vestibules)

Locker rooms, 4.2.1.6., 4.3.2.10.
Luminaires, 4.2.1.4., 4.2.2.6., 4.2.3.1.

M

Manufacturing facilities, 4.2.1.5., 4.2.1.6., 4.3.2.10.
Materials
 characteristics, 1.2.2.1.[A]
 standards, 1.3., 1.5.[A]
 storage, 1.2.2.2.[A]
 used, 1.2.2.3.[A]
Motors, electrical, 7.2.4.
Multi-purpose rooms
 factors for occupancy control and personal control, 4.3.2.10.
 HVAC system selection, 8.4.4.7.
 lighting power density, 4.2.1.6.
Multi-unit residential buildings
 HVAC system selection, 8.4.4.7.
 lighting power density, 4.2.1.5.
Multiple boilers, 5.2.11.4.
Museums
 factors for occupancy control and personal control, 4.3.2.10.
 HVAC system selection, 8.4.4.7.
 lighting power density, 4.2.1.5., 4.2.1.6.

N

Nominal thermal transmittance
 access hatches, 3.2.2.4.
 covers for pools and hot tubs, 6.2.7.2.

O

Objectives
 application of Code, 2.1.1.[A]
 attributions, 1.1.3.1.
 building energy performance compliance path, 8.5.1.1.
 building envelope, 3.5.1.1.
 electrical power systems and motors, 7.5.1.1.
 HVAC systems, 5.5.1.1.
 lighting, 4.5.1.1.
 list of, 2.2.1.1.[A]
 service water systems, 6.5.1.1.
Occupancy
 and energy performance path, 8.1.1.2., 8.4.3.2., 8.4.4.7.
 and HVAC system requirements, 5.1.1.2.
 and lavatory water shut-off controls, 6.2.6.2.
 definition, 1.4.1.2.[A]
 lighting requirement exemption, 4.1.1.2.
Occupancy-sensing mechanism
 factor to account for, 4.3.2.10., 4.3.3.10.
Office buildings/rooms
 factors for occupancy control and personal control, 4.3.2.10.

HVAC system selection, 8.4.4.7.
 lighting power density, 4.2.1.5., 4.2.1.6.
Opaque building assemblies
 air leakage, 3.2.4.3.
 definition, 1.4.1.2.[A]
 performance path calculations, 8.4.3.1., 8.4.4.3.
 thermal characteristics, 3.2.2.2.
Organizations (standards), 1.3.2., 1.5.2.[A]
Outdoor air
 controls, 5.2.4.1., 5.2.11.1., 5.2.11.2.
 cooling with, 5.2.2.7., 5.2.2.8., 5.2.2.9.
 performance path, 8.4.3.6., 8.4.4.12., 8.4.4.15., 8.4.4.18.
Outdoor equipment, 5.2.7.
Outdoor packaged units, gas-fired
 efficiency required, 5.2.12.1.
Overall thermal transmittance (U-value)
 above-ground assemblies, 3.2.2.
 building assemblies, 3.1.1.5.
 building assemblies in contact with ground, 3.2.3.
 calculation of, 3.1.1.7.
 continuity of insulation, 3.2.1.2.
 definition, 1.4.1.2.[A]
 documentation, 2.2.2.3.[C]
 doors, 3.2.2.4.
 floors, 3.2.2.2., 3.2.3.3.
 heaters, 3.2.1.2.
 performance path, 3.4.1.2., 8.4.3.1., 8.4.4.4.
 protection of insulation materials, 3.2.1.1.
 roofs, 3.2.2.2., 3.2.3.1., 3.2.3.2.
 service water tanks, 6.2.2.2.
 skylights, 3.2.2.3.
 spaces heated to different temperatures, 3.2.1.3.
 trade-off path, 3.3.1.1., 3.3.1.2.
 unconditioned enclosures, 3.1.1.7.
 vertical fenestration, 3.2.2.3.
 walls, 3.2.2.2., 3.2.3.1.
Overhead doors, 3.2.4.3.

P

Parking garages/areas
 factors for occupancy control and personal control, 4.3.2.10.
 HVAC system selection, 8.4.4.7.
 lighting power density, 4.2.1.5., 4.2.1.6.
Partitions, 1.4.1.2.[A]
Penitentiaries
 factors for occupancy control and personal control, 4.3.2.10.
 HVAC system selection, 8.4.4.7.
 lighting power density, 4.2.1.5., 4.2.1.6.
Performance compliance (see Building energy performance compliance path)
Pharmacies, 4.2.1.6., 4.3.2.10.
Photosensors for lighting control, 4.2.2.1., 4.2.4.1.
Pipes/piping
 building envelope, 3.2.1.2., 3.2.2.2.
 chilled fluid in, 5.2.5.4.
 design and installation, 5.2.5.1.

heat traps, 6.2.3.1.
 heating in floors, 8.4.4.16.
 HVAC systems, 5.2.5.
 in floors in contact with ground, 3.2.3.3.
 in walls in contact with ground, 3.2.3.1.
 insulation, 5.2.5.3., 6.2.3.1.
 overall thermal transmittance, calculation of, 3.1.1.7.
 suction-line, 5.2.5.3.
 thermal conductivity, 5.2.5.3., 6.2.3.1.
 Plans, information required, 2.2.2.1.[C]
 Plenums
 construction, installation and sealing, 5.2.2.3.
 definition, 1.4.1.2.[A]
 insulation, 5.2.2.5.
 Police stations, 4.2.1.5.
 Post offices, 4.2.1.5., 4.2.1.6., 4.3.2.10.
 Power (see Electrical power; Installed interior lighting power)
 Prescriptive compliance
 building envelope, 3.1.1.3.
 Code requirements, 1.1.2.1.
 electrical power systems and motors, 7.1.1.3.
 HVAC systems, 5.1.1.3.
 lighting, 4.1.1.3.
 service water systems, 6.1.1.3.
 Prescriptive requirements
 building energy performance, 8.1.1., 8.4.1., 8.4.2., 8.4.3., 8.4.4.
 building envelope, 3.2.
 Code compliance, 1.1.2.1.
 electrical power systems and motors, 7.2.
 HVAC systems, 5.2.
 lighting, 4.2.
 service water systems, 6.2.
 Pressure booster systems
 pressure controls, 6.2.8.2.
 size of water storage tank, 6.2.8.1.
 Primary systems, 1.4.1.2.[A]
 Process loads
 Code applicability, 1.1.1.2.[A]
 ice arenas, 5.2.10.3.
 interior lighting power, 4.2.1.5.
 performance compliance, 8.4.2.7., 8.4.4.7.
 pools, 5.2.10.2., 6.2.2.1., 6.2.7.1., 6.2.7.2., 8.4.4.7.
 Pumping systems
 design, 5.2.6.
 performance path, 8.4.4.9., 8.4.4.10., 8.4.4.11., 8.4.4.14., 8.4.4.19.
 power demand, 5.2.6.3.
 seasonal shutdown, 5.2.11.3.
 variable-flow, 5.2.6.2., 5.2.11.5.

R

Radiant heating systems
 above-ground, overall thermal transmittance, 3.2.2.2.

performance path, 8.4.4.16.
 roofs in contact with ground, overall thermal transmittance, 3.2.3.2.
 Recessed heaters, 3.2.1.2.
 Referenced documents, 1.3.1., 1.5.1.[A]
 Regulations, other, 1.1.1.3.[A]
 Reheating and recooling controls, 5.2.8.9.
 Religious buildings
 factors for occupancy control and personal control, 4.3.2.10.
 HVAC system selection, 8.4.4.7.
 lighting power density, 4.2.1.5., 4.2.1.6.
 Remote heaters, service water, 6.2.5.1.
 Repair garages
 definition, 1.4.1.2.[A]
 factors for occupancy control and personal control, 4.3.2.10.
 HVAC system selection, 8.4.4.7.
 lighting power density, 4.2.1.6.
 Requirements, conflicting with Code, 1.1.1.3.[A], 1.5.1.2.[A]
 Retail areas/spaces
 factors for occupancy control and personal control, 4.3.2.10.
 HVAC system selection, 8.4.4.7.
 lighting controls, 4.2.2.6.
 lighting power, 4.2.1.4., 4.2.1.5., 4.2.1.6.
 vestibules, 3.2.2.1.
 Return ducts, 1.4.1.2.[A], 5.2.2.3., 5.2.2.5.
 Revolving doors, 3.2.4.3.
 Roof monitors
 determination of daylighted area, 4.2.2.4., 4.2.2.5., 4.3.2.3.
 lighting controls, 4.2.2.1.
 Roofs/roof assemblies
 above-ground, 3.2.2.2.
 documentation, 2.2.2.3.[C]
 gross area, in relation to allowable skylight areas, 3.1.1.6., 3.2.2.3.
 in contact with ground, 3.2.3.2.
 overall thermal transmittance, calculation of, 3.1.1.7.
 performance path calculations, 8.4.2.8., 8.4.4.3.
 thermal requirements, 3.2.2.2., 3.2.3.2.

S

Sashes, 1.4.1.2.[A]
 Schools/universities, 4.2.1.5., 4.2.1.6.
 Scope of the Code
 all Divisions, 1.3.1.[A]
 building energy performance compliance, 8.1.1.1.
 building envelope, 3.1.1.1., 3.4.1.1.
 electrical power systems and motors, 7.1.1.1., 7.4.1.1.
 HVAC systems, 5.1.1.1., 5.4.1.1.
 lighting, 4.1.1.1., 4.4.1.1.
 performance compliance, 3.4.1.1., 4.4.1.1., 5.4.1.1., 6.4.1.1., 7.4.1.1.
 service water systems, 6.1.1.1., 6.4.1.1.

- Sealing tape, 5.2.2.3.
- Seasonal energy-efficiency ratio (SEER), 1.4.1.2.[A]
- Seasonal shutdown, 5.2.11.3., 6.2.4.2.
- Seating areas, 4.2.1.6., 4.3.2.10.
- Secondary systems, 1.4.1.2.[A]
- Semi-heated buildings, 3.2.1.3., 8.4.4.2.
- Service rooms
 - factors for occupancy control and personal control, 4.3.2.10.
 - lighting power density, 4.2.1.6.
- Service water, 1.4.1.2.[A]
- Service water heating systems/equipment
 - additions, 8.4.1.4.
 - application of Code, 6.1.1.2.
 - bathrooms, 6.2.6.
 - boilers (see Boilers)
 - booster heaters, 6.2.5.1.
 - combination equipment, 6.2.2.4., 6.2.2.5.
 - compliance, 6.1.1.3., 8.4.2.2.
 - controls, 6.2.4., 6.2.6.1., 6.2.7.1., 6.2.8.2.
 - documentation, 2.2.2.6.[C]
 - equipment efficiency, 6.2.2.1.
 - faucets, 6.2.6.2.
 - heat maintenance systems, 6.2.3.1.
 - heat pumps, 6.2.2.1.
 - heat traps, 6.2.3.1.
 - hot tubs, 6.2.2.1., 6.2.7.2.
 - insulation, 6.2.2.2., 6.2.3.1.
 - lavatories, 6.2.6.2.
 - limitations of Code application, 6.4.1.2.
 - load calculations, 8.4.2.7.
 - location, 6.2.3.1.
 - loop temperature reset controls, 5.2.11.5.
 - performance compliance, 6.1.1.3., 8.4.2.2.
 - performance path, 6.4., 8.4.2.7., 8.4.3.1., 8.4.3.2., 8.4.3.5., 8.4.4.2., 8.4.4.6., 8.4.4.19., 8.4.4.20., 8.4.5.
 - pipng, 6.2.3.
 - pressure booster systems, 6.2.8.
 - regulations, 6.2.1.1.
 - remote heaters, 6.2.5.1.
 - showers, 6.2.6.1.
 - shutdown controls, 6.2.4.2.
 - solar thermal, 6.2.2.3.
 - space heating equipment used for service water heating, 5.2.12.1., 6.2.2.4., 6.2.2.5.
 - space heating with, 5.2.12.4.
 - storage-type heaters, 1.4.1.2.[A]
 - storage vessels and heating equipment, 6.2.2.1.
 - swimming pools, 5.2.10.2., 6.2.2.1., 6.2.7., 8.4.4.7.
 - system design, 6.2.1.
 - temperature controls, 6.2.4.1., 6.2.4.3.
- Showers, 6.2.6.1.
- Shut-off and setback controls
 - airflow, 5.2.11.2.
 - loop temperature reset for water systems, 5.2.11.5.
 - multiple boilers, 5.2.11.4.
 - off-hours, 5.2.11.1.
 - seasonal shutdown, 5.2.11.3.
- Shutdown
 - seasonal, 5.2.11.3.
 - service water heating systems, 6.2.4.2.
- Sidelighting
 - definition, 1.4.1.2.[A]
 - determination of areas, 4.2.2.3.
 - lighting controls, 4.2.2.1.
 - trade-off path, 4.3.2.3., 4.3.2.7., 4.3.2.8., 4.3.3.3., 4.3.3.7.
- Signage, exits, 4.2.1.1.
- Sizing, equipment, 5.2.1., 8.4.4.8., 8.4.4.10.
- Skylights
 - (see also Fenestration)
 - air leakage, 3.2.4.3.
 - allowable area of, 3.1.1.6., 3.2.1.4.
 - definition, 1.4.1.2.[A]
 - determination of daylighted area, 4.2.2.5., 4.3.2.3.
 - documentation, 2.2.2.3.[C]
 - lighting controls, 4.2.2.1.
 - overall thermal transmittance, 3.2.2.3.
 - performance path calculations, 8.4.2.8.
- Sliding doors, commercial, 3.2.4.3.
- Smoke control equipment, 5.1.1.2., 5.2.10.1., 8.4.4.17.
- Snow-melting heater controls, 5.2.8.7.
- Solar absorptance, 8.4.4.3.
- Solar radiation, 8.4.2.8.
- Solar thermal service water heating equipment, 6.2.2.3.
- Space heaters
 - equipment using service water, 5.2.12.4.
- Space temperatures
 - controls, 5.2.8.1., 5.2.8.6., 5.2.8.9., 8.4.3.7., 8.4.4.16.
 - differing, 3.2.1.3.
 - energy model calculations, 8.4.2.5.
- Space types
 - HVAC system selection, 8.4.4.7.
 - lighting controls, 4.2.2.1., 4.3.2.10.
 - lighting power allowance calculations, 4.2.1.6.
- Space, unconditioned, 3.1.1.7., 5.2.4.1., 5.2.7.1., 6.2.3.1.
- Stairways/stairwells, 4.2.1.6.
- Standards
 - organizations, 1.3.2., 1.5.2.[A]
 - referenced documents, 1.3.1., 1.5.1.[A]
- Standby losses (SL), definition, 1.4.1.2.[A]
- Storage garages, 1.4.1.2.[A], 4.2.2.2.
- Storage on building site, 1.2.2.2.[A]
- Storage rooms, 4.2.1.6.
- Storage-type service water heater, 1.4.1.2.[A]
- Storage vessels, 6.2.2., 6.2.8.1.
- Storey, 1.4.1.2.[A]
- Suites, 1.4.1.2.[A]
- Sun porches, 3.1.1.7.
- Supply air handlers, 1.4.1.2.[A], 5.2.8.8.
- Supply ducts, 1.4.1.2.[A], 5.2.2.6.
- Swimming pools
 - covers, 6.2.7.2.
 - heat recovery, 5.2.10.2.
 - heaters, 6.2.2.1.
 - heating controls, 6.2.7.1.
 - performance path, 8.4.2.7., 8.4.4.7.
 - water systems, 6.2.7.
- Symbols used in the Code, 1.4.2.1.[A]
- Systems
 - characteristics, 1.2.2.1.[A]

performance path, 8.4.2.10., 8.4.4.7.
storage on building site, 1.2.2.2.[A]
used, 1.2.2.3.[A]

T

Temperature-control zones, 1.4.1.2.[A], 5.2.8.6., 5.2.8.9.
Temperature controls
airflow control areas, 5.2.11.2.
dwelling units, 5.2.8.1., 5.2.8.2.
HVAC systems, 5.2.2.7., 5.2.6.2., 5.2.8., 5.2.11.2.,
5.2.11.5., 8.4.3.7.
ice- and snow-melting heaters, 5.2.8.7.
installation, 5.2.8.4.
perimeter system, 5.2.8.6.
reheating and recooling, 5.2.8.9.
service water heating systems, 6.2.4.1., 6.2.4.3.
showers, 6.2.6.1.
shut-off and setback, 5.2.11.
spaces, 5.2.8.1., 5.2.8.6., 8.4.3.7., 8.4.4.16.
swimming pools, 6.2.7.1.
thermostats, 5.2.8.6., 5.2.11.1.
vestibules, 5.2.8.6.
Theatres
definition, 1.4.1.2.[A]
factors for occupancy control and personal control,
4.3.2.10.
HVAC system selection, 8.4.4.7.
lighting power density, 4.2.1.5., 4.2.1.6.
Thermal blocks
definition, 1.4.1.2.[A]
energy calculations, 8.4.2.6., 8.4.2.8., 8.4.4.18.
Thermal bridging effect, 3.1.1.7.
Thermal characteristics
access hatches, 3.2.2.4.
building assemblies in contact with ground, 3.2.3.
determination of, 3.1.1.5.
doors, 3.2.2.4.
fenestration, 3.2.2.3.
opaque building assemblies, 3.2.2.2.
performance path calculations, 8.4.1.4., 8.4.2.8.,
8.4.4.4.
Thermal efficiency, 1.4.1.2.[A]
Thermal mass, 8.4.2.4., 8.4.4.4.
Thermal transmittance (see Nominal thermal
transmittance; Overall thermal transmittance)
Thermostats/thermostatic controls (see Temperature
controls)
Toplighting
daylighted area, determination of, 4.2.2.4., 4.2.2.5.
definition, 1.4.1.2.[A]
lighting controls, 4.2.2.1.
trade-off path, 4.3.2.3., 4.3.2.7., 4.3.2.9., 4.3.3.3.,
4.3.3.7.
Town halls, 4.2.1.5.
Trade-off path
application and limitations, 3.3.1.1.
building envelope, 3.3.
calculations, 3.3.1.2.

Code requirements, 1.1.2.1.
lighting, 4.3.
Transformers, 7.2.3.1.
Transportation facilities, 4.2.1.5., 4.2.1.6., 4.3.2.10.

U

U-value (see Overall thermal transmittance)
Unconditioned spaces, 3.1.1.7., 5.2.4.1., 5.2.7.1., 6.2.3.1.
Unit heaters
definition, 1.4.1.2.[A]
Used materials, appliances and equipment, 1.2.2.3.[A]

V

Vapour barrier protection, 5.2.2.6., 5.2.5.3., 5.2.5.4.
Variable-air-volume
duct sealing exemption, 5.2.2.3.
fan power calculations, 8.4.4.17.
fan systems, 5.2.3.3., 5.2.11.2.
HVAC systems calculations, 8.4.2.10.
provision for balancing, 5.2.2.2.
shut-off and setback controls, 5.2.11.2.
Variable-flow pumping systems, 5.2.6.2., 5.2.11.5.,
8.4.4.14.
Variable refrigerant flow systems, 5.2.12.1.
Vehicle maintenance areas, 4.2.1.6., 4.3.2.10.
Ventilating systems (see Heating, ventilating and
air-conditioning (HVAC) systems)
Verandas, 3.1.1.7.
Vestibules
doors, 3.2.2.1.
factors for occupancy control and personal control,
4.3.2.10.
lighting power density, 4.2.1.6.
overall thermal transmittance, 3.1.1.7.
temperature controls, 5.2.8.6.

W

Walls/wall assemblies
above-ground, 3.2.2.2.
documentation, 2.2.2.3.[C]
foundations, 1.4.1.2.[A], 3.2.2.2., 3.2.3.3.
gross area, 3.1.1.6.
in contact with ground, 3.2.3.1.
insulation, 3.2.1.2., 3.2.3.1., 5.2.2.5.
overall thermal transmittance, 3.1.1.7., 3.2.2.2.,
3.2.3.1.
performance path calculations, 8.4.2.8.
Warehouses
factors for occupancy control and personal control,
4.3.2.10.
HVAC system selection, 8.4.4.7.
lighting power density, 4.2.1.5., 4.2.1.6.
Washrooms (see Lavatories)
Water economizer systems, 5.2.2.9.

Water pressure booster systems (see Pressure booster systems)

Water (see Service water)

Water tanks

insulation, 6.2.2.2.

overall thermal transmittance, 6.2.2.2.

pressure booster systems, 6.2.8.1.

Windows

(see also Fenestration)

air leakage, 3.2.4.3.

documentation, 2.2.2.3.[C]

Workshops, 4.2.1.5., 4.2.1.6., 4.3.2.10.

Z

Zones

climatic, 3.2.2., 3.2.3., 8.4.1.1.

heat recovery, 5.2.10.4.

HVAC, 5.2.2.3., 5.2.11.1., 5.2.11.2.

performance path, 8.4.4.7.

temperature, 1.4.1.2.[A], 5.2.8.6., 5.2.8.9.

Conversions

SI Units	Imperial Units	To convert SI units to imperial units, multiply by	To convert imperial units to SI units, multiply by
Temperature			
°C	°F	1.8 and add 32	subtract 32 divide by 1.8
Length			
mm	in.	0.03937	25.4
cm	in.	0.3937	2.54
m	ft.	3.281	0.3048
Area			
mm ²	in. ²	0.00155	645.16
cm ²	in. ²	0.155	6.4516
m ²	ft. ²	10.76	0.092903
Volume			
cm ³	in. ³	0.061	16.3871
m ³	ft. ³	35.31	0.02832
L	gal. (Imp)	0.22	4.55
L	gal. (US)	0.2642	3.785
Flow			
L/s	ft. ³ /min. (cfm)	2.11889	0.471947
L/min.	ft. ³ /min. (cfm)	0.0353	28.329
m ³ /h	ft. ³ /min. (cfm)	0.5886	1.699
Power			
W	Btu/h	3.413	0.2930711
Heat Flux			
W/m ²	Btu/h × ft. ²	0.317	3.154591
Overall Heat Transfer Coefficient (U-value)			
W/m ² × K	Btu/h × ft. ² × °F	0.17612	5.678263
W/m ² × °C	Btu/h × ft. ² × °F	0.17612	5.678263
Thermal Resistance			
m ² × °C/W (RSI)	ft. ² × h × °F/Btu (R)	5.678	0.17611
Thermal Conductivity, k			
W/m × K	Btu × in./h × ft. ² × °F	6.93347	0.1442279
W/m ² × °C (per m thickness)	Btu × ft./h × ft. ² × °F	0.5777	1.731
W/m ² × °C (per m thickness)	Btu × in./h × ft. ² × °F	6.9444	0.144
Pressure			
Pa	in. of water	0.004014	249
kPa	psi	0.145	6.895
kPa	psf	20.88	0.04788
Energy			
MJ	kWh	0.278	3.6
J	Btu	0.0009478	1055.056