

**CANADIAN
PLUMBING CODE
1975**

Issued by the

**Associate Committee on the National Building Code
National Research Council of Canada
Ottawa**

ARCHIVES

ASSOCIATE COMMITTEE ON THE NATIONAL BUILDING CODE

C. D. Carruthers (*Chairman*)
H. B. Dickens (*Deputy Chairman*)
V. S. Baker
J. G. Burchill
S. D. C. Chutter
R. F. DeGrace
P. Dobush
C. G. E. Downing
J. T. Gregg
W. B. Guihan
R. V. Hebert
J. S. Hicks
H. T. Jones

J. Longworth
A. T. Mann
C. J. McConnell
R. N. McManus
A. T. Muir
F. X. Perreault
G. B. Pope
H. R. Stenson
R. A. W. Switzer
J. M. Verreault
C. J. Ward

D. W. Boyd (*Research
Advisor—Meteorology*)
R. S. Ferguson (*Research Advisor*)
R. H. Dunn (*Secretary*)

Retired*

J. D. Beaty (*Deceased*)
R. A. Bird
W. G. Connelly
I. Coop
R. M. Dillon

T. R. Durley (*Deceased*)
S. A. Gitterman
A. Matthews
K. R. Rybka
D. H. Waller
J. M. Robertson (*Secretary until
January, 1973*)

STANDING COMMITTEE ON PLUMBING SERVICES

V. S. Baker (*Chairman*)
E. H. Anaka
G. D. Anderson
B. M. Bolduc
D. C. Champion
W. DeLaMare
T. Dixon
K. C. Ford
L. Hardy
R. J. Hunt
B. Kellam
A. A. Knapp
V. J. Mann
R. A. McCurdy
A. W. McIntyre

W. A. Milligan
D. H. Minty
P. G. Spent
L. F. Stanbrook
J. E. Stott
G. L. Swain
A. D. Thompson
D. H. Waller
C. J. Ward

R. K. Beach (*Research Advisor*)
J. F. K. Summers (*Secretary*)

Retired*

H. Hudon
J. Leeming

T. Pe'llow
H. J. Taylor

*Committee term completed during preparation of 1975 Code

**CANADIAN
PLUMBING CODE
1975**

Issued by the

**Associate Committee on the National Building Code
National Research Council of Canada
Ottawa**

NRCC No. 13983

First Edition 1970
Second Edition 1975

© National Research Council of Canada 1975

Printed in Canada

TABLE OF CONTENTS

	Page
PREFACE	vii
SECTION 1 GENERAL REQUIREMENTS AND ADMINISTRATION	1
Subsection 1.1 Application	1
Subsection 1.2 Scope	1
Subsection 1.3 Definitions and Abbreviations	1
Subsection 1.4 Equivalents	7
Subsection 1.5 Plumbing Facilities	7
Subsection 1.6 Service Connections	7
Subsection 1.7 Location of Fixtures	7
Subsection 1.8 Permits	7
Subsection 1.9 Inspection and Testing	8
SECTION 2 MATERIALS AND EQUIPMENT	9
Subsection 2.1 General	9
Subsection 2.2 Fixtures	9
Subsection 2.3 Traps and Interceptors	10
Subsection 2.4 Pipe Fittings	10
Subsection 2.5 Non-Metallic Pipe and Fittings	11
Subsection 2.6 Ferrous Pipe and Fittings	13
Subsection 2.7 Non-Ferrous Pipe and Fittings	14
Subsection 2.8 Jointing Materials	16
Subsection 2.9 Miscellaneous Materials	16
SECTION 3 PIPING	17
Subsection 3.1 Application	17
Subsection 3.2 Construction and Use of Joints	17
Subsection 3.3 Joints and Connections	19
Subsection 3.4 Support of Piping	20
Subsection 3.5 Protection of Piping	21
Subsection 3.6 Testing of Drainage and Venting Systems	22
Subsection 3.7 Testing of Potable Water Systems	23

	Page
SECTION 4 DRAINAGE SYSTEMS	23
Subsection 4.1 Application	23
Subsection 4.2 Connections to Drainage Systems	23
Subsection 4.3 Location of Fixtures	25
Subsection 4.4 Treatment of Sewage and Wastes	25
Subsection 4.5 Traps	26
Subsection 4.6 Arrangement of Drainage Piping	27
Subsection 4.7 Cleanouts	27
Subsection 4.8 Minimum Slope and Length of Drainage Pipes	29
Subsection 4.9 Size of Drainage Pipes	29
Subsection 4.10 Hydraulic Loads	31
SECTION 5 VENTING SYSTEMS	35
Subsection 5.1 Vent Pipes for Traps	35
Subsection 5.2 Single Storey Wet Venting	36
Subsection 5.3 Vent Pipes for Soil-or-Waste Stacks	36
Subsection 5.4 Miscellaneous Vent Pipes	37
Subsection 5.5 Arrangement of Vent Pipes	37
Subsection 5.6 Minimum Size of Vent Pipes	38
Subsection 5.7 Sizing of Vent Pipes	39
SECTION 6 POTABLE WATER SYSTEMS	42
Subsection 6.1 Arrangement of Piping	42
Subsection 6.2 Protection from Contamination	43
Subsection 6.3 Tanks	45
Subsection 6.4 Wells	45
Subsection 6.5 Size and Capacity of Pipes	45
SECTION 7 NON-POTABLE WATER SYSTEMS	46
Subsection 7.1 Connection	46
Subsection 7.2 Identification	46
Subsection 7.3 Location	46
APPENDIX	49
INDEX	99

PREFACE

The 1975 edition of the Canadian Plumbing Code contains the requirements for the design and installation of plumbing systems, formerly in Part 7 of the National Building Code of Canada 1970. All explanatory material which appeared in light-face type in the 1970 edition of the Canadian Plumbing Code and all diagrams are now contained in an Appendix, leaving the body of the Code consisting of regulatory material only.

The decimal numbering system is similar to the previous edition, except that use of the digit "7" designating Part 7 of the National Building Code is no longer necessary.

The first line of each item in the Appendix contains in bold-face type a reference to the definition or requirement to which the explanatory material is applicable. These references have been placed in alphabetical or numerical order to ensure that they are easily found when they are referred to in the text.

Where metric equivalents have been included in this code, they are not intended to have legal significance as they are approximations only.

The Canadian Plumbing Code is published by the National Research Council of Canada and is prepared under the auspices of the Associate Committee on the National Building Code.

It is one of a special code series published separately from but referenced in the National Building Code of Canada. It can thus be adopted for legal use by a municipality or provincial body jointly with or separately from the National Building Code.

Enquiries regarding this document should be directed to: The Secretary, Associate Committee on the National Building Code, National Research Council of Canada, Ottawa, Ontario K1A 0R6.

Le Code national du bâtiment, ses suppléments et les documents qui s'y rattachent sont disponibles en français. On peut se les procurer en s'adressant au Secrétaire, Comité associé du Code national du bâtiment, Conseil national de recherches du Canada, Ottawa, Ontario K1A 0R6.

SECTION 1 GENERAL REQUIREMENTS AND ADMINISTRATION

SUBSECTION 1.1 APPLICATION

1.1.1. This Code applies to the construction, extension, alteration, renewal or repair of *plumbing systems* in every building.

1.1.2. In addition to the administrative requirements of this Code, the appropriate requirements in Part 2 of the National Building Code of Canada 1975 shall apply.

SUBSECTION 1.2 SCOPE

1.2.1. This Code specifies the minimum requirements for (a) *drainage systems* for water-borne wastes and *storm water* for buildings to the point of connection with public services or other approved disposal point, (b) *water distribution systems*, and (c) *water service pipes*. Scope

SUBSECTION 1.3 DEFINITIONS AND ABBREVIATIONS

1.3.1. Definitions of words and phrases used in this Code that are not included in the list of definitions in this Section shall have the meanings which are commonly assigned to them in the context in which they are used in this Code, taking into account the specialized use of terms by the various trades and professions to which the terminology applies. Definitions

1.3.2. The words and terms in italics in this Code shall have the following meanings:

Air break means the unobstructed distance between the lowest point of an indirect *drainage system* and the *flood level rim* of the *fixture* into which it discharges. (See Appendix explaining Sentence 3.3.11.(2).)

Air gap means the unobstructed vertical distance through air between the lowest point of a water supply outlet and the *flood level rim* of the *fixture* or device into which the outlet discharges. (See Appendix explaining Sentence 6.2.4.(1).)

Alloyed zinc means an alloy of zinc having the corrosion resistance and physical properties of an alloy containing 0.15 per cent titanium, 0.74 per cent copper and 99.11 per cent zinc, and so tempered as to be capable of being formed into the shape required for a watertight joint.

Appliance means a receptacle or equipment that receives or collects water, liquids or *sewage* and discharges water, liquids or *sewage* either directly or indirectly to a *plumbing system*. (See also the definition for *fixture*.)

Appropriate authority having jurisdiction means the departments of the provincial governments and agents thereof that have authority over the subject that is regulated.

Approved means approved by the *authority having jurisdiction* or the *appropriate authority having jurisdiction*.

Authority having jurisdiction means

- (a) with respect to the proclamation and amendment of this Code, and the creation of a Board of Appeal, the adopting governmental body, or
- (b) with respect to the administration of this Code, the person (designated official) appointed by the adopting governmental body and any person authorized by him to administer this Code.

Backflow means a flowing back or reversal of the normal direction of the flow.

Backflow preventer means a device or a method that prevents *backflow*. (See Appendix.)

- Back-siphonage* means *backflow* caused by atmospheric pressure. (See Appendix.)
- Back-siphonage preventer* (or vacuum breaker) means a device or a method that prevents *back-siphonage*. (See Appendix.)
- Backwater valve* means a *check valve* designed for use in a gravity *drainage system*.
- Branch* means a *soil-or-waste pipe* located in 1 *storey*, connected at its upstream end to the junction of 2 or more *soil-or-waste pipes* or to a *soil-or-waste stack*, and connected at its downstream end to another *branch*, a *soil-or-waste stack* or a *building drain*. (See Appendix explaining definition for drainage system.)
- Branch vent* means a *vent pipe* that is connected at its lower end to the junction of 2 or more *vent pipes*, and is connected at its upper end either to a *stack vent*, *vent stack* or *header*, or is terminated in open air. (See Appendix.)
- Building* means any structure used or intended for supporting or sheltering any use or *occupancy*.
- Building drain* means the horizontal piping, including any vertical *offset* that conducts *sewage*, *clear-water waste* or *storm water* to a *building sewer*. (See Appendix explaining definition for drainage system.)
- Building sewer* means a pipe that is connected to a *building drain* 3 ft (0.91 m) outside a wall of a *building* and that leads to a public sewer or *private sewage disposal system*.
- Building trap* means a *trap* that is installed in a *building drain* or *building sewer* to prevent circulation of air between a *drainage system* and a public sewer. (See Appendix explaining Sentence 4.5.4.(1).)
- Check valve* means a valve that permits flow in one direction but prevents a return flow.
- Circuit vent* means a *vent pipe* that serves a number of *fixtures* and connects to the *fixture drain* of the most upstream *fixture*. (See Appendix.)
- Cleanout* means an access provided in *drainage* and *venting systems* to provide for cleaning and inspection services.
- Clear-water waste* means water that does not contain *sewage* or *storm water*. (See Appendix.)
- Combined building drain* means a *building drain* that is intended to conduct *sewage* and *storm water*.
- Combined building sewer* means a *building sewer* that is intended to conduct *sewage* and *storm water*.
- Combined sewer* means a sewer that is intended to conduct *sewage* and *storm water*.
- Combustible* (as applying to an elementary building material) means that such material fails to conform to CSA B54.1-1972, "Determination of Non-combustibility in Building Materials."
- Continuous vent* means a *vent pipe* that is an extension of a vertical section of a *branch* or *fixture drain*.
- Critical level* means the level of submergence at which the *back-siphonage preventer* ceases to prevent *back-siphonage*.
- Dead end* means a pipe that terminates with a closed fitting.
- Developed length* means the length along the centre line of the pipe and fittings. (See Appendix explaining Sentence 5.5.3.(1).)
- Directly connected* means physically connected in such a way that water or gas cannot escape from the connection.
- Drainage system* means an assembly of pipes, fittings, *fixtures*, *traps* and appurtenances that is used to convey *sewage*, *clear-water waste* or *storm water* to a public sewer or a *private sewage disposal system*, but does not include *subsoil drainage pipes*. (See Appendix.)

- Dual vent* means a *vent pipe* that serves 2 *fixtures* and connects at the junction of the *fixture drains*. (See Appendix explaining definition for *drainage system*.)
- Dwelling unit* means a room or suite of rooms operated as a housekeeping unit used or intended to be used as a domicile by 1 or more persons and usually containing cooking, eating, living, sleeping and sanitary facilities.
- Effective opening* means an opening that has a cross-sectional area equal to the minimum area through which water is discharged at a discharge opening, control valve inlet or control valve seat of a water supply inlet to a *fixture* or device. (See Appendix.)
- Fire separation* means a construction assembly that acts as a barrier against the spread of fire, and may not be required to have a fire-resistance rating or a fire-protection rating.
- Fire stop* means a draft-tight barrier within or between construction assemblies that acts to retard the passage of smoke and flame.
- Fixture* means a receptacle, *appliance*, apparatus or other device that discharges *sewage* or *clear-water waste*, and includes a floor drain.
- Fixture drain* means the pipe that connects a *trap* serving a *fixture* to another part of a *drainage system*. (See Appendix.)
- Fixture outlet pipe* means a pipe that connects the waste opening of a *fixture* to the *trap* serving the *fixture*. (See Appendix.)
- Fixture unit* means the unit of measure based on the rate of discharge, time of operation and frequency of use of a *fixture* that expresses the hydraulic load that is imposed by that *fixture* on the *drainage system*.
- Flood level rim* means the top edge at which water can overflow from a *fixture* or device. (See Appendix explaining definition for back-siphonage.)
- Flow control roof drain* means a *roof drain* that restricts the flow of *storm water* into the *storm drainage system*.
- Fresh air inlet* means a *vent pipe* that is installed in conjunction with a *building trap* and terminates outdoors. (See Appendix explaining Sentence 4.5.4.(1).)
- Frost-proof closet* means a water closet that has no water in the bowl and has a *trap* and water control valve that are designed for installation below the frost line.
- Header* means a *vent pipe* that connects 2 or more *vent stacks* or *stack vents* to outdoors. (See Appendix.)
- Indirect service water heater* (see *service water heater, indirect*).
- Indirectly connected* means not *directly connected*. (See Appendix explaining Sentence 3.3.11.(2).)
- Individual vent* means a *vent pipe* that serves 1 *fixture*.
- Interceptor* means a receptacle that is installed to prevent oil, grease, sand or other materials from passing into a *drainage system*.
- Leader* means a pipe that is installed to carry *storm water* from a roof to a *storm building drain* or *sewer* or other place of disposal.
- Loop vent* (see *circuit vent*). (See Appendix explaining definition for *drainage system*.)
- Nominally horizontal* means at an angle of less than 45 deg. with the horizontal. (See Appendix.)
- Nominally vertical* means at an angle of not more than 45 deg. with the vertical. (See Appendix.)
- Noncombustible* (as applying to an elementary building material) means that such material conforms to CSA B54.1-1972, "Determination of Noncombustibility in Building Materials."
- Occupancy* means the use or intended use of a *building* or part thereof for the shelter or support of persons, animals or property.
- Offset* means the piping that connects the ends of 2 pipes that are parallel. (See Appendix.)

- Owner* means any person, firm or corporation controlling the property under consideration.
- Permit* means permission or authorization in writing by the *authority having jurisdiction* to perform work regulated by this Code and, in the case of an occupancy permit, to occupy any *building* or part thereof.
- Plumbing contractor* means a person, corporation or firm that undertakes to construct, extend, alter, renew or repair any part of a *plumbing system*.
- Plumbing system* means a *drainage system*, a *venting system* and a *water system* or parts thereof. (See Appendix.)
- Potable* means safe for human consumption.
- Private sewage disposal system* means a privately owned plant for the treatment and disposal of *sewage* (such as a septic tank with an absorption field).
- Private water supply system* means an assembly of pipes, fittings, valves, equipment and appurtenances that supplies water from a private source to a *water distribution system*.
- Relief vent* means an auxiliary vent which provides additional circulation of air between *drainage systems* and *venting systems*.
- Riser* means a water distribution pipe that extends through at least 1 full *storey*.
- Roof drain* means a fitting or device that is installed in the roof to permit *storm water* to discharge into a *leader*.
- Sanitary building drain* means a *building drain* that conducts *sewage*.
- Sanitary building sewer* means a *building sewer* that conducts *sewage*.
- Sanitary drainage system* means a *drainage system* that conducts *sewage*.
- Sanitary sewer* means a sewer that conducts *sewage*.
- Service water heater* means a device for heating water for plumbing services.
- Service water heater, indirect* means a *service water heater* that derives its heat from a heating medium such as warm air, steam or hot water.
- Service water heater, storage type* means a *service water heater* with an integral hot water storage tank.
- Sewage* means liquid waste that contains animal, mineral or vegetable matter.
- Size* means the nominal diameter by which a pipe, fitting, *trap* or other similar item is commercially designated.
- Soil-or-waste pipe* means a pipe in a *sanitary drainage system*.
- Soil-or-waste stack* means a vertical *soil-or-waste pipe* that passes through 1 or more *storeys*, and includes any *offset* that is part of the stack.
- Stack vent* means a *vent pipe* that connects the top of a *soil-or-waste stack* to a *header* or open air. (See Appendix explaining definition for drainage system.)
- Storage-type service water heater* (see *service water heater, storage type*).
- Storey* means the interval between 2 successive floor levels, or floor level and roof.
- Storm building drain* means a *building drain* that conveys *storm water*.
- Storm building sewer* means a *building sewer* that conveys *storm water*.
- Storm drainage system* means a *drainage system* that conveys *storm water*.
- Storm sewer* means a sewer that conveys *storm water*.
- Storm water* means water that is discharged from a surface as a result of rainfall or snowfall.
- Subdrainage system* means a *drainage system* that does not drain by gravity to the *building sewer*.
- Subsoil drainage pipe* means a pipe that is installed underground to intercept and convey subsurface water.
- Trap* means a fitting or device that is designed to hold a liquid seal that will prevent the passage of gas but will not materially affect the flow of a liquid.
- Trap arm* means that portion of a *fixture drain* between the *trap weir* and the *vent pipe* connection.
- Trap dip* means the lowest part of the upper interior surface of a *trap*.
- Trap seal* means the vertical distance between the *trap dip* and the *trap weir*.

Trap standard means the *trap* for a *fixture* that is integral with the support for the *fixture*.

Trap weir means the highest part of the lower interior surface of a *trap*. (See Appendix explaining Sentences 2.3.1.(1) and (2).)

Vacuum breaker (see *back-siphonage preventer*).

Vent pipe means a pipe that is a part of a *venting system*.

Vent stack means a *vent pipe* that is connected at its upper end to a *header* or is terminated in open air and that is used to limit pressure differential in a *soil-or-waste stack*. (See Appendix explaining definition for drainage system.)

Venting system means an assembly of pipes and fittings that connects a *drainage system* with outside air for circulation of air and the protection of *trap seals* in the *drainage system*. (See Appendix explaining definition for drainage system.)

Waste pipe (see *soil-or-waste pipe*).

Water distribution system means an assembly of pipes, fittings, valves and appurtenances that conveys water from the *water service pipe* or *private water supply system* to water supply outlets, *fixtures*, *appliances* and devices.

Water service pipe means a pipe that conveys water from a public water main or private water source to the inside of the *building*.

Water system means a *private water supply system*, a *water service pipe*, a *water distribution system* or parts thereof.

Wet vent means a *soil-or-waste pipe* that also serves as a *vent pipe*. (See Appendix explaining Article 5.7.1.)

Yoke vent means a *vent pipe* that is connected at its lower end to a *soil-or-waste stack* and at its upper end to a *vent stack* or a *branch vent* that is connected to a *vent stack*.

Abbreviations

1.3.3. Abbreviations in this Code for the names of organizations or authorities have the following meanings:

ACNBC	Associate Committee on the National Building Code (National Research Council of Canada Ottawa, Ontario K1A 0R6)
ANSI	American National Standards Institute (1430 Broadway, New York, New York 10018 U.S.A.)
ASHRAE	American Society of Heating, Refrigerating and Air- Conditioning Engineers (345 East 47th Street, New York, New York 10017 U.S.A.)
ASTM	American Society for Testing and Materials (1916 Race Street, Philadelphia, Pa. 19103 U.S.A.)
CGSB	Canadian Government Specifications Board (c/o Department of Supply and Services 88 Metcalfe Street, Ottawa, Ontario K1A 0S5)
CSA	Canadian Standards Association (178 Rexdale Blvd., Rexdale, Ontario M9W 1R3)
NBC	National Building Code of Canada (National Research Council of Canada Ottawa, Ontario K1A 0R6)

1.3.4. Abbreviations of words and phrases in this Code have the following meanings:

ABS	acrylonitrile-butadiene-styrene
°C	degree(s) Celsius
CPVC	chlorinated poly (vinyl chloride)
deg.	degree(s)
diam.	diameter
°F	degree(s) Fahrenheit
ft	foot (feet)
ft/sec.	foot (feet) per second
gal.	gallon(s)
gpm	gallon(s) per minute
hr	hour(s)
in.	inch(es)
kg	kilogram(s)
k	kilo
l	litre(s)
lb	pound(s)
max.	maximum
m	metre(s)
m ²	square metre(s)
mm	millimetre(s)
min.	minimum
min.	minute(s)
N	Newton(s)
N/m	Newton(s) per metre
N/m ²	Newton(s) per square metre
No.	number(s)
oz	ounce(s)
psf	pound(s) per square foot
psi	pound(s) per square inch
psig	pound(s) per square inch gauge
PVC	poly (vinyl chloride)
sq ft	square foot (feet)
sq in	square inch(es)
temp.	temperature

SUBSECTION 1.4 EQUIVALENTS

1.4.1. Any *owner* desirous of using a material or method of design as an equivalent to the requirement of this Code shall submit to the *authority having jurisdiction* sufficient evidence to satisfy the *appropriate authority having jurisdiction* that the proposed equivalent will provide the level of performance required by this Code.

SUBSECTION 1.5 PLUMBING FACILITIES

1.5.1. Plumbing facilities shall be provided in accordance with Subsection 3.6.4. of Part 3 and Section 9.32 of Part 9 of the National Building Code of Canada 1975.

SUBSECTION 1.6 SERVICE CONNECTIONS

1.6.1.(1) Every *sanitary drainage system* shall be connected to a public *sanitary sewer*, a public *combined sewer* or a *private sewage disposal system*. Sanitary drainage systems

(2) A *combined building drain* shall not be installed unless *approved*.

1.6.2. Every *storm drainage system* shall be connected to a public *storm sewer*, a public *combined sewer* or as designated by the *authority having jurisdiction*. Storm drainage systems

1.6.3. Every *water distribution system* shall be connected to a public water main, a *private potable water supply system* or other *approved* source of water. Water distribution systems

1.6.4. Piping in any *building* shall be connected to the public services separately from piping of any other *building*, except that an ancillary *building* on the same property may be served by the same service. (See Appendix.) Separate services

SUBSECTION 1.7 LOCATION OF FIXTURES

1.7.1.(1) Plumbing *fixtures* shall not be installed in a room that is not lighted and ventilated in accordance with the appropriate requirements in Parts 3 and 9 of the National Building Code of Canada 1975. Location of fixtures

(2) When a water closet is installed in a public washroom it shall be provided with a seat of the open front type.

SUBSECTION 1.8 PERMITS

1.8.1.(1) Except as provided in Sentence (2), a *plumbing system* shall not be constructed, extended, altered, renewed or repaired or a connection made to a sewer unless a *permit* to do so has been obtained. Permits required

(2) A *permit* is not required when a valve, faucet, *fixture* or *service water heater* is repaired or replaced, a stoppage cleared or a leak repaired if no change to the piping is required.

(3) An application for a *permit* shall be made to the *authority having jurisdiction*.

(4) A *permit* shall be issued only to a home *owner* to do work on a single family *dwelling unit* owned and occupied or to be occupied by himself, or to a *plumbing contractor* who meets the qualifications that are prescribed in . . .*

1.8.2.(1) An application for a *permit* shall be made on the form that is provided by the *authority having jurisdiction*. Application for permit

Sentences marked (*) will vary with local practice and space is left for the appropriate reference.

- (2) Every application shall be accompanied by
 - (a) the fee that is set forth in . . .*, and
 - (b) a specification or description of proposed work.

(3) When required by the *authority having jurisdiction*, the application shall also be accompanied by

- (a) a plan that shows the location and *size* of every *building drain*, and of every *trap* and *cleanout* fitting that is on a *building drain*,
- (b) a sectional drawing that shows the *size* and location of every *soil-or-waste pipe*, *trap* and *vent pipe*, and
- (c) a plan that shows a layout of the *potable water distribution system* including pipe *sizes* and valves.

(4) Where a *permit* has been issued, no departure shall be made from the specification, description, plan or sectional drawing unless written permission is obtained from the *authority having jurisdiction*.

SUBSECTION 1.9 INSPECTION AND TESTING

Inspection and testing

1.9.1.(1) Where a *permit* is required as described in Subsection 1.8., the system shall not be put into use until it has been inspected and tested to the satisfaction of the *authority having jurisdiction*.

(2) A piping system that has been fabricated off the site and that has been *approved* need not be retested except as may be required by Sentence 1.9.2.(1), Sentence 3.6.1.(3) and Sentence 3.7.1.(3).

(3) The *plumbing contractor* shall notify the *authority having jurisdiction* when the work is complete and ready to be inspected or tested.

(4) The *plumbing contractor* shall furnish any equipment, material, power or labour that is necessary for inspection or testing.

(5) If any part of a *plumbing system* is covered before it has been inspected and *approved*, it shall be uncovered if the *authority having jurisdiction* so directs.

(6) If any part of a *plumbing system* is not *approved* after it has been inspected or tested, the *plumbing contractor* shall make any alteration or replacement that is necessary and the work shall be subjected to further inspection or testing.

Reinspection of existing systems

1.9.2.(1) The *authority having jurisdiction* may inspect an existing *plumbing system*, and where there is reason to suspect that the system is not satisfactory, order it to be tested.

(2) If any part of the system has become or is in a condition that it may become dangerous or injurious to health, the *owner* shall make any alteration or replacement ordered in writing by the *authority having jurisdiction*.

Certificate of approval

1.9.3. When a *plumbing system* has been completed and has been *approved*, the *authority having jurisdiction*, when requested, shall issue a certificate of approval to the *owner* and to the *plumbing contractor*.

Sentences marked (*) will vary with local practice and space is left for the appropriate reference.

1.9.4. The granting of a *permit*, the approval of a specification or plan or an inspection or test that is made by the *authority having jurisdiction* does not in any way relieve the *owner* or his agent of full responsibility for carrying out work on a *plumbing system* in complete accordance with this Code.

Responsibility

SECTION 2 MATERIALS AND EQUIPMENT

SUBSECTION 2.1 GENERAL

2.1.1. In addition to the requirements of this Subsection, the appropriate requirements of Part 5 of the National Building Code of Canada 1975 shall apply.

2.1.2. All materials and equipment shall be free from defects that affect their usefulness for their intended purposes.

Defects in products and materials

2.1.3. Where unusual conditions exist such as excessively corrosive soil or water, only materials suited for use in such locations shall be used.

Exposure of materials

2.1.4.(1) Materials and equipment including *fixtures* shall not be re-used unless the written consent of the *authority having jurisdiction* has been received.

Restriction on re-use

(2) Materials and equipment that have been used for a purpose other than the distribution of *potable* water shall not be subsequently used in a *potable water system*.

2.1.5. Every length of pipe and every fitting shall have cast, stamped or indelibly marked on it the maker's name or mark and the weight or class or quality of the product, or it shall be marked in accordance with the relevant standard, and such markings shall be visible after installation.

Identification

SUBSECTION 2.2 FIXTURES

2.2.1. Every *fixture* shall have a smooth, hard corrosion-resistant surface free from flaws and blemishes that may interfere with cleaning.

2.2.2.(1) Every vitreous china *fixture* shall conform to CSA B45.1-1973, "Vitreous China Plumbing Fixtures."

(2) Every stainless steel *fixture* shall conform to CSA B45.4-1970, "Stainless Steel Plumbing Fixtures."

(3) Every polyester composite *fixture* shall conform to CSA B45.5-1972, "Polyester Composite Plumbing Fixtures."

2.2.3.(1) Concrete laundry trays shall

Laundry trays

- (a) be strong and dense,
- (b) be moulded in 1 piece,
- (c) have rounded corners,
- (d) have a wall thickness of at least 1½ in. (29 mm) at the top and 1¼ in. (32 mm) at the bottom, and
- (e) have a bottom thickness of at least 1¼ in. (32 mm).

2.2.4.(1) Every shower receptor shall be constructed and arranged so that water cannot leak through the walls or floor.

Shower receptors

(2) Not more than 6 shower heads shall be served by a single waste opening.

(3) Where 2 or more shower heads are served by a waste opening, the floor shall be sloped and the opening located so that water from one head cannot flow over the area that serves another head. (See Appendix.)

(4) The minimum interior dimension of a shower receptor shall be 30 in. (762 mm).

(5) When shower heads are installed in series, the horizontal distance between 2 adjacent shower heads shall be at least 30 in. (762 mm).

Construction of water closet bowl

2.2.5. Every water closet bowl or urinal made of other than vitreous china shall comply with the applicable requirements of CSA B45.1-1973, "Vitreous China Plumbing Fixtures."

Construction of overflow

2.2.6.(1) Except as provided in Sentences 2.2.2.(1) and (3), an overflow on a *fixture* shall be constructed so that

- (a) the area of the overflow and the overflow pipe or passage is at least ½ the area of the *fixture outlet pipe*,
- (b) the overflow pipe or passage is connected to the *fixture outlet pipe*, and
- (c) the overflow pipe can be readily and effectively cleaned.

(2) A dishwashing sink and a food preparation sink shall not have an overflow. (See Appendix.)

SUBSECTION 2.3 TRAPS AND INTERCEPTORS

Traps

2.3.1.(1) Every *trap* shall

- (a) have a *trap seal* at least 1½ in. (38 mm) in depth,
- (b) be self-cleaning,
- (c) be so designed that failure of the seal walls will cause exterior leakage, and
- (d) have a water seal that does not depend on the action of moving parts. (See Appendix.)

(2) Every *trap* that serves a lavatory, a sink or a laundry tray shall

- (a) be provided with a *cleanout* plug located at the lowest point of the *trap* and of the same material as the *trap*, except that a cast-iron *trap* shall be provided with a brass *cleanout* plug, or
- (b) be designed so that part of the *trap* can be completely removed by screwed connections for cleaning purposes. (See Appendix.)

(3) A bell *trap* or a drum *trap* shall not be installed in a *drainage system*. (See Appendix.)

Interceptors

2.3.2.(1) Every *interceptor* shall be designed so that it can be readily cleaned.

(2) Every grease *interceptor* shall be designed so that it does not become air bound and it shall not have a water jacket.

SUBSECTION 2.4 PIPE FITTINGS

T and cross fittings

2.4.1.(1) A T fitting shall not be used in a *drainage system* except to connect a *vent pipe*.

(2) A cross fitting shall not be used in a *drainage system*. (See Appendix.)

2.4.2.(1) A single or double sanitary T fitting shall not be used in a *nominally horizontal soil-or-waste pipe*, except that a single sanitary T fitting may be used to connect a *vent pipe*.

(2) A single or double sanitary T fitting shall not be used to change the direction of flow in *nominally horizontal drainage piping*.

(3) Except as permitted in Article 2.4.4., a single or a double sanitary T fitting shall be used to connect a *continuous vent* to a *fixture drain*. (See Appendix.)

- 2.4.3.** The *size* of the major leg of a double Y or a double combination Y and 1/8th bend fitting used in a *nominally horizontal soil-or-waste pipe* shall be at least 2 in. (See Appendix.) Double Y fitting
- 2.4.4.** A single or double combination Y and 1/8th bend fitting may be used to connect a *fixture drain* whose *size* is more than 2 in. to a *continuous vent* or a *nominally vertical soil-or-waste pipe* that serves as the *vent pipe*. (See Appendix, diagram (b), explaining Article 2.4.2.) Combination Y and 1/8th bend
- 2.4.5.** A 1/4 bend that has a centre-line radius that is less than the *size* of the pipe shall not be used to join 2 *soil-or-waste pipes*. Quarter bend
- 2.4.6.** A *sisson fitting* shall not be installed in a *nominally horizontal soil-or-waste pipe*. Sisson fitting

SUBSECTION 2.5 NON-METALLIC PIPE AND FITTINGS

(For a summary of pipe applications see Appendix.)

- 2.5.1.(1)** Asbestos-cement drainage pipe, couplings and fittings shall conform to Asbestos-cement drainage pipe and fittings
- (a) CGSB 34-GP-9d (1972), "Pipe, Sewer, Asbestos Cement,"
 - (b) CGSB 34-GP-22b (1973), "Pipe, Drain Asbestos Cement," or
 - (c) CGSB 34-GP-23 (1972), "Pipe, Sewer, Asbestos Cement, House Connection."
- (2) Except as provided in Sentence (3), asbestos-cement drainage pipe shall not be used except for the underground part of a *drainage system*.
- (3) Asbestos-cement drainage pipe conforming to CGSB 34-GP-22b (1973), "Pipe, Drain Asbestos Cement," may be used
- (a) in a *sanitary drainage system*
 - (i) in a crawl space next to the ground, or
 - (ii) in a non-habitable area when *approved*, or
 - (b) in a *storm drainage system*.
- 2.5.2.(1)** Asbestos-cement water pipe, couplings and bends shall conform to CGSB 34-GP-1b (1969), "Pipe, Asbestos Cement, Pressure." Asbestos-cement water pipe and fittings
- (2) Asbestos-cement water pipe shall not be used above ground.
- 2.5.3.(1)** Bituminized-fibre pipe, couplings and bends shall conform to CGSB 56-GP-1b (1970), "Pipe: Bituminized Fibre, Drain and Sewer."
- (2) Bituminized-fibre pipe, couplings and bend shall not be used except
- (a) underground outside a *building* in a *storm drainage system*, when *approved*, or
 - (b) in a *building sewer* serving 1 or 2 *dwelling units*, when *approved*.
- 2.5.4.(1)** Concrete pipe and fittings shall conform to "standard strength non-reinforced" concrete sewer pipe as specified in ASTM C14-71 "Concrete Sewer, Storm Drain and Culvert Pipe." Concrete pipe and fittings
- (2) Concrete pipe fittings fabricated from lengths of pipe are prohibited.
- (3) Concrete pipe and fittings shall not be used in or under a *building*.
- 2.5.5.(1)** Vitrified clay pipe and fittings shall conform to CSA A60.1-1969, "Vitrified Clay Pipe."
- (2) Couplings and joints for vitrified clay pipe shall conform to CSA A60.3-1969, "Vitrified Clay Pipe Joints."

Plastic pipe and fittings

(3) Vitrified clay pipe and fittings shall not be used except for an underground part of a *drainage system*.

2.5.6.(1) Polyethylene water pipe shall conform to CSA B137.1-1970, "Polyethylene Pipe for Cold Water Services."

(2) Polyethylene water pipe shall not be used except for a *water service pipe*.

(3) Insert fittings for use with polyethylene pipe shall conform to ASTM D2609-73, "Plastic Insert Fittings for Polyethylene (PE) Plastic Pipe."

(4) Butt fusion fittings for polyethylene pipe shall conform to ASTM D2610-73, "Butt Fusion Polyethylene (PE) Plastic Pipe Fittings, Schedule 40," or ASTM D2611-73, "Butt Fusion Polyethylene (PE) Plastic Pipe Fittings, Schedule 80."

2.5.7.(1) PVC water pipe shall conform to CSA B137.3-1972, "Rigid Poly (Vinyl Chloride) (PVC) Pipe for Pressure Applications."

(2) PVC water pipe fittings shall conform to ASTM D2466-73, "Socket Type Poly (Vinyl Chloride) (PVC) Plastic Pipe Fittings, Schedule 40" or ASTM D2467-73, "Socket Type Poly (Vinyl Chloride) (PVC) Plastic Pipe Fittings, Schedule 80."

(3) PVC solvent cements shall conform to ASTM D2564-73a, "Solvent Cements for Poly (Vinyl Chloride) (PVC) Plastic Pipe and Fittings."

(4) PVC water pipe and fittings in Sentences (1) and (2) shall not be used in a hot water system.

2.5.8.(1) CPVC hot and cold water pipe, fittings and solvent cements shall conform to CSA B137.6-1971, "Chlorinated Poly (Vinyl Chloride) (CPVC) Plastic Piping for Hot and Cold Water Distribution Systems."

(2) CPVC pipe and fittings shall not be used in a system where the design water temperature may exceed 180°F (82°C) or the design pressure may exceed 100 psi (690 kN/m²).

2.5.9.(1) Plastic pipe, fittings and solvent cement used underground outside a *building* in a *drainage system* shall conform to

- (a) CSA B181.1-1973, "Acrylonitrile-Butadiene-Styrene Drain, Waste and Vent (ABS-DWV) Pipe and Pipe Fittings,"
- (b) CSA B181.2-1973, "Poly (Vinyl Chloride) Drain, Waste and Vent Pipe and Pipe Fittings," or
- (c) CSA B182.1-1967, "Plastic Drain and Sewer Pipe and Pipe Fittings for Use Underground."

2.5.10.(1) Plastic pipe, fittings and solvent cement used inside or under a *building* in a *drainage* or *venting system* shall conform to

- (a) CSA B181.1-1973, "Acrylonitrile-Butadiene-Styrene Drain, Waste and Vent (ABS-DWV) Pipe and Pipe Fittings," or
- (b) CSA B181.2-1973, "Poly (Vinyl Chloride) Drain, Waste and Vent Pipe and Pipe Fittings."

(2) Requirements for *combustible* piping in relation to fire safety shall conform to Sentence 3.1.4.5.(5) and Article 3.1.7.7. of Part 3 and Articles 9.10.9.10. and 9.10.9.26. of Part 9 of the National Building Code of Canada 1975.

(3) Where *noncombustible* piping pierces a *fire separation* or a *fire stop*, the requirements for fire stopping of Article 3.1.9.1. of Part 3 and Articles 9.10.9.9. and 9.10.16.7. of Part 9 of the National Building Code of Canada 1975 shall apply.

SUBSECTION 2.6 FERROUS PIPE AND FITTINGS

(For summary of pipe applications see Appendix.)

- 2.6.1.(1)** Drainage piping, vent piping and fittings made of cast iron shall conform to CSA B70-1974, "Cast Iron Soil Pipe and Fittings and Methods of Joining." Cast-iron soil pipe and fittings
- (2) Cast-iron soil pipe and fittings shall not be used in a *water system*.
- 2.6.2.** Cast-iron fittings designed for use with asbestos-cement pipe for drainage purposes shall conform to the applicable requirements of CSA B70-1974, "Cast Iron Soil Pipe and Fittings and Methods of Joining."
- 2.6.3.(1)** Threaded cast-iron drainage fittings shall conform to ANSI B16.12-1971, "Cast Iron Threaded Drainage Fittings." Threaded cast-iron drainage fittings
- (2) Threaded cast-iron drainage fittings shall not be used in a *water system*.
- 2.6.4.(1)** Cast-iron water pipe shall conform to Cast-iron water pipe
- (a) CSA B131.5-1973, "Cast-Iron Pipe Centrifugally Cast in Metal Molds, for Water or Other Liquids,"
- (b) CSA B131.11-1958, "Universal Cast Iron Pipe and Fittings Cast in Sand-Lined Molds for Water and Other Liquids," or
- (c) CSA B131.13-1973, "Ductile-Iron Pipe, Centrifugally Cast in Metal Molds or Sand-Lined Molds for Water or Other Liquids."
- (2) Cement mortar lining for cast-iron water pipe shall conform to CSA B131.4-1973, "Cement-Mortar Lining for Cast-Iron Pipe and Fittings for Water."
- (3) Cast-iron fittings for cast-iron water pipe shall conform to CSA B131.9-1974, "Gray-Iron and Ductile-Iron Fittings, 2 Inches Through 48 Inches for Water and Other Liquids" and Supplement B131.9a-1974.
- (4) Rubber gasket joints for cast-iron and ductile-iron pressure pipe for water piping shall conform to CSA B131.10-1973, "Rubber-Gasket Joints for Cast-Iron and Ductile-Iron Pressure Pipe and Fittings."
- 2.6.5.(1)** Screwed cast-iron water fittings shall conform to ANSI B16.4-1971, "Cast Iron Screwed Fittings, 125 and 250 lb." Cast-iron screwed water fittings
- (2) Screwed cast-iron water fittings used in a *water system* shall be cement lined or galvanized.
- (3) Screwed cast-iron water fittings shall not be used in a *drainage system*.
- 2.6.6.(1)** Screwed malleable iron water fittings shall conform to ANSI B16.3-1971, "Malleable Iron Screwed Fittings 150 and 300 lb." Malleable iron screwed water fittings
- (2) Screwed malleable iron water fittings used in a *water system* shall be cement lined or galvanized.
- (3) Screwed malleable iron water fittings shall not be used in a *drainage system*.
- 2.6.7.(1)** Except as provided in Sentences (2) and (3), welded and seamless steel pipe shall not be used in a *plumbing system*. Steel pipe
- (2) Galvanized steel pipe may be used in a *drainage system* or a *venting system* above ground inside a *building*.
- (3) Galvanized steel pipe may be used in a *water distribution system* where *approved*.

(4) Galvanized steel pipe shall conform to CSA B63-1966, "Welded and Seamless Steel Pipe."

Corrugated steel pipe

2.6.8.(1) Corrugated steel pipe and couplings shall be made from material conforming to ASTM A444-71, "Steel Sheet Zinc Coated (Galvanized) by the Hot Dip Process."

(2) Corrugated steel pipe shall only be used underground outside a *building* in a *storm drainage system*.

(3) Couplings for corrugated steel pipe shall be constructed so that when installed they shall

- (a) maintain the pipe alignment,
- (b) resist the separation of adjoining lengths of pipe,
- (c) prevent root penetration, and
- (d) prevent the infiltration of surrounding material.

Sheet metal leader

2.6.9. A sheet metal *leader* shall not be used except above ground outside a *building*.

SUBSECTION 2.7 NON-FERROUS PIPE AND FITTINGS

(For summary of pipe applications see Appendix.)

Copper and brass pipe

2.7.1. Copper and brass pipe shall conform to CSA HC.7.5-1968, "Seamless Copper and Red Brass Pipe."

Brass or bronze flanges and flanged fittings

2.7.2. Brass or bronze pipe flanges and flanged fittings shall conform to ANSI B16.24-1971, "Bronze Flanges and Flange Fittings, 150 and 300 lb."

Brass or bronze threaded water fittings

2.7.3.(1) Brass or bronze threaded water fittings shall conform to ANSI B16.15-1971, "Cast Bronze Threaded Fittings, 150 and 300 lb."

(2) Brass or bronze threaded water fittings shall not be used in a *drainage system*.

2.7.4.(1) Copper tube shall conform to

- (a) CSA HC.7.6-1968, "Seamless Copper Water Tube, Drainage Tube (DWV) and Hydronic Heating Tube (Type H),"
- (b) ASTM B88-72, "Seamless Copper Water Tube," or
- (c) ASTM B306-73, "Copper Drainage Tube (DWV)."

(2) The use of copper tube shall conform to Table 2.7.A.

Table 2.7.A.

Forming Part of Article 2.7.4.

Type of Copper Tube	PLUMBING PURPOSES							
	Water Service Pipe	Water Distribution System		Building Sewer	Drainage System		Venting System	
		Under-ground	Above-ground		Under-ground	Above-ground	Under-ground	Above-ground
K & L hard	P	P	P	P	P	P	P	P
K & L soft	P	P	P	N	N	N	N	N
M	N	N	P	N	N	P	N	P
DWV	N	N	N	N	N	P	N	P
Column 1	2	3	4	5	6	7	8	9

P—Permitted N—Not Permitted

2.7.5.(1) Solder-joint fittings for *drainage systems* shall conform to

- (a) ANSI B16.23-1969, "Cast Bronze Solder Joint Drainage Fittings—DWV," or
- (b) ANSI B16.29-1966, "Wrought Copper and Wrought Copper Alloy Solder-Joint Drainage Fittings."

Solder-joint drainage fittings

(2) Solder-joint fittings for *drainage systems* shall not be used in a *water system*.

2.7.6.(1) Except as provided in Sentence (2), solder-joint fittings for *water systems* shall conform to

Solder-joint water fittings

- (a) ANSI B16.18-1972, "Cast Bronze Solder-Joint Pressure Fittings," or
- (b) ANSI B16.22-1973, "Wrought Copper and Bronze Solder-Joint Pressure Fittings."

(2) Solder-joint fittings for *water systems* not made by casting or the wrought process shall conform to the applicable requirements of ANSI B16.18-1972, "Cast Bronze Solder-Joint Pressure Fittings."

2.7.7.(1) Flared-joint fittings for *water systems* shall conform to ANSI B16.26-1967, "Cast Bronze Fittings for Flared Copper Tubes."

Flared-joint water fittings

(2) Flared-joint fittings for *water systems* not made by casting shall conform to the applicable requirements of ANSI B16.26-1967, "Cast Bronze Fittings for Flared Copper Tubes."

2.7.8.(1) Lead *waste pipe* and fittings shall conform to CSA B67-1972, "Lead Service Pipe, Waste Pipe, Traps, Bends and Accessories."

Lead waste pipe and bends

(2) When there is a change in *size* of a lead closet bend, the change shall be in the vertical section of the bend or made in such a manner that there shall be no retention of liquid in the bend.

(3) Lead *waste pipe* and fittings shall not be used in a *water system* or for a *building sewer*.

SUBSECTION 2.8 JOINTING MATERIALS

- Cement jointing mortar **2.8.1.** Cement mortar for jointing shall be a mixture of equal parts of clean, sharp mortar sand and portland cement.
- 2.8.2.** Cold caulking compounds shall conform to CGSB 77-GP-1a(1970), "Caulking Compound: Cementitious Type, Cold Applied, for Pipe Joints."
- Solder and caulking lead **2.8.3.(1)** Wiping solder and caulking lead shall conform to CSA B67-1972, "Lead Service Pipe, Waste Pipe, Traps, Bends and Accessories."
- (2) Solders for solder joint fittings shall conform to ASTM B32-70, "Solder Metal" in accordance with the recommended use.

SUBSECTION 2.9 MISCELLANEOUS MATERIALS

- Brass floor flanges **2.9.1.** Brass floor flanges shall conform to ANSI B16.23-1969, "Cast Bronze Solder-Joint Drainage Fittings DWV."
- Bolts, nuts, etc. **2.9.2.(1)** Every screw, bolt, nut and washer shall be of brass when used
- (a) to connect a water closet to a water closet flange,
 - (b) to anchor the water closet flange to the floor, or
 - (c) to anchor the water closet to the floor.
- Cleanout fittings **2.9.3.(1)** Every plug, cap, nut or bolt that is intended to be removable from a ferrous fitting shall be of an *approved* non-ferrous material.
- (2) A *cleanout* fitting that as a result of normal maintenance operations cannot withstand the physical stresses of removal and reinstallation or cannot ensure a gas-tight seal shall not be installed.
- 2.9.4.(1)** Groove and shoulder type mechanical pipe couplings shall conform to CSA B242-1971, "Groove and Shoulder Type Mechanical Pipe Couplings."
- (2) Groove and shoulder type mechanical pipe couplings shall be provided with an elastomeric seal and shall be housed with a metal clamp which shall interlock with a groove or shoulder on the pipe ends.
- Saddle hub **2.9.5.(1)** A saddle hub shall not be installed in a *drainage system* or *venting system*.
- (2) A saddle hub shall not be installed in a *water system* unless *approved*.
- Supply and waste fittings **2.9.6.** Supply and waste fittings shall conform to CSA B125-1967, "Plumbing Fittings."
- Direct flush valve **2.9.7.(1)** Every direct flush valve shall
- (a) open fully and close positively under service pressure,
 - (b) complete its cycle of operation automatically,
 - (c) be provided with a means of regulating the volume of water that it discharges, and
 - (d) be provided with a *vacuum breaker*.
- Drinking fountain bubblers **2.9.8.(1)** The orifice of every drinking fountain bubbler shall
- (a) be of the shielded type, and
 - (b) direct the water upward at an angle of approximately 45 deg.
- (2) Every drinking fountain bubbler shall include a means of regulating the flow to the orifice.
- (3) Bubblers shall be installed only on drinking fountains except when otherwise *approved*.

2.9.9. *Back-siphonage preventers* shall be constructed to conform to ANSI A40.6-1943, "Backflow Preventers in Plumbing Systems."

Back-siphonage preventer

2.9.10. Temperature relief, pressure relief or combined temperature and pressure relief valves shall conform to ANSI Z21.22-1971, "Relief Valves and Automatic Gas Shutoff Devices for Hot Water Supply Systems."

Relief valves

2.9.11.(1) Flashing for *vent pipes* shall be of copper, aluminum, *alloyed zinc*, lead or polychloroprene (neoprene).

Vent pipe flashings

(2) Except as provided in Sentence (3), *vent pipe* flashing shall be rectangular and at least 20 in. (0.51 m) in length by 20 in. (0.51 m) in width and, where sleeve flashing is used, the sleeve shall be extended at least 6 in. (0.15 m) above the roof at every point of the pipe or stack.

(3) On flat roofs a round *vent pipe* flashing with a flange of at least 4 in. (0.13 m) may be used.

(4) *Vent pipe* flashing shall consist of

- (a) lead sheet at least 0.085 in. (2.16 mm) thick,
- (b) copper sheet at least 0.013 in. (0.33 mm) thick,
- (c) sheet aluminum at least 0.024 in. (0.61 mm) thick,
- (d) alloyed zinc sheet at least 0.014 in. (0.35 mm) thick, or
- (e) polychloroprene (neoprene) at least 0.114 in. (2.89 mm) thick.

(See Article 5.5.5. for location of vent pipe terminals.)

SECTION 3 PIPING

SUBSECTION 3.1 APPLICATION

3.1.1. This Section applies to the construction and use of joints and connections, and the arrangement, protection, support and testing of piping.

SUBSECTION 3.2 CONSTRUCTION AND USE OF JOINTS

3.2.1.(1) Every caulked lead drainage joint shall be firmly packed with oakum and tightly caulked with lead to a depth of at least 1 in. (25 mm).

Caulked lead drainage joints

(2) No paint, varnish or other coating shall be applied on the lead until after the joint has been tested.

(3) Caulked lead drainage joints shall not be used except for cast-iron pipe in a *drainage system* or *venting system*, or between such pipe and

- (a) other ferrous pipe,
- (b) brass and copper pipe,
- (c) a caulking ferrule, or
- (d) a *trap standard*.

(4) A length of hub and spigot pipe and pipe fittings in a *plumbing system* shall be installed with the hub at the upstream end.

3.2.2.(1) Wiped joints shall not be used except for sheet lead or lead pipe, or between such pipe and copper pipe or a ferrule.

(2) Every wiped joint in straight pipe shall

- (a) be made of solder,
- (b) have an exposed surface on each side of the joint at least $\frac{3}{4}$ in. (19 mm) wide, and
- (c) be at least $\frac{3}{8}$ in. (10 mm) thick at the thickest part.

- (3) Every wiped flanged joint shall be reinforced with a lead flange that is at least $\frac{3}{4}$ in. (19 mm) wide.
- Screwed joints **3.2.3.(1)** In making a screwed joint the ends of the pipe shall be reamed or filed out to the size of the bore and all chips and cuttings shall be removed.
- (2) No pipe-joint cement or paint shall be applied to the internal threads.
- Soldered joints **3.2.4.(1)** In making a soldered joint the surface to be soldered shall be cleaned bright and the joint shall be properly fluxed, made with solder and thoroughly cleaned of all residue.
- Flared joints **3.2.5.(1)** In making a flared joint the pipe shall be expanded with a proper flaring tool.
- (2) Flared joints shall not be used for hard (drawn) copper tube.
- Hot-poured joints **3.2.6.(1)** Hot-poured joints shall be caulked tightly with twisted oakum and rammed, and a hot-poured caulking compound shall be placed to a depth of at least 1 in. (25 mm) all around the pipe.
- (2) Hot-poured joints shall not be used except for vitrified clay or concrete pipe, or between either of such pipes and ferrous pipe.
- Cement joints **3.2.7.(1)** Cement joints in pipe that has a *size* of 6 in. or less shall be made by completely filling the annular space between the bell and the spigot with cement mortar.
- (2) Every cement joint in pipe that has a *size* of more than 6 in. shall be made by
- ramming into the annular space between the bell and the spigot a gasket of closely twisted hemp or oakum at least equal in length to the circumference of the pipe, and
 - filling the remaining annular space with mortar.
- (3) The exterior of every cement joint shall be carefully shaped from the outside of the bell to the barrel of the pipe at an angle of approximately 45 deg.
- (4) After every joint is made the interior of the pipe shall be thoroughly swabbed and cleaned.
- (5) Cement joints shall not be used except for vitrified clay or concrete pipe or between either of such pipes and ferrous pipe.
- Burned lead joints **3.2.8.(1)** In making a burned lead joint the lead shall be lapped and fused to form a weld that is at least $1\frac{1}{2}$ times as thick as the wall of the pipe.
- (2) In lead pipe the width of the weld shall be at least
- $\frac{1}{2}$ in. (13 mm) where the *size* of the pipe is less than 3 in.,
 - $\frac{3}{8}$ in. (16 mm) where the *size* of the pipe is 3 in., or
 - $\frac{3}{4}$ in. (19 mm) where the *size* of the pipe is 4 in.
- (3) In sheet lead the width of the weld shall be as specified in Table 3.2.A.

Table 3.2.A.
Forming Part of Sentence 3.2.8.(3)

Weight of Sheet Lead, lb/sq ft	Minimum Width of Weld, in.
2½ to 3	¼
4 to 5	⅜
6 to 8	¾
10 to 12	1
12 to 30	1¼
Column 1	2

3.2.9. Mechanical joints shall be made with *approved* compounded elastomeric couplings or rings held by stainless steel or cast-iron clamps or contained within a compression connection or groove and shoulder type mechanical coupling.

Mechanical joints

3.2.10.(1) Cold-caulked joints shall not be used except for bell and spigot pipe in a *water system* or a *drainage system*. The caulking compound shall be applied according to the manufacturer's directions.

Cold caulked joints

(2) Every cold-caulked joint in a *drainage system* shall be firmly packed with oakum and tightly caulked with cold caulking compound to a depth of at least 1 in. (25 mm).

(3) Every cold-caulked joint in a *water system* shall be made by tightly caulking the entire depth of the socket with caulking compound.

SUBSECTION 3.3 JOINTS AND CONNECTIONS

3.3.1. Drilled and tapped joints shall not be made in a *soil-or-waste pipe* and *vent pipe* and fittings unless suitable provision has been provided for drilling and tapping.

Drilled and tapped

3.3.2.(1) Cast-iron soil pipe and fittings shall not be welded.

Welded joints

(2) Galvanized steel pipe and fittings shall not be welded.

3.3.3.(1) Running thread and packing nut connections and unions with a gasket seal shall not be used downstream of a *trap weir* in a *drainage system* or in a *venting system*.

Unions and slip joints

(2) A slip joint shall not be used

(a) in a *venting system*, or

(b) in a *drainage system*, except to connect a *fixture trap* to a *fixture drain* in an accessible location. (See Appendix explaining Sentences 2.3.1.(1). and 2.3.1.(2).)

3.3.4. Every connection between 2 pipes of different *size* shall be made with an increaser or a reducer fitting installed so that it will permit the system to be completely drained.

Increaser or reducer

3.3.5. Every joint in hard lead shall be made with a burned lead joint.

Burned lead

3.3.6.(1) Adaptors, connectors or mechanical joints used to join dissimilar materials shall be designed to accommodate the required transition.

Dissimilar connections

(2) Products not meeting an *approved* standard shall not be used unless *approved*.

- (3) Other methods of joining dissimilar materials shall not be used unless *approved*.
- Connection of roof drain to leader
 Connection of floor outlet fixtures
- 3.3.7.** Every roof *drain* shall be securely connected to a *leader* and provision shall be made for expansion.
- 3.3.8.(1)** Every pedestal urinal, floor-mounted water closet or *S-trap standard* shall be connected to a *fixture drain* by a floor flange, except that a cast-iron *trap standard* may be caulked to a cast-iron pipe.
- (2) Except as provided in Sentences (3) and (4), every floor flange shall be of brass.
- (3) Where plastic pipe is used, a floor flange of the same material may be used.
- (4) Every floor flange shall be securely set on a firm base and bolted to the *trap* flange of the *fixture*, and every joint shall be sealed with a natural rubber, synthetic rubber or asbestos graphite gasket, or with a closet setting compound.
- (5) Where a lead water closet stub is used, the length of the stub below the floor flange shall be at least 3 in. (76 mm).
- 3.3.9.** The design and installation of every piping system shall, where necessary, include means to accommodate expansion and contraction of the piping system caused by temperature change or movement of the soil.
- 3.3.10.** Types M and DWV copper tube shall not be bent.
- Making indirect connections
- 3.3.11.(1)** Where a *fixture* or device is *indirectly connected*, the connection shall be made by terminating the *fixture drain* above the *flood level rim* of a *directly connected fixture* to form an *air break*.
- (2) The size of the *air break* shall at least equal the size of the *fixture drain, branch* or pipe that terminates above the *directly connected fixture*, and it shall be at least 1 in. (25 mm). (See Appendix.)
- SUBSECTION 3.4 SUPPORT OF PIPING**
- Capability of support
- 3.4.1.(1)** Piping shall be provided with support that is capable of keeping the pipe in alignment and bearing the weight of the pipe and its contents.
- (2) Every floor-mounted water-closet bowl shall be securely attached to the floor by means of a flange.
- (3) Every wall-mounted water-closet bowl shall be supported so that no strain is transmitted to the piping.
- Independence of support
- 3.4.2.** Every pipe that is connected to a *fixture*, tank or device shall be supported independently of it.
- Insulation of support
- 3.4.3.** Where a hanger or support for copper tube or brass or copper pipe is of a material other than brass or copper, it shall be suitably separated and electrically insulated from the pipe.
- Support for vertical piping
- 3.4.4.(1)** Except as provided in Sentences (2) and (3), vertical piping shall be supported at its base and at the floor level of alternate *storeys* by metal rests, each of which can bear the weight of pipe that is between it and the metal rest above it.
- (2) The maximum spacing of supports shall be 25 ft (7.6 m).
- (3) Where hub and spigot cast-iron pipe is used, each hub shall rest on a support.

3.4.5.(1) *Nominally horizontal* piping that is inside a *building* shall be braced to prevent swaying and buckling and to control the effects of thrust.

Support for horizontal piping

- (2) *Nominally horizontal* piping shall be supported so that
- (a) galvanized iron or steel pipe and copper pipe is supported at intervals not exceeding
 - (i) 12 ft (3.7 m) if the pipe *size* is 6 in. or more, and
 - (ii) 8 ft (2.4 m) if the pipe *size* is less than 6 in.,
 - (b) lead pipe is supported throughout its length,
 - (c) cast-iron pipe is supported
 - (i) at or adjacent to each hub or joint,
 - (ii) at intervals not exceeding 5 ft (1.5 m), and
 - (iii) at intervals not exceeding 3 ft (0.91 m) if the pipe has mechanical joints and the length of pipe between adjacent fittings is 12 in. (305 mm) or less,
 - (d) asbestos-cement pipe is supported
 - (i) adjacent to each joint,
 - (ii) at intervals not exceeding 6½ ft (2.0 m), and
 - (iii) at intervals not exceeding 3 ft (0.91 m) where the length of pipe between adjacent fittings is 12 in. (305 mm) or less,
 - (e) ABS or PVC plastic pipe is supported
 - (i) at intervals not exceeding 4 ft (1.2 m),
 - (ii) at the ends of *branches*,
 - (iii) at changes of direction or elevation, and
 - (iv) if the pipe is a *fixture drain* that is more than 3 ft (0.91 m) in length, as close as possible to the *trap*, and
 - (f) CPVC plastic pipe is supported at intervals not exceeding 3 ft (0.91 m).
- (3) Where PVC, CPVC or ABS plastic pipe is installed
- (a) the pipe shall be aligned without added strain on the piping,
 - (b) the pipe shall not be bent or pulled into position after being welded, and
 - (c) hangers shall not compress, cut or abrade the pipe.
- (4) Where hangers are used to support *nominally horizontal* piping they shall be
- (a) metal rods of at least ⅜ in. (10 mm) diameter for pipe over 4 in. in *size*, and
 - (b) solid or perforated metal strap hangers for pipe 4 in. or less in *size*.
- (5) Where a hanger is attached to concrete or masonry, it shall be fastened by metal or expansion-type plugs that are inserted or built into the concrete or masonry.

3.4.6. *Nominally horizontal* piping that is underground shall be supported on a base that is firm and continuous under the whole of the pipe. (See Appendix.)

Support for underground horizontal piping

3.4.7. Where a *vent pipe* terminates above the surface of a roof it shall be supported or braced to prevent misalignment.

Support of vent pipe above roof

(See Article 5.5.5. for location of vent pipe terminals.)

SUBSECTION 3.5 PROTECTION OF PIPING

3.5.1. Where piping is installed underground, the backfill shall be carefully placed and tamped to a height of 12 in. (305 mm) over the top of the pipe and shall be free of stones, boulders, cinders and frozen earth. (See Appendix.)

Backfill

3.5.2. Where asbestos-cement drainage pipe or vitrified clay pipe is located less than 2 ft (0.61 m) below a basement floor and the floor is constructed of other than 3 in. (76 mm) or more of concrete, the pipe shall be protected by a 3-in. (76 mm) layer of concrete installed above the pipe. (See Appendix.)

Protection of non-metallic pipes

Isolation from loads **3.5.3.** Where piping passes through or under a wall it shall be installed so that the wall does not bear on the pipe.

Protection from frost **3.5.4.** Where piping may be exposed to freezing conditions it shall be protected from frost.

3.5.5. Plumbing, piping and equipment exposed to mechanical damage shall be protected.

SUBSECTION 3.6 TESTING OF DRAINAGE AND VENTING SYSTEMS

3.6.1.(1) Except in the case of an external *leader*, after a section of a *drainage system* or a *venting system* has been roughed in and before any *fixture* is installed or piping is covered, a water or an air test shall be conducted to the satisfaction of the *authority having jurisdiction*.

(2) After every *fixture* is installed and before any part of the *drainage system* or *venting system* is placed in operation, a smoke test shall be carried out when requested by the *authority having jurisdiction*.

(3) Where a prefabricated system is installed as part of a *drainage* and *venting system* and has been *approved*, all other plumbing work shall be tested and inspected and a smoke test shall be carried out on the complete system when requested by the *authority having jurisdiction*.

(4) When requested by the *authority having jurisdiction*, a ball test shall be made to any pipe in a *drainage system*.

(See Subsection 1.9 for additional requirements for inspection and testing.)

Tests of drainage system **3.6.2.(1)** Every pipe in a *drainage system*, except an external *leader* or *fixture outlet pipe*, shall be capable of withstanding without leakage a water test, air test or smoke test.

(2) Every pipe in a *drainage system* shall be capable of meeting a ball test.

Tests of venting system **3.6.3.** Every *venting system* shall be capable of withstanding without leakage a water test, air test or smoke test.

Water test **3.6.4.(1)** Where a water test is made it shall be applied to
 (a) the system as a whole, or
 (b) sections of the system, each of which is at least 10 ft (3.0 m) high and includes at least 5 ft (1.5 m) of the section below.

(2) In making a water test

- (a) every opening except the highest shall be tightly closed with a testing plug or a screw cap, and
- (b) the system or the section shall be kept filled with water for 15 min.

Air test **3.6.5.(1)** Where an air test is made
 (a) every opening in the system shall be closed,
 (b) air shall be forced into the system until a pressure of 5 psi (34.5 kN/m²) is created, and
 (c) this pressure shall be maintained for 15 min. without the addition of more air.

Smoke test **3.6.6.(1)** Where a smoke test is made
 (a) every *trap* shall be filled with water,
 (b) smoke from 1 or more smoke machines shall be forced into the system,
 (c) when the smoke appears from all roof terminals they shall be closed, and
 (d) a pressure equivalent to a 1-in. (25 mm) water column shall be built up and maintained for 15 min.

3.6.7.(1) Where a ball test is made, a hard ball dense enough not to float shall be rolled through the pipe. Ball test

- (2) The diameter of the ball shall be
 - (a) 2 in. (51 mm) where the *size* of the pipe is 3 in. or more, or
 - (b) 1 in. (25 mm) where the *size* of the pipe is less than 3 in.

SUBSECTION 3.7 TESTING OF POTABLE WATER SYSTEMS

(See Subsection 1.9 for additional requirements for inspection and testing.)

3.7.1.(1) After a section of a *potable water system* has been completed and before it is placed in operation, a water test shall be conducted to the satisfaction of the *authority having jurisdiction*, except that an air test may be used in freezing conditions. Application of tests

(2) A test may be applied to each section of the system or to the system as a whole.

(3) Where a prefabricated system is installed as part of a *water system* and has been *approved*, all other plumbing work shall be tested and inspected and the complete system shall be pressure tested when requested by the *authority having jurisdiction*.

3.7.2.(1) Every *potable water system* shall be capable of Tests of water systems

- (a) withstanding without leakage a water pressure that is at least equal to the maximum pressure to which it may be subject in service, or
- (b) withstanding for at least 2 hr without a drop in pressure an air pressure that is at least 100 psi (690 kN/m²).

3.7.3.(1) Where a water test is made all air shall be expelled from the system before *fixture* control valves or faucets are closed. Water tests

- (2) *Potable water* shall be used to test a *potable water system*.

SECTION 4 DRAINAGE SYSTEMS

SUBSECTION 4.1 APPLICATION

4.1.1. This Section applies to a *sanitary drainage system*, a *storm drainage system*, a *combined building drain* or a *combined building sewer*.

SUBSECTION 4.2 CONNECTIONS TO DRAINAGE SYSTEMS

4.2.1.(1) Every *fixture* shall be *directly connected* to a *sanitary drainage system*, except that Connection to sanitary drainage systems

- (a) drinking fountains may be
 - (i) *indirectly connected* to a *sanitary drainage system*, or
 - (ii) connected to a *storm drainage system* provided that where the system is subject to *backflow*, a *check valve* is installed in the fountain waste pipe. (see Appendix),
- (b) where approved, a floor drain may be connected to a *storm drainage system* provided it is located where it can receive only *clear-water waste* or *storm water*,
- (c) *fixtures* or *appliances* that discharge only *clear-water waste* may be connected to a *storm drainage system* or be drained onto a roof,

- (d) the following devices shall be *indirectly connected to a drainage system*:
 - (i) a device for the display, storage, preparation or processing of food or drink,
 - (ii) a sterilizer,
 - (iii) a device that uses water as a cooling or heating medium,
 - (iv) a water operated device,
 - (v) a water treatment device, or
 - (vi) a drain or overflow from a *water system* or a heating system (see Appendix),
 - (e) *fixtures* that have a hydraulic load of not more than 1½ *fixture units* may be connected to a vertical section of a *circuit vent* or *relief vent* provided
 - (i) the *fixtures* are located in the same *storey* as the *fixtures* served by the *vent pipes*,
 - (ii) not more than 2 *fixtures* are connected to the *vent pipe*,
 - (iii) where 2 *fixtures* are connected to the *vent pipe*, the connection is by means of a double sanitary T fitting, and
 - (iv) the section of the *vent pipe* that becomes a *wet vent* conforms to the requirements for *wet vents*,
 - (f) *fixtures* that have a hydraulic load of not more than 1½ *fixture units* may be connected to the vertical section of a *yoke vent* provided
 - (i) not more than 2 *fixtures* are connected to the *vent pipe*,
 - (ii) where 2 *fixtures* are connected to the *vent pipe*, the connection is by means of a double sanitary T fitting, and
 - (iii) the section of the *vent pipe* that becomes a *wet vent* conforms to the requirements for *wet vents*, and (see Appendix)
 - (g) *fixtures* may be connected to a *vent stack* provided
 - (i) the total hydraulic load of the connected *fixtures* does not exceed 8 *fixture units*,
 - (ii) at least 1 *fixture* is connected to a vertical portion of the *vent stack* and upstream of any other *fixtures*,
 - (iii) no other *fixture* is connected downstream of a water closet,
 - (iv) all *fixtures* are located in the lowest *storey* served by the *vent stack*, and
 - (v) the section of the *vent pipe* that becomes a *wet vent* conforms to the requirements for *wet vents*. (See Appendix.)
- (2) The connection of a *soil-or-waste pipe* to a *nominally horizontal offset* in a *soil-or-waste stack* shall be at least 5 ft (1.5 m) in *developed length* downstream from the base of the upper vertical section of the *soil-or-waste stack* where such upper vertical section
- (a) receives a discharge of 30 or more *fixture units*, or
 - (b) receives a discharge from *fixtures* located on 2 or more *storeys*.
- (3) The connection of a *soil-or-waste pipe* to a *nominally horizontal soil-or-waste pipe* shall be at least 5 ft (1.5 m) in *developed length* downstream from the base of a *soil-or-waste stack* that
- (a) receives a discharge of 30 or more *fixture units*, or
 - (b) receives the discharge from *fixtures* located on 2 or more *storeys*.
- (4) No other *fixture* shall be connected to a lead bend or stub that serves a water closet.
- 4.2.2.** An overflow from a rainwater tank shall not be *directly connected to a drainage system*.
- 4.2.3.(1)** Two or more *fixture drains* that serve outlets from a single *fixture* that is listed in Clause 4.2.1.(1)(d) may be *directly connected to a branch* that
- (a) has a *size* of at least 1¼ in., and
 - (b) is terminated above the *flood level rim* of a *directly connected fixture* to form an *air break*.

- (2) *Fixture drains* from *fixtures* that are listed in Subclauses (i) and (ii) of Clause 4.2.1.(1)(d) may be *directly connected* to a pipe that
- (a) is terminated to form an *air break* above the *flood level rim* of a *fixture* that is *directly connected* to a *sanitary drainage system*, and
 - (b) is extended through the roof when *fixtures* that are on 3 or more *storeys* are connected to it. (See Appendix explaining Clause 4.2.1.(1)(a) and (d).)
- (3) *Fixture drains* from *fixtures* that are listed in Subclauses (iii) to (vi) of Clause 4.2.1.(1)(d) may be *directly connected* to a pipe that
- (a) is terminated to form an *air break* above the *flood level rim* of a *fixture* that is *directly connected* to a *storm drainage system*, and
 - (b) is extended through the roof when *fixtures* that are on 3 or more *storeys* are connected to it.

SUBSECTION 4.3 LOCATION OF FIXTURES

- 4.3.1. Every *fixture*, *appliance*, *interceptor*, *cleanout*, valve, device or piece of equipment shall be so located that it is readily accessible for use, cleaning and maintenance. Accessibility
- 4.3.2.(1) Every stall urinal shall be installed so that water from the urinal cannot run onto the walls or floor beneath the *fixture*. Stall urinal
- (2) A stall urinal shall not be installed adjacent to walls and floors that are pervious to water.
- 4.3.3. Indirect connections or any *trap* that may overflow shall not be located in a crawl space or any other unfrequented area. Restricted locations
- 4.3.4. Garbage grinders, potato peelers and other similar types of equipment shall not be located upstream of an *interceptor*. Garbage grinders
- 4.3.5. A floor drain or other *fixture* located in an oil transformer vault, a high voltage room or any room where flammable, dangerous or toxic chemicals are stored or handled shall not be connected to a *drainage system*.

SUBSECTION 4.4 TREATMENT OF SEWAGE AND WASTES

- 4.4.1. Where a *fixture* or equipment discharges *sewage* or waste that in the opinion of the *authority having jurisdiction* may damage or impair the *sanitary drainage system* or the functioning of a public or *private sewage disposal system*, provision shall be made for treatment of the *sewage* or waste before it is discharged to the *sanitary drainage system*. Sewage treatment
- 4.4.2. Where a *fixture* discharges *sewage* or *clear-water waste* that is at a temperature in excess of 170°F (77°C), provision shall be made for cooling of the waste to 170°F (77°C) or less before it is discharged to the *drainage system*. Cooling of hot wastes or sewage
- 4.4.3.(1) Where a *fixture* that discharges *sewage* that includes grease is located in a public kitchen or restaurant or in an institution, a grease *interceptor* shall be installed when and where required by the *authority having jurisdiction*. Grease interceptors
- (2) Where the discharge from a *fixture* may contain oil or gasoline, an oil *interceptor* shall be installed. Oil or gasoline interceptors
- (3) Where a *fixture* discharges sand, grit or similar materials, an appropriate *interceptor* shall be installed. Grit interceptors

Capacity of interceptors

(4) Every *interceptor* shall have sufficient capacity to perform the service for which it is provided.

(See Article 5.4.2. for venting requirements for oil interceptors.)

SUBSECTION 4.5 TRAPS

4.5.1.(1) Except as provided in Sentences (2), (3), (4) and (5) and in Article 4.5.2., every *fixture* shall be protected by a separate *trap*.

(2) One *trap* may protect

- (a) all the trays or compartments of a 2 or 3 compartment sink,
- (b) a 2 compartment laundry tray, or
- (c) 2 similar type single compartment *fixtures* located in the same room. (See Appendix.)

(3) One *trap* may serve a group of floor drains or shower drains, a group of washing machines or a group of laboratory sinks if the *fixtures*

- (a) are in the same room, and
- (b) are not located where they can receive food or other organic matter.

(4) An *indirectly connected fixture* that can discharge only *clear-water waste* other than a drinking fountain need not be protected by a *trap*.

(See Clause 4.2.1.(1)(d) for indirect connections.)

(5) An *interceptor* with an effective water seal of at least 1½ in. (38 mm) may serve as a *trap*. (See Appendix.)

Traps for storm drainage system

4.5.2.(1) Where a *storm drainage system* is connected to a *combined building drain*, a *combined building sewer* or a public *combined sewer*, a *trap* shall be installed between any opening in the system and the drain or sewer, except that no *trap* is required if the opening is the upper end of a *leader* that terminates

- (a) at a roof that is used only for weather protection, and
- (b) at least 3 ft (0.91 m) above or at least 12 ft (3.7 m) in any other direction from any air inlet, openable window or door, and at least 6 ft (1.8 m) from a property line. (See Appendix.)

(2) A floor drain which drains to a *storm drainage system* shall be protected by a *trap* which

- (a) is located between the floor drain and a *leader*, *storm building drain* or *storm building sewer*,
- (b) may serve all floor drains located in the same room,
- (c) need not be protected by a *vent pipe*, and
- (d) need not be provided with a *trap seal primer*.

4.5.3. Where a *subsoil drainage pipe* is connected to a *sanitary drainage system*, the connection shall be made on the upstream side of a *trap* with a *cleanout* or a trapped sump. (See Appendix.)

Location and cleanout for building traps

4.5.4.(1) Where a *building trap* is installed it shall

- (a) be provided with a *cleanout* fitting on the upstream side of and directly over the *trap*,
- (b) be located upstream of the *building cleanout*,
- (c) be located
 - (i) inside the *building* as close as practical to the place where the *building drain* leaves the *building*, or
 - (ii) outside the *building* in a manhole. (See Appendix.)

Trap seals

4.5.5. Provision shall be made for maintaining the *trap seal* of a floor drain by the use of *trap seal primer*, by using the drain as a receptacle for an *indirectly connected* drinking fountain or by equally effective means. (See Appendix.)

SUBSECTION 4.6 ARRANGEMENT OF DRAINAGE PIPING

- 4.6.1.(1) No vertical *soil-or-waste pipe* shall conduct both *sewage* and *storm water*. Separate systems
- (2) A *combined building drain* shall not be installed unless *approved* by the authority having jurisdiction. Combined building drains
- (3) There shall be no unused open ends in a *drainage system* and *dead ends* shall be so graded that water will not collect in them.
- 4.6.2.(1) A *soil-or-waste pipe* shall not be located above Location of piping
- (a) non-pressure *potable* water storage tanks,
- (b) manholes in pressure *potable* water storage tanks, or
- (c) food-handling or processing equipment.
- 4.6.3.(1) Piping that is too low to drain into a *building sewer* by gravity shall be drained to a sump or receiving tank. Sumps or tanks
- (2) Where the sump or tank receives *sewage* it shall be water and air-tight and shall be vented.
- (3) Equipment such as a pump or ejector that can lift the contents of the sump or tank and discharge it into the *building sewer* shall be installed.
- (4) Where the equipment does not operate automatically the *size* of the sump shall be sufficient to hold at least a 24-hr accumulation of liquid.
- (5) Where there is a *building trap* the discharge pipe from the equipment shall be connected to the *building drain* downstream of the *trap*.
- (6) The discharge pipe from every *sewage* sump shall be equipped with a union, a *check valve* and a shut-off valve installed in that sequence in the direction of discharge. (See Appendix.)
- 4.6.4.(1) A *backwater valve* or a gate valve shall not be installed in a *building drain* or in a *building* unless *approved*.
- (2) Except as provided in Sentences (3), (4) and (5), where a *building drain* or a *branch* may be subject to *backflow*, a gate valve or a *backwater valve* shall be installed on every *fixture drain* connected to them when the *fixture* is located below the level of the adjoining street. Protection from backflow
- (3) Where the *fixture* is a floor drain, a removable screw cap may be installed on the upstream side of the *trap*.
- (4) Where more than 1 *fixture* is located in 1 room and all are connected to the same *branch*, the gate valve or *backwater valve* may be installed on the *branch*.
- (5) A *subsoil drainage pipe* that drains into a *sanitary drainage system* that is subject to surcharge shall be connected in such a manner that *sewage* cannot back up into the *subsoil drainage pipe*. (See Appendix.)

SUBSECTION 4.7 CLEANOUTS

- 4.7.1.(1) Every *sanitary drainage system* shall be provided with *cleanouts* that will permit cleaning of the entire system. (See Appendix.) Cleanouts for sanitary drainage systems
- (2) Every *soil-or-waste stack* shall be provided with a *cleanout* fitting at the bottom of the stack or not more than 10 ft (3.0 m) upstream or downstream of the bottom of the stack and shall provided access into the base of the stack.

(3) Every *building drain* shall be provided with a *cleanout* fitting that is located as close as practical to the place where the *building drain* leaves the *building*.

(4) *Cleanouts* shall be installed so that the cumulative change in direction is not more than 90 deg. between *cleanouts* in a drip pipe from a food receptacle or a *fixture drain* serving a kitchen sink.

(5) A *sanitary building sewer* and a *combined building sewer* shall not change direction or slope between the *building* and public sewer or between *cleanouts*, except that pipes not more than 6 in. in *size* may change direction

- (a) by not more than 5 deg. every 10 ft (3.0 m), or
- (b) by the use of fittings with a cumulative change in direction of not more than 45 deg.

(6) A *cleanout* fitting shall be located immediately downstream of an oil *interceptor*.

Cleanouts for storm drainage systems

4.7.2.(1) Every *storm building sewer* that exceeds 85 ft (26 m) in length shall be provided with *cleanouts*.

(2) A *cleanout* fitting shall be provided on the upstream side and directly over every running *trap*.

Size and spacing of cleanouts

4.7.3.(1) Except as provided in Sentence (2), the *size* and spacing of *cleanouts* shall conform to Table 4.7.A.

Table 4.7.A.
Forming part of Sentence 4.7.3.(1)

Size of Sanitary Drainage Pipe, in.	Minimum Size of Cleanout, in.	Maximum Spacing, ft	
		One way Rodding	Two Way Rodding
2½ or less	Same size as drainage pipe	25	50
3 and 4	3	50	100
over 4	4	85	170
Column 1	2	3	4

(2) The maximum spacing of manholes serving drainage piping larger than 4 in. in *size* shall be 300 ft (91.5 m).

(3) *Cleanouts* capable of rodding in 1 direction only shall be installed to rod in the direction of flow.

Location of cleanouts

4.7.4.(1) *Cleanouts* and access covers shall be located so that the openings are readily accessible for rodding and cleaning purposes.

(2) A *cleanout* shall not be located in a floor assembly in a manner that may constitute a hazard and shall not be used as a floor drain.

(3) There shall be no change of direction between a *cleanout* fitting and the *trap* that it serves.

(4) The piping between a *cleanout* fitting and the drainage piping or vent piping that it serves shall not change direction by more than 45 deg. unless *approved*.

SUBSECTION 4.8 MINIMUM SLOPE AND LENGTH OF DRAINAGE PIPES

4.8.1. Except as provided in Articles 4.10.8. and 4.10.9., every drainage pipe that has a *size* of 3 in. or less, and every *fixture drain* shall have a downward slope in the direction of flow of at least ¼ in./ft. (21 mm/m). (See Appendix.)

Minimum slope

4.8.2. The *developed length* of every *fixture outlet pipe* shall not exceed 3 ft (0.91 m). (See Appendix explaining Sentence 4.5.1.(2).)

Length of
fixture outlet
pipes

SUBSECTION 4.9 SIZE OF DRAINAGE PIPES

4.9.1.(1) A *soil-or-waste pipe* shall be of a *size* not less than the *size* of

- (a) a *vent pipe* that is connected to it, or
- (b) the largest *soil-or-waste pipe* that drains into it.

No reduction in
size

4.9.2.(1) The *size* of every drainage pipe that serves a water closet shall be at least 3 in.

Serving water
closets

(2) The *size* of every *branch* or *building drain* downstream of the third water closet *fixture drain* connection shall be at least 4 in. when it has 3 or more water closet *fixture drains* *directly connected* to it.

(3) The *size* of every *soil-or-waste stack* that serves more than 6 water closets shall be at least 4 in.

4.9.3.(1) Except as provided in Sentences (2) and (3), the *size* of every *fixture outlet pipe* shall conform to Table 4.9.A.

(2) The part of the *fixture outlet pipe* that is common to 3 compartments of a sink shall be 1 *size* larger than the largest *fixture outlet pipe* of the compartments that it serves. (See Appendix.)

(3) The *size* of every *fixture outlet pipe* not listed in Table 4.9.A. shall be *approved*.

Table 4.9.A.
Forming Part of Sentences 4.9.3.(1)
and 4.10.2.(1)

<i>Fixture</i>	<i>Min. Size of Fixture Outlet Pipe, in.</i>	<i>Hydraulic Load, fixture units</i>
Autopsy table	1½	2
Bathroom group		
(a) with flush tank		6
(b) with flush valve		8
Bathtub (with or without shower)	1½	1½
Bath: foot, sitz or slab	1½	1½
Beer cabinet	1½	1½
Bidet	1¼	1
Clothes washer	1½	2
Dental unit or cuspidor	1¼	1
Dishwasher		
(a) domestic type	1½	1½ { no load when connected to garbage grinder or domestic sink
(b) commercial type	2	
Drinking fountain	1¼	1
Floor drain	2	2 with 2 in. trap 3 with 3 in. trap
Garbage grinder, commercial type	2	3
Icebox	1¼	1
Laundry tray		
(a) single or double units or 2 single units with common trap	1½	1½
(b) 3 compartments	1½	2
Lavatory		
(a) barber or beauty parlor	1½	1½
(b) dental	1¼	1
(c) domestic type, single or 2 single with common trap	1¼	1 with 1¼ in. trap 1½ with 1½ in. trap according to Table 4.10.A.
(d) multiple or industrial type	1½	
Potato peeler	2	3
Shower drain		
(a) from 1 head	1½	1½
(b) from 2 or 3 heads	2	3
(c) from 4 to 6 heads	3	6
Column 1	2	3

Table 4.9.A. (Cont'd)

Forming Part of Sentences 4.9.3.(1)
and 4.10.2.(1)

<i>Fixture</i>	<i>Min. Size of Fixture Outlet Pipe, in.</i>	<i>Hydraulic Load, fixture units</i>
Sink		
(a) domestic and other small types with or without garbage grinders, single, double or 2 single with a common trap	1½	1½
(b) service type and large commercial	2	{ 2 with 2 in. trap 3 with 3 in. trap
Urinal		
(a) pedestal, siphon-jet or blowout type	2	4
(b) stall, washout type	2	2
(c) wall, lip type		
(i) washout type	1½	1½
(ii) other types	2	3
Water closet		
(a) with flush tank	3	4
(b) with flush valve	3	6
Column 1	2	3

SUBSECTION 4.10 HYDRAULIC LOADS

(See Appendix for determination of hydraulic loads and drainage pipe sizes.)

4.10.1.(1) The hydraulic load on a pipe is the total load from

Total loads

- (a) every *fixture* that is connected to the system upstream of the pipe,
- (b) every *fixture* for which provision is made for future connection upstream of the pipe, and
- (c) all roofs and paved surfaces that drain into the system upstream of the pipe.

4.10.2.(1) The hydraulic load from a *fixture* that is listed in Table 4.9.A. is the number of *fixture units* set forth in the Table.

Hydraulic loads from fixtures

(2) Except as provided in Sentence (1), the hydraulic load from a *fixture* that is not listed in Table 4.9.A. is the number of *fixture units* set forth in Table 4.10.A. for the *trap* of the size that serves the *fixture*.

Hydraulic loads from fixtures not in Table 4.9.A.

Table 4.10.A.
Forming Part of Sentence 4.10.2.(2)

Size of Trap, in.	Hydraulic Load, <i>fixture units</i>
1¼	1
1½	2
2	3
2½	4
3	5
4	6
Column 1	2

Hydraulic loads from fixtures with continuous flows

4.10.3.(1) Except as provided in Sentence (2), the hydraulic load from a *fixture* that produces a continuous or semi-continuous flow such as a pump or an air-conditioning *fixture* is 2 *fixture units* for each gpm (0.44 *fixture units* for each litre per minute) of flow.

(2) Where a *fixture* or equipment that produces a continuous or semi-continuous flow drains to a *combined sewer* or to a *storm sewer*, the hydraulic load from the *fixture* is 29 sq ft for each gallon per minute (0.59 m² for each litre per minute) of flow.

Hydraulic loads from roofs or paved surfaces

4.10.4.(1) Except as provided in Sentence (2), the hydraulic load in square feet from a roof or paved surface is the maximum 15-minute rainfall specified in the Table of Climatic Data in Part 2 of the National Building Code of Canada 1975, multiplied by the sum of

- (a) the area in square feet of the horizontal projection of the surface that is drained, and
- (b) one-half the area in square feet of the largest adjacent vertical surface, except when otherwise *approved*. (See Appendix.)

(2) Where a *flow control roof drain* is installed, the hydraulic load in Sentence (1) may be reduced subject to the approval of the *authority having jurisdiction*.

Conversion of fixture units to square feet

4.10.5.(1) Except as provided in Sentence 4.10.3.(2), where the hydraulic load is to be expressed in square feet, *fixture units* shall be converted as follows:

- (a) when the number of *fixture units* is 256 or fewer, the load is 1000 sq ft, and
- (b) when the number of *fixture units* exceeds 256, the load is 3.9 sq ft for each *fixture unit*.

4.10.6. The hydraulic load that is drained to every *soil-or-waste stack* shall conform to Table 4.10.B.

Table 4.10.B.
Forming Part of Article 4.10.6.

Size of Stack, in.	Maximum Load on <i>Soil-or-Waste Stack, fixture units</i>		
	Maximum load on stack that passes through 3 storeys or less	Maximum load on stack that passes through more than 3 storeys	Maximum load to be drained to stack of more than 3 storeys from any 1 storey
1¼	2	2	1
1½	5	8	2
2	10	24	6
2½	20	42	9
3	60	60	16
4	240	500	90
5	540	1100	200
6	960	1900	350
8	2200	3600	600
10	3800	5600	1000
12	6000	8400	1500
Column 1	2	3	4

4.10.7. The hydraulic load that is drained to a *branch* shall conform to Table 4.10.C.

Hydraulic loads on branches

Table 4.10.C.
Forming Part of Article 4.10.7.

Size of Branch, in.	Maximum Load on <i>Branch, fixture units</i>
1¼	1
1½	3
2	6
2½	12
3	27
4	180
5	390
6	700
8	1600
10	2500
12	3900
Column 1	2

4.10.8. The hydraulic load that is drained to a *sanitary building drain* or a *sanitary building sewer* shall conform to Table 4.10.D.

Hydraulic loads on sanitary building drains or sewers

Table 4.10.D.
Forming Part of Article 4.10.8.

Size of Drain or Sewer, in.	Maximum Load on Drain or Sewer, <i>fixture units</i>					
	Slope, in./ft					
	1/32	1/16	3/32	1/8	1/4	1/2
3	—	—	—	—	27	36
4	—	—	—	180	240	300
5	—	—	380	390	480	670
6	—	—	600	700	840	1300
8	—	1400	1500	1600	2250	3370
10	—	2500	2700	3000	4500	6500
12	2240	3900	4500	5400	8300	13000
15	4800	7000	9300	10400	16300	22500
Column 1	2	3	4	5	6	7

Hydraulic loads on horizontal storm pipes, combined building drains or sewers

4.10.9. The hydraulic load that is drained to a *nominally horizontal pipe in a storm drainage system, a combined building drain or a combined building sewer* shall conform to Table 4.10.E.

Table 4.10.E.
Forming Part of Article 4.10.9.

Size of Pipe, Drain or Sewer, in.	Maximum Load on Pipe, Drain or Sewer, sq ft					
	1/32	1/16	3/32	1/8	1/4	1/2
3	—	—	—	—	1160	1644
4	—	—	—	1880	2650	3760
5	—	—	2880	3340	4720	6680
6	—	—	4650	5350	7550	10700
8	—	8090	10000	11500	16300	23000
10	—	14680	18100	20700	29200	41400
12	17000	23800	29400	33300	47000	66600
15	30700	43200	53200	59400	84000	119000
Column 1	2	3	4	5	6	7

4.10.10. The hydraulic load that is drained to a roof gutter shall conform to Table 4.10.F.

Table 4.10.F.
Forming Part of Article 4.10.10.

Size of Gutter, in.	Area of Gutter, sq. in.	Maximum Load on Gutter, sq ft			
		Slope of Gutter, in./ft			
		1/16	1/8	1/4	1/2
3	3.53	170	240	340	480
4	6.28	360	510	720	1020
5	9.82	625	880	1250	1770
6	14.14	960	1360	1920	2770
7	19.24	1380	1950	2760	3900
8	25.13	1990	2800	3980	5600
10	39.27	3600	5100	7200	10000
Column 1	2	3	4	5	6

4.10.11. The hydraulic load that is drained to a *leader* shall conform to Table 4.10.G.

Hydraulic loads on leaders

Table 4.10.G.
Forming Part of Article 4.10.11.

Circular <i>Leader</i>		Non-Circular <i>Leader</i>	
Size of <i>Leader</i> , in.	Max. Load, sq ft	Area of <i>Leader</i> , sq in.	Max. Load, sq ft
2	720	3.14	650
2½	1300	4.90	1170
3	2200	7.07	1980
4	4600	12.57	4140
5	8650	19.63	7785
6	13500	28.27	12150
8	29000	50.26	26100
Column 1	2	3	4

SECTION 5 VENTING SYSTEMS

SUBSECTION 5.1 VENT PIPES FOR TRAPS

5.1.1.(1) Except as provided in Sentences (2) and (3), a *trap* shall be protected by a *vent pipe*.

Venting for traps

- (2) A *trap* that serves a floor drain need not be protected where
 - (a) the *size* of the *trap* is at least 3 in.,
 - (b) the length of the *fixture drain* is at least 18 in. (457 mm), and
 - (c) the fall on the *fixture drain* does not exceed its *size*. (See Appendix.)

Exception for floor drains

- (3) A *trap* need not be protected by a *vent pipe* where it serves
 - (a) a *subsoil drainage pipe*,
 - (b) a *storm drainage system*, or

Exceptions

- (c) where it forms part of an indirect *drainage system*. (See Appendix.)

SUBSECTION 5.2 SINGLE STOREY WET VENTING

Single Storey
wet venting

5.2.1.(1) A *soil-or-waste pipe* that is extended as a *stack vent* or a *continuous vent* may serve as a *single storey wet vent* provided that

- (a) all *fixtures* served by the *wet vent* are in the same *storey*,
- (b) the number of wet vented *fixtures* does not exceed 4,
- (c) the number of wet vented water closets does not exceed 2,
- (d) when 2 water closets are installed they are connected at the same level by means of an *approved* double fitting,
- (e) the water closets are connected downstream of all other *fixtures*, and
- (f) the *fixture drains* are connected separately and directly into the *soil-or-waste pipe*. (See Appendix.)

5.2.2.(1) A section of a *branch* or *building drain* may serve as a *single storey wet vent* provided that

- (a) a *circuit vent* is connected to it,
 - (b) all *fixtures* served by the *circuit vent* are located in the same *storey*, and
 - (c) no *soil-or-waste stack* is connected to it upstream of a wet vented *fixture*.
- (2) A *relief vent* shall be connected to the *branch* or *building drain* that forms part of a circuit vented system
- (a) downstream of the connection for the circuit vented *fixture* that is farthest downstream when the *soil-or-waste pipe* to which the wet vented system is connected receives a hydraulic load of more than 6 *fixture units* upstream of that connection,
 - (b) so that the cumulative horizontal change in direction in the *branch* or *building drain* between *vent pipes* does not exceed 45 deg., and
 - (c) so that there are not more than 8 wet vented *fixtures* connected to the *branch* or *building drain* between *vent pipe* connections.
- (3) A *soil-or-waste pipe* that is extended as a *continuous vent* may serve as a *relief vent* provided the *soil-or-waste pipe* is sized as a *wet vent* in conformance with Articles 5.6.2. and 5.7.1.

(4) A *relief vent* may serve 2 or more groups of circuit vented *fixtures*. (See Appendix.)

SUBSECTION 5.3 VENT PIPES FOR SOIL-OR-WASTE STACKS

Stack vents

5.3.1.(1) The upper end of every *soil-or-waste stack* shall terminate in a *stack vent*.

Stack venting

(2) A *stack vent* may serve as the *vent pipe* for 1 or 2 *fixtures* connecting at the same level. (See Appendix.)

Vent stacks

5.3.2.(1) A *vent stack* shall be installed to protect the base of every *soil-or-waste stack* that has *fixtures* draining to it on more than 4 *storeys*.

(2) The *vent stack* shall be connected to the *soil-or-waste stack* at or below the lowest *soil-or-waste pipe* connection, or at the junction of the *soil-or-waste stack* with a *branch* or *building drain*. (See Appendix.)

Yoke vents

5.3.3.(1) Except as provided in Sentence (4), where a *soil-or-waste stack* receives the discharge from *fixtures* located on more than 11 *storeys* a *yoke vent* shall be installed

- (a) for each section of 5 *storeys* or part thereof on which *fixtures* are located other than the top and bottom 5 *storeys*, and
- (b) at or immediately above each *offset* or double *offset*.

(2) The *yoke vent* shall be connected to the *soil-or-waste stack* by means of a drainage fitting at or immediately below the lowest *soil-or-waste pipe* from the lowest *storey* of the section described in Sentence (1).

(3) The *yoke vent* shall be connected to the *vent stack* at least 3 ft 3 in (1.0 m) above the floor level of the lowest *storey* in the section described in Sentence (1).

(4) A required *yoke vent* need not be installed provided the *soil-or-waste stack* is interconnected to the *vent stack* in each *storey* of the section in which *fixtures* are located by means of a *fixture* or a group of vented *fixtures* installed in accordance with Subsection 5.2.

SUBSECTION 5.4 MISCELLANEOUS VENT PIPES

5.4.1. Every sump that receives *sewage* shall be provided with a *vent pipe* that is connected to the top of the sump. Venting of sewage sumps

5.4.2.(1) Every oil *interceptor* shall be provided with 2 *vent pipes* that Venting of oil interceptors

- (a) connect to the *interceptor* at opposite ends,
- (b) extend independently to open air, and
- (c) terminate at elevations differing by at least 1 ft (0.3 m).

(2) Adjacent compartments within every oil *interceptor* shall be connected to each other by a vent opening.

5.4.3. Where a *building trap* is installed, a *fresh air inlet* not less than 4 in. in *size* shall be connected upstream and within 4 ft (1.2 m) of the *building trap* and downstream of any other connection. (See Appendix explaining Sentence 4.5.4.(1).) Fresh air inlets

SUBSECTION 5.5 ARRANGEMENT OF VENT PIPES

5.5.1. Every *vent pipe* shall be installed without depressions in which moisture can collect. Drainage of vent pipes

5.5.2.(1) Every *vent pipe* shall be connected as directly as possible from its lower end to outside air, and where it is possible to do so the pipe shall be installed in a *nominally vertical* position. Vent pipe connections

(2) Except for *wet vents*, where a *vent pipe* is connected to a *nominally horizontal soil-or-waste pipe* the connection shall be above the horizontal centre line of the *soil-or-waste pipe*. (See Appendix.)

5.5.3.(1) Except as provided in Sentences (2) and (3), a *vent pipe* that protects a *fixture trap* shall be located so that Location of vent pipes

- (a) the *developed length* of the *trap arm* is
 - (i) not less than twice the *size* of the *fixture drain*, and
 - (ii) not more than 5 ft (1.5 m),
- (b) the total fall of the *trap arm* is not greater than the *size* of the *fixture drain*, and
- (c) the *trap arm* does not have a cumulative change of direction of more than 135 deg. (See Appendix.)

(2) The *trap arm* of water closets, *S-trap standards* or *fixtures* that depend on siphonic action for the proper functioning of the *fixture* that discharges vertically shall not have a cumulative change of direction of more than 225 deg. (See Appendix.)

(3) A *vent pipe* that protects a water closet or a *fixture* that depends on siphonic action for its proper functioning shall be so located that the distance between connections of the *fixture drain* to the *fixture* and the *vent pipe* shall not exceed

- (a) 3 ft (0.9 m) in the vertical plane, and

(b) 10 ft (3 m) in the horizontal plane.

Vents to connect above fixtures they serve

5.5.4.(1) An *individual vent, dual vent, continuous vent, circuit vent* or *relief vent* shall extend above the *floor level rim* of every *fixture* that it serves before being connected to another *vent pipe*.

(2) No *vent pipe* shall be connected to a *branch vent* or a *vent stack* in such a manner that a blockage in a *soil-or-waste pipe* would cause waste to drain through the *vent pipe* to the *drainage system*.

Terminals

5.5.5.(1) The upper end of every *vent pipe* that is not terminated in open air shall be connected to a *venting system* that is terminated in open air.

(2) The upper end of every *vent pipe* that is terminated in open air, other than a *vent pipe* that serves an *oil interceptor* or a *fresh air inlet*, shall be extended through a roof.

- (3) Where a *vent pipe* is terminated in open air the terminal shall be located
 - (a) at least 3 ft (0.9 m) above or 12 ft (3.7 m) in any other direction from every air inlet, openable window or door,
 - (b) except for a *fresh air inlet*, at least 7 ft (2.1 m) above or 12 ft (3.7 m) in any other direction from a roof that supports an *occupancy*,
 - (c) at least 7 ft (2.1 m) above ground, and
 - (d) at least 6 ft (1.8 m) from every property line. (See Appendix.)

- (4) Where a *vent pipe* passes through a roof it shall
 - (a) terminate high enough to prevent the entry of roof drainage but at least 1 in. (25 mm) above the roof, and
 - (b) be flashed to prevent the entry of water between the *vent pipe* and the roof.

(5) Where a *vent pipe* passes through a roof and may be subject to frost closure it shall be protected from frost closure

- (a) by keeping its height to a minimum,
- (b) by being increased at least 1 size immediately before penetrating the roof,
- (c) by being insulated, or
- (d) by being protected in some other manner acceptable to the *authority having jurisdiction*.

SUBSECTION 5.6 MINIMUM SIZE OF VENT PIPES

General

5.6.1. The size of every *vent pipe* shall conform to Table 5.6.A.

Table 5.6.A.

Forming Part of Article 5.6.1.

Size of Trap Served, in.	Minimum Size of Vent Pipe, in.
1¼	1¼
1½	1¼
2	1½
2½	1½
3	1½
4	1½
5	2
6	2
Column 1	2

5.6.2. A *branch vent, stack vent, vent stack* or *header* shall be of a size not less than the size of a *vent pipe* that is connected to it.

5.6.3. Except as provided in Article 5.6.1., the minimum size of a *relief vent* installed in conjunction with a *circuit vent* shall be 1 size smaller than the required size of the *circuit vent*. Relief vents

5.6.4. Except as provided in Article 5.6.1., the minimum size of a *yoke vent* shall be 1 size smaller than the size of the smaller pipe to which it is connected. Yoke vents

5.6.5.(1) Except as provided in Sentence (2), the minimum size of the *vent pipe* for a *sewage sump* shall be 1 size smaller than the size of the largest inlet pipe to the sump. Sewage sump vents

(2) The minimum size of every *vent pipe* for a *sewage sump* shall be 2 in., but the *vent pipe* need not be larger than 4 in.

5.6.6. The minimum size of every *vent pipe* that serves an oil *interceptor* shall be 2 in. Oil interceptors

SUBSECTION 5.7 SIZING OF VENT PIPES

(See Appendix for an explanation of sizing of vent pipes.)

5.7.1. A single *storey wet vent* shall be sized in conformance with Table 5.7.A. (See Appendix.)

Table 5.7.A.
Forming part of Article 5.7.1.

Size of <i>Wet Vent</i> , in.	Maximum Hydraulic Load Connected to a Single <i>Storey Wet Vent</i> , fixture units
1¼	1
1½	2
2	5
2½	8
3	18
4	120
Column 1	2

5.7.2.(1) A *circuit vent, a branch vent, a header* and a *continuous vent* other than one that is an *individual vent* or a *dual vent*, shall be sized in conformance with Table 5.7.B.

(2) The length of a *continuous vent* for the purpose of Table 5.7.B. shall be its *developed length* from the vertical *soil-or-waste pipe* to a *vent stack, stack vent, header* or open air.

(3) The length of a *circuit vent* for the purpose of Table 5.7.B. shall be its *developed length* from the horizontal *soil-or-waste pipe* to a *vent stack, stack vent, header* or open air.

(4) The length of a *branch vent* for the purpose of Table 5.7.B. shall be the *developed length* of vent piping from the most distant *soil-or-waste pipe* connection to a *vent stack, stack vent, header* or open air.

(5) The length of a *header* for the purpose of Table 5.7.B. shall be the *developed length* of vent piping from the most distant *soil-or-waste pipe* connection to open air. (See Appendix.)

Table 5.7.B.
Forming part of Sentence 5.7.2.(1)

Maximum Load Served, <i>fixture units</i>	Size of Vent Pipe, in.								
	1¼	1½	2	2½	3	4	5	6	8
	Maximum Length of Vent Pipe, ft.								
2	30								
8	30	100				NOT LIMITED			
20	25	50	150						
40	15	30	100	300					
60		15	50	80	400				
100			30	70	180	700			
1100				20	50	200	700		
1900		NOT PERMITTED			20	70	200	700	
3600						25	60	250	800
5600							25	60	250
Column 1	2	3	4	5	6	7	8	9	10

5.7.3.(1) A *stack vent* or *vent stack* shall be sized in accordance with Table 5.7.C.

Stack vents and vent stacks

(2) The length of a *stack vent* or a *vent stack* for the purpose of Table 5.7.C shall be its *developed length* from its lower end to open air. (See Appendix.)

Table 5.7.C.

Forming part of Sentence 5.7.3.(1)

Size of Soil-or-waste Stack, in.	Total Hydraulic Load Served by Vent, fixture units	Size of Stack Vent or Vent Stack, in.									
		1¼	1½	2	2½	3	4	5	6	8	
		Maximum Length of Vent Pipe, ft.									
1¼	0-2	30									
1½	0-8	50	150								
2	0-8	30	75	200							
2	9-20	26	50	150							
2½	0-20		45	150	400						
2½	21-42		30	100	300						
3	0-10		30	100	200	600					
3	11-30		15	60	200	500					
3	31-60		15	50	80	400					
4	0-100			35	100	260	1000				
4	101-200			30	90	250	900				
4	201-500			20	70	180	700				
5	0-200				35	80	350	1000			
5	201-500				30	70	300	900			
5	501-1100				20	50	200	700			
6	0-350				25	50	200	400	1300		
6	351-620				15	30	125	300	1100		
6	621-960					24	100	250	1000		
6	961-1900					20	70	200	700		
8	0-600						50	150	500	1300	
8	601-1400						40	100	400	1200	
8	1401-2200						30	90	350	1100	
8	2201-3600						25	60	250	800	
10	0-1000							75	125	1000	
10	1001-2500							50	100	500	
10	2501-3300							30	80	350	
10	3301-5600							25	60	250	
Column 1	2	3	4	5	6	7	8	9	10	11	

NOT PERMITTED

NOT LIMITED

6.1.13.(1) In addition to the requirements in Sentence (2), every hot water tank of a *storage-type service water heater* shall be equipped with a pressure relief valve designed to open when the water pressure in the tank reaches the rated working pressure of the tank, and so located that the pressure in the tank shall not exceed the pressure at the relief valve by more than 5 psi (34.5 kN/m²) under any condition of flow within the distribution system.

Pressure relief valves for storage type service water heaters

(2) Every hot water tank of a *storage-type service water heater* shall be equipped with

Temperature relief valves

(a) a temperature relief valve with a temperature sensing element located within the top 6 in. (152 mm) of the tank and designed to open and discharge sufficient water from the tank to keep the temperature of the water in the tank from exceeding 210°F (99°C) under all operating conditions, or

(b) a device that

Temperature limit control

(i) is designed to shut off the supply of electricity or fuel to the heater, (ii) is not connected to and operates independently of the thermostatic control that determines the temperature of the water in the tank, and

(iii) is located and maintained on or within the top 6 in. (152 mm) of the tank so that the maximum temperature of the water in the tank shall not exceed 210°F (99°C) under all operating conditions.

(3) Every tank equipped as specified in Clause 6.1.13.(2)(b) shall bear the information in a clearly visible location that it is so equipped.

(4) A pressure relief valve and a temperature relief valve may be combined where Sentences (1) and (2) are complied with.

Combination pressure and temperature relief valves

(5) Every pipe that conveys water from a temperature relief, pressure relief or a combined temperature and pressure relief valve which is installed on a hot water tank shall

Relief valve pipe discharge

(a) have a *size* at least equal to the *size* of the outlet of the valve, and

(b) terminate above a floor drain, sump or *fixture* or other *approved* safe location.

(6) No shut-off valve shall be installed on the pipe between the tank and the relief valves or on the discharge lines from such relief valves.

(7) A *backflow preventer* shall be installed when requested by the *authority having jurisdiction*.

Backflow preventer

(See Articles 6.2.3. to 6.2.6. which give methods of meeting this requirement.)

6.1.14. Every valve shall be readily accessible for service or replacement.

Accessibility

6.1.15. Air chambers or shock stops shall be installed in conjunction with spring-action or quick-closing valves and taps to prevent water hammer. Shock stops that are of a mechanical nature shall be located in an accessible place.

Water hammer

SUBSECTION 6.2 PROTECTION FROM CONTAMINATION

6.2.1.(1) No part of a *potable water system* shall be connected so that foreign matter or non-*potable* water may enter, except that a water treatment device or apparatus may be installed with the written permission of the health *authority having jurisdiction*.

Connection of systems

(2) No *private water supply system* shall be interconnected with a public water supply system.

(3) No *potable* water pipe shall be connected to an ejector unless provided with an *approved vacuum breaker*.

(4) Aspirators shall not be *directly connected* to a *waste pipe* that is connected to a sewer, but may be connected to the inlet side of a *trap*, and shall be equipped with an *approved vacuum breaker* installed at least 6 in. (152 mm) above the aspirator unit. The aspirator unit shall be designed to provide for free flow discharge through an *air gap*. The length of the discharge pipe or tube from the aspirator shall at no time exceed 12 in. (305 mm).

(5) No water operated equipment shall be installed and no foreign chemical or substance that may cause pollution shall be used in a *potable* water supply, except that such equipment may be permitted by the *authority having jurisdiction* when equipped with an *approved backflow preventer*. The use of an *approved* assembly of differential valves and *check valves* including an automatically opened spillage port to the atmosphere designed to prevent *backflow* is permitted in installations where it is desirable to zone or isolate a multiple of openings or connections. (See Appendix.)

Cleaning of systems

6.2.2. A newly installed part of a *water system* shall be thoroughly cleaned to ensure freedom from contamination before the system is put into operation.

Air gap or back-siphonage preventer

6.2.3.(1) Except for a *fixture* in which the water surface may be exposed to a pressure greater than atmospheric, a water supply inlet including a float-operated inlet shall be

- (a) located so as to provide an *air gap*, or
- (b) provided with a *back-siphonage preventer*.

(2) Except as provided in Sentence (3), an *air gap* shall be provided above, or a *back-siphonage preventer* installed so that its *critical level* is above the *flood level rim* of the *fixture*.

(3) In a tank or vat an *air gap* may be provided above, or a *back-siphonage preventer* installed so that its *critical level* is above, the maximum water level in the tank or vat where the tank or vat is provided with an overflow that can, when all other inlets are open and the outlet is closed, maintain the water level at a distance above the top of the overflow that does not exceed

- (a) one-half the required *air gap* where an *air gap* is provided, or
- (b) the *size* of the inlet where a *back-siphonage preventer* is installed. (See Appendix.)

Height of air gap

6.2.4.(1) The height of every *air gap* shall be

- (a) at least twice the diameter of the *effective opening* of the water supply inlet, except that where the inlet is located so that its inside edge is within 3 times the diameter of the *effective opening* from a vertical surface, or within 4 times the diameter of the *effective opening* from each of 2 adjacent vertical surfaces, the height of the *air gap* shall be at least 3 times the diameter of the *effective opening*,
- (b) at least 1 in. (25 mm) where the *fixture* is other than a drinking fountain, or
- (c) at least $\frac{3}{4}$ in. (19 mm) where the *fixture* is a drinking fountain. (See Appendix.)

Height of back-siphonage preventers

6.2.5.(1) The height at which the *critical level* of a *back-siphonage preventer* is installed above a *flood level rim* or maximum water level shall be

- (a) at least 4 times the diameter of the inlet of the fixture control valve or faucet, and
- (b) at least 4 in. (102 mm) where the *back-siphonage preventer* is installed in other than a water-closet tank, or
- (c) at least 1 in. (25 mm) where the *back-siphonage preventer* is installed in a water-closet tank. (See Appendix.)

(2) Where the *critical level* is not marked on a *back-siphonage preventer*, the outlet of the *back-siphonage preventer* shall be assumed to be its *critical level*.

- 6.2.6.** Where a *back-siphonage preventer* is installed, it shall be located on the downstream side of the *fixture* control valve or faucet so that it will be subject to pressure only when the valve or faucet is open. (See Appendix explaining Sentence 6.2.5.(1).) Location of back-siphonage preventers
- 6.2.7.** Where a water supply pipe is connected to a device which may be subjected to a pressure in excess of atmospheric, the pipe shall be protected with an assembly of differential valves and *check valves* including an automatically opened spillage port to the atmosphere designed to prevent *backflow*. (See Appendix explaining backflow preventer.) Protection of devices under pressure
- SUBSECTION 6.3 TANKS**
- 6.3.1.** Every tank shall be supported independently of the piping that is connected to it. Support of tanks
- 6.3.2.** Every tank that is not under pressure shall Protection of non-pressurized tanks
- (a) not be located under drainage or non-*potable* water piping,
 - (b) be provided with a cover that prevents the entrance of foreign matter, and
 - (c) be provided with an overflow pipe that will prevent flooding when all inlets to the tank are open and all outlets except the overflow are closed.
- 6.3.3.** A cover of a tank that is under pressure shall not be located under drainage or non-*potable* water piping. Protection of pressurized tanks

SUBSECTION 6.4 WELLS

- 6.4.1.** Every well shall be constructed so that the well water is protected against surface water contamination or other pollutants.

SUBSECTION 6.5 SIZE AND CAPACITY OF PIPES

(See Appendix A.)

- 6.5.1.(1)** Except as provided in Sentence (2), the *size* of a pipe that supplies a *fixture* or device shall conform to Table 6.5.A. Fixture supply pipes
- (2) A tail piece or connector not more than 30 in. (762 mm) in length and not less than ¼ in. (6 mm) inside diameter may be used.

Table 6.5.A.
Forming Part of Sentence 6.5.1.(1)

<i>Fixture or Device</i>	<i>Minimum Size of Supply Pipe, in.</i>
Bath tub	½
Combination sink and tray	½
Drinking fountain	⅝
Dishwasher, domestic	½
Kitchen sink, domestic	½
Kitchen sink, commercial	¾
Lavatory	⅝
Laundry tray: 1, 2 or 3 compartments	½
Shower, single head	½
Sink, service, slop	½
Sink, flushing rim	¾
Urinal, flush tank	½
Urinal, direct flush valve	¾
Water closet, flush valve type	1
Water closet, tank type	⅝
Hose bib	½
Wall hydrant	½
Column 1	2

Capacity of system and piping

6.5.2.(1) Every *potable water system* shall be designed, constructed and installed to conform to good engineering practice.

(2) Every *water service pipe* shall have a capacity not less than the peak demand flow and a size at least ¾ in.

(3) The capacity of every pipe that supplies a *fixture* shall be not less than the flow that will flush the *fixture* and keep it in a sanitary condition.

(4) Where static pressures may exceed 80 psi (551 kN/m²), pressure reducing devices shall be installed to limit the maximum static pressure in habitable areas to 80 psi (551 kN/m²).

SECTION 7 NON-POTABLE WATER SYSTEMS

SUBSECTION 7.1 CONNECTION

7.1.1. A *non-potable water system* shall not be connected to a *potable water system*.

SUBSECTION 7.2 IDENTIFICATION

7.2.1. *Non-potable water piping* shall be identified by markings that are permanent, distinct and easily recognized.

SUBSECTION 7.3 LOCATION

7.3.1. *Non-potable water piping* shall not be located
 (a) where food is prepared in a food processing plant,
 (b) above food-handling equipment,

Location of pipe

- (c) above a non-pressurized *potable* water tank, or
- (d) above a cover of a pressurized *potable* water tank.

7.3.2. An outlet from a non-*potable water system* shall not be located where it can discharge into

Location of
outlets

- (a) a sink or lavatory,
- (b) a *fixture* into which an outlet from a *potable water system* is discharged, or
- (c) a *fixture* that is used for a purpose related to the preparation, handling or dispensing of food, drink or products that are intended for human consumption.

APPENDIX

EXPLANATORY MATERIAL for the Canadian Plumbing Code 1975

(This Appendix contains notes, explanations and diagrams that apply to the requirements of this Code. The bold-face reference numbers that introduce each item apply to the requirements in the main body of the Code to which the explanatory material is applicable. The bold-face captions following these reference numbers describe the subjects to which the references apply.)

SYMBOLS AND ABBREVIATIONS

The following symbols and abbreviations have been used in the diagrams:

Water and drainage pipe _____ Subsoil drains — — — —

Vent pipe - - - - -

BG	Bathroom group	KS	Kitchen sink
BT	Bathtub	LAV	Lavatory
CO	Cleanout	LT	Laundry tray
DF	Drinking fountain	RD	Roof drain
FD	Floor drain	UR	Urinal
FS	Floor sink	WC	Water closet

Definition for *Backflow preventer*

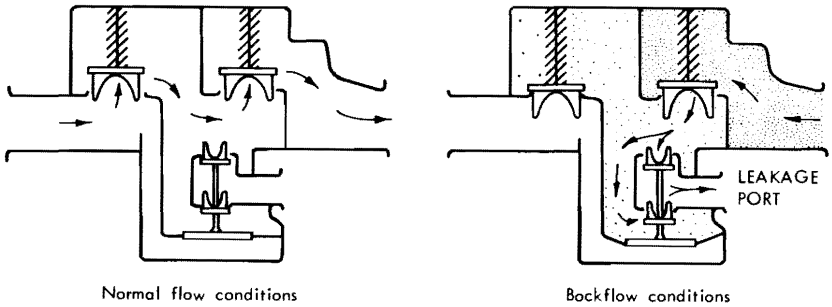

(a) Reduced pressure backflow preventer

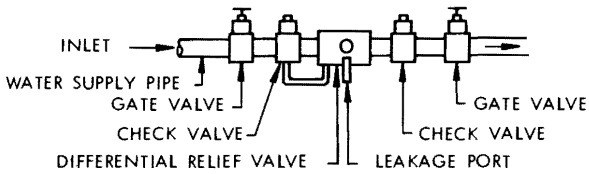

(b) Assembly of differential valves and check valves used as a backflow preventer

Definition for *Back-siphonage*

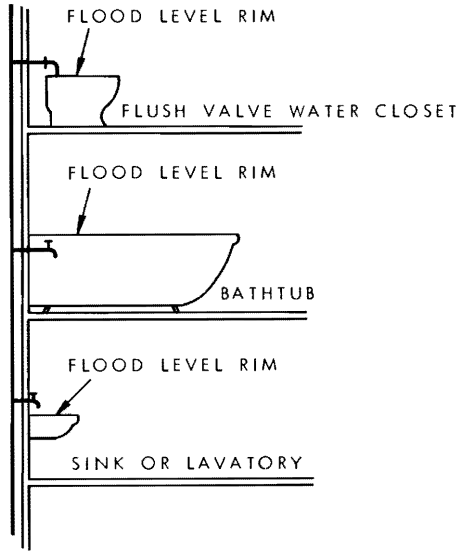

This diagram shows a situation that is fairly common in old buildings. If the bathtub is filled to a level above the faucet outlet, or if the flush valve of the water closet is faulty, and if the faucet at the sink or lavatory on the lower floor is opened, water can be drawn (siphoned) from the bathtub or the water closet into the water system when the pressure in the water system is low or the water supply has been shut off.

Definition for *Back-siphonage preventer*

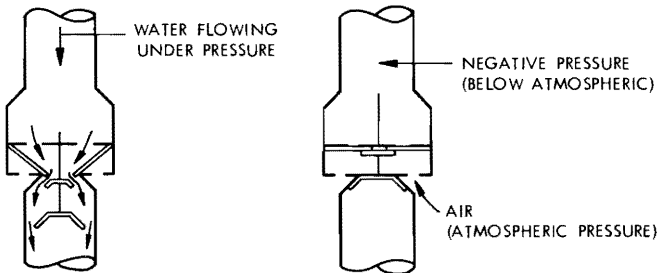

(a) Normal operation with valve open

(b) No backflow - valve closed by atmospheric pressure

Back-siphonage can be prevented in the above situations by providing an air gap or a back-siphonage preventer (see Subsection 6.2 of this Code).

Definition for *Branch vent*

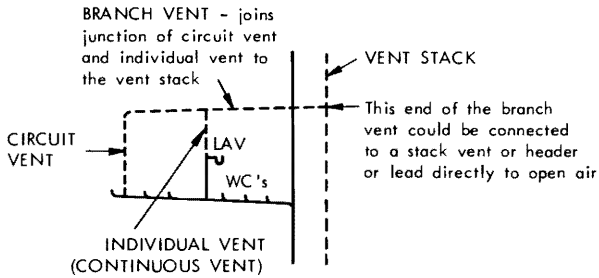

(See also explanation for definitions for header and drainage system.)

Definition for *Circuit vent*

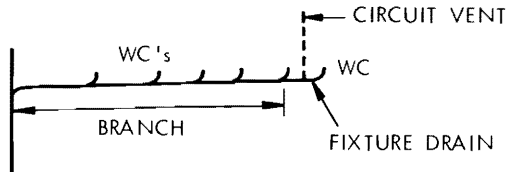

(See also explanation for definition for *drainage system*.)

Definition for *Clear-water waste*

Examples of clear-water waste are the waters discharged from a drinking fountain, cooling jacket, air conditioner or relief valve outlet.

Definition for *Drainage system* DRAINAGE AND VENTING SYSTEMS

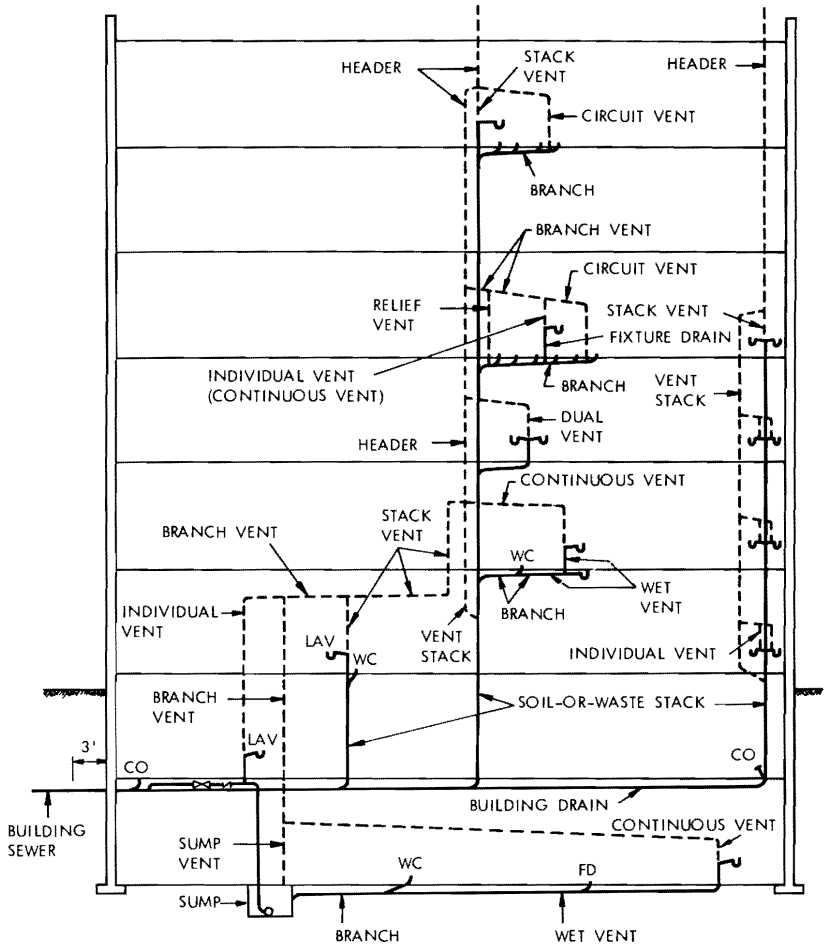

**Definition for *Drainage system* (Cont'd.) PARTIAL DRAINAGE SYSTEM
(ISOMETRIC VIEW)**

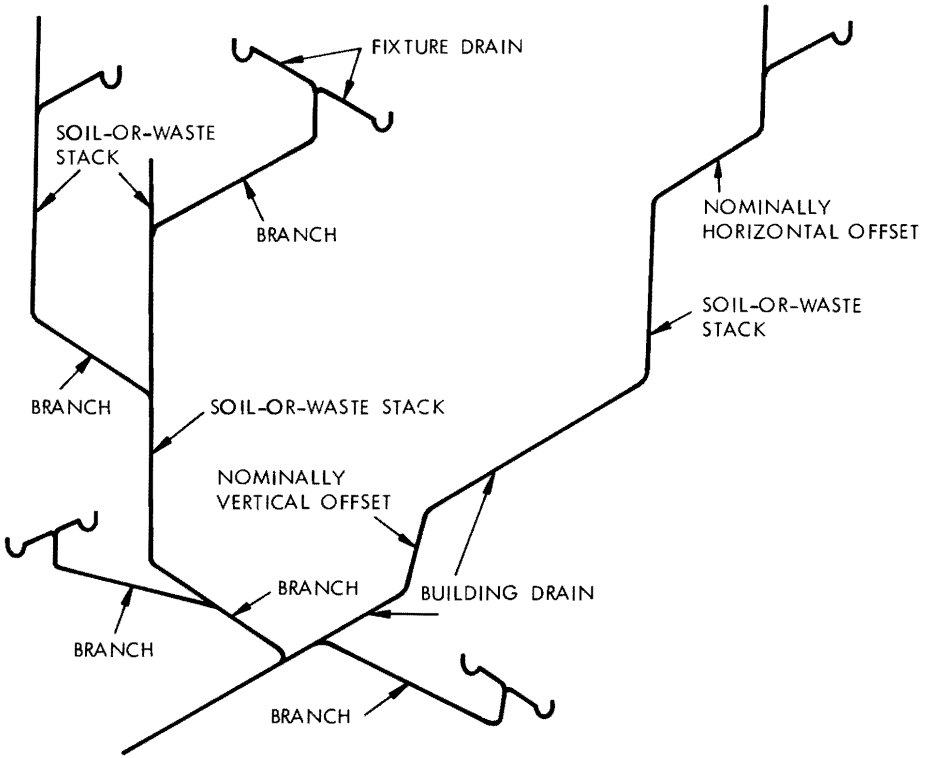

Definition for *Effective opening*

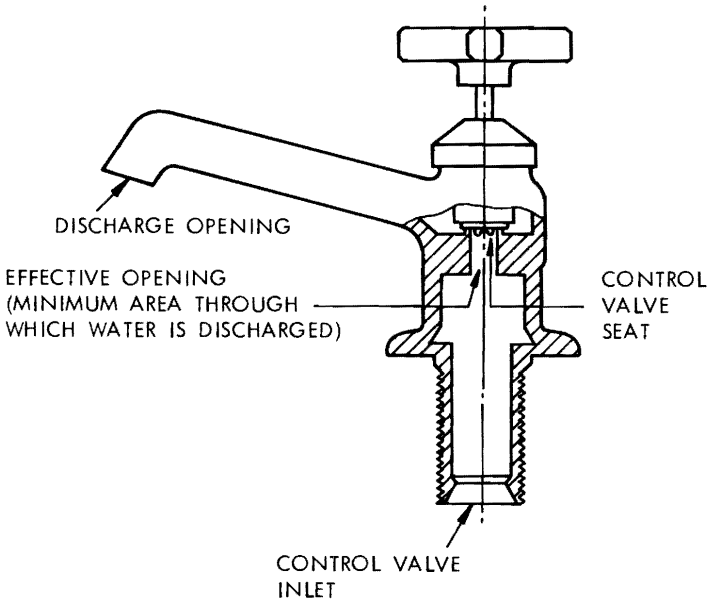

Diameter of effective opening: where the effective opening is not circular, its “diameter” is the diameter of a circle of the same cross-sectional area.

Definitions for *Fixture drain* and *Fixture outlet pipe*

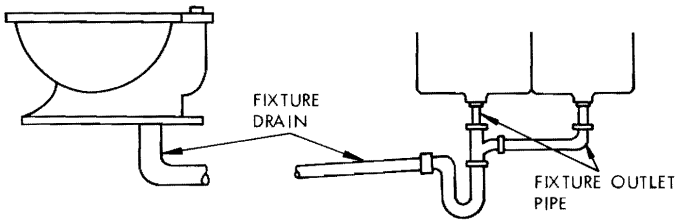

Definition for *Header*

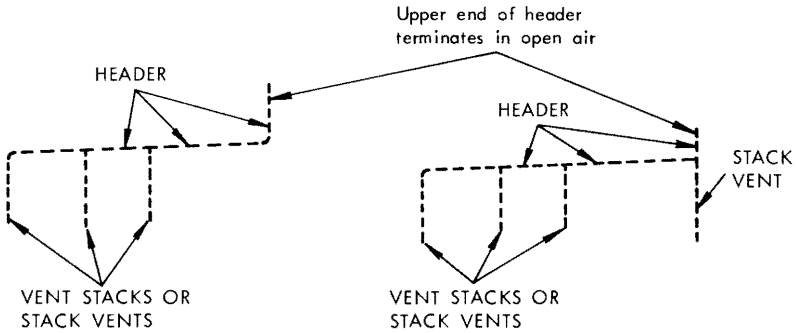

Although a header is similar to a branch vent, it serves the special purpose of connecting the tops of stack vents or vent stacks. To make certain that it is adequate for that purpose it is made larger than a branch vent. The developed length used to determine its size is the total length from the most distant soil-or-waste pipe to open air, rather than the shorter length used to size a branch vent.

Definitions for *Nominally horizontal* and *Nominally vertical*

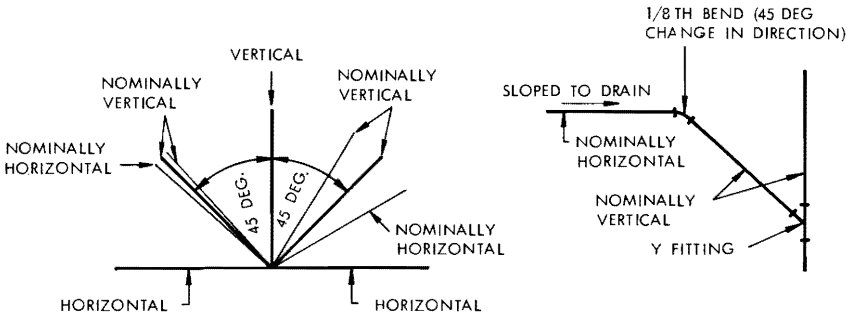

Definition for *Offset*

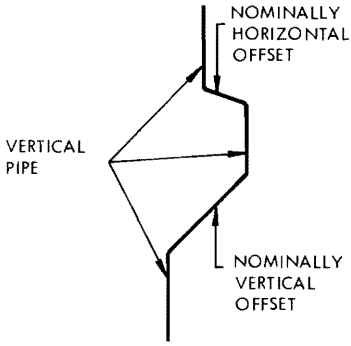

(a) Elevation view of vertical pipe



(b) Plan view of horizontal pipe

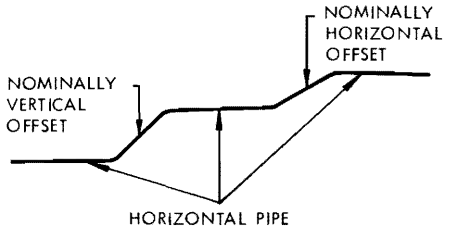

(c) Elevation view of horizontal pipe

Definition for *Plumbing system*

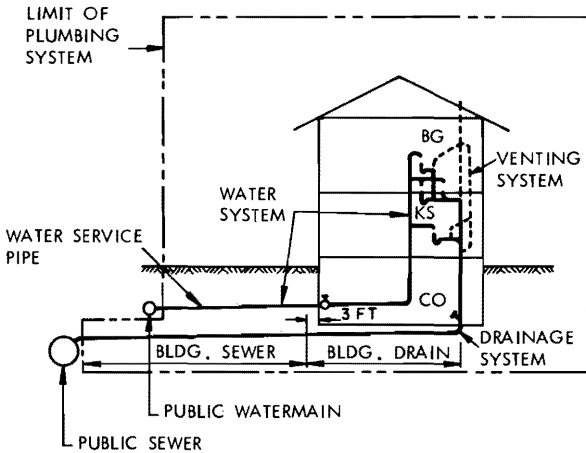

Article 1.6.4. SERVICE PIPING

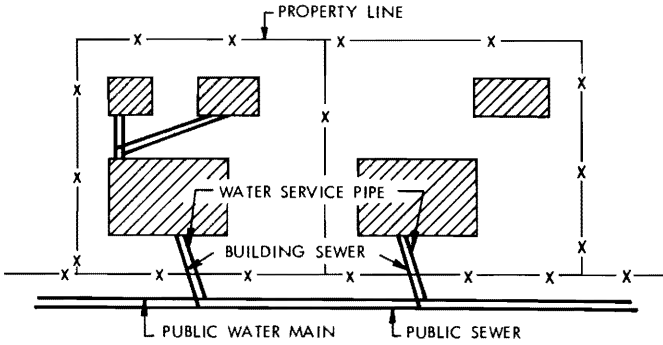

(a) Permitted

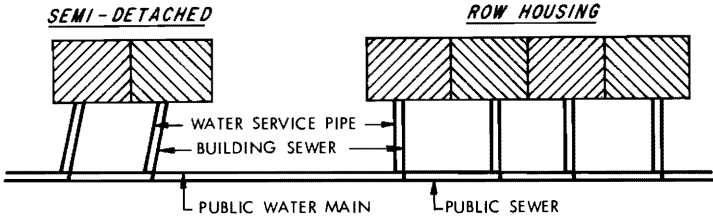

(b) Permitted

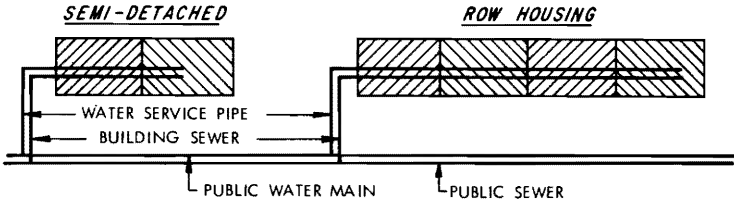

(c) Permitted

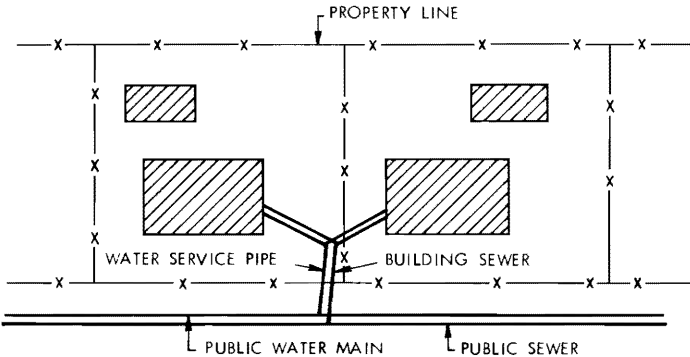

(d) Not permitted

The layout as shown in diagram (c) above may require special legal arrangements in some jurisdictions to ensure that access can be provided to all parts of the service pipes.

Sentence 2.2.4.(3) SHOWER DRAINAGE, PLAN VIEW

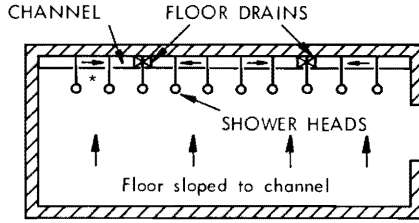

(a) Permitted

* Minimum distance between shower heads - 30 in.

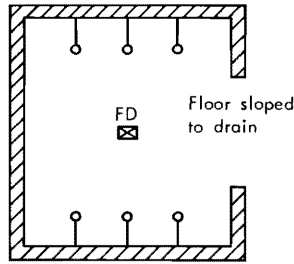

(b) Not permitted

Article 2.2.6.

This does not preclude the use of a standing waste.

Sentences 2.3.1.(1) and 2.3.1.(2) TRAP SEAL AND TRAP CONNECTIONS

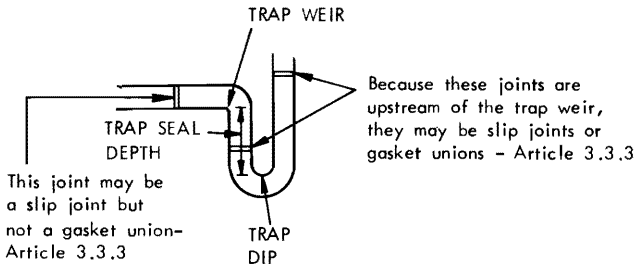

Sentence 2.3.1.(3) PROHIBITED TRAPS

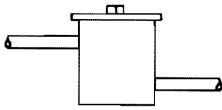

(a) Drum trap

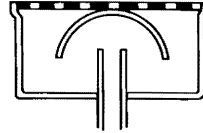

(b) Bell trap



(c) S trap

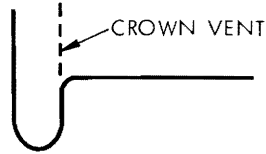

(d) Crown vented trap

Except for an S-trap standard, the S trap shown in diagram (c) above is prohibited by Clause 5.1.1.(2)(c) which limits the fall on fixture drains. Crown vented traps shown in diagram (d) are prohibited by Clause 5.5.3.(1)(a) which requires that the distance from the trap weir to the vent be not less than twice the size of the fixture drain.

Article 2.4.1. T FITTINGS IN DRAINAGE SYSTEMS

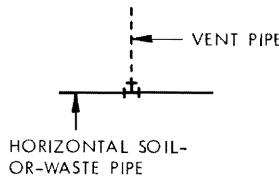

(a) Permitted

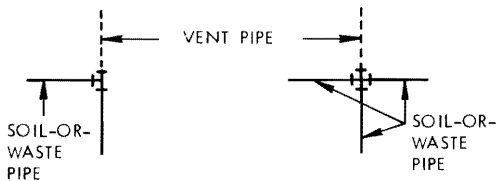

(b) Not Permitted

This prohibits the use of a cross fitting in a drainage system, but such fitting may be used in a venting system to connect 4 vent pipes. In a drainage system a T fitting can only be used as shown in diagram (a), and cannot be used as shown in diagram (b) because the T or cross fitting would change the direction of flow in the drainage system.

Article 2.4.2. SANITARY T FITTINGS IN DRAINAGE SYSTEMS

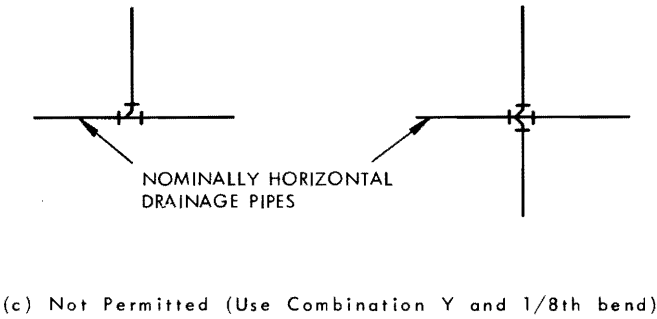
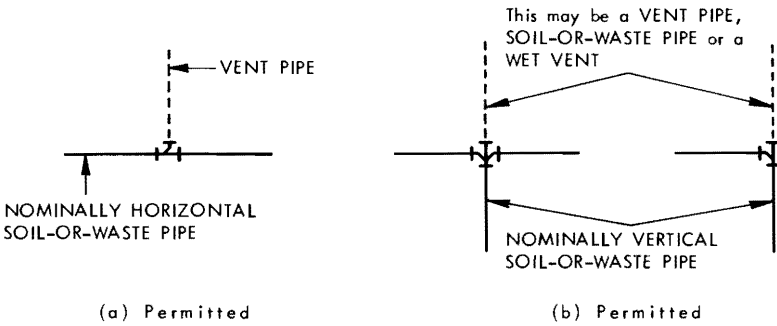

A Sanitary T fitting may be used to change the direction of flow in a drainage system from horizontal to vertical, but may not be used to change the direction of flow in a nominally horizontal drainage system.

Article 2.4.3. DOUBLE Y FITTINGS

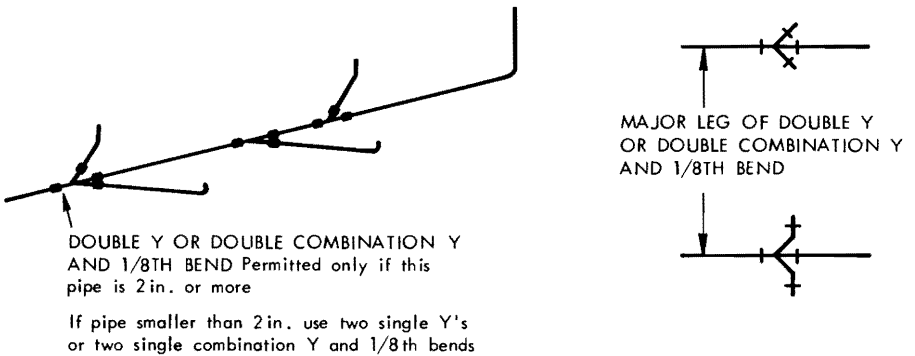

Subsections 2.5, 2.6 and 2.7 SUMMARY OF PIPE APPLICATIONS

Type of Piping	Code Reference	Use of Piping							
		Drainage System			Venting System		Water System		
		Above ground inside building	Underground inside building	Building Sewer	Above ground	Underground	Above ground	Underground inside building	Underground outside building
Asbestos-cement drainage pipe	2.5.1.	(1)	P	P	N	N	N	N	N
Asbestos-cement water pipe	2.5.2.	N	P	P	N	P	N	P	P
Bituminized-fibre pipe	2.5.3.	N	N	(2)	N	N	N	N	P
Concrete sewer pipe	2.5.4.	N	N	P	N	N	N	N	NA
Vitrified clay pipe	2.5.5.	N	P	P	N	N	N	N	N
Polyethylene water pipe	2.5.6.	N	N	N	N	N	N	(3)	(3)
Poly (vinyl chloride) (PVC) water pipe	2.5.7.	P	P	P	P	P	(4)	(4)	(4)
Chlorinated poly (vinyl chloride) (CPVC) water pipe	2.5.8.	P	P	P	P	P	P	P	P
Plastic sewer pipe	2.5.9.	N	N	P	N	N	N	N	N
Acrylonitrile-butadiene-styrene (ABS) DWV Pipe	2.5.10.	(5)	P	P	(5)	P	NA	NA	NA
Poly (vinyl chloride) (PVC) DWV Pipe	2.5.10.	(5)	P	P	(5)	P	N	N	N
Cast-iron soil pipe	2.6.1.	P	P	P	P	P	NA	NA	NA
Cast-iron water pipe	2.6.4.	P	P	P	P	P	P	P	P
Welded and seamless steel, galvanized pipe	2.6.7.	P	N	N	P	N	(2)	(2)	(2)
Corrugated steel, galvanized pipe	2.6.8.	N	N	(6)	NA	N	NA	N	N
Sheet metal pipe	2.6.9.	(7)	N	N	N	N	N	N	N
Copper and brass pipe	2.7.1.	P	P	P	P	P	P	P	P
Copper tube—Types K and L hard	2.7.4.	P	P	P	P	P	P	P	P
Copper tube—Types K and L soft	2.7.4.	N	N	N	N	N	P	P	P
Copper tube—Type M	2.7.4.	P	N	N	P	N	P	N	N
Copper tube—Type DWV	2.7.4.	P	N	N	P	N	N	N	N
Lead waste pipe	2.7.8.	P	P	N	P	P	N	N	N
Column 1	2	3	4	5	6	7	8	9	10

Notes to Table:

N—Not permitted P—Permitted NA—Not applicable

(1) Permitted only (a) in a crawl space next to the ground, or (b) in a storm drainage system.

(2) Permitted when approved.

(3) Permitted only for water service pipe.

(4) Not permitted in hot water systems.

(5) See Sentence 3.1.4.5 (5) and Articles 3.1.7.7., 3.1.9.1., 9.10.9.9., 9.10.9.10., 9.10.9.27. and 9.10.16.7. of the National Building Code of Canada 1975.

(6) Permitted only underground in a storm drainage system.

(7) Permitted only for an external leader.

Sentence 3.3.11.(2) AIR BREAK

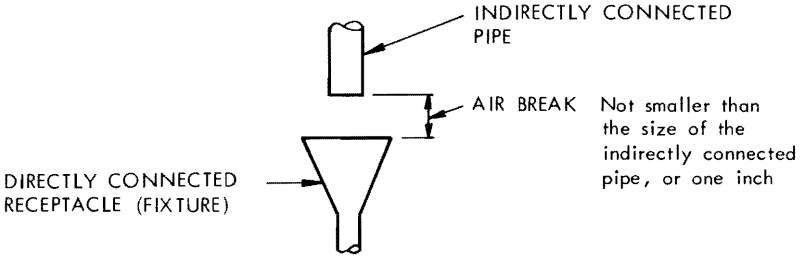

Article 3.4.6. SUPPORT FOR UNDERGROUND PIPING

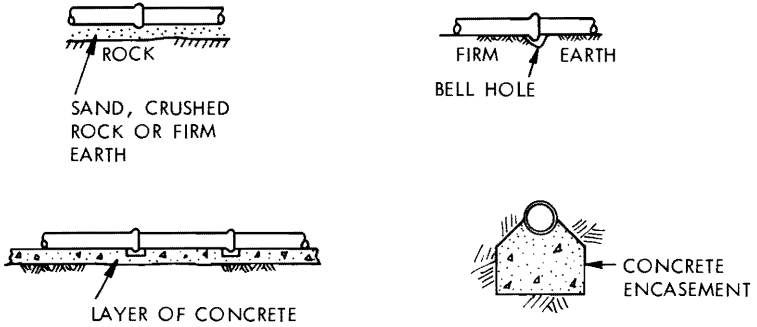

(a) Permitted

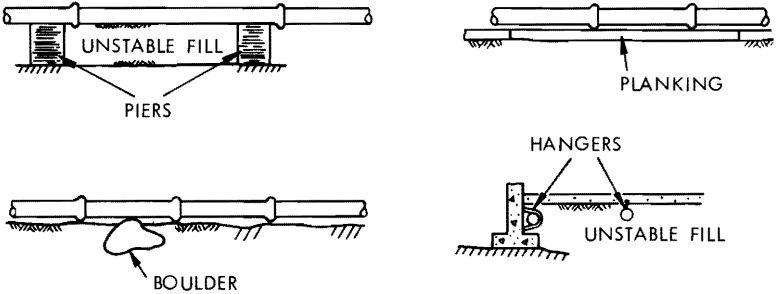

(b) Not permitted

See explanation for Subsection 3.5 for additional protection required for underground pipes. Permitted installations are shown in diagram (a). The methods of support shown in diagram (b) are not permitted because the base does not provide firm and continuous support for the pipe.

Article 3.5.1. BACKFILLING OF PIPE TRENCH

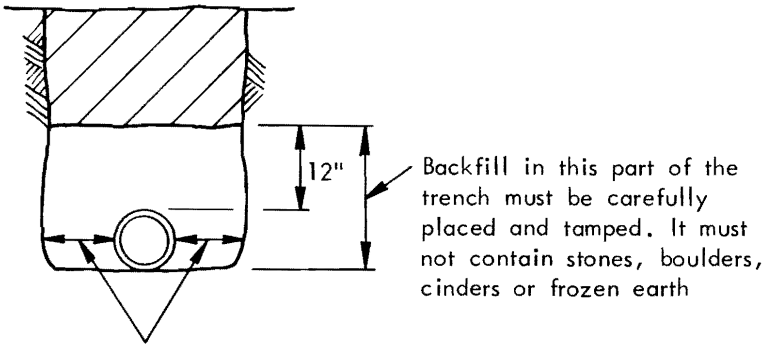

Backfill in this part of the trench must be carefully placed and tamped. It must not contain stones, boulders, cinders or frozen earth

This part of the trench should be as narrow as proper jointing and backfill will permit

Stronger pipes may be required in deep fill or under driveways, parking lots, etc., and compaction for the full depth of the trench may be necessary.

Article 3.5.2. PROTECTION OF UNDERGROUND NON-METALLIC PIPES

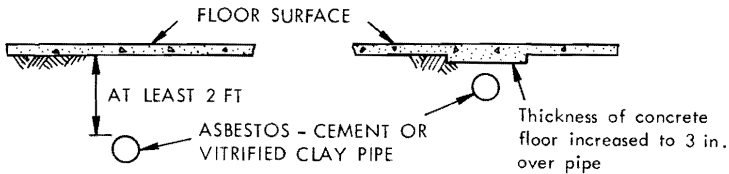

(a) Concrete floors less than 3 in. thick

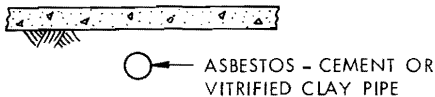

(b) Concrete floor 3 in. or more in thickness (no protection required)

Clauses 4.2.1.(1)(a) and (d) INDIRECT CONNECTIONS

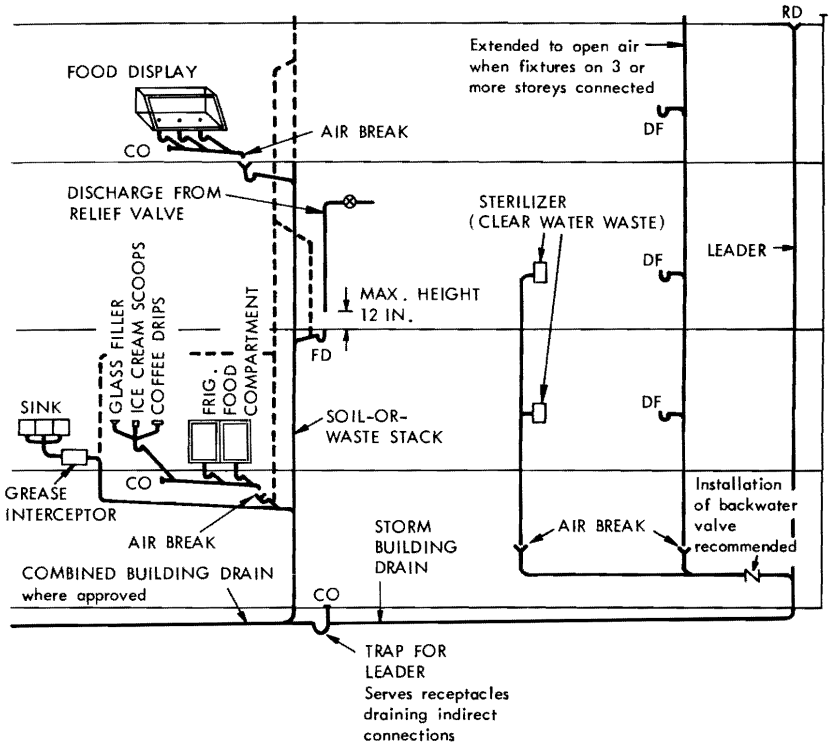

See Sentence 4.5.1.(4) for trapping requirements for indirectly connected fixtures.
 See Sentence 4.7.1.(4) for cleanouts on drip pipes for food receptacles or display cases.

Clauses 4.2.1.(1)(f) and (g) FIXTURE CONNECTIONS TO VENT PIPES

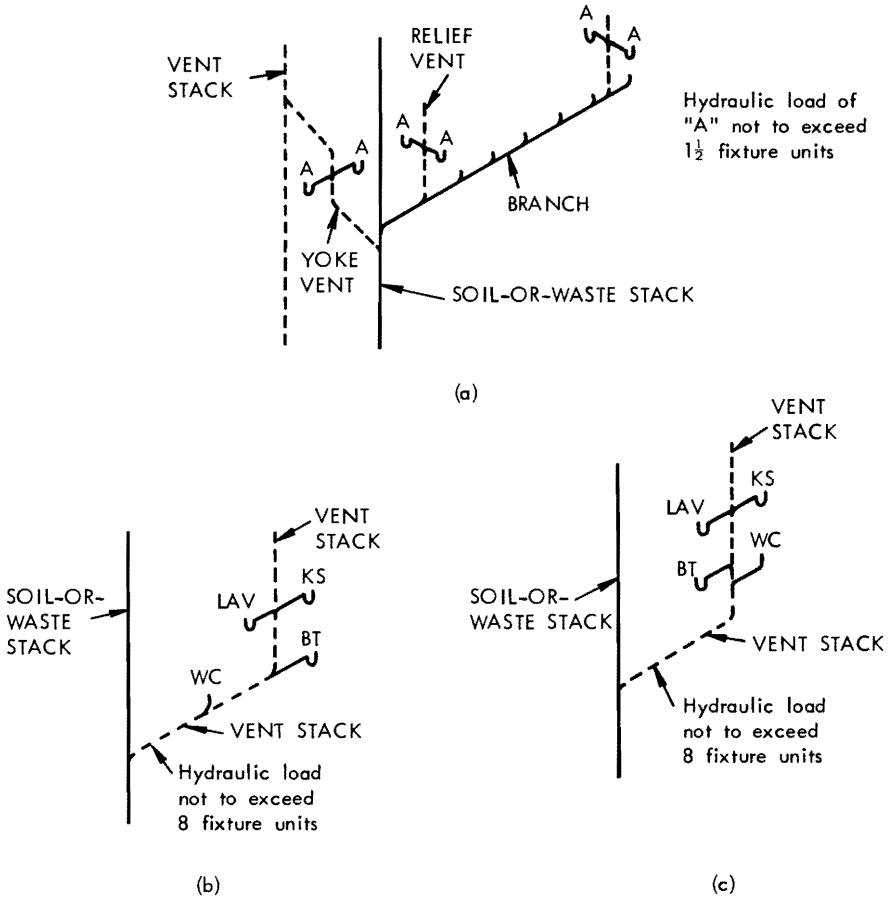

When 1 or more fixture drains are connected to a vent pipe, the vent pipe becomes a wet vent. It must then conform to all the requirements that can apply to it as a drainage pipe and a vent pipe.

Sentence 4.5.1.(2) TRAPPING OF SINKS AND LAUNDRY TRAYS

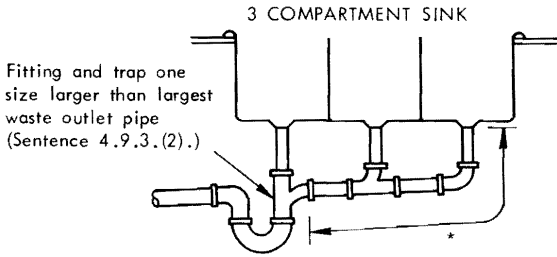

(a)

* DEVELOPED LENGTH not to exceed 36 in. (0.9 m) (Article 4.8.2.)

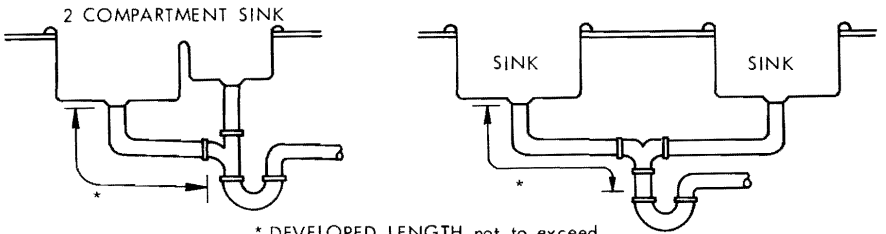

* DEVELOPED LENGTH not to exceed 36 in. (0.9 m) (Article 4.8.2.)

(b)

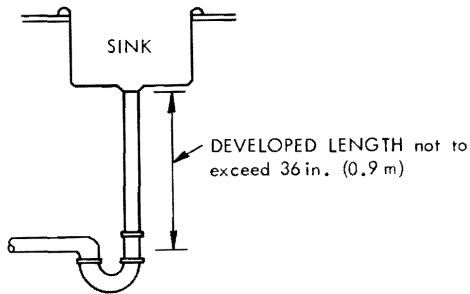

(c)

Sentence 4.5.1.(5)

An interceptor that replaces a trap must be vented in the same way as the trap it replaces. (See explanation for Clauses 4.2.1.(a) and (d). Where an interceptor other than an oil interceptor serves a group of fixtures requiring more than one trap, each fixture must be properly trapped and vented. (See Article 5.4.2 for venting of oil interceptors.)

Sentence 4.5.2.(1)

When an untrapped leader drains to a combined building sewer, clearance requirements are the same as for vent terminals. (See explanation for Sentence 5.5.5.(3).)

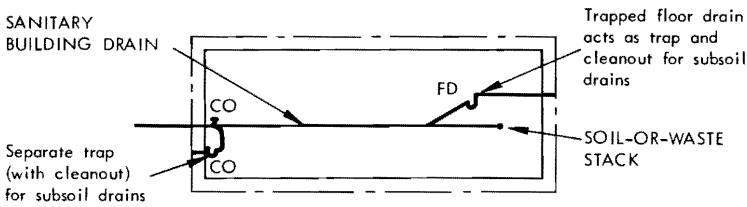
Article 4.5.3. SUBSOIL DRAINAGE CONNECTIONS

(a) Connections to sanitary drainage system (Plan View)

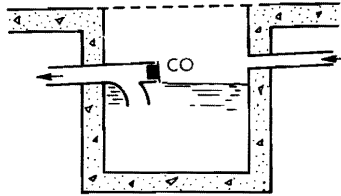

(b) Trapped sump

This Code does not regulate the installation of subsoil drainage pipes, but does regulate the connection of such pipes to the plumbing system. The intent of this Article is to place a trap between the subsoil drainage pipe and the sanitary drainage system. The cleanout must be installed in accordance with Sentence 4.7.2.(2). A trap or sump may be provided specifically for the subsoil drains, or advantage may be taken of the trap of a floor drain or storm water sump as shown above.

Sentence 4.5.4.(1) LOCATION OF BUILDING TRAPS

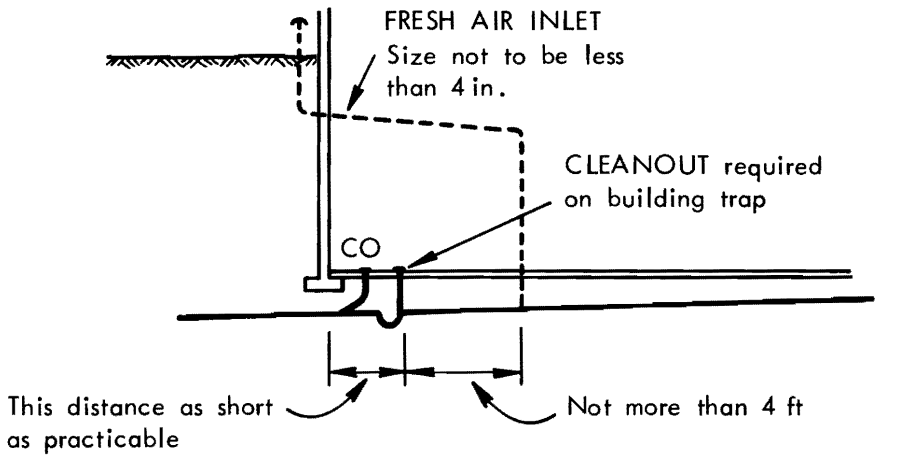

(a) Building trap inside building

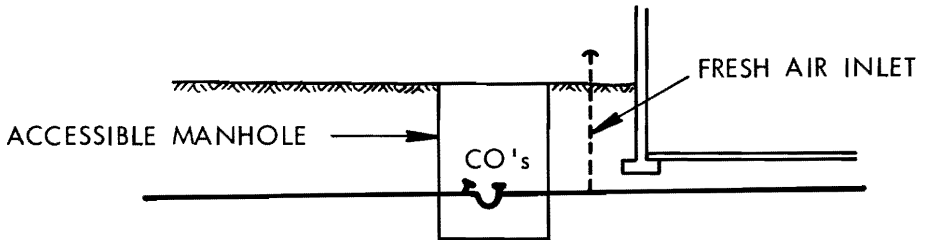

(b) Building trap outside building

Article 4.5.5. MAINTAINING TRAP SEALS

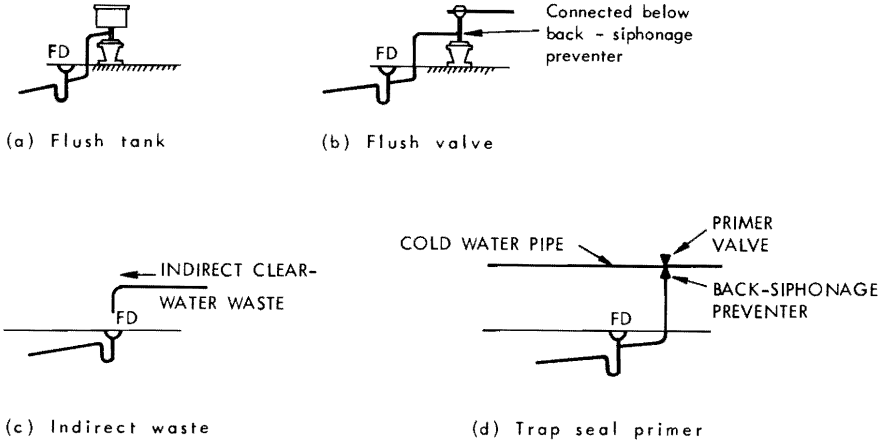

Periodic manual replenishment of the water in a trap is considered to be an equally effective means of maintaining the trap seal in floor drains in residences.

Article 4.6.3. ARRANGEMENT OF PIPING AT SUMP

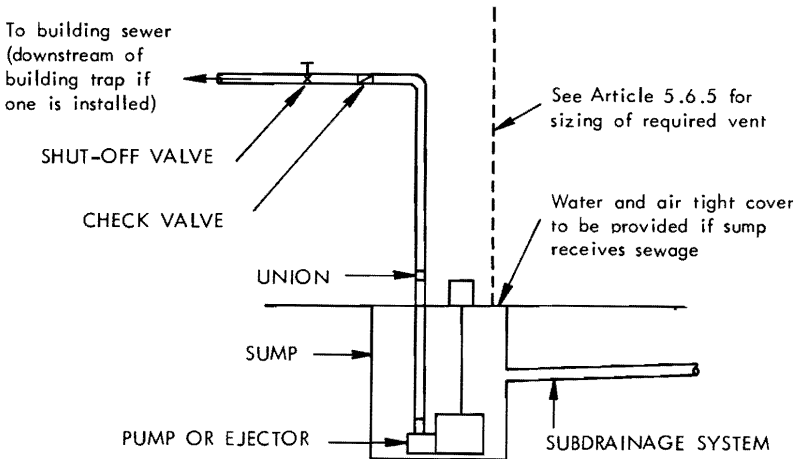

In most installations controls will be installed in conjunction with a float to automatically empty the sump. If such controls are not provided, the capacity of the sump should equal the maximum inflow to the sump that is expected to occur during any 24-hr period.

Article 4.6.4. PROTECTION FROM BACKFLOW CAUSED BY SURCHARGE

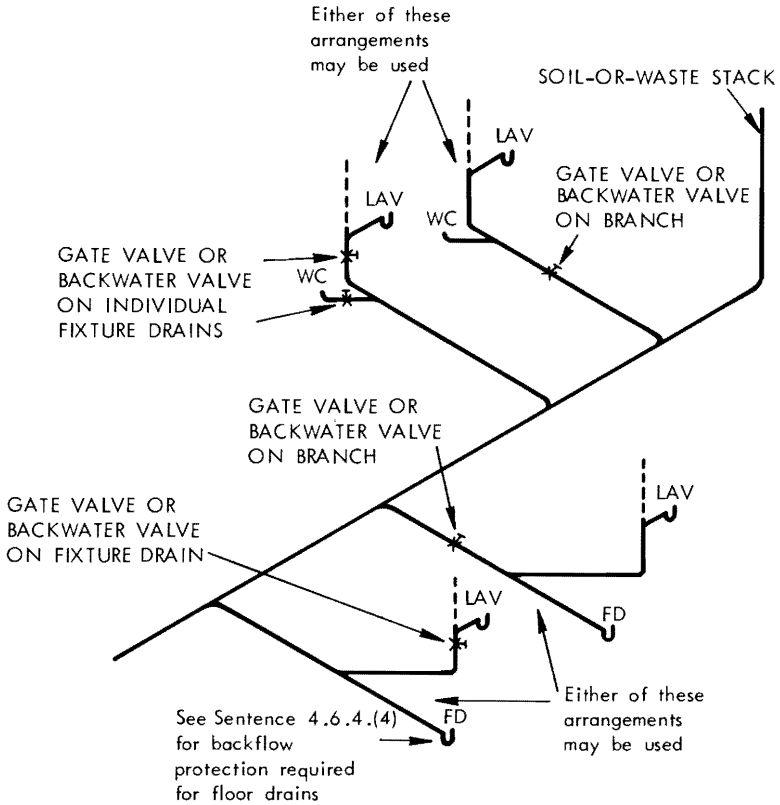

These requirements are intended to apply when in the opinion of the authority having jurisdiction there is danger of backup from a public sewer.

Sentence 4.7.1.(1)

A trap cleanout plug is not acceptable as a cleanout for the fixture drain, hence either a separate cleanout or a trap with a removable trap dip must be installed.

Sentence 4.7.1.(4) CLEANOUTS FOR FOOD RECEPTACLE DRIP PIPES

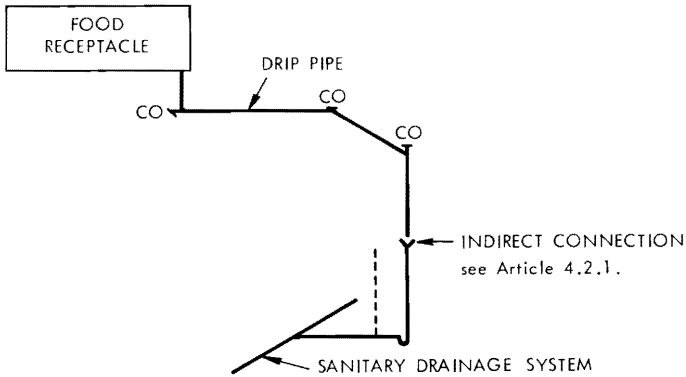

Article 4.8.1.

Although slopes below $\frac{1}{8}$ in./ft are permitted for pipes 4 in. and over, it is recommended that they be used only where necessary. Steeper slopes and higher velocities will help to keep pipes clean by moving heavier solids that might tend to clog the pipes.

Sentence 4.9.3.(2)

Fixture outlet pipes that are common to 2 or 3 compartments or fixtures are sometimes referred to as continuous wastes and are not considered to be branches. (See also explanation for Sentence 4.5.1.(2).)

Subsection 4.10 DETERMINATION OF HYDRAULIC LOADS AND DRAINAGE PIPE SIZES

Hydraulic Loads

The hydraulic load that is imposed by a fixture is represented by a factor called a fixture unit. Fixture units are dimensionless and take into account the rate of discharge, time of discharge and frequency of discharge of the fixture.

Confusion often arises when attempts are made to convert fixture units to gallons per minute because there is no straightforward relationship between the two. The proportion of the total number of fixtures that can be expected to discharge simultaneously in a large system is smaller than in a small system. For example, doubling the number of fixtures in a system will not double the peak flow that the system must carry, although of course the flow will be increased somewhat. The following curve shows the relationship that was used in constructing the tables of capacities of stacks, branches, sanitary building drains and sanitary building sewers (Tables 4.10.B. to 4.10.D.).

Subsection 4.10 (Cont'd.)

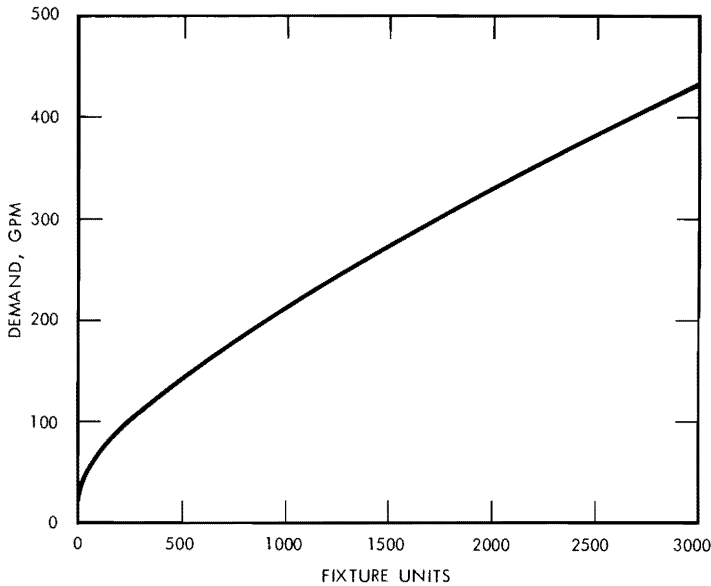

Although the above curve was used to prepare Code tables, it was not included in the Canadian Plumbing Code. Instead, a single approximate conversion factor is given in the Code so that a continuous flow from a fixture may be converted from gallons per minute to fixture units in order to determine the total hydraulic load on the sanitary drainage system. The conversion factor which is given in Sentence 4.10.3.(1) is 2 fixture units per gallon per minute. The discharge from a continuous flow fixture in gallons per minute when multiplied by 2 gives the hydraulic load in fixture units, and that load is added to the fixture unit load from other fixtures to give the total load that the sanitary drainage pipe must carry.

The hydraulic load that is produced by storm water runoff depends both on the size of the area that is drained and local rainfall intensity. The capacities of storm drainage pipes and combined sewers in Tables 4.10.E. to 4.10.G. have been expressed in terms of the number of square feet of drainage area that they can serve when the local rainfall intensity is 1 in. in 15 min. The necessary correction factor for areas where the rainfall intensity is higher or lower than 1 in. in 15 min. is provided by Sentence 4.10.5.(1) which requires that the actual area drained be multiplied by the rainfall intensity figure from NBC Supplement No. 1, "Climatic Information for Building Design in Canada 1975."

When plumbing fixtures are connected to a combined sewer, the hydraulic load from the fixtures must be converted from fixture units to square feet or, in the case of continuous flow, from gallons per minute to square feet so that these loads can be added to the hydraulic loads from roofs and paved surfaces. As already pointed out, the relationship between fixture units and gallons per minute and, consequently, the relationship between fixture units and square feet is not straightforward, and an approximate conversion factor has been adopted. The conversion factor which is

Subsection 4.10 (Cont'd.)

given in Sentence 4.10.5.(1) is 3.9 sq ft/fixture unit, except where the load is less than 256 fixture units a round figure of 1000 sq ft is to be used. In the case of continuous flow fixtures that are connected to combined sewers or storm sewers, the conversion factor given in Sentence 4.10.3.(2) is 29 sq ft/gpm. This conversion factor is not an approximation but is an exact calculation.

It should be noted carefully that the conversion factors given in Sentences 4.10.3.(1) and 4.10.5.(1) are designed to convert in 1 direction only, and must not be used to convert from fixture units to gallons per minute in the one instance nor from square feet to fixture units in the other instance.

In summary it should be noted that

- (a) in sanitary drainage systems all hydraulic loads are converted to fixture units, and
- (b) in storm drainage systems or combined drainage systems all hydraulic loads are converted to square feet.

Procedure for Selecting Pipe Sizes

The following is an outline, with examples, of the procedures to be followed in determining the size of each section of drainage piping.

1. Sanitary drainage pipes, for example, branches, stacks, building drains or building sewers
 - (a) Determine the load in fixture units from all fixtures except continuous flow fixtures,
 - (b) Determine the load in gallons per minute from all continuous flow fixtures and multiply the number of gallons per minute by 2 to obtain the number of fixture units,
 - (c) Add loads (a) and (b) to obtain the total hydraulic load on pipe in fixture units, and
 - (d) Consult appropriate table from Tables 4.10.B., 4.10.C. or 4.10.D. and select the pipe size.
(Note that no pipe size can be smaller than that permitted in Subsection 4.9.)
2. Storm drainage pipes, for example, gutters, leaders, horizontal pipes, building drains or building sewers
 - (a) Determine the area in square feet of roofs and paved surfaces according to Sentence 4.10.9.,
 - (b) Determine the local rainfall intensity (15-min. rainfall) from NBC Supplement No. 1, "Climatic Information for Building Design in Canada 1975,"
 - (c) Multiply (a) by (b) to obtain the hydraulic load in square feet,
 - (d) If a fixture discharges a continuous flow to the storm system, multiply its load in gallons per minute by 29 to obtain the hydraulic load in square feet,
 - (e) Add loads (c) and (d) to obtain the total hydraulic load on the pipe in square feet, and
 - (f) Consult the appropriate table from Tables 4.10.E., 4.10.F. or 4.10.G. and select pipe or gutter size.
(Note that no pipe size can be smaller than that permitted in Subsection 4.9.)
3. Combined drainage pipes, for example, building drains or building sewers
 - (a) Determine the total load in fixture units from all fixtures except continuous flow fixtures,
 - (b) If the fixture unit load exceeds 256, multiply it by 3.9 to determine the equivalent hydraulic load in square feet. If the fixture unit load is 256 or fewer fixture units, the hydraulic load is 1000 sq ft,

Subsection 4.10 (Cont'd.)

- (c) Obtain the hydraulic load from roofs and paved surfaces in the same manner as for storm drains (see 2(a), (b) and (c)),
 - (d) Obtain the hydraulic load in square feet from any continuous flow source that is connected to the sanitary or storm drainage system in the same manner as for storm drainage pipes (see 2 (d)),
 - (e) Add hydraulic loads (b), (c) and (d) to obtain the total hydraulic load on pipe in square feet, and
 - (f) Consult Table 4.10.E. and select the pipe size.
- (Note that no pipe can be smaller than that permitted in Subsection 4.9.)

Examples

Example I: Determination of the Size of Storm Drainage Components for Building Shown in the Following 2 Diagrams:

Storm Drainage Areas (Example I)

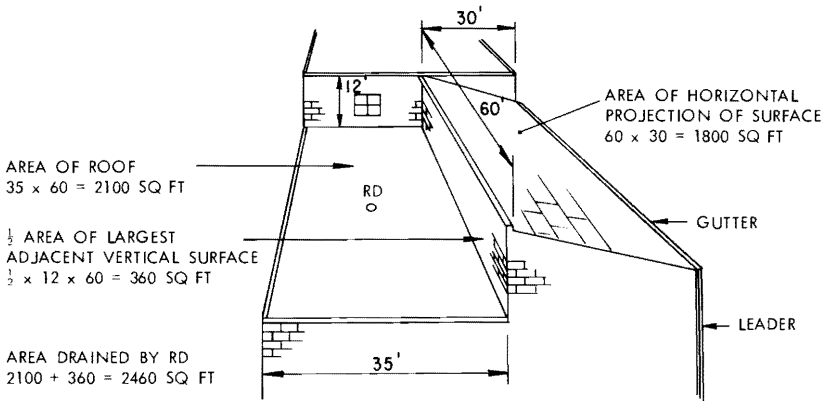

Step No. 1 Determine the hydraulic load from the roofs.

Area drained by gutter 1800 sq ft

Area drained by roof drain 2460 sq ft

If the local rainfall intensity is 1.0 in.

the load on the gutter (leader No. 2)

is (1 x 1800) 1800 sq ft

the load on the roof drain (leader No. 1)

is (1 x 2460) 2460 sq ft

If the local rainfall intensity is 0.6 in.

the load on the gutter (leader No. 2)

is (0.6 x 1800) 1080 sq ft

the load on the roof drain (leader No. 1)

is (0.6 x 2460) 1476 sq ft

Subsection 4.10 (Cont'd.)

Step No. 2 Determine the size of storm drainage components.

Using the appropriate hydraulic loads, the size of storm drainage components can be determined from Tables 4.10.E., 4.10.F. and 4.10.G. These values are tabulated in the Table below for rainfall intensities of 1 in. and 0.6 in. in 15 min.

Storm Drainage Components (Example I) (Elevation View)

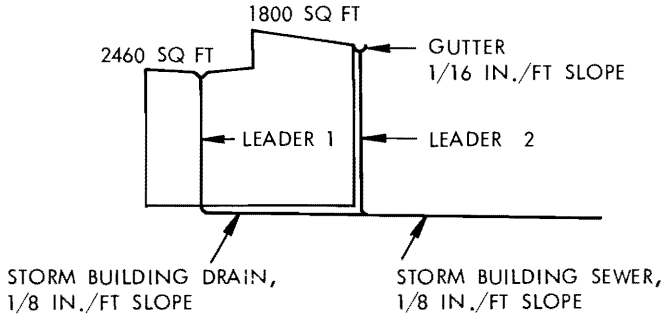

Storm Drainage Pipe Sizes (Example I)

	Area Drained, sq ft	15-min. Rainfall Intensity, in.				Reference Table No.
		1.0		0.6		
		Hydraulic Load, sq ft	Size, in.	Hydraulic Load, sq ft	Size, in.	
Roof drain leader	2460	2460	4	1476	3	4.10.G.
Gutter	1800	1800	8	1080	7	4.10.F.
Gutter leader	1800	1800	3	1080	2½	4.10.G.
Storm building drain	2460	2460	5	1476	4	4.10.E.
Storm building sewer	4260	4260	6	2556	5	4.10.E.
Column 1	2	3	4	5	6	7

Subsection 4.10 (Cont'd.)**Example II: Determination of Size of Drainage Pipes for Buildings.**

The following diagram represents an office building with washrooms for men and women, a drinking fountain and cleaner's closet on each typical floor. The equipment room with facilities is located in the basement. The building is 60 ft by 100 ft and is to be built in Kitchener, Ontario.

A. Hydraulic Load per Typical Floor

5 WC @ 6	=	30 fixture units
2 UR @ 1½	=	3 fixture units
4 LAV @ 1½	=	6 fixture units
2 FD @ 3	=	6 fixture units
1 FS @ 3	=	3 fixture units
1 DF @ 1	=	1 fixture unit
		<u>49 fixture units</u>

The reader is left to calculate the size of the branches, one of which must be 4 in. and the other 3 in. (see Subsection 4.9). Therefore the smallest part of the stack must be 4 in.

B. Hydraulic Load on Stack

5 storeys @ 49 fixture units	=	245 fixture units
------------------------------	---	-------------------

Table 4.10.B. Column 3 permits 4 in. pipe. Use 4 in. pipe

C. Hydraulic Load on Basement Branch

1 WC @ 6	=	6 fixture units
1 LAV @ 1	=	1 fixture unit
2 FD @ 5	=	10 fixture units
1 FS @ 3	=	3 fixture units
Semi-Continuous Flow		
3 gpm x 2	=	6 fixture units

Table 4.10.C. Column 2 permits 3 in. pipe. Use 3 in. pipe

Subsection 4.10 (Cont'd.) BUILDING DRAINAGE SYSTEM (EXAMPLE II.)

Roof 60 ft x 100 ft

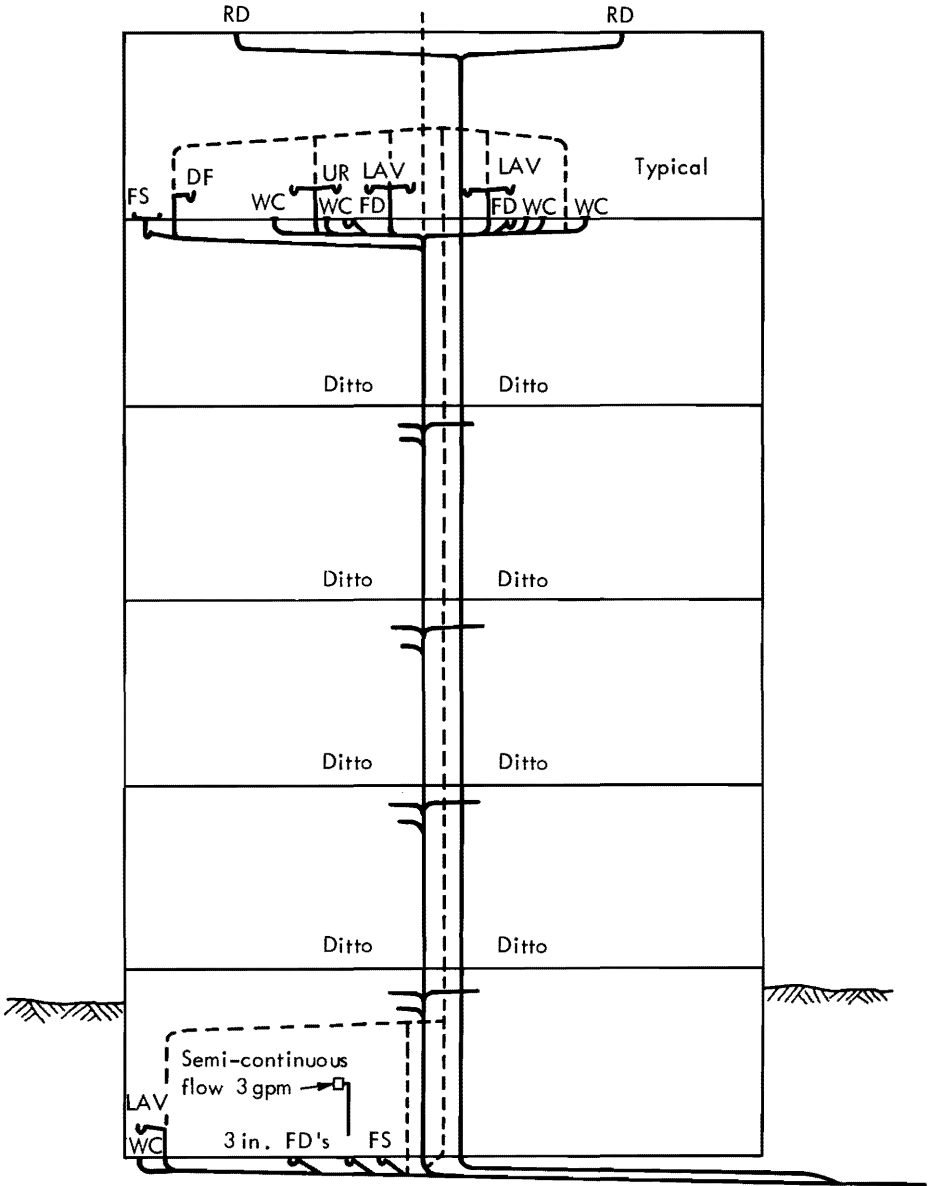

Subsection 4.10 (Cont'd.)

D. Hydraulic Load on Building Drain

From soil-or-waste stack	245 fixture units
From basement branch	<u>26 fixture units</u>
	271 fixture units

Table 4.10.D. Column 6 @ ¼ in./ft, a 4 in. pipe will carry 240 fixture units

Table 4.10.D. Column 7 @ ½ in./ft, a 4 in. pipe will carry 300 fixture units

For practical reasons use a 4 in. pipe at a slope of not less than ⅜ in./ft.

E. Storm Load

Area of roof 60 x 100 = 6,000 sq ft

Rainfall intensity for Kitchener from NBC Supplement No. 1, "Climatic Information for Building Design in Canada 1975" is 1.3 in. in 15 min.

Total hydraulic storm load = 1.3 x 6,000 = 7,800 sq ft

Storm load on each roof drain 7,800/2 = 3,900 sq ft

F. Size of Horizontal Leaders

Table 4.10.E. Column 7 @ ½ in./ft, a 4 in. pipe will carry a load of 3760 sq ft

Table 4.10.E. Column 6 @ ¼ in./ft, a 5 in. pipe will carry a load of 4720 sq ft

Table 4.10.E. Column 4 @ 3/32 in./ft, a 6 in. pipe will carry a load of 4650 sq ft

Therefore use a 4 in. pipe at a slope of slightly more than ½ in./ft.

G. Size of Vertical leader

Table 4.10.G. Column 2 would permit a 5 in. pipe (8650 sq ft) but they are not readily available. For practical reasons use a 6 in. pipe.

H. Size of Storm Building Drains

Since a drainage pipe cannot be smaller than any upstream pipes, the storm building drain must be at least 6 in. Referring again to Table 4.10.E., we see that a 6 in. pipe will carry a hydraulic load of 7550 sq ft at a slope of ¼ in./ft. Therefore use a 6 in. pipe at a slightly higher slope.

I. Size of Combined Building Sewer

(a) Total sanitary load excluding semi-continuous flow 265 fixture units converted to sq ft	
(Clause 4.10.5(1)(b)) x 3.9 =	1034 sq ft
(b) Semi-continuous flow 3 gpm converted to sq ft	
(Sentence 4.10.3(2)) x 29 =	87 sq ft
(c) Storm load	<u>7800 sq ft</u>
Total hydraulic load	<u>8921 sq ft</u>

Referring to Table 4.10.E. @ ¼ in./ft, a 6 in. pipe will carry 7550 sq ft

Referring to Table 4.10.E. @ ½ in./ft, a 6 in. pipe will carry 10700 sq ft

Therefore use a 6 in. pipe at a slope of not less than ⅜ in./ft.

Sentence 4.10.4.(1)

Climate information on rainfall intensities for various cities may be found in NBC Supplement No. 1, "Climatic Information for Building Design in Canada 1975."

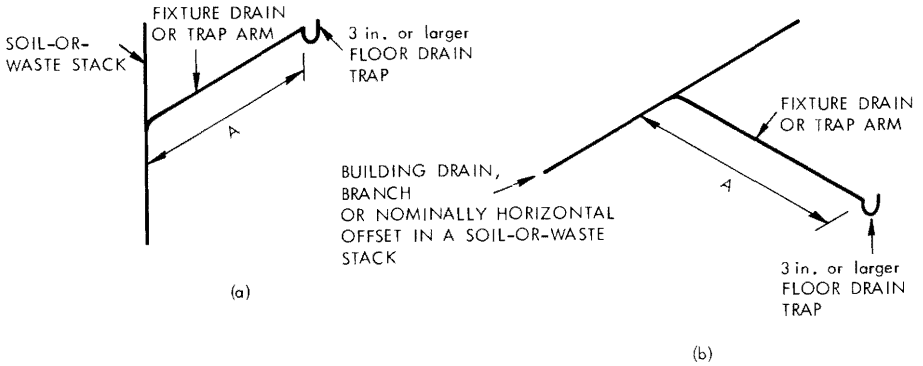
Sentence 5.1.1.(2) TRAPPING OF FLOOR DRAINS

Length of "A" must be at least 18 in. and its fall shall not exceed the size of the pipe

See also explanation of Sentence 5.5.3.(1) for fall on fixture drain

Sentence 5.1.1.(3) VENTING NOT REQUIRED

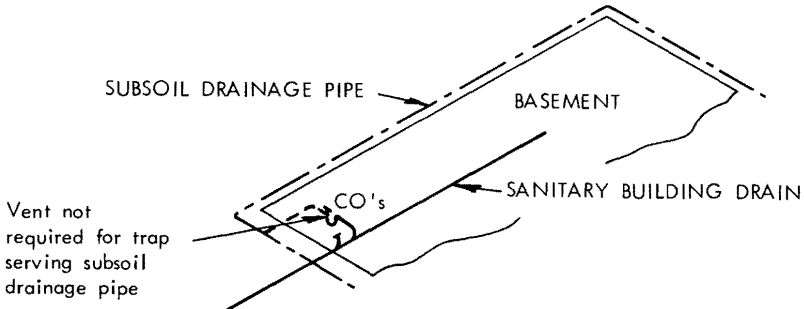

(a)

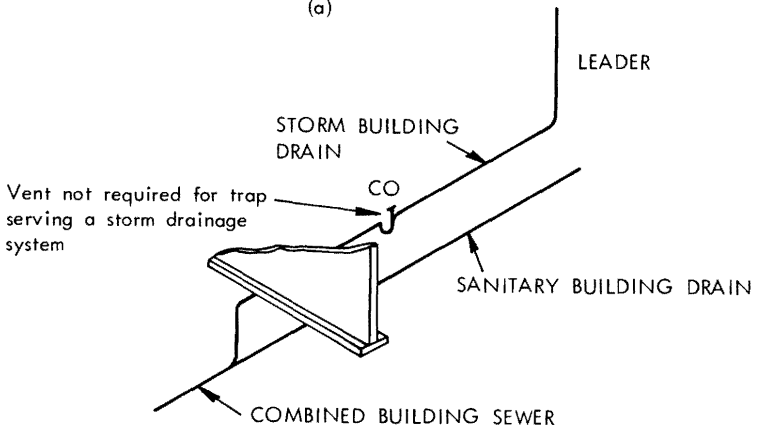

(b)

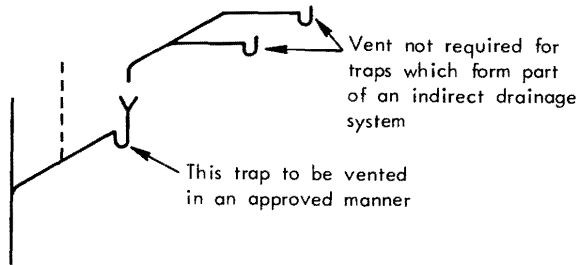

(c)

Article 5.2.1. SINGLE STOREY WET VENTING

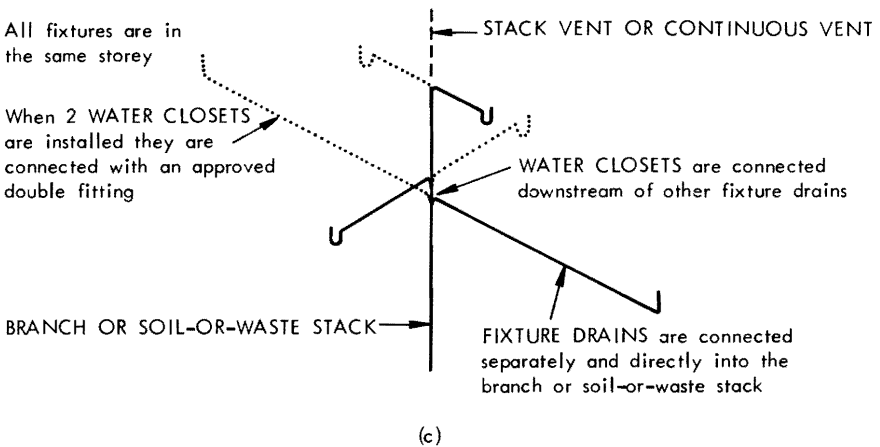
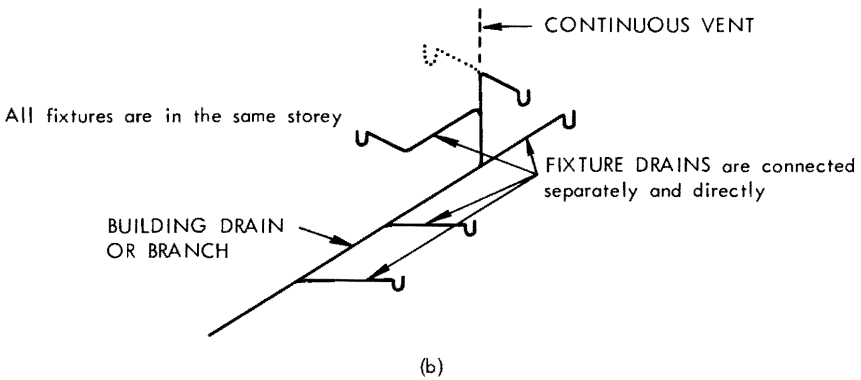
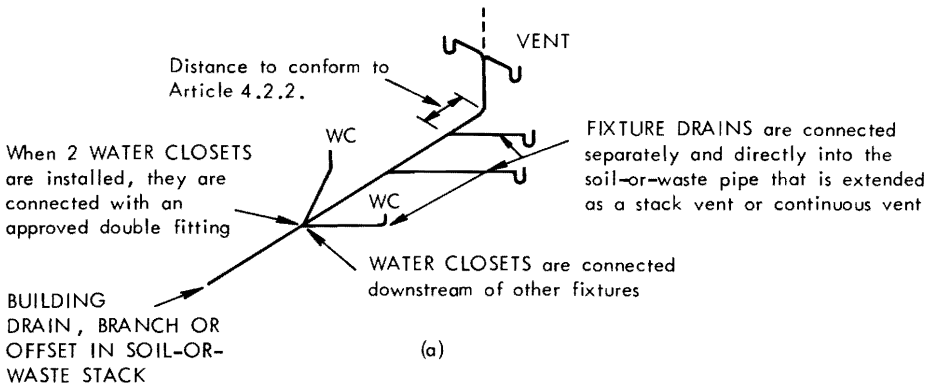

Article 5.2.2. SINGLE STOREY WET VENTING WITH CIRCUIT VENTS

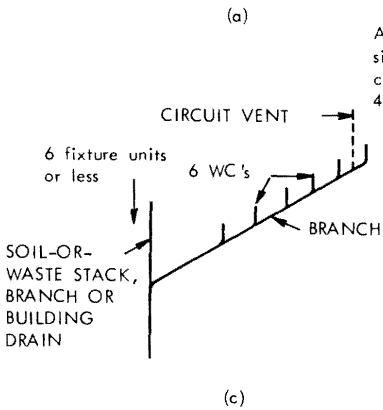
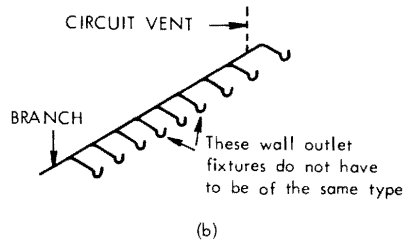
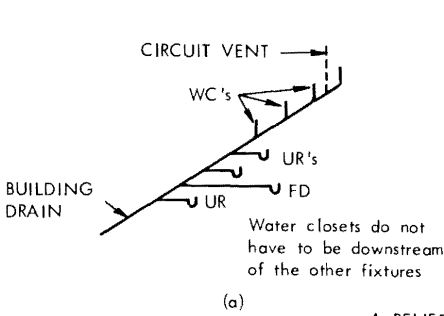

A RELIEF VENT is required since the cumulative change in direction exceeds 45 deg.

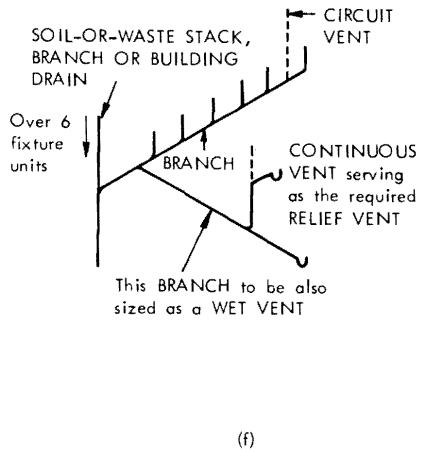
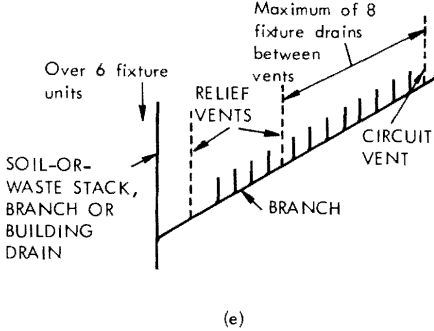
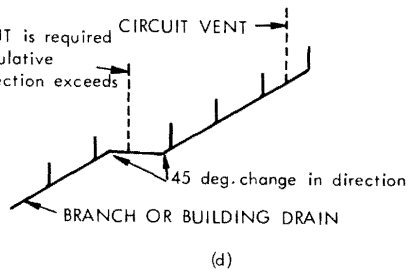

Article 5.3.1. STACK VENTS

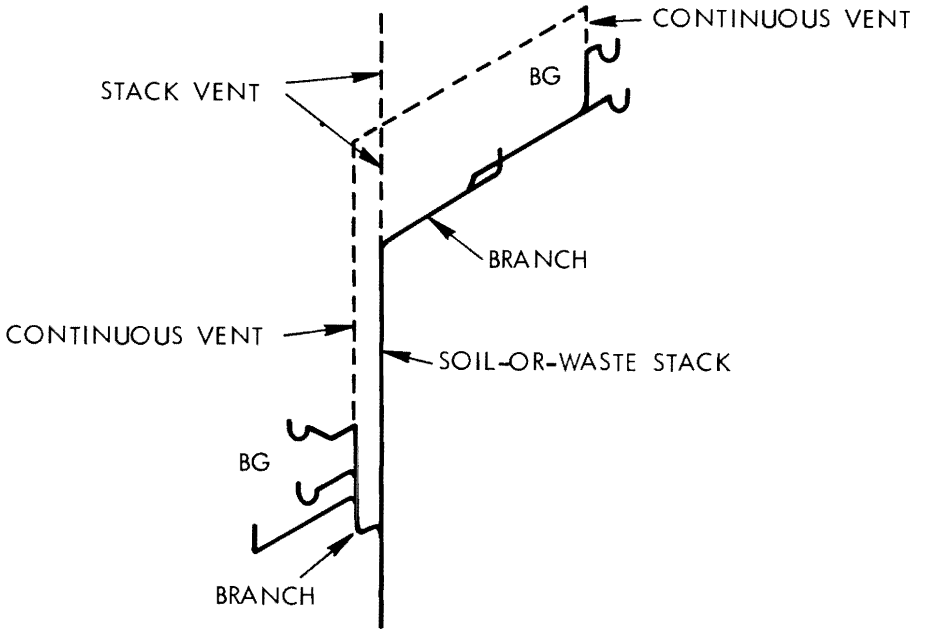

(a)

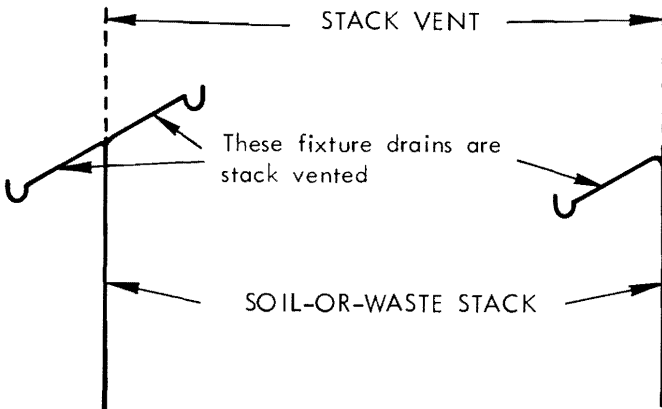

(b)

Article 5.3.2. VENT STACKS

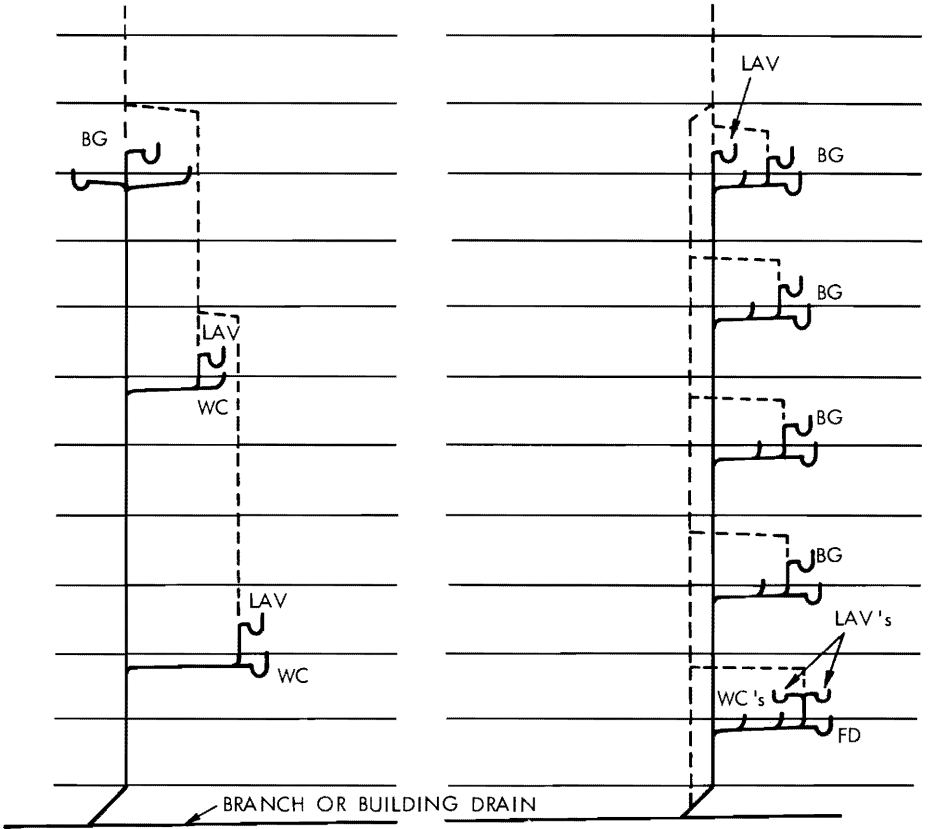

No vent stack required.
 (Fixtures draining to the
 soil-or-waste stack from
 3 storeys only)

Vent stack required.
 (Fixtures draining to
 the soil-or-waste stack
 from more than 4 storeys)

Vent stack may terminate at the lowest soil-or-waste connection or immediately below it or it may terminate at the junction of soil-or-waste stack and branch or building drain. The vent stack may also be connected at its lower end to the soil-or-waste stack below the lowest soil-or-waste pipe connection.

Sentence 5.5.2.(2) VENT PIPE CONNECTIONS

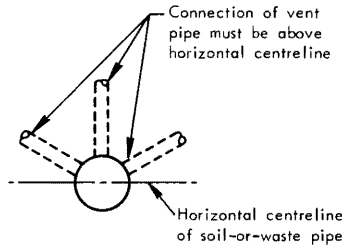

Fittings used to connect vent pipes to nominally horizontal soil-or-waste pipes are specified in Subsection 2.4.

Sentence 5.5.3.(1) VENT CONNECTIONS

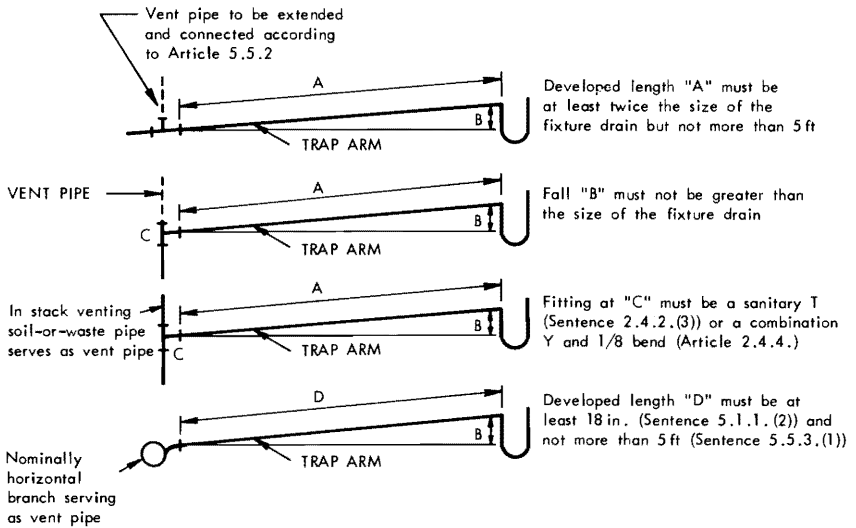

Clause 5.5.3.(1)(c) and Sentence 5.5.3.(2) LOCATION OF VENT PIPES

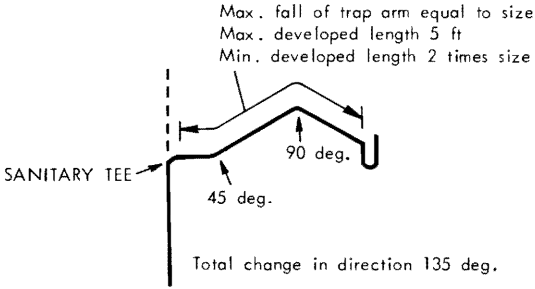

(a)

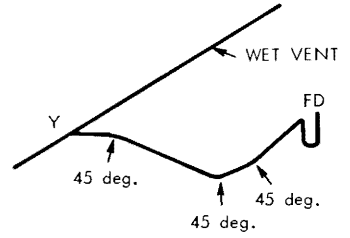

(b)

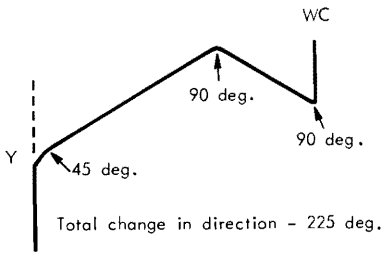

(c)

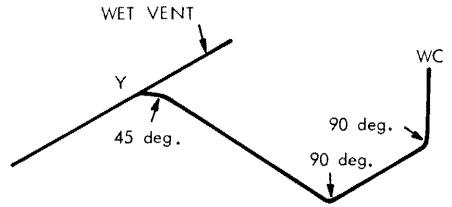

(d)

Sentence 5.5.3.(3) LENGTH OF WC FIXTURE DRAIN

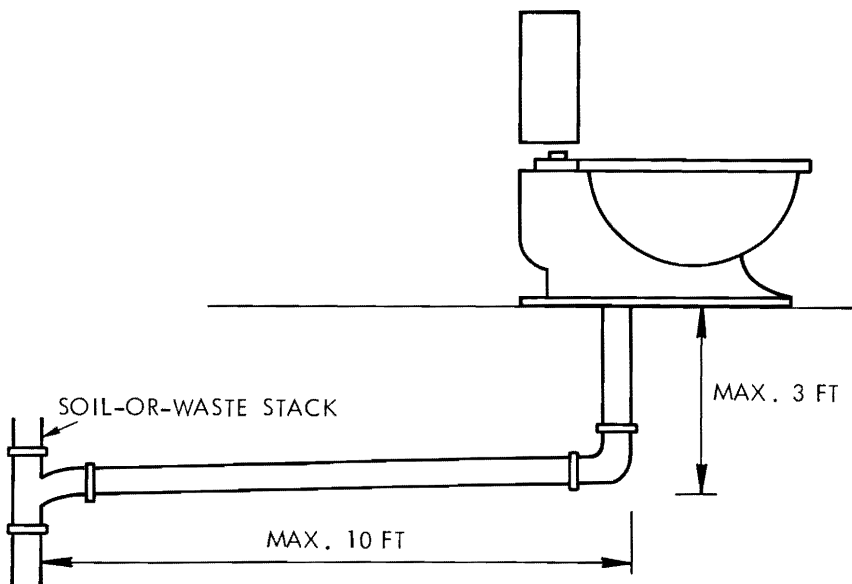

Sentence 5.5.5.(3) VENT TERMINALS

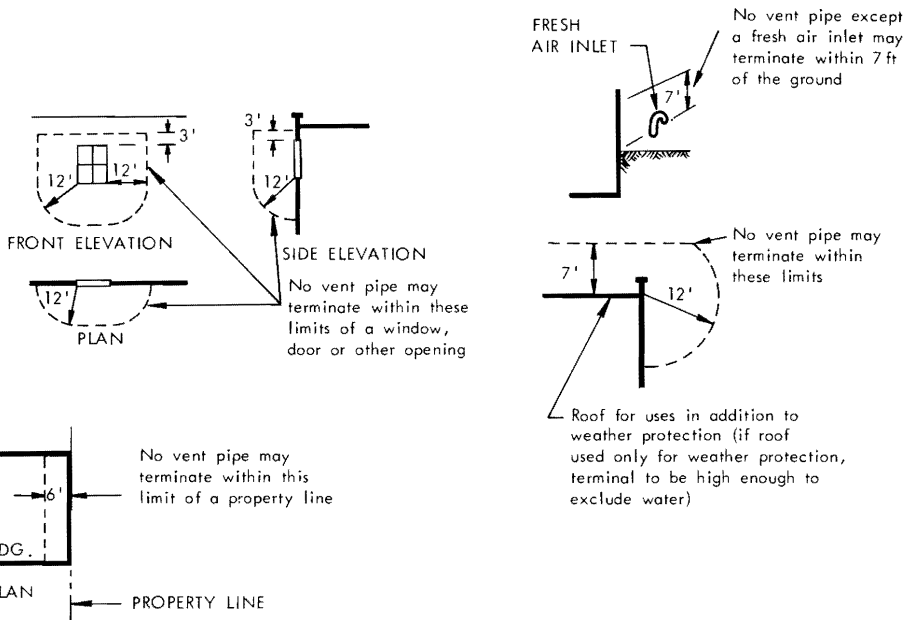

Subsection 5.7 SIZING OF BUILDING VENTING SYSTEMS

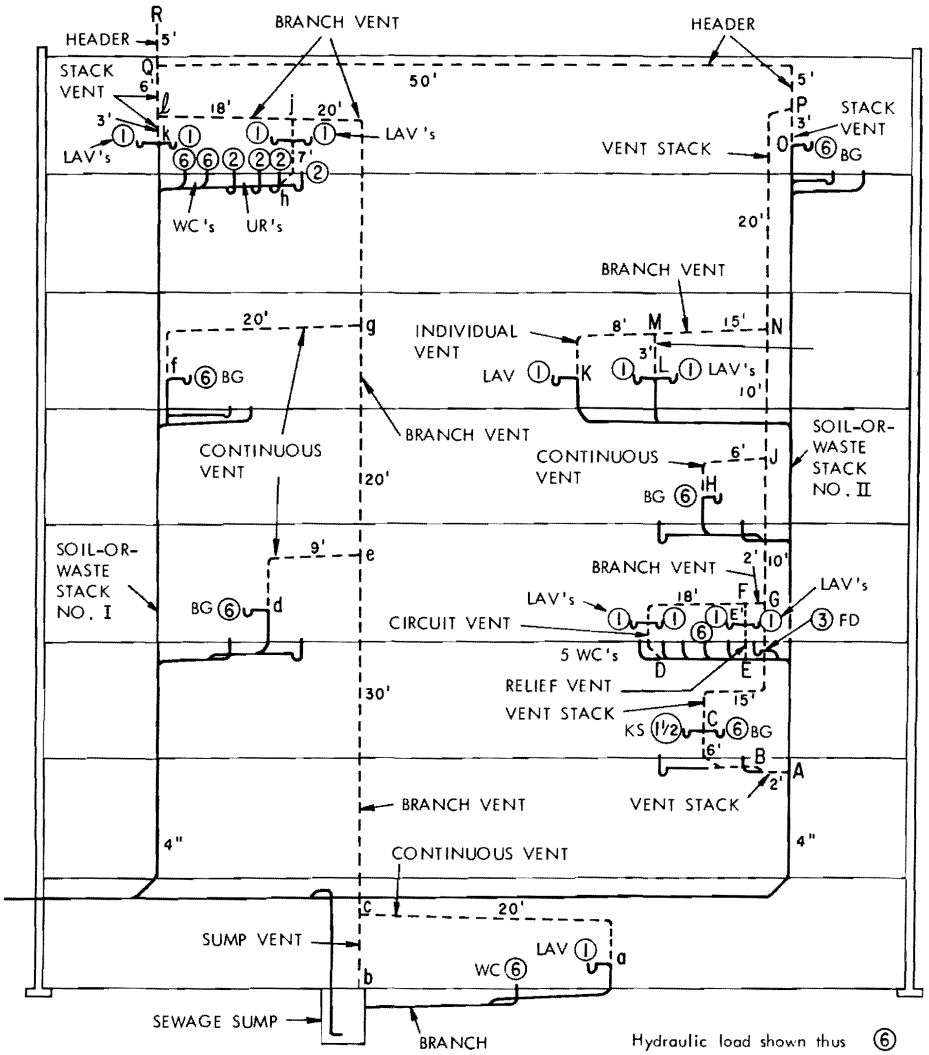

Subsection 5.7 (Cont.) TABLE OF VENT PIPE SIZES

Vent Pipe	Developed Length Used to Determine Size, ft	Hydraulic Load Used to Determine Size, fixture units	Code Reference to be Considered	Minimum Size, in.(1)	Vent Pipe Section	Developed Length Used to Determine Size, ft	Hydraulic Load Used to Determine Size, fixture units	Code Reference to be Considered	Minimum Size, in.(1)
Continuous vent (ac)	108 (acegjl)	7	5.6.1. 5.7.2.(1) 5.7.2.(2)	2	Vent Stack Section (AB)(2)	123 (ABCGJNPQR)	59½	4.2.1.(1)(e) 4.9.1. 5.6.1. 5.7.1. 5.7.3.(1) 5.7.3.(2)	3
Sump vent (bc) Branch vent (ce)	N/A 108 (acegjl)	7 7	5.6.5. 5.6.1. 5.6.2. 5.7.2.(1) 5.7.2.(4)	2½ 2½	Vent Stack Sections (BC)(CG) (GJ)(JN)(NP)(2)	123 (ABCGJNPQR)	59½	5.6.1. 5.7.3.(1) 5.7.3.(2) 4.2.1.(1)(e) 5.6.1. 5.7.1. 5.7.2.(1) 5.7.2.(5)	2½ 1½ 1½
Continuous vent (de)	67 (deglj)	6	5.6.1. 5.7.2.(1) 5.7.2.(2)	1½ 1½	Circuit vent (DF)	20 (DFG)	32	5.6.1. 5.7.1. 5.7.2.(1) 5.7.2.(5)	1½
Branch vent (eg)	108 (acegjl)	13	5.6.1. 5.6.2. 5.7.2.(1) 5.7.2.(4)	2½	Relief vent (EF)(3)	N/A	34	4.2.1.(1)(e) 5.2.2. 5.6.1. 5.6.3.	1½
Continuous vent (fg)	58 (fgjl)	6	5.6.1. 5.7.2.(1) 5.7.2.(2)	1½ 1½	Branch vent (FG)	20 (DFG)	34	5.6.1. 5.7.2.(1) 5.7.2.(4)	1½ 1½
Branch vent (gg)	108 (acegjl)	19	5.6.1. 5.6.2. 5.7.2.(1) 5.7.2.(4)	2½	Continuous vent (HJ)	6 (HJ)	6	5.6.1. 5.7.2.(1) 5.7.2.(2)	1½ 1¼
Circuit vent (hj)	25 (hjl)	22	4.2.1.(1)(c) 5.6.1. 5.7.1. 5.7.2.(1) 5.7.2.(3)	1½ 1½ 1½	Individual vent (KM) Dual vent (LM) Branch vent (MN)	N/A N/A 23 (KLMN)	1 2 3	5.6.1. 5.6.1. 5.6.1. 5.7.2.(1) 5.7.2.(4)	1¼ 1¼ 1¼ 1¼
Branch vent (jl)	108 (acegjl)	41	5.6.1. 5.7.2.(1) 5.7.2.(4)	3	Stack vent (OP)	63 (OPQR)	59½	5.6.1. 5.7.3.(1) 5.7.3.(2)	2½
Stack vent (ki)	14 (kiQR)	36	5.6.1. 5.7.3.(1) 5.7.3.(2)	2	Header (PC)	123 (ABCGJNPQR)	59½	5.6.1. 5.7.2.(1) 5.7.2.(5)	3
Stack vent (lQ)	14 (kiQR)	43	5.6.1. 5.6.2. 5.7.3.(1) 5.7.3.(2)	3	Header (QR)	123 (ABCGJNPQR)	102½	5.6.1. 5.7.2.(1) 5.7.2.(5)	4
Column 1	2	3	4	5	Column 6	7	8	9	10

Notes to Table:

- (1) The minimum size is shown opposite the Code reference(s) that governs.
- (2) Since all the fixtures protected by this vent stack drain to soil-or-waste stack No. II, all parts (AB), (BC), etc. have the same minimum size. This size depends on the load on the soil-or-waste stack regardless of whether separate vents are required. Because a WC is connected to it, Section AB must be 3 in.
- (3) Relief vent EF could be considered to be Continuous Vent EF, in which case EE' would be sized as a wet vent, and would still be 1½ in., since Article 5.6.1. governs.

Article 5.7.1. SIZING OF SINGLE STOREY WET VENT SYSTEMS

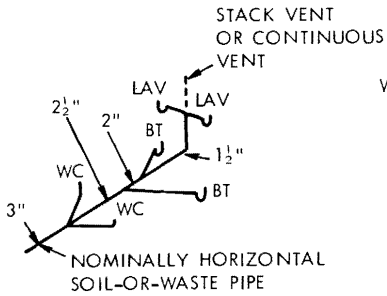

(a)

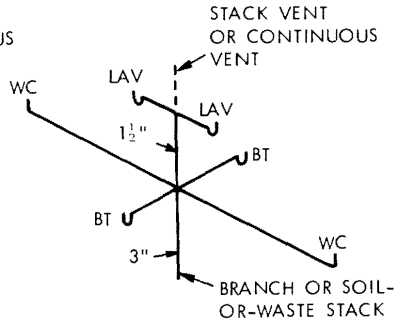

(b)

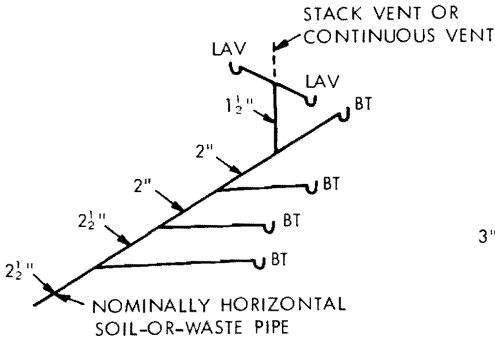

(c)

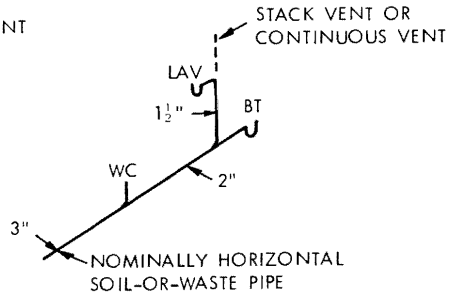

(d)

Articles 5.7.2. and 5.7.3. LENGTHS TO BE CONSIDERED WHEN SIZING VENT PIPES

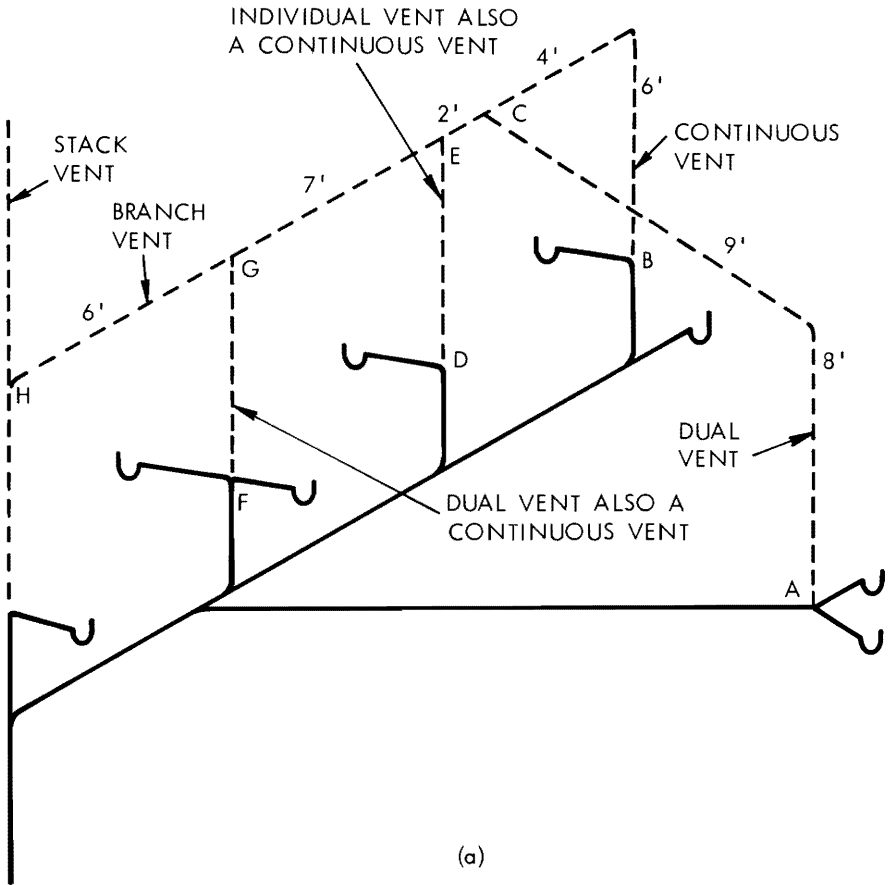

(a)

<u>VENT</u>	<u>LENGTH TO BE CONSIDERED</u>	<u>REFERENCE</u>
Dual vent AC	N/A	5.7.2 (1)
Continuous vent BC	BCEGH $6 + 4 + 2 + 7 + 6 = (25)$	5.7.2 (2)
Individual vent DE	N/A	5.7.2 (1)
Dual vent FG	N/A	5.7.2 (1)
Branch vent CEGH	ACEGH $8 + 9 + 2 + 7 + 6 = (32)$	5.7.2 (4)

Articles 5.7.2. and 5.7.3. (Cont'd)

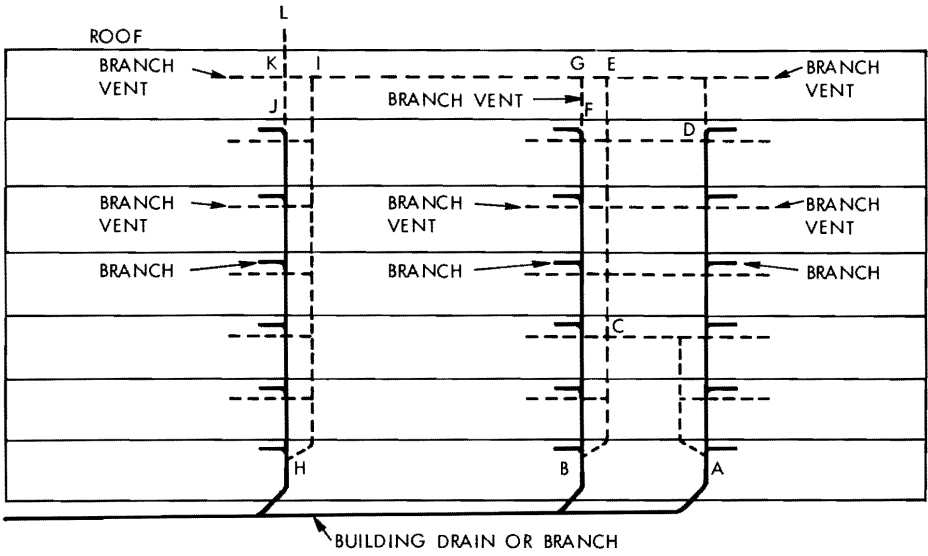

<u>VENT PIPE</u>	<u>LENGTH TO BE CONSIDERED</u>	<u>REFERENCE</u>
Vent stack (AC)	ACEGIKL	5.7.3.(2)
Vent stack (BC)	BCEGIKL	5.7.3.(2)
Vent stack (HI)	HIKL	5.7.3.(2)
Stack vent (DE)	DEGIKL	5.7.3.(2)
Stack vent (FG)	FGIKL	5.7.3.(2)
Stack vent (JK)	JKL	5.7.3.(2)
Header (CEGIKL) (or any section of it)	ACEGIKL	5.7.2.(5)

Article 6.2.1.

Examples of equipment to which these requirements apply are residential or industrial space heating boilers to which chemicals may be added, or a sprinkler system to which antifreeze may be added. To be effective, every device installed in a potable water system for protection against backflow must be maintained in good working condition. See explanation for definition for backflow preventer and for back-siphonage preventer (vacuum breaker).

Clause 6.2.3.(3)(b)

See explanation for Article 6.2.5. for illustration of the use of nonpressurized fixtures and also explanation for illustration of a back-siphonage preventer.

Sentence 6.2.4.(1)

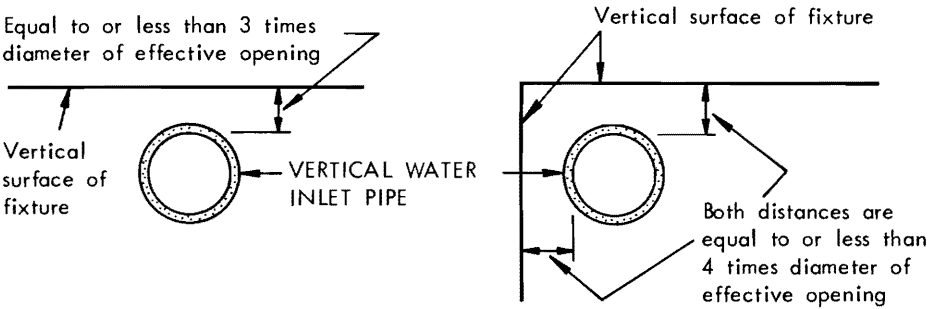

Where the inlet is located as shown above, the height of the air gap shall be not less than 3 times the diameter of the effective opening.

Sentence 6.2.5.(1) INSTALLATION OF AIR GAPS AND BACK-SIPHONAGE PREVENTERS

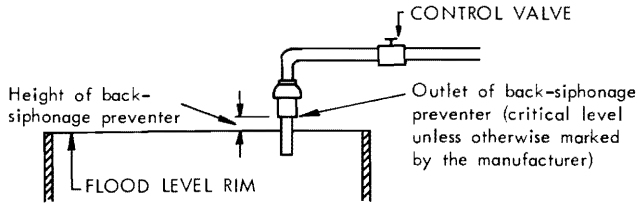
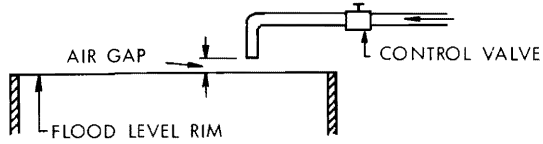

(a) Above flood level rim

Overflow must have sufficient capacity so that, if all outlets are plugged and all inlets are open, water level will not be more than one-half of air gap above top of overflow

Indirect connection
Sentence 4.2.3.(1)

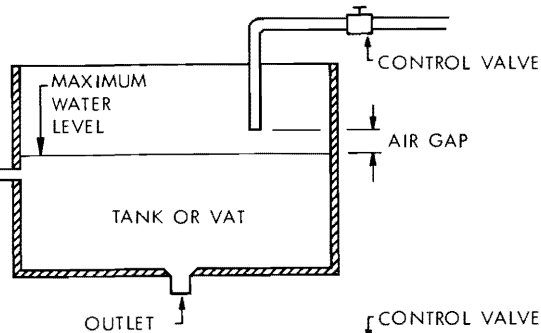

Overflow must have sufficient capacity so that if all outlets are plugged and all inlets are open, height of water level above top of overflow will not exceed size of inlet pipe

Indirect connection
Sentence 4.2.3.(1)

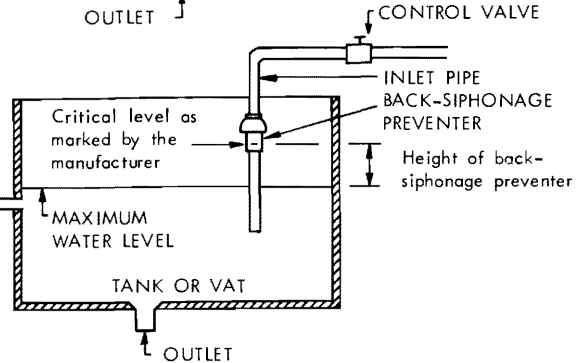

(b) In tank or vat

Subsection 6.5

This Subsection contains performance requirements for water systems. Two widely used references for the design of water systems are:

“Water-Distributing Systems for Buildings” by R. B. Hunter, Building Materials and Structures Report BMS 79, United States Department of Commerce, National Bureau of Standards, Washington, D.C., 1941, and

“National Plumbing Code Handbook” edited by V. T. Manas, McGraw-Hill Book Company, New York, U.S.A. 1957.

INDEX

A

- Abbreviations
 - of organizations and authorities, 6
 - of words and phrases, 6
- Acrylonitrile-butadiene-styrene (ABS) pipe, 12, 21
- Administration, 1, 7-9
- Air breaks, 20, 25
- Air chambers (shock stops), 43
- Air gaps, 44
- Air tests, 22, 23
- Ancillary buildings, 7
- Application of Code, 1
- Approval, certificate of, 8
- Asbestos-cement pipe and fittings, 11, 21
- Aspirators, 44

B

- Backfill for piping, 21
- Backflow
 - preventers, 43, 44
 - protection from, 27, 44, 45
- Back-siphonage preventers, 17, 43-45
- Backwater valves, 27
- Ball tests, 22, 23
- Bituminized-fibre pipe and fittings, 11
- Branches
 - hydraulic load on, 33
 - serving water closets, 29
- Branch vents, 39
- Brass floor flanges, 16
- Brass pipe, 14
- Brass pipe flanges and fittings, 14
- Bronze pipe flanges and fittings, 14
- Building drains
 - cleanout for, 28
 - combined, 26, 27, 34
 - hydraulic load on, 33-34
 - protection of, from backflow, 27
 - protection of, from damage, 21-22
 - size of, 29, 34
- Building sewers
 - combined, 28, 34
 - hydraulic load on, 33-34
 - size of, 34
 - slope of, 34
- Building traps, 10
 - cleanout for, 26
 - fresh air inlets for, 37
 - location of, 26
- Burned lead joints, 18, 19

C

- Cast-iron soil pipe and fittings, 13, 19, 21
- Cast-iron water pipe and fittings, 13, 21
- Caulked lead drainage joints, 17
- Caulking compounds, cold, 16, 19
- Caulking lead, 16
- Cement jointing mortar, 16
- Cement joints, 18
- Cement-mortar lining, 13
- Certificate of approval, 8
- Check valves, 23, 27
- Chlorinated poly (vinyl chloride) (CPVC) pipe and fittings, 12
- Circuit vents, 39
- Cleaning of water systems, 44
- Cleanout, 16, 26, 27-28
 - fittings, 16
 - for traps, 28
 - installation of, 27-28
 - location of, 28
 - rodding of, 28
 - size of, 28
 - types of, 16
- Climatic data, 32
- Cold caulked joints, 19
- Combination Y and $\frac{1}{8}$ th bend, 11
- Combined building drains, 34
 - restricted use of, 27
- Combined building sewers, 28, 34
- Combined temperature and pressure relief valves, 17
- Combustible piping, 12
- Compounds, caulking and sealing, 16
- Concrete pipe and fittings, 11
- Connections
 - direct, 23, 24-25
 - fixture, 23, 24
 - indirect, 24
 - running thread and packing nut, 19
 - to drainage systems, 23-25
 - to lead bend, 24
 - to nominally horizontal offset, 24
 - to nominally horizontal soil-or-waste pipe, 24
 - to vent stack, 24
- Continuous vents, 39
- Cooling of hot waste, 25
- Copper pipe, 14
- Copper tube, 14-15, 20
- Corrugated steel pipe and fittings, 14
- Couplings, mechanical pipe, 16
- CPVC (see Chlorinated poly (vinyl chloride) pipe)
- Cross fittings, 10

D

- Dead ends in piping, 27
- Definitions, 1-5
- Developed length
 - of fixture outlet pipes, 29
 - of vents, 37-38
- Direct flush valves, 16
- Dissimilar materials, joints for pipes
 - of, 19-20
- Double Y or combination Y and 1/8th bend fittings, 11
- Drains (see Building drains, Fixture drains, Roof drains)
- Downspouts (see Leaders)
- Drainage joint, caulked lead, 17
- Drainage piping, 13
 - arrangement of, 27
 - hydraulic loads on, 31-35
 - location of, 27
 - minimum slope of, 29
 - sizing of, 29
- Drainage systems
 - connection of, 23-25
 - sanitary, 25, 27
 - storm, 23, 26, 27, 34
 - testing of, 22-23
- Drain valves, 42
- Drilled and tapped joints, 19
- Drinking fountains, 23, 44
- Drinking fountain bubblers, 16
- Drip valves, 42
- Dual vents, 38

E

- Eavestroughs (see Gutters, roof)
- Effective opening, 44
- Ejectors, 43
- Electrical insulation at piping supports, 20
- Equivalent materials, 7
- Expansion and contraction, piping system, 20

F

- Facilities required, plumbing, 7
- Ferrous pipe and fittings, 13-14
- Fittings, 10-15
 - brass or bronze, 14
 - butt-fusion, 12
 - cast-iron, 13
 - concrete, 11
 - cross, 10
 - double Y, 11
 - ferrous, 13-14
 - flared joint, 15
 - insert, 12
 - malleable iron, 13

- marking of, 9
 - non-ferrous, 14-15
 - non-metallic, 11-12
 - restrictions on use of, 10-11, 37
 - screwed, 13
 - single or double combination Y, 11
 - single or double sanitary T, 10
 - sisson, 11
 - solder-joint, 15
 - supply and waste, 16
 - T-type, 10
 - vitriified clay, 11
- Fixtures**
- connections of, 23-25
 - construction of, 9-10
 - hydraulic load from, 31-35
 - indirectly connected, 20, 24, 26
 - installation of, 7, 20, 25, 42
 - location of, 7, 25
 - materials for, 9-10
 - special purpose, 9
 - specifications for, 9-10
- Fixture drains**
- cleanouts for, 28
 - connections of, to wet vents, 36, 38
 - fall on, 37
 - fixture traps for, 37
 - for floor outlet fixtures, 20
 - for indirectly connected fixtures, 24
 - minimum slope of, 29
 - protection of, from backflow, 27
 - size of, 34
 - venting of traps for, 35
- Fixture outlet pipes**
- developed length of, 29
 - size of, 29, 30
- Fixture units, conversion to square feet, 32**
- Flanges**
- floor, 16, 20
 - water closet, 16
- Flared joint fittings, 15**
- Flared joints, 18**
- Flashing, vent pipe, 17**
- Floor drains**
- connections of, to drainage systems, 25, 26
 - protection of, from backflow, 27
 - traps for, 35
- Floor outlet fixtures, drain connections, 20**
- Flow control roof drain, 32**
- Flushing devices, 16, 42**
- Freezing, protection from, 22, 42**
- Fresh air inlets, 37**

G

- Galvanized steel pipe, 13-14
- Garbage grinders, 25

Grease interceptors (see Interceptors)
 Groove and shoulder mechanical pipe couplings, 16
 Gutters, roof, 34, 35

H

Hangers, pipe, 20, 21
 Headers, 39-40
 Horizontal offsets (see Offsets in piping)
 Horizontal piping, support of, 21
 Hot poured joints, 18
 Hub and spigot pipe, 17, 20
 Hydraulic loads, determination of, 31-35

I

Increaser fittings, 19
 Indirect connections, 20, 24, 25
 Individual vents, 38
 Inlets, fresh air, 37
 Inspection, 8-9
 Installation of fixtures, 7, 20, 25, 42
 Insulation, electrical at piping supports, 20
 Interceptors
 capacity of, 26
 cleanouts for, 28
 design of, 10
 replacing traps, 26
 restricted use of, 25
 venting of, 37
 where required, 25

J

Joining materials, 16
 Joints, pipe, 17-20

L

Laundry trays, 9
 Lead
 caulking, 16
 flashing, 17
 waste pipe and fittings, 15, 21
 Leaders (downspouts)
 connections of, to roof drain, 20
 hydraulic load on, 35
 sheet metal, 14
 trap for, 26
 Lighting of rooms, 7
 Load, hydraulic, 31-35
 Loop vents (see Circuit vents)

M

Malleable iron water fittings, screwed, 13
 Manholes, as cleanouts, 28
 Marking of pipes and fittings, 9, 46
 Materials
 defects in, 9

equivalent, 7
 for fittings, 10-15
 for fixtures, 9-10
 for traps and interceptors, 10
 jointing, 16
 marking of, 9, 46
 miscellaneous, 16-17
 used, 9
 Mechanical joints, 19
 pipe couplings for, 16
 Mortar, cement jointing, 16

N

Nominally horizontal piping, 21
 Noncombustible piping, 12
 Non-ferrous pipe and fittings, 13-14
 Non-metallic pipe and fittings, 11-12
 Non-potable water systems, 46-47
 connections of, to potable water systems,
 43-45, 46
 identification of, 46
 location of pipes and outlets for, 46, 47

O

Offsets in piping, 24
 Oil interceptors (see Interceptors)
 Outlets, non-potable water system, 47
 Overflows
 fixture, 10
 rainwater tank, 24

P

Paved surfaces, hydraulic load from, 32
 Permits, 7-8

Pipe

acrylonitrile-butadiene-styrene (ABS), 12, 21
 applications, summary of, 11, 13, 14
 asbestos-cement drainage, 11, 21
 asbestos-cement water, 11, 21
 bituminized-fibre, 11
 brass, 14
 cast-iron soil, 13, 19, 21
 cast-iron water, 13, 21
 chlorinated poly (vinyl chloride) (CPVC), 12, 21
 combustible, 12
 concrete, 11
 copper, 14, 21
 corrugated steel, 14
 ductile-iron water, 13
 flanges and fittings, brass or bronze, 14
 galvanized steel, 13, 21
 hangers, 20, 21
 hub and spigot, 17, 20
 joints and connections, 17-20
 lead waste, 15, 21
 marking of, 9, 46

noncombustible, 12
 open end, 27
 plastic, 12, 21
 polyethylene water, 12, 42
 poly (vinyl chloride) (PVC), 12, 21
 protection of, 21-22, 43
 sheet metal, 14
 size of, 29-31
 steel, 13, 14, 21
 subsoil drainage, 26, 27
 underground (see Underground pipes)
 vitrified clay, 11-12, 21
 water supply, 42-46
 welded and seamless steel, 13

Piping
 drainage of, 42
 installation of, 20, 22
 nominally horizontal, 21
 protection of, 21-22, 42
 service, 7
 support of, 20-21

Plastic pipe and fittings, 12

Plumbing contractor, 8

Plumbing facilities required, 7

Plumbing systems
 certificate of approval of, 8
 inspection and testing of, 8
 plans and drawings for, 8
 responsibility of contractor for, 9

Polyester composite fixtures, 9

Polyethylene water pipe, 12

Poly (vinyl chloride) (PVC) pipe and fittings, 12

Potable water systems
 arrangement of piping for, 42-43
 connections of, to non-potable water systems, 43-44, 46
 design of, 45-46
 protection of, from contamination, 43-45
 tanks for, 45
 testing of, 23
 wells for, 45

Potato peelers, 25

Pressure reducing valves, 46

Pressure relief valves
 specifications for, 17
 where required, 43

Private sewage disposal systems, 25

Private water supply systems, 43

Protection of piping, 21-22, 42

PVC (see also Poly (vinyl chloride) (PVC) pipe and fittings), 12, 21

Q

Quarter bend fittings, 11

R

Rainfall, 32

Reducer fittings, 19

Relief valves
 discharge pipe for, 43
 specifications for, 17
 where required, 43

Relief vents
 connections to, 24, 36, 38
 minimum size of, 39

Risers, shut-off valves for, 42

Roof drains, 20
 flow control, 32
 leader connections for, 20

Roof gutters, 34-35

Roofs, hydraulic load from, 32

Rubber gasket joints, 13

S

Saddle hubs, 16

Sanitary building drains or sewers (see Building drains or Building sewers)

Sanitary drainage systems, 25, 27

Sanitary T-Y fittings (single or double), 10

Sanitary T fittings, 10

Scope of code, 1

Screwed cast-iron water fittings, 13

Screwed joints, 18

Screwed malleable iron water fittings, 13

Service piping, 7

Service water heaters, 43

Sewage disposal systems, private, 25

Sewage treatment and disposal, 25-26

Sewers (see Building sewers)

Sheet lead, welds in, 18-19

Sheet metal leaders, 14

Shock stops, 43

Shower receptors, 9

Shut-off valves, 27, 42

Single or double combination Y and 1/8th bend fittings, 11

Sinks
 dishwashing, 10
 food preparation, 10

Sisson fittings, 11

Size of
 cleanouts, 28
 drainage pipes, 29-31
 fixture outlet pipe, 29-31
 vent pipes, 39-41
 water supply pipes, 45-46

Slip joints, 19

Slope of drainage pipes, 29

Smoke tests, 22

Soil-or-waste pipes
 location of, 27

- size of, 29
- Soil-or-waste stacks
 - cleanouts for, 27
 - hydraulic load on, 32-33
 - size of, 29
 - vent pipes for, 36-37
- Soil pipe, cast-iron, 13, 19, 21
- Solder, wiping, 16
- Soldered joints, 18
- Solder-joint fittings, 15
- S-trap standards, installation of, 20
- Stacks, hydraulic load on, 32-33
- Stack venting, 36
- Stack vents size of, 39, 41
- Stainless steel fixtures, 9
- Stall urinals, 25
- Steel pipe (welded and seamless), 13-14
- Stop-and-waste cocks, 42
- Storage type service water heaters, 43
- Storm drainage systems
 - connection of, 23
 - hydraulic load on, 34
 - sizing of, 31-35
 - sumps for, 27
 - traps for, 26
- Stubs, lead water closet, 20
- Subsoil drainage pipes, connection of, 27
- Sumps, 27
 - venting of, 39
- Supply and waste fittings, 16
- Supports for piping, 20-21

T

- T fittings, 10
- Tanks, potable water, 45
- Temperature limit controls, 43
- Temperature relief valves
 - specifications for, 17
 - where required, 43
- Terminals, vent pipe, 38
- Testing of
 - drainage and venting systems, 22-23
 - potable water system, 23
- Threaded cast-iron drainage fittings, 13
- Trap arms, 37
- Trap seals
 - maintaining, 26
 - size of, 10
- Trap standards, installation of, 20
- Traps
 - bell, 10
 - cleanouts for, 10, 26
 - connections of, 10
 - design of, 10
 - drum, 10
 - for fixtures, 25, 26, 29, 30-31
 - for leaders, 26

- for storm drainage systems, 26
- for subsoil drains, 26
- interceptors used as, 26
- location of, 26
- venting of, 35-36, 37
- Treatment of harmful sewage and wastes, 25-26
- Tube, copper, 14-15, 20

U

- Underground pipes
 - protection of, 21-22
 - support of, 21
- Unions and slip joints, 19, 27
- Urinals
 - construction of, 10
 - installation of, 20
 - location of, 25
 - stall, 25
- Used materials, 9

V

- Vacuum breakers (see Back-siphonage preventers)
- Valves
 - backwater, 27
 - check, 23, 27
 - direct flush, 16
 - drain, 42
 - gate, 27
 - pressure reducing, 46
 - pressure relief, 17, 43
 - shut-off, 27
 - temperature relief, 43
- Ventilation of rooms, 7
- Venting
 - of floor drains in basements, 35
 - of oil interceptors, 37
 - of sewage sumps, 37
 - stack, 36
 - systems, testing of, 22-23
 - wet, 36, 39
- Vents
 - branch, 39
 - circuit, 36, 39
 - continuous, 36
 - dual, 38
 - for traps, 35-36
 - relief, 36, 39
 - stack, 36, 41
 - yoke, 36-37, 39
- Vent pipes
 - arrangement of, 37-38
 - fixture connections to, 23-24
 - flashing for, 17
 - for soil-or-waste stacks, 36-37
 - location of, 37-38

- not required, 35-36
- sizing of, 39-41
- support of, above roof, 21
- terminals of, 38

Vent stacks, 36

- sizing of, 39, 41
- terminals of, 38
- where required, 36

Vertical piping, support of, 20

Vitreous china fixtures, 9

Vitrified clay pipe and fittings, 11-12,
21

W

Waste pipe, lead, 15, 21

Waste, treatment of, 25

Water closets, installation of, 16, 20

Water closet bowls, 10

- construction of, 10
- installation of, 20

Water closet seats, 7

Water hammer, prevention of, 43

Water heaters, storage type, 43

Water pipe

- asbestos-cement, 11

- size and capacity of, 45-46

Water supply, for fixtures, 45-46

Water systems (see Potable water systems,
Non-potable water systems)

- Water tests, 22, 23

Welded and seamless steel pipe, 13-14

Welded joints, 19

Welded sheet lead, 18-19

Wells, 45

Wet venting, 36, 39

Wiped joints, 17-18

Wiping solder, 16

Y

Y fitting (double or double combination), 10

Y and $\frac{1}{8}$ th bend fitting (single or double), 11

Yoke vent

- minimum diameter of, 39

- where required, 36-37