



CANADIAN COMMISSION ON  
BUILDING AND FIRE CODES



# PLUMBING

●●● National Plumbing Code of Canada 2020



National Research  
Council Canada

Conseil national de  
recherches Canada

Canada 

---

# **National Plumbing Code of Canada 2020**

**Issued by the  
Canadian Commission on Building and Fire Codes  
National Research Council of Canada**

First Edition 1970  
Second Edition 1975  
Third Edition 1977  
Fourth Edition 1980  
Fifth Edition 1985  
Sixth Edition 1990  
Seventh Edition 1995  
Eighth Edition 2005  
Ninth Edition 2010  
Tenth Edition 2015  
Eleventh Edition 2020

NRCC-CONST-56436E

© His Majesty the King in Right of Canada, as represented by  
the National Research Council of Canada, 2025

Paper: ISBN 978-0-660-37918-0 Cat. No. NR24-29/2020E  
PDF: ISBN 978-0-660-37916-6 Cat. No. NR24-29/2020E-PDF

Printed in Canada

Second Printing  
Includes Revisions and Errata released in February 2025.

Aussi disponible en français :

Code national de la plomberie – Canada 2020  
NRCC-CONST-56436F  
Papier : ISBN 978-0-660-37919-7  
PDF : ISBN 978-0-660-37917-3

---

# Table of Contents

## Preface

Relationship of the NPC to Standards Development and Conformity Assessment

Canadian Commission on Building and Fire Codes and Standing Committees

Revisions and Errata

## **Division A Compliance, Objectives and Functional Statements**

Part 1 Compliance

Part 2 Objectives

Part 3 Functional Statements

## **Division B Acceptable Solutions**

Part 1 General

Part 2 Plumbing Systems

## **Division C Administrative Provisions**

Part 1 General

Part 2 Administrative Provisions

## **Index**



# Preface

The National Plumbing Code of Canada 2020 (NPC), together with the National Building Code of Canada 2020 (NBC), the National Energy Code of Canada for Buildings 2020 (NECB) and the National Fire Code of Canada 2020 (NFC), was developed by the Canadian Commission on Building and Fire Codes (CCBFC) as an objective-based national model code that can be adopted by provincial and territorial governments.

In Canada, provincial and territorial governments have the authority to enact legislation that regulates the design and installation of plumbing systems within their jurisdictions. This may involve the adoption of the NPC without change or with modifications to suit local needs, and the enactment of other laws and regulations regarding plumbing system design and installation, including requirements for professional involvement.

The NPC is a model code in the sense that it helps promote consistency among provincial and territorial plumbing codes. Persons involved in the design or installation of plumbing systems should consult the provincial or territorial jurisdiction concerned to find out which plumbing code is applicable.

This edition of the NPC succeeds the 2015 edition.

## Development of the National Model Codes

**GOVERNANCE CHANGE NOTE:** The national code development system underwent a governance change in November 2022 to support efforts to harmonize construction codes in jurisdictions throughout Canada. The CCBFC, which had been in place since 1991, was dissolved and replaced by a new governance model in which the Canadian Board for Harmonized Construction Codes (CBHCC) is responsible for developing, approving and maintaining the National Model Codes based on the strategic priorities set by the Canadian Table for Harmonized Construction Codes Policy. The 2020 National Model Codes were developed by the CCBFC. In this section, references to the CCBFC are written in the past tense to reflect the change in governance.

The CCBFC, an independent committee established by the National Research Council of Canada (NRC), was responsible for the content of the 2020 editions of the National Model Codes. The CCBFC was made up of volunteers from across the country and from all facets of the Codes-user community. Members of the CCBFC and its standing committees included builders, engineers, skilled trade workers, architects, building owners, building operators, fire and building officials, manufacturers, and representatives of general interests.

The CCBFC was advised on scope, policy and technical issues pertaining to the Codes by the Provincial/Territorial Policy Advisory Committee on Codes (PTPACC), which was a committee of senior representatives from provincial/territorial ministries responsible for building, fire, plumbing, and energy regulation in their jurisdictions. The PTPACC was created by the provinces and territories, with provision of guidance to the CCBFC as one of its main functions. Through the PTPACC, the provinces and territories were engaged in every phase of the Codes development process.

Codes Canada staff within the Construction Research Centre at the NRC provided technical and administrative support to the CCBFC and its standing committees, and coordinated the provision of evidence-based research to inform Codes development. The NRC publishes the National Model Codes and periodic revisions to the Codes to address pressing issues.

The broader Codes-user community makes significant contributions to the Codes development process by submitting requests for changes or additions to the Codes and by commenting on the proposed changes during the public reviews that precede each new edition.

The CCBFC took into consideration the advice received from the provinces and territories as well as Codes users' comments at each stage of Codes development. The scope and content of the National Model Codes are determined on a consensus basis, which involves the review of technical, policy and practical concerns and discussion of the implications of these concerns.

More information on the Codes development process is available on the CBHCC's website.

## **National Plumbing Code of Canada 2020**

The NPC sets out technical provisions for the design and installation of new plumbing systems. It also applies to the extension, alteration, renewal and repair of existing plumbing systems.

The NPC establishes requirements to address the following four objectives:

- safety
- health
- protection of the building or facility from water and sewage damage
- environment

Code provisions do not necessarily address all the characteristics of buildings and facilities that might be considered to have a bearing on the Code's objectives. Through the extensive consensus process used to develop and maintain the National Model Codes (see the section entitled Development of the National Model Codes), the Codes-user community has decided which characteristics should be regulated through the NPC.

The provisions of the NPC can be considered as the minimum acceptable measures required to adequately achieve the above-listed objectives, as recommended by the CCBFC. Once they are adopted into law or regulation by an authority having jurisdiction, the provisions become minimum acceptable requirements representing the minimum level of performance required to achieve the objectives that is acceptable to the adopting authority.

The NPC is a model code which, when adopted or adapted by a province or territory, becomes a regulation. It is not a guideline on plumbing system design or installation. The design of a technically sound plumbing system depends upon many factors beyond compliance with plumbing regulations. Such factors include the availability of knowledgeable practitioners who have received appropriate education, training and experience and who are familiar with the principles of good plumbing practice and experience using reference manuals and technical guides.

The NPC does not list acceptable proprietary plumbing products. It establishes the criteria that plumbing materials, products and assemblies must meet. Some of these criteria are explicitly stated in the NPC while others are incorporated by reference to material or product standards published by standards development organizations. Only those portions of the standards related to the objectives of this Code are mandatory parts of the NPC.

### **Code Requirements**

Most NPC requirements address at least one of the Code's four stated objectives (safety, health, protection of the building or facility from water and sewage damage, and environment).

In processing proposed changes or additions to any of the National Model Codes, many issues are considered, such as the following:

- Does the proposed requirement provide the minimum level of performance—and no more than the minimum—needed to achieve the Code's objectives?

- Will persons responsible for Code compliance be able to act on or implement the requirement using commonly accepted practices?
- Will enforcement agencies be able to enforce the requirement?
- Are the costs of implementing the requirement justifiable?
- Have the potential policy implications of the requirement been identified and addressed?
- Is there broad consensus on this requirement among Code users representing all facets of the plumbing system design and construction industries, as well as among provincial and territorial governments?

Guidelines for requesting changes to the NPC are available on the CBHCC's website.

## Objective-Based Code Format

The NPC has been published in an objective-based code format since 2005.

As described in more detail in the section entitled Structure of the NPC, the Code comprises three Divisions:

- Division A, which defines the scope of the Code and contains the objectives, the functional statements and the conditions necessary to achieve compliance;
- Division B, which contains acceptable solutions (commonly referred to as “technical requirements”) deemed to satisfy the objectives and functional statements listed in Division A; and
- Division C, which contains administrative provisions.

Most of the requirements in Division B are linked to three types of information:

- objectives (Code objectives, such as safety or health, which individual requirements help to address),
- functional statements (statements of the functions of the plumbing system that a particular requirement helps to achieve), and
- intent statements (detailed statements of the specific intent of the requirement).

### Objectives

The NPC's objectives are fully defined in Section 2.2. of Division A.

The objectives describe, in broad terms, the overall goals that the NPC's requirements are intended to achieve. They serve to define the boundaries of the subject areas the Code addresses. However, the Code does not address all the issues that might be considered to fall within those boundaries.

The objectives describe undesirable situations and their consequences, which the Code aims to prevent from occurring in plumbing systems. The wording of most of the definitions of the objectives includes two key phrases: “limit the probability” and “unacceptable risk.” The phrase “limit the probability” is used to acknowledge that the NPC cannot entirely prevent those undesirable situations from happening. The phrase “unacceptable risk” acknowledges that the NPC cannot eliminate all risk: the “acceptable risk” is the risk remaining once compliance with the Code has been achieved.

The objectives are entirely qualitative and are not intended to be used on their own in the design and approval processes.

The objectives attributed to the requirements or portions of requirements in Division B are listed in a table in Section 2.8. of Division B.

### Functional Statements

The NPC's functional statements are defined in Section 3.2. of Division A.

The functional statements are more detailed than the objectives. They describe conditions in the plumbing system that help satisfy the objectives. The functional statements and the



objectives are interconnected. There may be several functional statements related to any one objective, and a given functional statement may describe a function of the plumbing system that serves to achieve more than one objective.

Like objectives, functional statements are entirely qualitative and are not intended to be used on their own in the design and approval processes.

The functional statements attributed to the requirements or portions of requirements in Division B are listed in a table in Section 2.8. of Division B.

## Intent Statements

Intent statements explain the basic thinking behind each Code provision contained in Division B. Intent statements, each of which is unique to the provision with which it is associated, explain how requirements help to achieve their attributed objectives and functional statements. Like the objectives, the intent statements are expressed in terms of risk avoidance and expected performance. They offer insight into the views of the responsible standing committee on what the Code provisions are intended to achieve.

The intent statements serve explanatory purposes only and do not form an integral part of the Code provisions. As such, they are similar in function to the explanatory Notes at the end of each Part. Due to the sheer volume of intent statements—hundreds for the NPC alone—they are made available as a separate electronic document entitled “Supplement to the NPC 2020: Intent Statements,” which is posted on the NRC's website.

All this additional information—objectives, functional statements and intent statements—is intended to facilitate the implementation of the Code in two ways:

- **Clarity of intent:** The objectives, functional statements and intent statements linked to a Code requirement clarify the reasoning behind that requirement and facilitate understanding of what must be done to satisfy that requirement. This added information may also help avoid disputes between practitioners and officials over these types of issues.
- **Flexibility:** The additional information allows for flexibility in Code compliance. A person seeking to propose a new method or material not described or covered in the Code will be able to use the added information to understand the expected level of performance that their alternative solution must achieve to satisfy the Code.

## Structure of the NPC

The NPC is organized into three Divisions.

### Division A: Compliance, Objectives and Functional Statements

Division A defines the scope of the NPC and presents the objectives that the Code addresses and the functions the plumbing system must perform to help to satisfy those objectives.

Division A cannot be used on its own as a basis for designing and installing a plumbing system or for evaluating a plumbing system's compliance with the Code.

### Division B: Acceptable Solutions

The term “acceptable solutions” refers to the technical requirements contained in the Code. It reflects the principle that plumbing codes establish an acceptable level of risk or performance and underlines the fact that a code cannot describe all possible valid design and installation options. Acceptable solutions represent the minimum level of performance that will satisfy the NPC's objectives and that is acceptable to an authority that adopts the NPC into law or regulation.

Most of the requirements in Division B—the acceptable solutions—are linked to at least one objective and functional statement found in Division A. These linkages play an important role in allowing objective-based codes to accommodate innovation.

It is expected that the majority of Code users will primarily follow the acceptable solutions presented in Division B and that they will consult Division A only when seeking clarification on the application of Division B's requirements to a particular situation, when considering an alternative solution, or when looking up the definition of selected terms in the context of the NPC.

## Division C: Administrative Provisions

Division C contains administrative provisions relating to the application of the Code. Many provinces and territories establish their own administrative provisions upon adopting or adapting the NPC; having all the administrative provisions in one Division facilitates their customization to suit jurisdictional needs.

In addition, a separate document entitled Administrative Requirements for Use with the National Building Code of Canada 1985 is automatically adopted, in accordance with Article 2.2.1.1. of Division C, if the authority having jurisdiction does not provide other administrative requirements.

## Relationship between Division A and Division B

Sentence 1.2.1.1.(1) of Division A is a very important sentence: it is a precise statement of the relationship between Divisions A and B and is central to the concept of objective-based codes.

- 1)** Compliance with this Code shall be achieved by
  - a) complying with the applicable acceptable solutions in Division B (see Note A-1.2.1.1.(1)(a)), or
  - b) using alternative solutions that will achieve at least the minimum level of performance required by Division B in the areas defined by the objectives and functional statements attributed to the applicable acceptable solutions (see Note A-1.2.1.1.(1)(b)).

Clause (a) makes it clear that the acceptable solutions in Division B are automatically deemed to satisfy the linked objectives and functional statements of Division A.

Clause (b) makes it clear that alternative solutions can be used in lieu of compliance with the acceptable solutions. However, to do something different from the acceptable solutions described in Division B, a proponent must show that their proposed alternative solution will perform at least as well as the acceptable solution(s) it is replacing. The objectives and functional statements attributed to the acceptable solution(s) identify the areas of performance where this equivalence must be demonstrated.

## Additional Information

### Numbering System

A consistent numbering system has been used throughout the National Model Codes. The first number indicates the Part of the Code; the second, the Section in the Part; the third, the Subsection; and the fourth, the Article in the Subsection. The detailed provisions are found at the Sentence level (indicated by numbers in brackets), and Sentences may be broken down into Clauses and Subclauses. This structure is illustrated as follows:

3	Part
3.5.	Section
3.5.2.	Subsection
3.5.2.1.	Article
3.5.2.1.(2)	Sentence
3.5.2.1.(2)(a)	Clause
3.5.2.1.(2)(a)(i)	Subclause

## Meaning of the Words “And” and “Or” between the Clauses and Subclauses of a Sentence

Multiple Clauses and Subclauses are connected by the word “and” or “or” at the end of the second last Clause or Subclause in the series. Although this connecting word appears only once, it is meant to apply to all the preceding Clauses or Subclauses within that series.

For example, in a series of five Clauses—(a) to (e)—in a Sentence, the appearance of the word “and” at the end of Clause (d) means that all Clauses in the Sentence are connected to each other with the word “and.” Similarly, in a series of five Clauses—(a) to (e)—in a Sentence, the appearance of the word “or” at the end of Clause (d) means that all Clauses in the Sentence are connected to each other with the word “or.”

In all cases, it is important to note that a Clause (and its Subclauses, if any) must always be read in conjunction with its introductory text appearing at the beginning of the Sentence. Moreover, the connecting words “and” and “or” must be read in the context of the Sentence. In particular, the use of the word “and” as a connecting word does not necessarily mean that all Clauses (or Subclauses) are applicable for compliance with the Sentence.

## Change Indication

As a courtesy to Code users, efforts have been made to identify technical changes relative to the 2015 edition. Where a technical addition or revision has been made, a vertical line has been added in the margin next to the affected provision to indicate the approximate location of the new or revised content. No change indication is provided for editorial revisions or for renumbered or deleted content.

## Units

All values in the NPC, other than nominal pipe sizes, are given in metric units. Some of the metric values in the Code have been converted and rounded from imperial values. A conversion table of imperial equivalents for the most common units used in plumbing system design and installation is located at the end of the Code.

## Complementary Publications

The following publications are referenced in the NPC 2020 or facilitate the application of its requirements:

- National Building Code of Canada 2020
- Supplement to the NPC 2020: Intent Statements

These and other Code documents published by the NRC are made available in free electronic format on the NRC’s website.

---

## **Commercial Reproduction**

Copyright for the NPC is owned by the NRC. All rights are reserved. Commercial reproduction by any means of the NRC's copyright material is prohibited without the written consent of the NRC. To request permission to reproduce the NPC, please contact:

Production and Marketing Manager  
Codes Canada  
National Research Council of Canada  
1200 Montreal Road  
Ottawa, Ontario K1A 0R6  
E-mail: Codes@nrc-cnrc.gc.ca

## **Contact Information**

The CBHCC welcomes comments and suggestions for improvements to the NPC. Persons interested in requesting a change to an NPC provision should refer to the guidelines available on the CHBCC's website.

To submit comments or suggestions, please contact:

The Secretary  
Canadian Board for Harmonized Construction Codes  
1200 Montreal Road  
Ottawa, Ontario K1A 0R6  
E-mail: CBHCCSecretary-SecretaireCCHCC@nrc-cnrc.gc.ca



# Relationship of the NPC to Standards Development and Conformity Assessment

The development of many provisions in the NPC and the assessment of conformity to those provisions are supported by several of the member organizations of Canada's National Standards System (NSS).

The NSS is a network of accredited organizations concerned with standards development, certification, testing and inspection that is established under the auspices of the Standards Council of Canada Act. Activities of the NSS are coordinated by the Standards Council of Canada (SCC), which accredits standards development organizations, certification bodies, testing and calibration laboratories, and inspection bodies, among others.

The SCC is a non-profit federal Crown corporation responsible for the coordination of voluntary standardization in Canada. It also coordinates Canadian participation in voluntary international standardization activities.

## Canadian Standards

Many of the standards referenced in the NPC are published by standards development organizations accredited in Canada. As part of the accreditation requirements, these organizations adhere to the principle of consensus, which generally means substantial majority agreement of a committee comprising a balance of producer, user and general interest members, and the consideration of all negative comments. The standards development organizations also have formal procedures for the balloting and second-level review of standards prepared under their oversight.

The following organizations are accredited as standards development organizations in Canada:

- Air-Conditioning, Heating and Refrigeration Institute (AHRI)
- ASTM International
- Bureau de normalisation du Québec (BNQ)
- Canadian General Standards Board (CGSB)
- CSA Group
- International Association of Plumbing and Mechanical Officials (IAPMO)
- ULC Standards
- Underwriters' Laboratories Inc. (UL)

Table 1.3.1.2. of Division B lists the standards referenced in the NPC. Standards proposed to be referenced in the NPC are reviewed to ensure that their content is compatible with the Code. Thereafter, referenced standards are reviewed as needed during each Code cycle. Standards development organizations are asked to provide information on any changes in the status of their standards referenced in the NPC—withdrawals, amendments, new editions, etc. This information is passed on to the CBHCC, its code development committees, and interested stakeholders, all of whom are given the opportunity to identify any problems associated with the changes. These bodies do not necessarily review in detail the revised standards; rather, the approach relies on the consensus process involved in the maintenance of the standards and on the extensive knowledge and experience of committee members, provincial or territorial staff, NRC staff, and consulted stakeholders to identify changes in the standards that might create problems in the Code.

## Non-Canadian Standards

A number of subject areas for which the standards development organizations accredited in Canada have not developed standards are covered in the NPC. In these cases, the Code often references standards developed by organizations in other countries, such as the American Society of Heating, Refrigerating and Air-Conditioning Engineers (ASHRAE) and the National Fire Protection Association (NFPA). These standards are developed using processes that may differ from those used by the standards development organizations accredited in Canada; nevertheless, the standards have been reviewed by the relevant standing committees and found to be acceptable.

## Conformity Assessment

The NPC establishes minimum measures, which are set out within its own text or within referenced standards. However, the NPC does not set out who is responsible for assessing conformity to the measures or how those with this responsibility might carry it out. This responsibility is usually established by the governing legislation of the adopting provinces and territories. Provincial or territorial authorities should be consulted to determine who is responsible for conformity assessment within their jurisdiction.

Those persons responsible for ensuring that materials, appliances, systems and equipment meet the requirements of this Code have several means available to assist them, ranging from on-site inspection to the use of certification services provided by accredited third-party organizations. Test reports or mill certificates provided by manufacturers or suppliers can also assist in the acceptance of products. Engineering reports may be required for more complex products.

### Testing

The SCC accredits testing and calibration laboratories that are capable of reliably testing products to specified standards. The test results produced by these organizations can be used in the certification, evaluation and qualification of products for compliance with Code provisions. The SCC's website ([www.scc.ca](http://www.scc.ca)) lists accredited testing and calibration laboratories, along with their scope of accreditation.

### Certification

Certification is the confirmation by an independent organization that a product, process, service or system meets a requirement. Certification may entail physical examination, testing as specified in appropriate standards, an initial plant inspection, and/or follow-up unannounced plant inspections. This procedure leads to the issuing of a formal assurance or declaration, by means of a certification mark or certificate, that the product, process, service or system is in full conformity with specified provisions.

In some cases, a product for which no standard exists can be certified using procedures and criteria developed by an accredited certification body and specifically designed to measure the performance of that product.

Certification bodies publish lists of certified products and companies. The SCC's website ([www.scc.ca](http://www.scc.ca)) lists accredited certification bodies, along with their scope of accreditation. Several organizations, including the Canadian Construction Materials Centre (CCMC) at the NRC, offer product certification services.

### Evaluation

An evaluation is a written opinion by an independent professional organization that a product will perform its intended function. An evaluation is often done to determine the ability of an innovative product, for which no standards exist, to satisfy the intent of a Code requirement. Follow-up plant inspections are not normally part of the evaluation process.

---

## Qualification

Qualification evaluates the ability of a product to perform its intended function by verifying that it meets the requirements of a standard. Qualification normally includes some follow-up plant inspection. Some organizations publish lists of qualified products that meet the specified requirements. Some organizations qualify product manufacturing and/or testing facilities for compliance with the Code and relevant standards.





# Canadian Commission on Building and Fire Codes and Standing Committees

## Canadian Commission on Building and Fire Codes

D. Crawford ( <i>Chair</i> )	C. Gray	T. Ross	Codes Canada staff
R. Arsenault	H. Griffin	R. Rymell	who provided assistance
K. Block	K. Griffiths	B. Sim	to the Commission
A. Borooah	T. Harper	S. Stinson	M. Dumoulin
R. Brooks	L. Holmen	D. Sullivan	G. Gosselin
J. Chauvin	C. Joseph <sup>(1)</sup>	A. Tabet	A. Gribbon
M. Cianchetti	K. Lee	P. Thorkelsson	P. Jago
T. Cochren	B. Lorne	M. Tovey	A. Laroche
V. de Passillé	D. MacKinnon	C. Tye	F. Lohmann
R. Dulmage	M. McSweeney	E. Whalen	P. Rizcallah
C. Fillingham	G. Morinville	G. Yoshida	R. Tremblay
S. Garcia	S. Ottens		
K. Gloge	R. Richard		

## Standing Committee on HVAC and Plumbing

T. White ( <i>Chair</i> )	R. Roberts
H. Bouchard	C. Roy
F. Di Folco	A. Spurrell
Y. Duchesne	G. Stasyneq
L. Gill	S. Steele
R. Gill	K. Wong
X. Hao	
E. Howard	Codes Canada staff
D. Hui	who provided assistance
D. Lima	to the Committee
S. Manning	T. Achour
R. Moulton	D. Green
E. Piecuch	P. Tardif
T. Pringle	

## Technical Translation Verification Committee

G. Harvey ( <i>Chair</i> )	Codes Canada staff
F. Genest	who provided assistance
B. Lagueux	to the Committee
N. Lessard	I. Bastien
I. Wagner	M. Gingras
	K. Le Van
	G. Mougeot-Lemay
	S. Veilleux

<sup>(1)</sup> Resigned on September 23, 2016, due to employment opportunity with Codes Canada.



# Revisions and Errata

## Issued by the Canadian Board for Harmonized Construction Codes

The Change Summary table that follows describes revisions, errata and editorial modifications that apply to the National Plumbing Code of Canada 2020:

- Revisions are changes that have been approved by the Canadian Board for Harmonized Construction Codes for publication between Code editions.
- Errata are corrections to existing text.
- Editorial updates are provided for information purposes only.
- Editorial changes are modifications that improve clarity.

Code pages containing revisions and/or errata are identified with the words “Amended Page” in the footer; pages with editorial modifications and index pages with changes are not flagged.

Code users should contact their local authority having jurisdiction to find out if these revisions and errata apply in their province or territory.

### Change Summary (Date: 2025-02) — National Plumbing Code of Canada 2020

Division	Code Reference	Change	Description of Change
Preface	n/a	editorial update	Preface was updated to reflect change in governance of national code development system
A	1.4.1.2.(1)	errata (unless otherwise indicated)  editorial change	List of defined terms was corrected as follows: <i>Care*</i> : term and definition were added <i>Care occupancy*</i> : term and definition were added <i>Care or detention occupancy</i> : term and definition were deleted <i>Detention occupancy*</i> : term and definition were added <i>Home-type care occupancy*</i> : term and definition were added <i>Nominal pipe size (NPS)</i> : definition was revised to read “... nominal diameter in inches by which the size of a pipe, ...” <i>Treatment*</i> : term and definition were added <i>Treatment occupancy*</i> : term and definition were added
	A-1.4.1.2.(1)	errata	Note was corrected as follows: Section titled “Care Occupancy” was added Section titled “Home-Type Care Occupancy” was added Section titled “Treatment” was added Section titled “Treatment Occupancy” was added

### Change Summary (Date: 2025-02) — National Plumbing Code of Canada 2020 (Continued)

Division	Code Reference	Change	Description of Change
B	1.3.1.1.(1)	revision	Date stated in Sentence was revised to read "15 July 2022"
	Table 1.3.1.2.	revision	Document references were updated as applicable to reflect more recent editions published as of 15 July 2022
	1.3.2.1.	editorial update	List of abbreviations was updated to include "CBHCC"
	2.4.4.3.(1)	erratum	Sentence was corrected to read "... or in a <i>care, treatment or detention occupancy, ...</i> "
	2.4.6.4.	errata	Article was corrected as follows: Sentences were reordered and revised for clarity Sentence (2) was added Sentence (3) was corrected to read "Except as provided in Sentences (4) and (5), ..."
	Table 2.8.1.1.	erratum	Article 2.4.6.4.: entry was added as follows: "(2) [F81-OH2.1]"
	Figure A-2.5.3.1.-E	erratum	Figure was corrected by moving "This stack may act as the relief vent ..." from Example 2 to Example 1
C	A-2.3.1.	editorial update	Last paragraph of Note was updated to read "... on the CBHCC's website."
Index	Letter C	erratum	"Care or detention occupancy" was corrected to read "Care, treatment or detention occupancy"
	Letter D	erratum	"Detention occupancy": entry was added
	Letter H	erratum	"Home-type care occupancy": entry was added
	Letter T	erratum	"Treatment occupancy": entry was added

---

## **Division A**

# **Compliance, Objectives and Functional Statements**



---

## **Division A**

# **Part 1 Compliance**

<b>1.1.</b>	<b>General</b>	
1.1.1.	Application of this Code .....	1-1
<b>1.2.</b>	<b>Compliance</b>	
1.2.1.	Compliance with this Code .....	1-1
1.2.2.	Materials, Systems and Equipment .....	1-1
<b>1.3.</b>	<b>Divisions A, B and C of this Code</b>	
1.3.1.	General .....	1-2
1.3.2.	Application of Division A .....	1-2
1.3.3.	Application of Division B .....	1-2
1.3.4.	Application of Division C .....	1-2
<b>1.4.</b>	<b>Terms and Abbreviations</b>	
1.4.1.	Definitions of Words and Phrases ..	1-2
1.4.2.	Symbols and Other Abbreviations ..	1-8
<b>1.5.</b>	<b>Referenced Documents and Organizations</b>	
1.5.1.	Referenced Documents .....	1-9
1.5.2.	Organizations .....	1-9
	<b>Notes to Part 1 .....</b>	<b>1-11</b>





## Division A

# Part 1 Compliance

## Section 1.1. General

### 1.1.1. Application of this Code

#### 1.1.1.1. Application of this Code

- 1) This Code applies to the design, installation, extension, alteration, renewal or repair of *plumbing systems*.
- 2) This Code specifies the minimum requirements for
  - a) *drainage systems* for water-borne wastes and *storm water* for *buildings* to the point of connection with public services,
  - b) *venting systems*,
  - c) *water service pipes*, and
  - d) *water distribution systems*.
- 3) Plumbing facilities in *buildings* shall be provided in accordance with Part 7 of Division B of the National Building Code of Canada 2020.

## Section 1.2. Compliance

### 1.2.1. Compliance with this Code

#### 1.2.1.1. Compliance with this Code

- 1) Compliance with this Code shall be achieved by
  - a) complying with the applicable acceptable solutions in Division B (see Note A-1.2.1.1.(1)(a)), or
  - b) using alternative solutions that will achieve at least the minimum level of performance required by Division B in the areas defined by the objectives and functional statements attributed to the applicable acceptable solutions (see Note A-1.2.1.1.(1)(b)).
- 2) For the purposes of compliance with this Code as required in Clause 1.2.1.1.(1)(b), the objectives and functional statements attributed to the acceptable solutions in Division B shall be the objectives and functional statements referred to in Subsection 1.1.2. of Division B.

### 1.2.2. Materials, Systems and Equipment

#### 1.2.2.1. Characteristics of Materials, Systems and Equipment

- 1) All materials, systems and equipment installed to meet the requirements of this Code shall be free of defects and possess the necessary characteristics to perform their intended functions when installed.

**1.2.2.2.****1.2.2.2. Used Materials and Equipment**

1) Used materials and equipment, including *fixtures*, shall not be reused unless they meet the requirements of this Code for new materials and equipment and are otherwise satisfactory for their intended use.

**Section 1.3. Divisions A, B and C of this Code****1.3.1. General****1.3.1.1. Scope of Division A**

1) Division A contains the compliance and application provisions, objectives and functional statements of this Code.

**1.3.1.2. Scope of Division B**

1) Division B contains the acceptable solutions of this Code.

**1.3.1.3. Scope of Division C**

1) Division C contains the administrative provisions of this Code.

**1.3.1.4. Internal Cross-references**

1) Where the Division of a referenced provision is not specified in this Code, it shall mean that the referenced provision is in the same Division as the referencing provision.

**1.3.2. Application of Division A****1.3.2.1. Application of Parts 1, 2 and 3**

1) Parts 1, 2 and 3 of Division A apply to all *plumbing systems* covered in this Code. (See Article 1.1.1.1.)

**1.3.3. Application of Division B****1.3.3.1. Application of Parts 1 and 2**

1) Parts 1 and 2 of Division B apply to all *plumbing systems* covered in this Code. (See Article 1.1.1.1.)

**1.3.4. Application of Division C****1.3.4.1. Application of Parts 1 and 2**

1) Parts 1 and 2 of Division C apply to all *plumbing systems* covered in this Code. (See Article 1.1.1.1.)

**Section 1.4. Terms and Abbreviations****1.4.1. Definitions of Words and Phrases****1.4.1.1. Non-defined Terms**

1) Words and phrases used in this Code that are not included in the list of definitions in Article 1.4.1.2. shall have the meanings that are commonly assigned to them in the context in which they are used, taking into account the specialized use of terms by the various trades and professions to which the terminology applies.

2) Where objectives and functional statements are referred to in this Code, they shall be the objectives and functional statements described in Parts 2 and 3.

**3)** Where acceptable solutions are referred to in this Code, they shall be the provisions stated in Part 2 of Division B.

**4)** Where alternative solutions are referred to in this Code, they shall be the alternative solutions mentioned in Clause 1.2.1.1.(1)(b).

### 1.4.1.2. Defined Terms

**1)** The words and terms in italics in this Code shall have the following meanings (an asterisk (\*) following a defined word or term indicates that the definition for that word or term is taken from the NBC):

*Additional circuit vent* means a *vent pipe* that is installed between a *circuit vent* and a *relief vent* to provide additional air circulation.

*Air admittance valve* means a one-way valve designed to allow air to enter the *drainage system* when the pressure in the *plumbing system* is less than the atmospheric pressure. (See Note A-2.2.10.16.(1) of Division B.)

*Air break* means the unobstructed vertical distance between the lowest point of an *indirectly connected sanitary drainage pipe* and the *flood level rim* of the *fixture* into which it discharges. (See Note A-2.3.3.11.(2) of Division B.)

*Air gap* means the unobstructed vertical distance through air between the lowest point of a water supply outlet and the *flood level rim* of the *fixture* or device into which the outlet discharges. (See Note A-2.6.2.9.(2) of Division B.)

*Alloyed zinc* means an alloy of zinc having the corrosion resistance and physical properties of an alloy containing 0.15% titanium, 0.74% copper and 99.11% zinc, and so tempered as to be capable of being formed into the shape required for a watertight joint.

*Auxiliary water supply* means any water supply on or available to the premises other than the primary *potable* water supply. (See Note A-1.4.1.2.(1).)

*Backflow* means a flowing back or reversal of the normal direction of the flow.

*Backflow preventer* means a device or a method that prevents *backflow*. (See Figure A-1.4.1.2.(1)-A in Note A-1.4.1.2.(1).)

*Back pressure* means pressure higher than the supply pressure.

*Back-siphonage* means *backflow* caused by a negative pressure in the supply system. (See Figure A-1.4.1.2.(1)-B in Note A-1.4.1.2.(1).)

*Back-siphonage preventer* (or *vacuum breaker*) means a device or a method that prevents *back-siphonage*. (See Figure A-1.4.1.2.(1)-C in Note A-1.4.1.2.(1).)

*Backwater valve* means a *check valve* designed for use in a gravity *drainage system*.

*Bathroom group* means a group of plumbing *fixtures* installed in the same room, consisting of one domestic-type lavatory, one water closet and either one bathtub (with or without a shower) or one one-head shower.

*Branch* means a *sanitary drainage pipe* connected at its upstream end to the junction of 2 or more *sanitary drainage pipes* or to a *stack*, and connected at its downstream end to another *branch*, a sump, a *stack* or a *building drain*. (See Figure A-1.4.1.2.(1)-F in Note A-1.4.1.2.(1).)

*Branch vent* means a *vent pipe* that is connected at its lower end to the junction of 2 or more *vent pipes*, and at its upper end, either to another *branch vent* or to a *stack vent*, *vent stack* or *vent header*, or terminates in open air. (See Figure A-1.4.1.2.(1)-D in Note A-1.4.1.2.(1).)

*Building\** means any structure used or intended for supporting or sheltering any use or *occupancy*.

*Building drain* means the lowest horizontal piping, including any vertical *offset*, that conducts *sewage*, *clear-water waste* or *storm water* by gravity to a *building sewer*. (See Figure A-1.4.1.2.(1)-F in Note A-1.4.1.2.(1).)

*Building sewer* means a pipe that is connected to a *building drain* 1 m outside a wall of a *building* and that leads to a public sewer or *private sewage disposal system*.

- Building trap* means a *trap* that is installed in a *building drain* or *building sewer* to prevent the circulation of air between a *drainage system* and a public sewer. (See Note A-2.4.5.4.(1) of Division B.)
- Care\** means the provision of services other than *treatment* by or through care facility management to residents who require these services because of cognitive, physical or behavioural limitations.
- Care occupancy\** (Group B, Division 3) means the *occupancy* or use of a *building* or part thereof, other than a *home-type care occupancy*, where *care* is provided to residents. (See Note A-1.4.1.2.(1).)
- Check valve* means a valve that permits flow in one direction but prevents a return flow.
- Circuit vent* means a *vent pipe* that serves a number of *fixtures* and connects to the *fixture drain* of the most upstream *fixture*.
- Class 1 fire sprinkler/standpipe system* means an assembly of pipes and fittings that conveys water from the *water service pipe* to the sprinkler/standpipe system's outlets, is *directly connected* to the public water supply main only, has no pumps or reservoirs, and in which the sprinkler drains discharge to the atmosphere, to dry wells or to other safe outlets.
- Class 2 fire sprinkler/standpipe system* means a *Class 1 fire sprinkler/standpipe system* that includes a booster pump in its connection to the public water supply main.
- Class 3 fire sprinkler/standpipe system* means an assembly of pipes and fittings that conveys water from the *water service pipe* to the sprinkler/standpipe system's outlets and is *directly connected* to the public water supply main as well as to one or more of the following storage facilities, which are filled from the public water supply main only: elevated water storage, fire pumps supplying water from aboveground covered reservoirs, or pressure tanks. The water in this sprinkler/standpipe system must be maintained in *potable* condition. (See Note A-1.4.1.2.(1).)
- Class 4 fire sprinkler/standpipe system* means an assembly of pipes and fittings that conveys water from the *water service pipe* to the sprinkler/standpipe system's outlets and is *directly connected* to the public water supply main (similar to *Class 1* and *Class 2 fire sprinkler/standpipe systems*) and to an *auxiliary water supply* dedicated to fire department use that is located within 520 m of a pumper connection.
- Class 5 fire sprinkler/standpipe system* means an assembly of pipes and fittings that conveys water from the *water service pipe* to the sprinkler/standpipe system's outlets and is *directly connected* to the public water supply main and also interconnected with an *auxiliary water supply*.
- Class 6 fire sprinkler/standpipe system* means an assembly of pipes and fittings that conveys water from the *water service pipe* to the sprinkler/standpipe system's outlets and acts as a combined industrial water supply and fire protection system supplied from the public water supply main only, with or without gravity storage or pump suction tanks.
- Cleanout* means an access provided in *drainage* and *venting systems* to provide for cleaning and inspection services.
- Clear-water waste* means waste water with impurity levels that will not be harmful to health and may include cooling water and condensate drainage from refrigeration and air-conditioning equipment and cooled condensate from steam heating systems, but does not include *storm water*. (See Note A-1.4.1.2.(1).)
- Combined building drain* means a *building drain* that is intended to conduct *sewage* and *storm water*.
- Combined building sewer* means a *building sewer* that is intended to conduct *sewage* and *storm water*.
- Combined sewer* means a sewer that is intended to conduct *sewage* and *storm water*.
- Combustible\** means that a material fails to meet the acceptance criteria of CAN/ULC-S114, "Standard Method of Test for Determination of Non-Combustibility in Building Materials."

*Continuous vent* means a *vent pipe* that is an extension of a vertical section of a *branch* or *fixture drain*. (See Figure A-1.4.1.2.(1)-E in Note A-1.4.1.2.(1).)

*Critical level* means the level of submergence at which the *back-siphonage preventer* ceases to prevent *back-siphonage*.

*Dead end* means a pipe that terminates with a closed fitting.

*Detention occupancy\** (Group B, Division 1) means the *occupancy* by persons who are restrained from or are incapable of evacuating to a safe location without the assistance of another person because of security measures not under their control.

*Developed length* means the length along the centre line of the pipe and fittings. (See Note A-2.5.6.3.(1) of Division B.)

*Directly connected* means physically connected in such a way that water or gas cannot escape from the connection.

*Drainage system* means an assembly of pipes, fittings, *fixtures*, *traps* and appurtenances that is used to convey *sewage*, *clear-water waste* or *storm water* to a public sewer or a *private sewage disposal system*, but does not include *subsoil drainage pipes*. (See Figure A-1.4.1.2.(1)-F in Note A-1.4.1.2.(1).)

*Dual vent* means a *vent pipe* that serves 2 *fixtures* and connects at the junction of the *trap arms*. (See Figure A-1.4.1.2.(1)-G in Note A-1.4.1.2.(1).)

*Dwelling unit\** means a *suite* operated as a housekeeping unit, used or intended to be used by one or more persons and usually containing cooking, eating, living, sleeping and sanitary facilities.

*Emergency floor drain* means a *fixture* for the purposes of overflow protection that does not receive regular discharge from other *fixtures*, other than from a *trap primer*. (See Note A-1.4.1.2.(1).)

*Fire separation\** means a construction assembly that acts as a barrier against the spread of fire.

*Fire service pipe* means a pipe that conveys water from a public water main or private water source to the inside of a *building* for the purpose of supplying the fire sprinkler or standpipe systems.

*Fixture* means a receptacle, appliance, apparatus or other device that discharges *sewage* or *clear-water waste*, and includes a floor drain.

*Fixture drain* means the pipe that connects a *trap* serving a *fixture* to another part of a *drainage system*.

*Fixture outlet pipe* means a pipe that connects the waste opening of a *fixture* to the *trap* serving the *fixture*. (See Figure A-1.4.1.2.(1)-H in Note A-1.4.1.2.(1).)

*Fixture unit* (as applying to *drainage systems*) means the unit of measure based on the rate of discharge, time of operation and frequency of use of a *fixture* that expresses the hydraulic load that is imposed by that *fixture* on the *drainage system*.

*Fixture unit* (as applying to *water distribution systems*) means the unit of measure based on the rate of supply, time of operation and frequency of use of a *fixture* or outlet that expresses the hydraulic load that is imposed by that *fixture* or outlet on the supply system.

*Flood level rim* means the top edge at which water can overflow from a *fixture* or device. (See Figure A-1.4.1.2.(1)-B in Note A-1.4.1.2.(1).)

*Flow control roof drain* means a *roof drain* that restricts the flow of *storm water* into the *storm drainage system*.

*Fresh air inlet* means a *vent pipe* that is installed in conjunction with a *building trap* and terminates outdoors. (See Note A-2.4.5.4.(1) of Division B.)

*Home-type care occupancy\** (Group B, Division 4) means the *occupancy* or use of a *building* consisting of a single detached housekeeping unit where *care* is provided to residents and may include the living space of the caregiver and their family. (See Note A-1.4.1.2.(1).)

*Indirectly connected* means not *directly connected*. (See Note A-2.3.3.11.(2) of Division B.)

- Indirect service water heater\** means a *service water heater* that derives its heat from a heating medium such as warm air, steam or hot water.
- Individual vent* means a *vent pipe* that serves one *fixture*.
- Interceptor* means a receptacle that is installed to prevent oil, grease, sand or other materials from passing into a *drainage system*.
- Leader* means a pipe that is installed to carry *storm water* from a roof to a *storm building drain* or *sewer* or other place of disposal.
- Nominally horizontal* means at an angle of less than 45° with the horizontal. (See Figure A-1.4.1.2.(1)-J in Note A-1.4.1.2.(1).)
- Nominally vertical* means at an angle of not more than 45° with the vertical. (See Figure A-1.4.1.2.(1)-J in Note A-1.4.1.2.(1).)
- Nominal pipe size (NPS)* means the nominal diameter in inches by which the size of a pipe, fitting, *trap* or other similar item is commercially designated.
- Noncombustible\** means that a material meets the acceptance criteria of CAN/ULC-S114, "Standard Method of Test for Determination of Non-Combustibility in Building Materials."
- Occupancy\** means the use or intended use of a *building* or part thereof for the shelter or support of persons, animals or property.
- Offset* means the piping that connects the ends of 2 pipes that are parallel. (See Figure A-1.4.1.2.(1)-K in Note A-1.4.1.2.(1).)
- Offset relief vent* means a *relief vent* that provides additional air circulation upstream and downstream of an *offset* in a *stack*. (See Note A-2.5.4.4.(1) of Division B.)
- Plumbing system\** means a *drainage system*, a *venting system* and a *water system* or parts thereof. (See Figure A-1.4.1.2.(1)-L in Note A-1.4.1.2.(1).)
- Potable* means safe for human consumption.
- Private sewage disposal system\** means a privately owned plant for the treatment and disposal of *sewage* (such as a septic tank with an absorption field).
- Private use* (as applying to the classification of plumbing *fixtures*) means *fixtures* in residences and apartments, in private bathrooms of hotels, and in similar installations in other *buildings* for one family or an individual.
- Private water supply system* means an assembly of pipes, fittings, valves, equipment and appurtenances that supplies water from a private source to a *water distribution system*.
- Public use* (as applying to the classification of plumbing *fixtures*) means *fixtures* in general washrooms of schools, gymnasiums, hotels, bars, public comfort stations and other installations where *fixtures* are installed so that their use is unrestricted.
- Relief vent* means a *vent pipe* that is used in conjunction with a *circuit vent* to provide additional air circulation between a *drainage system* and a *venting system*.
- Residential full flow-through fire sprinkler/standpipe system* means an assembly of pipes and fittings installed in a one- or two-family dwelling that conveys water from the *water service pipe* to the sprinkler/standpipe system's outlets and is fully integrated into the *potable water system* to ensure a regular flow of water through all parts of both systems.
- Residential partial flow-through fire sprinkler/standpipe system* means an assembly of pipes and fittings installed in a one- or two-family dwelling that conveys water from the *water service pipe* to the sprinkler/standpipe system's outlets and in which flow, during inactive periods of the sprinkler/standpipe system, occurs only through the main header to the water closet located at the farthest point of the two systems.
- Riser* means a water distribution pipe that extends through at least one full *storey*.
- Roof drain* means a fitting or device that is installed in the roof to permit *storm water* to discharge into a *leader*.
- Roof gutter* means an exterior channel installed at the base of a sloped roof to convey *storm water*.

*Sanitary building drain* means a *building drain* that conducts *sewage* to a *building sewer* from the most upstream *stack*, *branch* or *fixture drain* serving a water closet.

*Sanitary building sewer* means a *building sewer* that conducts *sewage*.

*Sanitary drainage pipe* means a pipe in a *sanitary drainage system*.

*Sanitary drainage system\** means a *drainage system* that conducts *sewage*.

*Sanitary sewer* means a sewer that conducts *sewage*.

*Service water heater\** means a device for heating water for plumbing services.

*Sewage* means any liquid waste other than *clear-water waste* or *storm water*.

*Stack* means a vertical *sanitary drainage pipe* that passes through one or more *storeys*, and includes any *offset* that is part of the *stack*.

*Stack vent* means a *vent pipe* that connects the top of a *stack* to a *vent header* or to outside air. (See Figure A-1.4.1.2.(1)-G in Note A-1.4.1.2.(1).)

*Storage-type service water heater\** means a *service water heater* with an integral hot water storage tank.

*Storey* for the purposes of this Code, means the interval between 2 successive floor levels, including mezzanine floors that contain plumbing *fixtures*, or between a floor level and roof.

*Storm building drain* means a *building drain* that conducts *storm water* and is connected at its upstream end to a *leader*, sump or catch basin, and at its downstream end to a *building sewer* or a designated *storm water* disposal location.

*Storm building sewer* means a *building sewer* that conveys *storm water*.

*Storm drainage system* means a *drainage system* that conveys *storm water*.

*Storm sewer* means a sewer that conveys *storm water*.

*Storm water* means water that is discharged from a surface as a result of rainfall or snowfall.

*Subsoil drainage pipe* means a pipe that is installed underground to intercept and convey subsurface water.

*Suite\** means a single room or series of rooms of complementary use, operated under a single tenancy, and includes *dwelling units*, individual guest rooms in motels, hotels, boarding houses, rooming houses and dormitories as well as individual stores and individual or complementary rooms for business and personal services *occupancies*.

*Trap* means a fitting or device that is designed to hold a liquid seal that will prevent the passage of gas but will not materially affect the flow of a liquid.

*Trap arm* means that portion of a *fixture drain* between the *trap weir* and the *vent pipe* fitting. (See Note A-2.5.6.3.(1) of Division B.)

*Trap dip* means the lowest part of the upper interior surface of a *trap*.

*Trap seal depth* means the vertical distance between the *trap dip* and the *trap weir*. (See Note A-2.2.3.1.(1) and (3) of Division B.)

*Trap standard* means the *trap* for a *fixture* that is integral with the support for the *fixture*.

*Trap weir* means the highest part of the lower interior surface of a *trap*. (See Note A-2.2.3.1.(1) and (3) of Division B.)

*Treatment\** means the provision of medical or other health-related intervention to persons, where the administration or lack of administration of these interventions may render them incapable of evacuating to a safe location without the assistance of another person. (See Note A-1.4.1.2.(1).)

*Treatment occupancy\** (Group B, Division 2) means the *occupancy* or use of a *building* or part thereof for the provision of *treatment*, and where overnight accommodation is available to facilitate the *treatment*. (See Note A-1.4.1.2.(1).)

*Vacuum breaker* (see *back-siphonage preventer*).

*Vent header* means a *vent pipe* that connects any combination of *stack vents* or *vent stacks* to outside air. (See Figure A-1.4.1.2.(1)-I in Note A-1.4.1.2.(1).)



*Venting system* means an assembly of pipes and fittings that connects a *drainage system* with outside air for circulation of air and the protection of *trap seals* in the *drainage system*. (See Figures A-1.4.1.2.(1)-F and A-1.4.1.2.(1)-G in Note A-1.4.1.2.(1).)

*Vent pipe* means a pipe that is part of a *venting system*.

*Vent stack* means a *vent pipe* that is connected at its upper end to a *vent header* or that terminates in outside air and is connected at its lower end to the *stack* at or below the lowest *sanitary drainage pipe* connection. (See Figure A-1.4.1.2.(1)-G in Note A-1.4.1.2.(1).)

*Water distribution system* means an assembly of pipes, fittings, valves and appurtenances that conveys water from the *water service pipe* or *private water supply system* to water supply outlets, *fixtures*, appliances and devices.

*Water service pipe* means a pipe that conveys water from a public water main or private water source to the inside of the *building*.

*Water system* means a *private water supply system*, a *water service pipe*, a *water distribution system* or parts thereof.

*Wet vent* means a *sanitary drainage pipe* that also serves as a *vent pipe* and extends from the most downstream wet-vented *fixture* connection to the most upstream *fixture* connection. (See Note A-2.5.8.1.(2) of Division B.)

*Yoke vent* means a *vent pipe* that is connected at its lower end to a *stack* and at its upper end to a *vent stack* or to a *branch vent* connected to a *vent stack*. (See Note A-2.5.4.3. of Division B.)

## 1.4.2. Symbols and Other Abbreviations

### 1.4.2.1. Symbols and Other Abbreviations

1) The symbols and other abbreviations in this Code shall have the meanings assigned to them in this Article and in Article 1.3.2.1. of Division B.

ABS .....	acrylonitrile-butadiene-styrene
AL .....	aluminum
cm <sup>2</sup> .....	square centimetre(s)
CPVC .....	chlorinated polyvinyl chloride
° .....	degree(s)
°C .....	degree(s) Celsius
diam. ....	diameter
DWV .....	drain, waste and vent
h .....	hour(s)
in. ....	inch(es)
kg/m <sup>3</sup> .....	kilogram(s) per cubic metre
kPa .....	kilopascal(s)
L .....	litre(s)
Lpf .....	litre(s) per flush
L/s .....	litre(s) per second
m .....	metre(s)
m <sup>2</sup> .....	square metre(s)
max. ....	maximum
min. ....	minimum
min .....	minute(s)
mm .....	millimetre(s)
n/a .....	not applicable

No. ....	number(s)
PE .....	polyethylene
PE-RT .....	polyethylene of raised temperature
PEX .....	crosslinked polyethylene
PP-R .....	polypropylene
PVC .....	polyvinyl chloride
1 in 50 .....	slope of 1 vertical to 50 horizontal

## **Section 1.5. Referenced Documents and Organizations**

### **1.5.1. Referenced Documents**

#### **1.5.1.1. Application of Referenced Documents**

**1)** Except as provided in Sentence (2), the provisions of documents referenced in this Code, and of any documents referenced within those documents, apply only to the extent that they relate to

- a) *plumbing systems*, and
- b) the objectives and functional statements attributed to the applicable acceptable solutions in Division B where the documents are referenced.

(See Note A-1.5.1.1.(1).)

**2)** Where a provision of this Code references another National Model Code, the applicable objectives and functional statements shall include those found in that referenced National Model Code.

#### **1.5.1.2. Conflicting Requirements**

**1)** In case of conflict between the provisions of this Code and those of a referenced document, the provisions of this Code shall govern.

#### **1.5.1.3. Applicable Editions**

**1)** Where documents are referenced in this Code, they shall be the editions designated in Subsection 1.3.1. of Division B.

### **1.5.2. Organizations**

#### **1.5.2.1. Abbreviations of Proper Names**

**1)** The abbreviations of proper names in this Code shall have the meanings assigned to them in Article 1.3.2.1. of Division B.



# Notes to Part 1 Compliance

**A-1.2.1.1.(1)(a) Code Compliance via Acceptable Solutions.** If a plumbing system design (e.g., material, component, assembly or system) can be shown to meet all provisions of the applicable acceptable solutions in Division B (e.g., it complies with the applicable provisions of a referenced standard), it is deemed to have satisfied the objectives and functional statements linked to those provisions and thus to have complied with that part of the Code. In fact, if it can be determined that a design meets all the applicable acceptable solutions in Division B, there is no need to consult the objectives and functional statements in Division A to determine its compliance.

**A-1.2.1.1.(1)(b) Code Compliance via Alternative Solutions.** Where a design differs from the acceptable solutions in Division B, then it should be treated as an “alternative solution.” A proponent of an alternative solution must demonstrate that the alternative solution addresses the same issues as the applicable acceptable solutions in Division B and their attributed objectives and functional statements. However, because the objectives and functional statements are entirely qualitative, demonstrating compliance with them in isolation is not possible. Therefore, Clause 1.2.1.1.(1)(b) identifies the principle that Division B establishes the quantitative performance targets that alternative solutions must meet. In many cases, these targets are not defined very precisely by the acceptable solutions—certainly far less precisely than would be the case with a true performance code, which would have quantitative performance targets and prescribed methods of performance measurement for all aspects of building performance. Nevertheless, Clause 1.2.1.1.(1)(b) makes it clear that an effort must be made to demonstrate that an alternative solution will perform as well as a design that would satisfy the applicable acceptable solutions in Division B—not “well enough” but “as well as.”

In this sense, it is Division B that defines the boundaries between acceptable risks and the “unacceptable” risks referred to in the statements of the Code's objectives, i.e., the risk remaining once the applicable acceptable solutions in Division B have been implemented represents the residual level of risk deemed to be acceptable by the broad base of Canadians who have taken part in the consensus process used to develop the Code.

### Level of Performance

Where Division B offers a choice between several possible designs, it is likely that these designs may not all provide exactly the same level of performance. Among a number of possible designs satisfying acceptable solutions in Division B, the design providing the lowest level of performance should generally be considered to establish the minimum acceptable level of performance to be used in evaluating alternative solutions for compliance with the Code.

Sometimes a single design will be used as an alternative solution to several sets of acceptable solutions in Division B. In this case, the level of performance required of the alternative solution should be at least equivalent to the overall level of performance established by all the applicable sets of acceptable solutions taken as a whole.

Each provision in Division B has been analyzed to determine what it is intended to achieve. The resultant intent statements clarify what undesirable results each provision seeks to preclude. These statements are not a legal component of the Code, but are advisory in nature, and can help Code users establish

---

These Notes are included for explanatory purposes only and do not form part of the requirements. The number that introduces each Note corresponds to the applicable requirement in this Part.

The figures are schematic only; they depict various parts of the plumbing system but do not include details. For an explanation of the symbols and abbreviations used in the figures, refer to the list provided at the end of the Code.

performance targets for alternative solutions. They are published as a separate electronic document entitled "Supplement to the NPC 2020: Intent Statements," which is available on the NRC's website.

### **Areas of Performance**

A subset of the acceptable solutions in Division B may establish criteria for particular types of designs (e.g., certain types of materials, components, assemblies, or systems). Often such subsets of acceptable solutions are all attributed to the same objective: OH2, Sanitation, for example. In some cases, the designs that are normally used to satisfy this subset of acceptable solutions might also provide some benefits that could be related to some other objective: OP5, Protection of the Building or Facility from Water and Sewage Damage, for example. However, if none of the applicable acceptable solutions are linked to Objective OP5, it is not necessary that alternative solutions proposed to replace these acceptable solutions provide a similar benefit related to Protection of the Building or Facility from Water and Sewage Damage. In other words, the acceptable solutions in Division B establish acceptable levels of performance for compliance with the Code only in those areas defined by the objectives and functional statements attributed to the acceptable solutions.

### **Applicable Acceptable Solutions**

In demonstrating that an alternative solution will perform as well as a design that would satisfy the applicable acceptable solutions in Division B, its evaluation should not be limited to comparison with the acceptable solutions to which an alternative is proposed. It is possible that acceptable solutions elsewhere in the Code also apply. The proposed alternative solution may be shown to perform as well as the most apparent acceptable solution, which it is replacing, but may not perform as well as other relevant acceptable solutions. For example, an innovative piping material may perform adequately in a drainage system, but may not meet combustibility requirements elsewhere in the Code. All applicable acceptable solutions should be taken into consideration in demonstrating the compliance of an alternative solution.

## **A-1.4.1.2.(1) Defined Terms.**

### **Auxiliary Water Supply**

The auxiliary water supply may include water from a secondary potable water supply or from any natural source, such as a well, lake, spring, stream or harbour. It may also include waste water (but not sanitary drainage) from industrial processes, such as cooling towers, or from storm retention ponds. These sources may be polluted or contaminated and constitute an unacceptable water source over which the primary water purveyor does not have sanitary control. It is generally accepted that there are two categories of auxiliary water supply:

- (a) any public potable water supply over which the primary water purveyor does not have sanitary control, or
- (b) any private water supply, other than the primary potable water supply, that is on or available to the premises.

### **Care Occupancy**

Support services rendered by or through care facility management refer to services provided by the organization that is responsible for the care for a period exceeding 24 consecutive hours. They do not refer to services provided by residents of dwelling units or suites, or to services arranged directly by residents of dwelling units or suites with outside agencies.

In the context of care occupancies, these services may include a daily assessment of the resident's functioning, awareness of their whereabouts, the making of appointments for residents and reminding them of those appointments, the ability and readiness to intervene if a crisis arises for a resident, supervision in areas of nutrition or medication, and provision of transient medical services. Services may also include activities of daily living such as bathing, dressing, feeding, and assistance in the use of washroom facilities, etc. No actual treatment is provided by or through care facility management.

### **Class 3 Fire Sprinkler/Standpipe Systems**

In Class 3 fire sprinkler/standpipe systems, water is supplied to the storage facilities from the public water supply and is maintained in potable condition. Class 3 fire sprinkler/standpipe systems resemble Class 1 fire sprinkler/standpipe systems in all other respects.

**Clear-Water Waste**

Examples of clear-water waste are the waste waters discharged from a drinking fountain, cooling jacket, air conditioner or relief valve outlet.

**Emergency Floor Drains**

There are two types of floor drains. One is an emergency floor drain installed to avoid flooding in a building from any pipe or fixture failure. The other encompasses floor drains installed to receive discharge from specific pieces of equipment; this type is defined as a fixture.

**Home-Type Care Occupancy**

Support services rendered to the residents of a home-type care occupancy refer to services provided at a cost by caregivers who are responsible for the care for a period exceeding 24 consecutive hours. They do not refer to services provided by family members of the residents, or to services arranged directly by residents with outside agencies.

In the context of home-type care occupancies, these services may include a daily assessment of the resident's functioning, awareness of their whereabouts, the making of appointments for residents and reminding them of those appointments, the ability and readiness to intervene if a crisis arises for a resident, supervision in areas of nutrition or medication, and provision of transient medical services. Services may also include activities of daily living such as bathing, dressing, feeding, and assistance in the use of washroom facilities, etc. No actual treatment is provided by the caregivers.

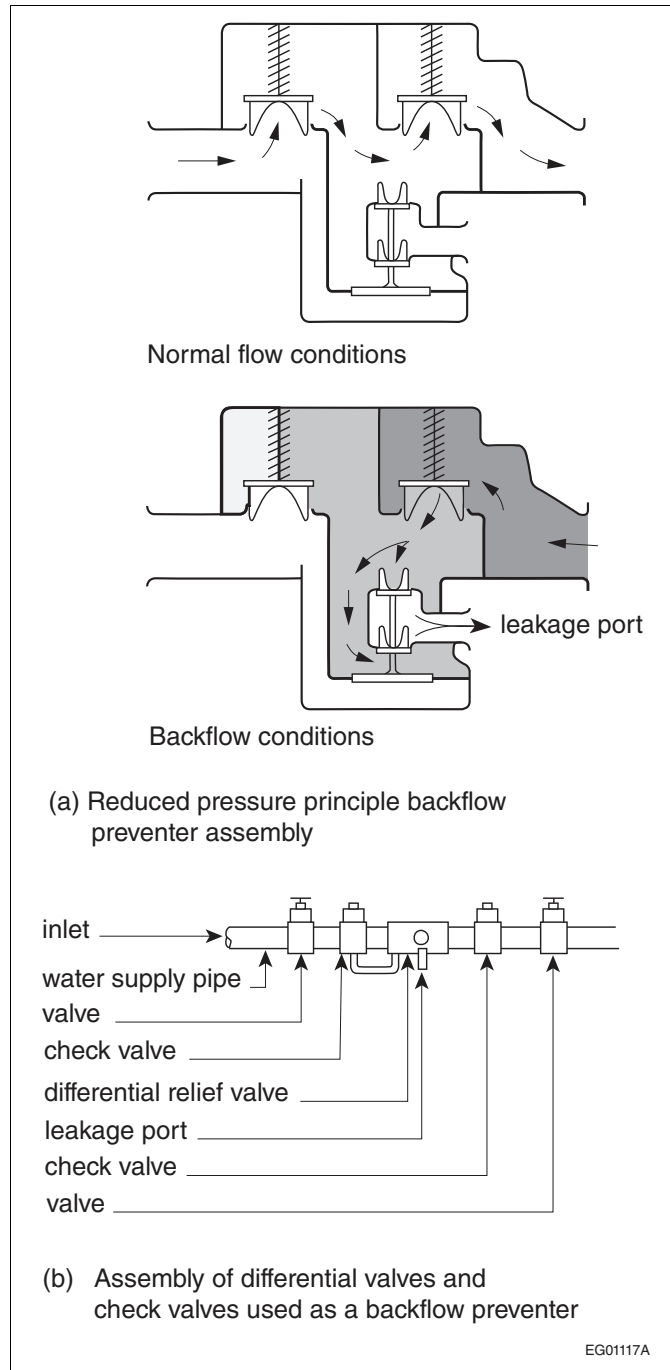
**Treatment**

The ability to evacuate unassisted implies that a person is capable of recognizing and responding to an emergency given their physical, cognitive and behavioural abilities, and able to move to a safe location without the assistance of another person. For example, such persons must be able to arise and walk, or transfer from a bed or chair to a means of mobility, and leave the building or move to a safe location on their own.

**Treatment Occupancy**

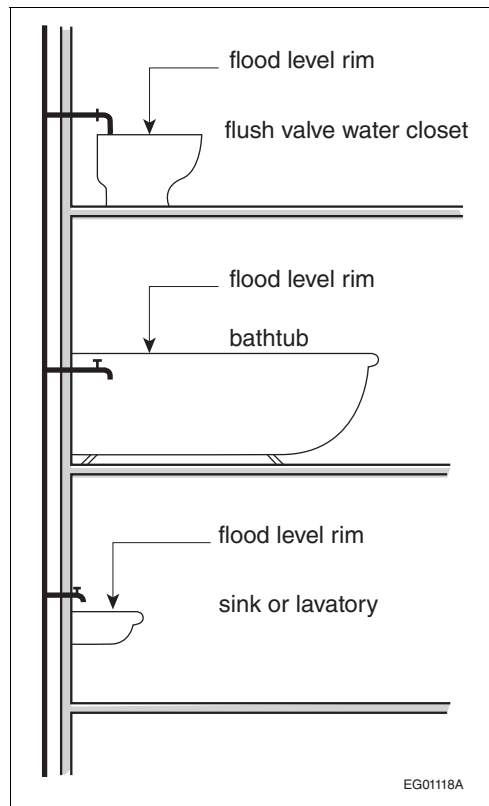
"Treatments" may include such things as surgery, intensive care, and emergency medical intervention. Treatment services differ from the services provided by care occupancies like personal care assistance or the administration of medication, and from those provided by business and personal services occupancies like dentistry or day procedures.

**Illustrations for Defined Terms**



**Figure A-1.4.1.2.(1)-A  
Backflow preventer**

© His Majesty the King in Right of Canada, as represented by the National Research Council of Canada, 2025 © Sa Majesté le Roi du chef du Canada, représenté par le Conseil national de recherches du Canada, 2025

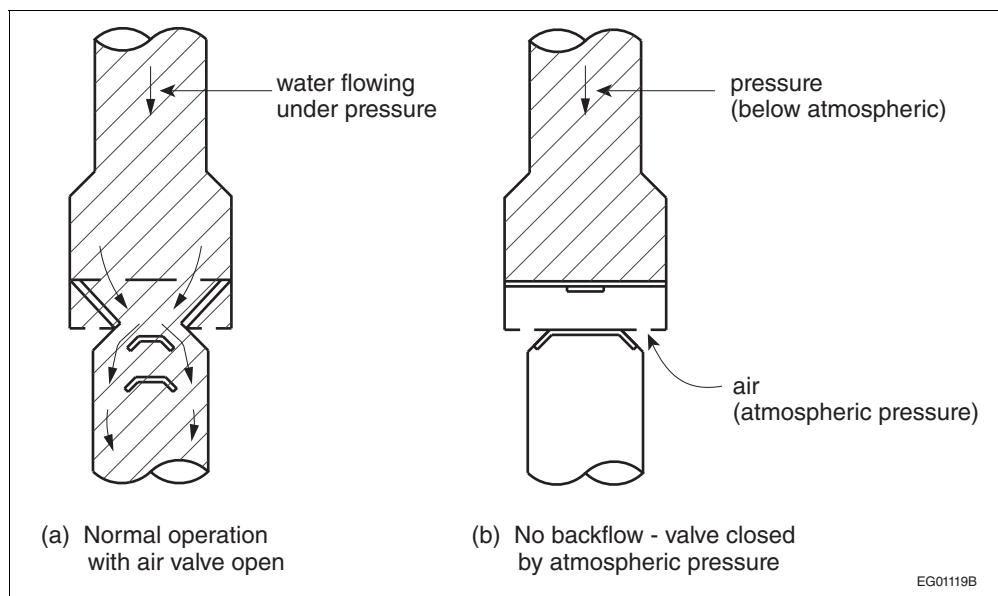


**Figure A-1.4.1.2.(1)-B**

**Back-siphonage**

**Notes to Figure A-1.4.1.2.(1)-B:**

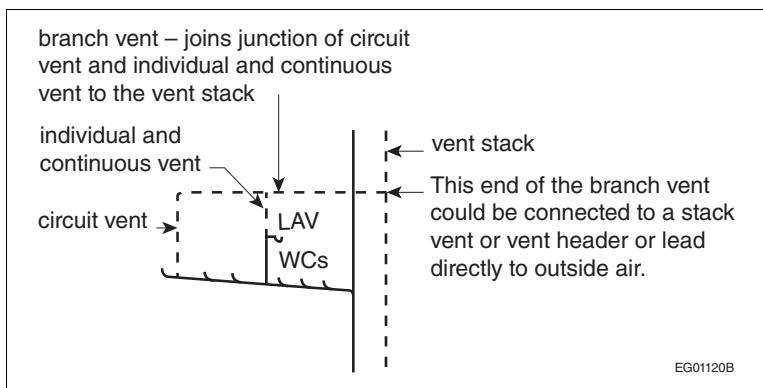
- (1) Figure A-1.4.1.2.(1)-B shows a situation that is fairly common in old buildings. If the bathtub is filled to a level above the faucet outlet, or if the flush valve of the water closet is faulty, and if the faucet at the sink or lavatory on the lower floor is opened, water can be drawn (siphoned) from the bathtub or the water closet into the water system when the pressure in the water system is low or the water supply has been shut off.
- (2) Back-siphonage can be prevented in the above situations by providing an air gap or a back-siphonage preventer (see Subsection 2.6.2. of Division B).



**Figure A-1.4.1.2.(1)-C**

**Back-siphonage preventer**



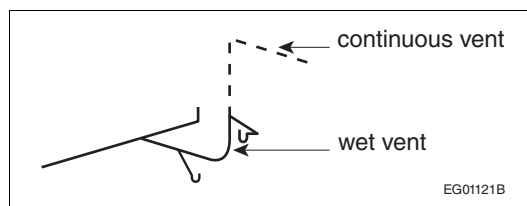


**Figure A-1.4.1.2.(1)-D**

**Branch vent**

**Note to Figure A-1.4.1.2.(1)-D:**

(1) See also the definitions of header and drainage system in Article 1.4.1.2.



**Figure A-1.4.1.2.(1)-E**

**Continuous vent**

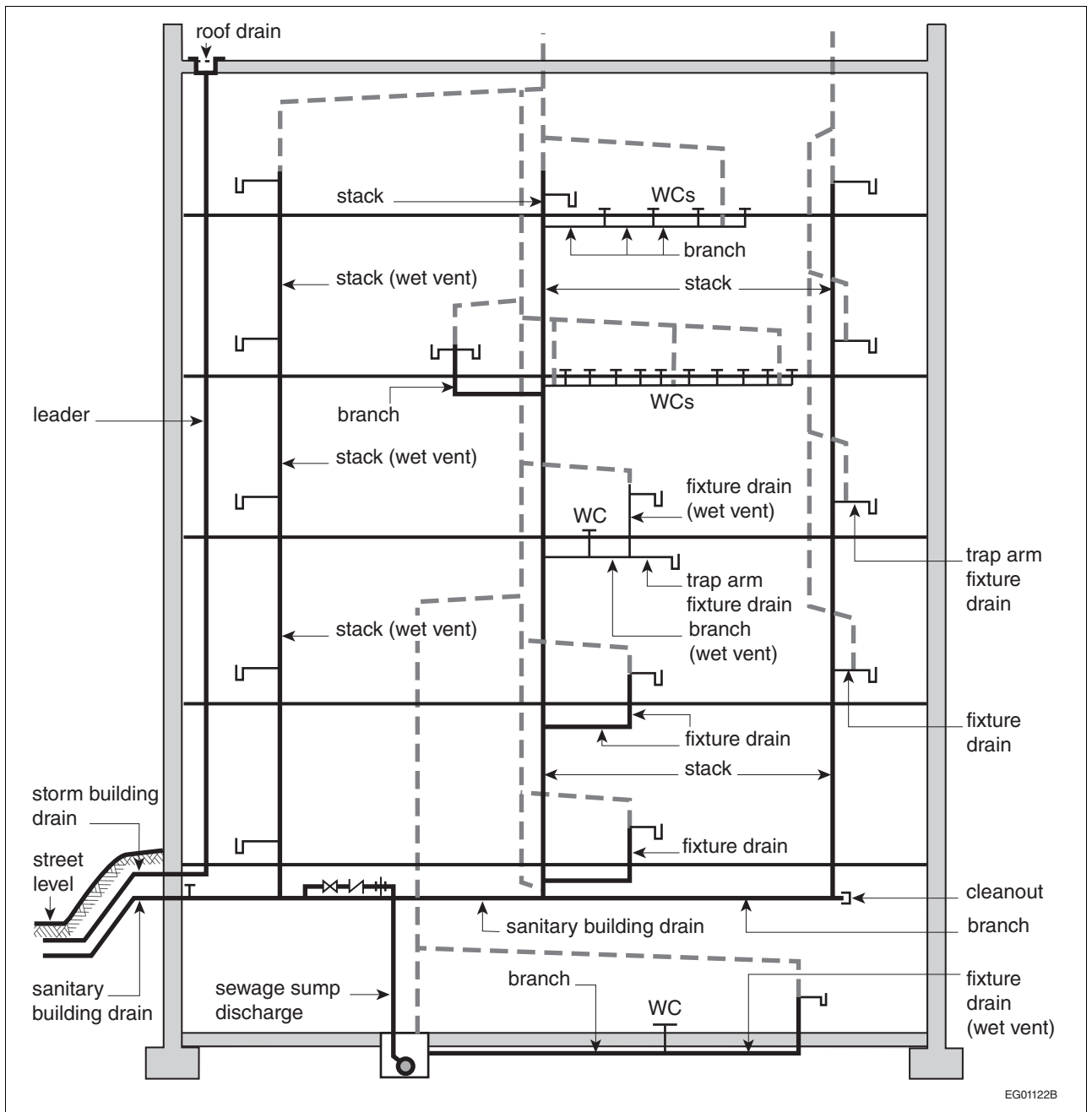
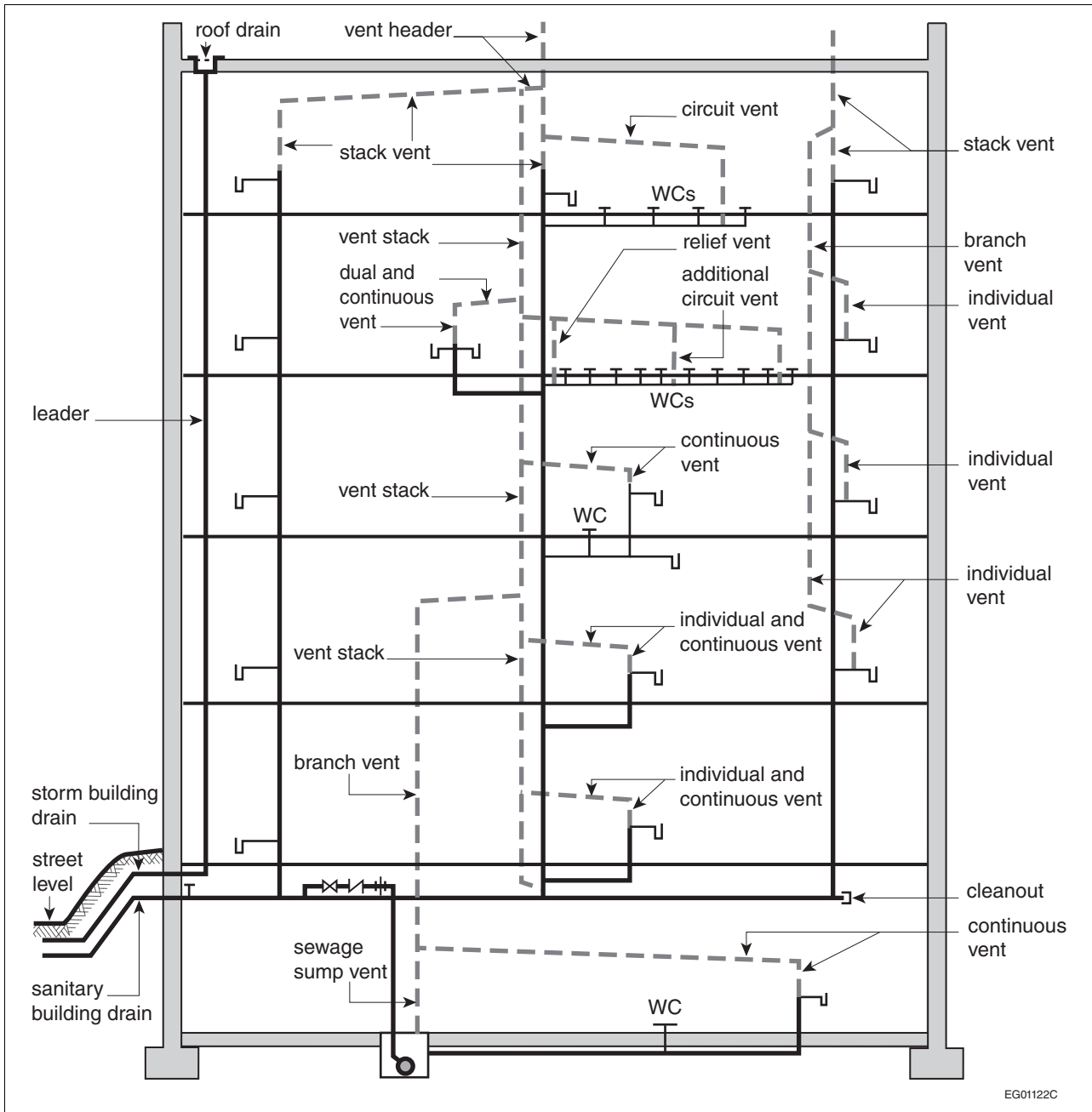


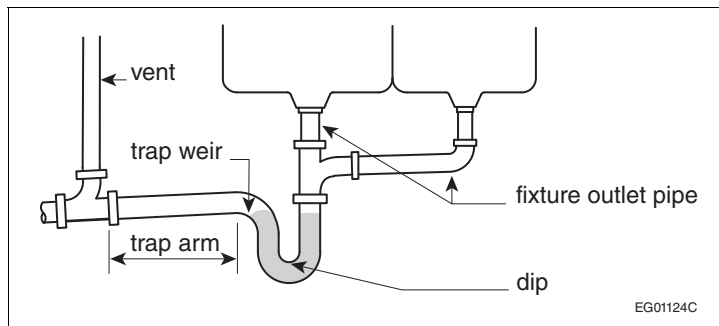
Figure A-1.4.1.2.(1)-F  
Drainage system

EG01122B



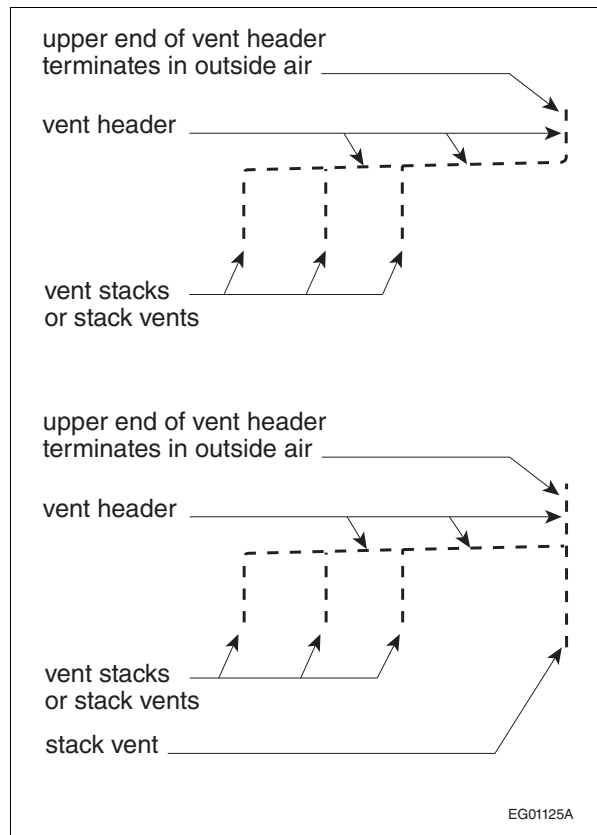
EG01122C

**Figure A-1.4.1.2.(1)-G**  
**Venting system**



EG01124C

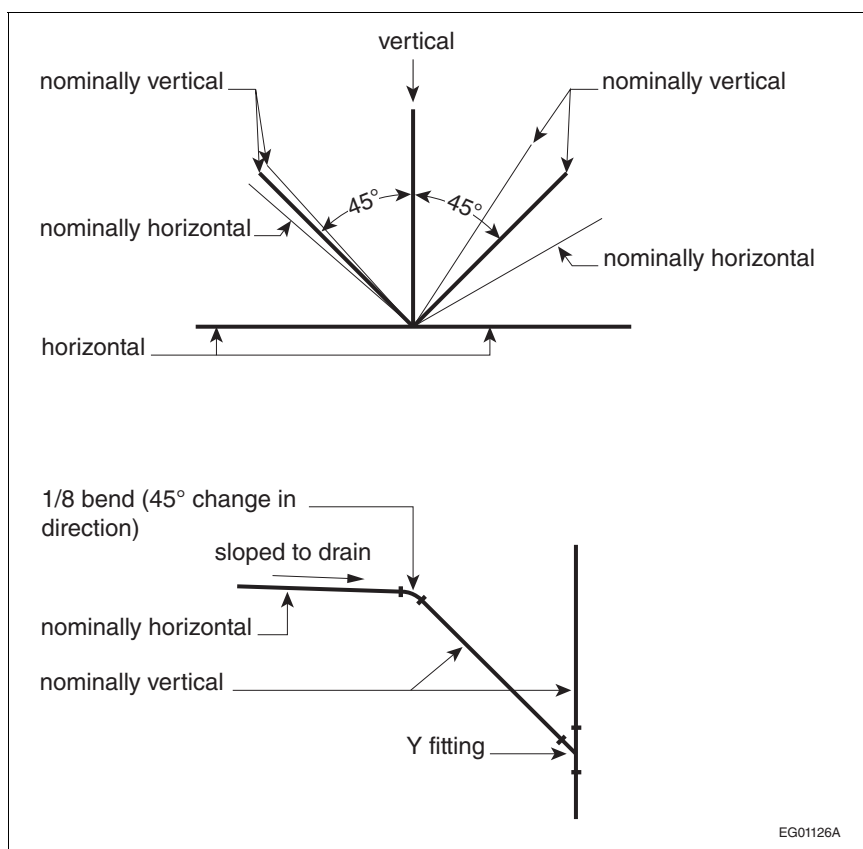
**Figure A-1.4.1.2.(1)-H**  
**Fixture outlet pipe and trap arm**



**Figure A-1.4.1.2.(1)-I**  
**Vent header**

**Note to Figure A-1.4.1.2.(1)-I:**

- (1) Although a vent header is similar to a branch vent, it serves the special purpose of connecting the tops of stack vents or vent stacks. To make certain that it is adequate for that purpose, it is made larger than a branch vent. The developed length used to determine its size is the total length from the most distant sanitary drainage pipe to outside air, rather than the shorter length used to size a branch vent.



**Figure A-1.4.1.2.(1)-J**  
**Nominally horizontal and nominally vertical**

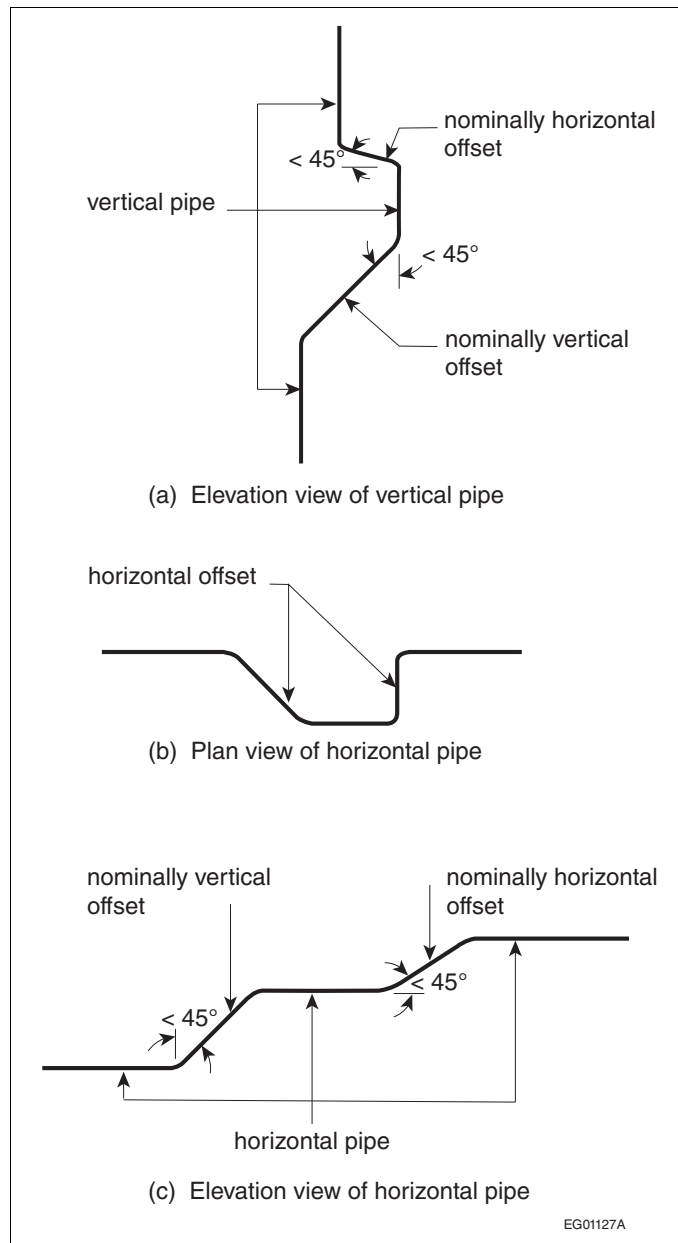


Figure A-1.4.1.2.(1)-K  
Offset

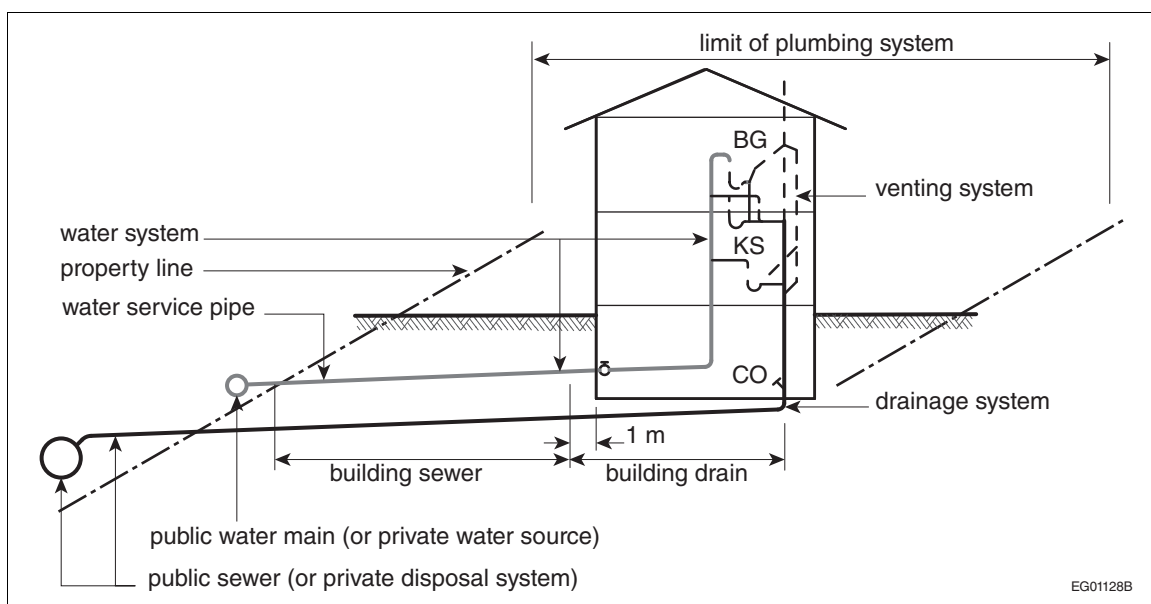


Figure A-1.4.1.2.(1)-L  
Plumbing system

**A-1.5.1.1.(1) Application of Referenced Documents.** Documents referenced in the NPC may contain provisions covering a wide range of issues, including issues that are unrelated to the objectives and functional statements stated in Parts 2 and 3 of Division A, respectively. Sentence 1.5.1.1.(1) is intended to make it clear that, whereas referencing these documents in the NPC generally has the effect of making the provisions of those documents part of the Code, provisions that are unrelated to plumbing systems or to the objectives and functional statements attributed to the provisions in Division B where the document is referenced are excluded.

Furthermore, many documents referenced in the NPC contain references to other documents, which may also, in turn, refer to other documents. These secondary and tertiary referenced documents may contain provisions that are unrelated to plumbing systems or to the objectives and functional statements of the NPC: such provisions—no matter how far down the chain of references they occur—are not included in the intent of Sentence 1.5.1.1.(1).

---

**Division A**

# Part 2 Objectives

<b>2.1.</b>	<b>Application</b>	
2.1.1.	Application .....	2-1
<b>2.2.</b>	<b>Objectives</b>	
2.2.1.	Objectives .....	2-1
	<b>Notes to Part 2 .....</b>	<b>2-5</b>





## Division A

# Part 2 Objectives

## Section 2.1. Application

### 2.1.1. Application

#### 2.1.1.1. Application

1) This Part applies to all *plumbing systems* covered in this Code. (See Article 1.1.1.1.)

#### 2.1.1.2. Application of Objectives

- 1) The objectives described in this Part apply
  - a) to all *plumbing systems* covered in this Code (see Article 1.1.1.1.), and
  - b) only to the extent that they relate to compliance with this Code as required in Article 1.2.1.1.

## Section 2.2. Objectives

### 2.2.1. Objectives

#### 2.2.1.1. Objectives

- 1) The objectives of this Code are as follows (see Note A-2.2.1.1.(1)):

#### **OS Safety**

An objective of this Code is to limit the probability that, as a result of the design or installation of the *plumbing system*, a person in or adjacent to the *building* or facility will be exposed to an unacceptable risk of injury.

#### **OS1 Fire Safety**

An objective of this Code is to limit the probability that, as a result of the design or installation of the *plumbing system*, a person in or adjacent to the *building* or facility will be exposed to an unacceptable risk of injury due to fire. The risks of injury due to fire addressed in this Code are those caused by—

- OS1.1 – fire or explosion occurring
- OS1.4 – fire safety systems failing to function as expected

#### **OS2 Structural Safety**

An objective of this Code is to limit the probability that, as a result of the design or installation of the *plumbing system*, a person in or adjacent to the *building* will be exposed to an unacceptable risk of injury due to structural failure. The risks of injury due to structural failure addressed in this Code are those caused by—

- OS2.1 – loads bearing on the *building* elements that exceed their load-bearing capacity

**OS3 Safety in Use**

An objective of this Code is to limit the probability that, as a result of the design or installation of the *plumbing system*, a person in or adjacent to the *building* or facility will be exposed to an unacceptable risk of injury due to hazards. The risks of injury due to hazards addressed in this Code are those caused by—

- OS3.1 – tripping, slipping, falling, contact, drowning or collision
- OS3.2 – contact with hot surfaces or substances
- OS3.4 – exposure to hazardous substances

**OH Health**

An objective of this Code is to limit the probability that, as a result of the design or installation of the *plumbing system*, a person will be exposed to an unacceptable risk of illness.

**OH1 Indoor Conditions**

An objective of this Code is to limit the probability that, as a result of the design or installation of the *plumbing system*, a person in the *building* or facility will be exposed to an unacceptable risk of illness due to indoor conditions. The risks of illness due to indoor conditions addressed in this Code are those caused by—

- OH1.1 – inadequate indoor air quality

**OH2 Sanitation**

An objective of this Code is to limit the probability that, as a result of the design or installation of the *plumbing system*, a person in the *building* or facility will be exposed to an unacceptable risk of illness due to unsanitary conditions. The risks of illness due to unsanitary conditions addressed in this Code are those caused by—

- OH2.1 – exposure to human or domestic waste
- OH2.2 – consumption of contaminated water
- OH2.3 – inadequate facilities for personal hygiene
- OH2.4 – contact with contaminated surfaces

**OH5 Hazardous Substances Containment**

An objective of this Code is to limit the probability that, as a result of the design or installation of the *plumbing system*, the public will be exposed to an unacceptable risk of illness due to the release of hazardous substances from the *building* or facility.

**OP Protection of the Building or Facility from Water and Sewage Damage****OP5 Protection of the Building or Facility from Water and Sewage Damage**

An objective of this Code is to limit the probability that, as a result of the design or installation of the *plumbing system*, the *building* or facility will be exposed to an unacceptable risk of damage due to the leakage of service water or *sewage*.

**OE Environment**

An objective of this Code is to limit the probability that, as a result of the design or installation of the *plumbing system*, the environment will be affected in an unacceptable manner.

**OE1 Resources**

An objective of this Code is to limit the probability that, as a result of the design or installation of the *plumbing system*, resources will be used in a manner that will have an unacceptable effect on the environment. The risks of unacceptable effect on the environment due to use of resources addressed in this Code are those caused by—

OE1.2 – excessive use of water



---

## **Division A**

# **Notes to Part 2 Objectives**

### **A-2.2.1.1.(1) Objectives.**

#### **Listing of objectives**

Any gaps in the numbering sequence of the objectives are due to the fact that there is a master list of objectives covering the four principal National Code Documents—the National Building Code, the National Energy Code for Buildings, the National Fire Code and the National Plumbing Code—but not all objectives are pertinent to all Codes.

#### **The building or facility**

Where the term “the building or facility” is used in the wording of the objectives, it refers to the building or facility for which compliance with the National Plumbing Code is being assessed.

#### **Fire Safety**

In the definition of Objective OS1, Fire Safety, the term “person” refers to any individual in or adjacent to the building or facility, including the occupants, the public, and emergency responders including firefighters when performing their duties.

Certain technical requirements in the National Model Codes are intended to address the safety of emergency responders, including firefighters, when performing their duties.

---

These Notes are included for explanatory purposes only and do not form part of the requirements. The number that introduces each Note corresponds to the applicable requirement in this Part.



---

**Division A**

# **Part 3**

## **Functional Statements**

<b>3.1.</b>	<b>Application</b>	
3.1.1.	Application .....	3-1
<b>3.2.</b>	<b>Functional Statements</b>	
3.2.1.	Functional Statements .....	3-1
	<b>Notes to Part 3</b> .....	<b>3-3</b>





## Division A

# Part 3 Functional Statements

## Section 3.1. Application

### 3.1.1. Application

#### 3.1.1.1. Application

1) This Part applies to all *plumbing systems* covered in this Code. (See Article 1.1.1.1.)

#### 3.1.1.2. Application of Functional Statements

- 1) The functional statements described in this Part apply
  - a) to all *plumbing systems* covered in this Code (see Article 1.1.1.1.), and
  - b) only to the extent that they relate to compliance with this Code as required in Article 1.2.1.1.

## Section 3.2. Functional Statements

### 3.2.1. Functional Statements

#### 3.2.1.1. Functional Statements

1) The objectives of this Code are achieved by measures, such as those described in the acceptable solutions in Division B, that are intended to allow the *plumbing system* to perform the following functions (see Note A-3.2.1.1.(1)):

- F01** To minimize the risk of accidental ignition.
- F02** To limit the severity and effects of fire or explosions.
- F20** To support and withstand expected loads and forces.
- F21** To limit or accommodate dimensional change.
- F30** To minimize the risk of injury to persons as a result of tripping, slipping, falling, contact, drowning or collision.
- F31** To minimize the risk of injury to persons as a result of contact with hot surfaces or substances.
- F40** To limit the level of contaminants.
- F41** To minimize the risk of generation of contaminants.
- F43** To minimize the risk of release of hazardous substances.
- F45** To minimize the risk of the spread of disease through communal shower facilities.
- F46** To minimize the risk of contamination of *potable* water.

### 3.2.1.1.

## Division A

- F62** To facilitate the dissipation of water and moisture from the *building*.
- F70** To provide *potable* water.
- F71** To provide facilities for personal hygiene.
- F72** To provide facilities for the sanitary disposal of human and domestic wastes.
- F80** To resist deterioration resulting from expected service conditions.
- F81** To minimize the risk of malfunction, interference, damage, tampering, lack of use or misuse.
- F82** To minimize the risk of inadequate performance due to improper maintenance or lack of maintenance.
- F130** To limit the unnecessary demand and/or consumption of water for *fixtures*.
- F131** To limit the unnecessary demand and/or consumption of water for fittings.

# Notes to Part 3

## Functional Statements

**A-3.2.1.1.(1) Listing of Functional Statements.** The numbered functional statements are grouped according to functions that deal with closely related subjects. For example, the first group deals with fire risks, the second group deals with the structural properties of piping materials, etc. There may be gaps in the numbering sequence for the following reasons:

- Each group has unused numbers which allows for the possible future creation of additional functional statements within any one group.
- There is a master list of functional statements covering the four principal National Code Documents—the National Building Code, the National Energy Code for Buildings, the National Fire Code and the National Plumbing Code—but not all functional statements are pertinent to all Codes.

---

These Notes are included for explanatory purposes only and do not form part of the requirements. The number that introduces each Note corresponds to the applicable requirement in this Part.



---

# **Division B**

## **Acceptable Solutions**



---

## **Division B**

# **Part 1 General**

<b>1.1.</b>	<b>General</b>	
1.1.1.	Application .....	1-1
1.1.2.	Objectives and Functional Statements .....	1-1
<b>1.2.</b>	<b>Terms and Abbreviations</b>	
1.2.1.	Definitions of Words and Phrases ..	1-1
1.2.2.	Symbols and Other Abbreviations ..	1-2
<b>1.3.</b>	<b>Referenced Documents and Organizations</b>	
1.3.1.	Referenced Documents .....	1-2
1.3.2.	Organizations .....	1-8
	<b>Notes to Part 1 .....</b>	<b>1-11</b>





# Part 1 General

## Section 1.1. General

### 1.1.1. Application

#### 1.1.1.1. Application

**1)** This Part applies to all *plumbing systems* covered in this Code. (See Article 1.1.1.1. of Division A.)

### 1.1.2. Objectives and Functional Statements

#### 1.1.2.1. Attribution to Acceptable Solutions

**1)** For the purposes of compliance with this Code as required in Clause 1.2.1.1.(1)(b) of Division A, the objectives and functional statements attributed to the acceptable solutions in Division B shall be the objectives and functional statements identified in Section 2.8. (See Note A-1.1.2.1.(1).)

## Section 1.2. Terms and Abbreviations

### 1.2.1. Definitions of Words and Phrases

#### 1.2.1.1. Non-defined Terms

**1)** Words and phrases used in Division B that are not included in the list of definitions in Article 1.4.1.2. of Division A shall have the meanings that are commonly assigned to them in the context in which they are used, taking into account the specialized use of terms by the various trades and professions to which the terminology applies.

**2)** Where objectives and functional statements are referred to in Division B, they shall be the objectives and functional statements described in Parts 2 and 3 of Division A.

**3)** Where acceptable solutions are referred to in Division B, they shall be the provisions stated in Part 2.

#### 1.2.1.2. Defined Terms

**1)** The words and terms in italics in Division B shall have the meanings assigned to them in Article 1.4.1.2. of Division A.

**1.2.2.1.**

**1.2.2. Symbols and Other Abbreviations**

**1.2.2.1. Symbols and Other Abbreviations**

1) The symbols and other abbreviations in Division B shall have the meanings assigned to them in Article 1.4.2.1. of Division A and Article 1.3.2.1.

**Section 1.3. Referenced Documents and Organizations**

**1.3.1. Referenced Documents**

**1.3.1.1. Effective Date**

1) Unless otherwise specified herein, the documents referenced in this Code shall include all amendments, revisions, reaffirmations, reapprovals, addenda and supplements effective to 15 July 2022.

**1.3.1.2. Applicable Editions**

1) Where documents are referenced in this Code, they shall be the editions designated in Table 1.3.1.2.

**Table 1.3.1.2.**  
**Documents Referenced in the National Plumbing Code of Canada 2020<sup>(1)</sup>**  
 Forming Part of Sentence 1.3.1.2.(1)

Issuing Agency	Document Number <sup>(2)</sup>	Title of Document	Code Reference
ANSI/CSA	ANSI Z21.22-2015/CSA 4.4-2015	Relief Valves For Hot Water Supply Systems	2.2.10.11.(1)
ARCSA/ASPE/ANSI	63-2013	Rainwater Catchment Systems	A-2.7.2.4.(1)
ASHRAE	2011	ASHRAE Handbook – HVAC Applications	A-2.6.3.1.(2)
ASHRAE	2013	ASHRAE Handbook – Fundamentals	A-2.6.3.1.(2)
ASME/CSA	ASME A112.3.4-2018/CSA B45.9-18	Macerating Toilet Systems and Waste-Pumping Systems for Plumbing Fixtures	2.2.2.2.(1)
ASME/CSA	ASME A112.4.2-2021/CSA B45.16:21	Personal hygiene devices for water closets	2.2.2.2.(1)
ASME/CSA	ASME A112.4.14-2017/CSA B125.14-17	Manually Operated Valves for Use in Plumbing Systems	2.2.10.6.(7)
ASME/CSA	ASME A112.18.1-2018/CSA B125.1-18	Plumbing Supply Fittings	2.2.10.6.(1) 2.2.10.7.(1)
ASME/CSA	ASME A112.18.2-2020/CSA B125.2:20	Plumbing Waste Fittings	2.2.3.3.(1) 2.2.10.6.(6)
ASME/CSA	ASME A112.18.6-2017/CSA B125.6-17	Flexible water connectors	2.2.10.18.(1)
ASME/CSA	ASME A112.19.1-2018/CSA B45.2-18	Enamelled Cast Iron and Enamelled Steel Plumbing Fixtures	2.2.2.2.(1)
ASME/CSA	ASME A112.19.2-2018/CSA B45.1-18	Ceramic Plumbing Fixtures	2.2.2.2.(1)
ASME/CSA	ASME A112.19.3-2017/CSA B45.4-17	Stainless Steel Plumbing Fixtures	2.2.2.2.(1)
ASME/CSA	ASME A112.19.7-2020/CSA B45.10:20	Hydromassage bathtub systems	2.2.2.2.(1)
ASME	B16.3-2021	Malleable Iron Threaded Fittings: Classes 150 and 300	2.2.6.6.(1) A-2.2.5. to 2.2.8.
ASME	B16.4-2021	Gray Iron Threaded Fittings: Classes 125 and 250	2.2.6.5.(1) A-2.2.5. to 2.2.8.
ASME	B16.5-2020	Pipe Flanges and Flanged Fittings: NPS ½ through NPS 24 Metric/Inch Standard	2.2.6.12.(1)
ASME	B16.9-2018	Factory-Made Wrought Buttwelding Fittings	2.2.6.11.(1) 2.2.6.14.(1)

**Table 1.3.1.2. (Continued)**

Issuing Agency	Document Number <sup>(2)</sup>	Title of Document	Code Reference
ASME	B16.12-2019	Cast Iron Threaded Drainage Fittings	2.2.6.3.(1)
ASME	B16.15-2018	Cast Copper Alloy Threaded Fittings: Classes 125 and 250	2.2.7.3.(1) A-2.2.5. to 2.2.8.
ASME	B16.18-2021	Cast Copper Alloy Solder Joint Pressure Fittings	2.2.7.6.(1) 2.2.7.6.(2) A-2.2.5. to 2.2.8.
ASME	B16.22-2021	Wrought Copper and Copper Alloy Solder-Joint Pressure Fittings	2.2.7.6.(1) A-2.2.5. to 2.2.8.
ASME	B16.23-2016	Cast Copper Alloy Solder Joint Drainage Fittings: DWV	2.2.7.5.(1) A-2.2.5. to 2.2.8.
ASME	B16.24-2016	Cast Copper Alloy Pipe Flanges, Flanged Fittings, and Valves: Classes 150, 300, 600, 900, 1500, and 2500	2.2.7.2.(1)
ASME	B16.26-2018	Cast Copper Alloy Fittings for Flared Copper Tubes	2.2.7.7.(1) 2.2.7.7.(2)
ASME	B16.29-2017	Wrought Copper and Wrought Copper Alloy Solder-Joint Drainage Fittings – DWV	2.2.7.5.(1) A-2.2.5. to 2.2.8.
ASME	B31.9-2020	Building Services Piping	2.3.2.8.(1)
ASME	B36.19M-2018	Stainless Steel Pipe	2.2.6.10.(1)
ASPE	2010	Plumbing Engineering Design Handbook, Volume 2	A-2.6.3.1.(2)
ASPE	2012	Plumbing Engineering Design Handbook, Volume 4, Chapter 8, Grease Interceptors	A-2.4.4.3.(1)
ASSE/ASME/CSA	ASSE 1002-2020/ASME A112.1002-2020/CSA B125.12-20	Anti-siphon fill valves for water closet tanks	2.2.10.10.(2)
ASSE	ANSI/ASSE 1010-2021	Water Hammer Arresters	2.2.10.15.(1)
ASSE/ASME/CSA	ASSE 1016-2017/ASME A112.1016-2017/CSA B125.16-17	Performance Requirements for Automatic Compensating Valves for Individual Showers and Tub/Shower Combinations	2.2.10.7.(1) A-2.2.10.6.(3)
ASSE/ASME/CSA	ASSE 1037-2020/ASME A112.1037-2020/CSA B125.37-20	Performance requirements for pressurized flushing devices for plumbing fixtures	2.2.10.8.(1)
ASSE	1051-2021	Individual and Branch Type Air Admittance Valves for Sanitary Drainage Systems	2.2.10.16.(1)
ASSE/ASME/CSA	ASSE 1070-2020/ASME A112.1070-2020/CSA B125.70-20	Performance requirements for water temperature limiting devices	2.2.10.7.(2)
ASTM	A53/A53M-20	Standard Specification for Pipe, Steel, Black and Hot-Dipped, Zinc-Coated, Welded and Seamless	2.2.6.7.(4) A-2.2.5. to 2.2.8.
ASTM	A182/A182M-21	Standard Specification for Forged or Rolled Alloy and Stainless Steel Pipe Flanges, Forged Fittings, and Valves and Parts for High-Temperature Service	2.2.6.12.(1) 2.2.6.13.(1)
ASTM	A269/A269M-15a	Standard Specification for Seamless and Welded Austenitic Stainless Steel Tubing for General Service	2.2.6.14.(1) A-2.2.5. to 2.2.8.
ASTM	A312/A312M-22	Standard Specification for Seamless, Welded, and Heavily Cold Worked Austenitic Stainless Steel Pipes	2.2.6.10.(1) A-2.2.5. to 2.2.8.
ASTM	A351/A351M-18e1	Standard Specification for Castings, Austenitic, for Pressure-Containing Parts	2.2.6.13.(1)
ASTM	A403/A403M-22	Standard Specification for Wrought Austenitic Stainless Steel Piping Fittings	2.2.6.11.(1)
ASTM	A518/A518M-99	Standard Specification for Corrosion-Resistant High-Silicon Iron Castings	2.2.8.1.(1)
ASTM	B32-20	Standard Specification for Solder Metal	2.2.9.2.(1)
ASTM	B42-20	Standard Specification for Seamless Copper Pipe, Standard Sizes	2.2.7.1.(1) A-2.2.5. to 2.2.8.

Table 1.3.1.2. (Continued)

Issuing Agency	Document Number <sup>(2)</sup>	Title of Document	Code Reference
ASTM	B43-20	Standard Specification for Seamless Red Brass Pipe, Standard Sizes	2.2.7.1.(2) A-2.2.5. to 2.2.8.
ASTM	B88-20	Standard Specification for Seamless Copper Water Tube	2.2.7.4.(1) A-2.2.5. to 2.2.8.
ASTM	B306-20	Standard Specification for Copper Drainage Tube (DWV)	2.2.7.4.(1) A-2.2.5. to 2.2.8.
ASTM	B813-16	Standard Specification for Liquid and Paste Fluxes for Soldering of Copper and Copper Alloy Tube	2.2.9.2.(3)
ASTM	B828-16	Standard Specification for Making Capillary Joints by Soldering of Copper and Copper Alloy Tube and Fittings	2.3.2.4.(1)
ASTM	C1053-00	Standard Specification for Borosilicate Glass Pipe and Fittings for Drain, Waste, and Vent (DWV) Applications	2.2.8.1.(1)
ASTM	D2466-21	Standard Specification for Poly(Vinyl Chloride) (PVC) Plastic Pipe Fittings, Schedule 40	2.2.5.7.(2) A-2.2.5. to 2.2.8.
ASTM	D2467-20	Standard Specification for Poly(Vinyl Chloride) (PVC) Plastic Pipe Fittings, Schedule 80	2.2.5.7.(2) A-2.2.5. to 2.2.8.
ASTM	D3138-21	Standard Specification for Solvent Cements for Transition Joints Between Acrylonitrile-Butadiene-Styrene (ABS) and Poly(Vinyl Chloride) (PVC) Non-Pressure Piping Components	A-2.2.5.9. to 2.2.5.11.
ASTM	D3261-16	Standard Specification for Butt Heat Fusion Polyethylene (PE) Plastic Fittings for Polyethylene (PE) Plastic Pipe and Tubing	2.2.5.4.(3)
ASTM	F628-22	Standard Specification for Acrylonitrile-Butadiene-Styrene (ABS) Schedule 40 Plastic Drain, Waste, and Vent Pipe With a Cellular Core	2.2.5.9.(1) 2.2.5.11.(1) A-2.2.5. to 2.2.8.
ASTM	F714-22	Standard Specification for Polyethylene (PE) Plastic Pipe (DR-PR) Based on Outside Diameter	2.2.5.5.(1) A-2.2.5. to 2.2.8.
ASTM	F3128-19	Standard Specification for Poly(Vinyl Chloride) (PVC) Schedule 40 Drain, Waste, and Vent Pipe with a Cellular Core	2.2.5.16.(1) A-2.2.5. to 2.2.8.
AWS	ANSI/AWS A5.8M/A5.8:2011	Specification for Filler Metals for Brazing and Braze Welding	2.2.9.2.(4)
AWWA	ANSI/AWWA C104/A21.4-13	Cement-Mortar Lining for Ductile-Iron Pipe and Fittings	2.2.6.4.(2)
AWWA	ANSI/AWWA C110/A21.10-12	Ductile-Iron and Gray-Iron Fittings	2.2.6.4.(3)
AWWA	ANSI/AWWA C111/A21.11-12	Rubber-Gasket Joints for Ductile-Iron Pressure Pipe and Fittings	2.2.6.4.(4)
AWWA	ANSI/AWWA C151/A21.51-09	Ductile-Iron Pipe, Centrifugally Cast	2.2.6.4.(1) A-2.2.5. to 2.2.8.
AWWA	ANSI/AWWA C228-08	Stainless-Steel Pipe Flanges for Water Service – Sizes 2 in. through 72 in. (50 mm through 1,800 mm)	2.2.6.12.(1)
AWWA	M14-2004	Recommended Practice for Backflow Prevention and Cross-Connection Control	A-2.6.2.4.(2)

**Table 1.3.1.2. (Continued)**

Issuing Agency	Document Number <sup>(2)</sup>	Title of Document	Code Reference
CCBFC	NRCC-CONST-56435E	National Building Code of Canada 2020	1.1.1.1.(3) <sup>(3)</sup> 1.4.1.2.(1) <sup>(3)</sup> 2.1.3.1.(1) 2.1.4.1.(1) 2.2.5.11.(2) 2.2.5.11.(3) 2.2.6.7.(3) 2.4.3.1.(1) 2.4.10.4.(1) A-2.2.1.1.(1) <sup>(3)</sup> A-2.2.5. to 2.2.8. A-2.4.10. A-2.4.10.4.(1) A-3.2.1.1.(1) <sup>(3)</sup>
CCBFC	NRCC-CONST-56438E	National Energy Code of Canada for Buildings 2020	A-2.2.1.1.(1) <sup>(3)</sup> A-3.2.1.1.(1) <sup>(3)</sup>
CCBFC	NRCC-CONST-56437E	National Fire Code of Canada 2020	2.5.5.2. A-2.2.1.1.(1) <sup>(3)</sup> A-3.2.1.1.(1) <sup>(3)</sup>
CSA	A60.1-M1976	Vitrified Clay Pipe	2.2.5.3.(1) A-2.2.5. to 2.2.8.
CSA	A60.3-M1976	Vitrified Clay Pipe Joints	2.2.5.3.(2)
CSA	A257.1:19	Non-reinforced circular concrete culvert, storm drain, sewer pipe, and fittings	2.2.5.2.(1) A-2.2.5. to 2.2.8.
CSA	A257.2:19	Reinforced circular concrete culvert, storm drain, sewer pipe, and fittings	2.2.5.2.(1) A-2.2.5. to 2.2.8.
CSA	A257.3:19	Joints for circular concrete sewer and culvert pipe, manhole sections, and fittings using rubber gaskets	2.2.5.2.(2)
CSA	A257.4:19	Precast reinforced circular concrete manhole sections, catch basins, and fittings	2.2.5.2.(5)
CSA	CAN/CSA-B45 Series-02	Plumbing Fixtures	2.2.2.2.(1)
CSA/IAPMO	CSA B45.5-17/IAPMO Z124-2017	Plastic plumbing fixtures	2.2.2.2.(1)
CSA	B64.0:21	Definitions, general requirements, and test methods for vacuum breakers and backflow preventers	2.2.10.10.(1)
CSA	B64.1.1:21	Atmospheric vacuum breakers (AVB)	2.2.10.10.(1)
CSA	B64.1.2:21	Pressure vacuum breakers (PVB)	2.2.10.10.(1)
CSA	B64.1.3:21	Spill-resistant pressure vacuum breakers (SRPVB)	2.2.10.10.(1)
CSA	B64.2:21	Hose connection vacuum breakers (HCVB)	2.2.10.10.(1)
CSA	B64.2.1:21	Hose connection vacuum breakers (HCVB) with manual draining feature	2.2.10.10.(1)
CSA	B64.2.2:21	Hose connection vacuum breakers (HCVB) with automatic draining feature	2.2.10.10.(1)
CSA	B64.3:21	Dual check valve backflow preventers with atmospheric port (DCAP)	2.2.10.10.(1)
CSA	B64.4:21	Reduced pressure principle (RP) backflow preventers	2.2.10.10.(1) 2.6.2.4.(2)
CSA	B64.4.1:21	Reduced pressure principle backflow preventers for fire protection systems (RPF)	2.2.10.10.(1) 2.6.2.4.(2) 2.6.2.4.(4) A-2.6.2.4.(2)
CSA	B64.5:21	Double check valve (DCVA) backflow preventers	2.2.10.10.(1) 2.6.2.4.(2)

Table 1.3.1.2. (Continued)

Issuing Agency	Document Number <sup>(2)</sup>	Title of Document	Code Reference
CSA	B64.5.1:21	Double check valve backflow preventers for fire protection systems (DCVAF)	2.2.10.10.(1) 2.6.2.4.(2) A-2.6.2.4.(2)
CSA	B64.6:21	Dual check valve (DuC) backflow preventers	2.2.10.10.(1) 2.6.2.4.(2)
CSA	B64.6.1:21	Dual check valve backflow preventers for fire protection systems (DuCF)	2.2.10.10.(1) 2.6.2.4.(2) A-2.6.2.4.(2)
CSA	B64.7:21	Laboratory faucet vacuum breakers (LFVB)	2.2.10.10.(1)
CSA	B64.8:21	Dual check valve backflow preventers with intermediate vent (DuCV)	2.2.10.10.(1)
CSA	B64.9:21	Single check valve backflow preventers for fire protection systems (SCVAF)	2.2.10.10.(1) 2.6.2.4.(2) A-2.6.2.4.(2)
CSA	B64.10-17	Selection and installation of backflow preventers	2.6.2.1.(3)
CSA	B70:19	Cast iron soil pipe, fittings, and means of joining	2.2.6.1.(1) 2.4.6.4.(5) A-2.2.5. to 2.2.8.
CSA	B70.1-03	Frames and Covers for Maintenance Holes and Catchbasins	2.2.6.2.(1)
CSA	B125.3-18	Plumbing fittings	2.2.10.6.(1) 2.2.10.7.(2) 2.2.10.7.(3) A-2.6.1.11.(1)
CSA	CAN/CSA-B126.0-13	General requirements and methods of testing for water cisterns	2.7.2.4.(6)
CSA	CAN/CSA-B126.1-13	Installation of water cisterns	2.7.2.4.(6)
CSA	CAN/CSA-B127.3:21	Fibrocement drain, waste, and vent pipe and pipe fittings	2.2.5.1.(1) A-2.2.5. to 2.2.8.
CSA	CAN/CSA-B128.1-06	Design and Installation of Non-Potable Water Systems	2.7.1.2.(1) A-2.7.1.1.(1)
CSA	B137.1:20	Polyethylene (PE) pipe, tubing, and fittings for cold-water pressure services	2.2.5.4.(1) A-2.2.5. to 2.2.8.
CSA	B137.2:20	Polyvinylchloride (PVC) injection-moulded gasketed fittings for pressure applications	2.2.5.7.(3) A-2.2.5. to 2.2.8.
CSA	B137.3:20	Rigid polyvinylchloride (PVC) pipe and fittings for pressure applications	2.2.5.7.(1) A-2.2.5. to 2.2.8.
CSA	B137.5:20	Crosslinked polyethylene (PEX) tubing systems for pressure applications	2.2.5.6.(1) A-2.2.5. to 2.2.8. A-2.2.5.6.(1)
CSA	B137.6:20	Chlorinated polyvinylchloride (CPVC) pipe, tubing, and fittings for hot- and cold-water distribution systems	2.2.5.8.(1) A-2.2.5. to 2.2.8. A-2.2.5.9. to 2.2.5.11.
CSA	B137.9:20	Polyethylene/aluminum/polyethylene (PE-AL-PE) composite pressure-pipe systems	2.2.5.12.(1) A-2.2.5. to 2.2.8. A-2.2.5.12.(1)
CSA	B137.10:20	Crosslinked polyethylene/aluminum/crosslinked polyethylene (PEX-AL-PEX) composite pressure-pipe systems	2.2.5.12.(4) 2.2.5.13.(1) A-2.2.5. to 2.2.8. A-2.2.5.13.(1)

**Table 1.3.1.2. (Continued)**

Issuing Agency	Document Number <sup>(2)</sup>	Title of Document	Code Reference
CSA	B137.11:20	Polypropylene (PP-R & PP-RCT) pipe and fittings for pressure applications	2.2.5.14.(1) A-2.2.5. to 2.2.8. A-2.2.5.14.(1)
CSA	B137.18:20	Polyethylene of raised temperature resistance (PE-RT) tubing systems for pressure applications	2.2.5.15.(1) A-2.2.5. to 2.2.8. A-2.2.5.15.(1)
CSA	B158.1-1976	Cast Brass Solder Joint Drainage, Waste and Vent Fittings	2.2.10.1.(1)
CSA	B181.1:21	Acrylonitrile-butadiene-styrene (ABS) drain, waste, and vent pipe and pipe fittings	2.2.5.9.(1) 2.2.5.10.(1) 2.2.5.11.(1) 2.4.6.4.(5) A-2.2.5. to 2.2.8. A-2.2.5.9. to 2.2.5.11.
CSA	B181.2:21	Polyvinylchloride (PVC) and chlorinated polyvinylchloride (CPVC) drain, waste, and vent pipe and pipe fittings	2.2.5.9.(1) 2.2.5.10.(1) 2.2.5.11.(1) 2.2.5.16.(1) 2.2.5.16.(2) 2.4.6.4.(5) A-2.2.5. to 2.2.8. A-2.2.5.9. to 2.2.5.11.
CSA	B181.3:21	Polyolefin and polyvinylidene fluoride (PVDF) laboratory drainage systems	2.2.8.1.(1) A-2.2.5. to 2.2.8.
CSA	CAN/CSA-B182.1:21	Plastic drain and sewer pipe and pipe fittings	2.2.5.9.(1) 2.4.6.4.(5) A-2.2.5. to 2.2.8.
CSA	CAN/CSA-B182.2:21	PSM type polyvinylchloride (PVC) sewer pipe and fittings	2.2.5.9.(1) A-2.2.5. to 2.2.8.
CSA	CAN/CSA-B182.4:21	Profile polyvinylchloride (PVC) sewer pipe and fittings	2.2.5.9.(1) A-2.2.5. to 2.2.8.
CSA	CAN/CSA-B182.6:21	Profile polyethylene (PE) sewer pipe and fittings for leak-proof sewer applications	2.2.5.9.(1) A-2.2.5. to 2.2.8.
CSA	CAN/CSA-B182.8:21	Profile polyethylene (PE) storm sewer and drainage pipe and fittings	2.2.5.9.(1)
CSA	B242-05	Groove- and Shoulder-Type Mechanical Pipe Couplings	2.2.10.4.(1)
CSA	B272-93	Prefabricated Self-Sealing Roof Vent Flashings	2.2.10.14.(2)
CSA	CAN/CSA-B356-10	Water pressure reducing valves for domestic water supply systems	2.2.10.12.(1)
CSA	B481.0-12	Material, design, and construction requirements for grease interceptors	2.2.3.2.(3)
CSA	B481.3-12	Sizing, selection, location, and installation of grease interceptors	2.2.3.2.(3)
CSA	B481.4-12	Maintenance of grease interceptors	A-2.2.3.2.(3)
CSA	CAN/CSA-B483.1:21	Drinking Water Treatment Systems	2.2.10.17.(1)
CSA	B602:20	Mechanical couplings for drain, waste, and vent pipe and sewer pipe	2.2.10.4.(2)
CSA/ICC	CSA B805-18/ICC 805-2018	Rainwater harvesting systems	2.7.2.4.(4) A-2.7.2.4.(1)
CSA	CAN/CSA-F379 SERIES-09 (excluding Supplement F379S1-11)	Packaged solar domestic hot water systems (liquid-to-liquid heat transfer)	2.2.10.13.(1)
CSA	CAN/CSA-F383-08	Installation of packaged solar domestic hot water systems	2.6.1.8.(1)



Table 1.3.1.2. (Continued)

Issuing Agency	Document Number <sup>(2)</sup>	Title of Document	Code Reference
CSA	CAN/CSA-G401-14	Corrugated steel pipe products	2.2.6.8.(1) A-2.2.5. to 2.2.8.
McGraw-Hill	2009	International Plumbing Codes Handbook	A-2.6.3.
NFPA	13D-2016	Standard for the Installation of Sprinkler Systems in One- and Two-Family Dwellings and Manufactured Homes	2.6.3.1.(3)
NIST	Building Materials and Structures Report BMS 79, 1941	Water-Distributing Systems for Buildings	A-2.6.3.
NSF	NSF Pro 151-8-1-95	Health Effects from Rainwater Catchment System Components	A-2.7.2.3.(2)
TIAC	2013	Mechanical Insulation Best Practices Guide	A-2.3.5.3.
ULC	CAN/ULC-S114:2018	Standard Method of Test for Determination of Non-Combustibility in Building Materials	1.4.1.2.(1) <sup>(3)</sup>

**Notes to Table 1.3.1.2.:**

- (1) While every effort was made to ensure the accuracy of the information in this Table, the NRC is not responsible for the accuracy, timeliness or reliability of the content presented therein. For all purposes of interpreting and applying the referenced standards, Code users should refer to the most recent official versions of the referenced editions.
- (2) Some documents may have been reaffirmed or reapproved. Check with the applicable issuing agency for up-to-date information.
- (3) Code reference is in Division A.

**1.3.2. Organizations****1.3.2.1. Abbreviations of Proper Names**

**1)** The abbreviations of proper names in this Code shall have the meanings assigned to them in this Article.

ANSI .....	American National Standards Institute ( <a href="http://www.ansi.org">www.ansi.org</a> )
ARCSEA .....	American Rainwater Catchment Systems Association ( <a href="http://www.arcsea.org">www.arcsea.org</a> )
ASHRAE .....	American Society of Heating, Refrigerating and Air-Conditioning Engineers ( <a href="http://www.ashrae.org">www.ashrae.org</a> )
ASME .....	American Society of Mechanical Engineers ( <a href="http://www.asme.org">www.asme.org</a> )
ASPE .....	American Society of Plumbing Engineers ( <a href="http://www.aspe.org">www.aspe.org</a> )
ASSE .....	American Society of Sanitary Engineering ( <a href="http://www.asse-plumbing.org">www.asse-plumbing.org</a> )
ASTM .....	ASTM International ( <a href="http://www.astm.org">www.astm.org</a> )
AWS .....	American Welding Society ( <a href="http://www.aws.org">www.aws.org</a> )
AWWA .....	American Water Works Association ( <a href="http://www.awwa.org">www.awwa.org</a> )
CAN .....	National Standard of Canada designation ( <a href="http://www.scc.ca">www.scc.ca</a> )
CBHCC .....	Canadian Board for Harmonized Construction Codes ( <a href="http://cbhcc-cchcc.ca">cbhcc-cchcc.ca</a> )
CCBFC .....	Canadian Commission on Building and Fire Codes (see NRC)
CSA .....	CSA Group ( <a href="http://www.csagroup.ca">www.csagroup.ca</a> )
IAPMO .....	International Association of Plumbing and Mechanical Officials ( <a href="http://www.iapmo.org">www.iapmo.org</a> )
ICC .....	International Code Council ( <a href="http://www.iccsafe.org">www.iccsafe.org</a> )
NBC .....	National Building Code of Canada 2020
NFC .....	National Fire Code of Canada 2020
NFPA .....	National Fire Protection Association ( <a href="http://www.nfpa.org">www.nfpa.org</a> )
NIST .....	National Institute of Standards and Technology ( <a href="http://www.nist.gov">www.nist.gov</a> )
NPC .....	National Plumbing Code of Canada 2020

- NRC ..... National Research Council of Canada ([nrc.canada.ca](http://nrc.canada.ca))
- NSF ..... National Sanitation Foundation International ([www.nsf.org](http://www.nsf.org))
- TIAC ..... Thermal Insulation Association of Canada ([www.tiac.ca](http://www.tiac.ca))
- ULC ..... ULC Standards ([canada.ul.com/ulcstandards](http://canada.ul.com/ulcstandards))



---

## **Division B**

# **Notes to Part 1 General**

**A-1.1.2.1.(1) Objectives and Functional Statements Attributed to Acceptable Solutions.** The objectives and functional statements attributed to each Code provision are shown in Table 2.8.1.1.

Many provisions in Division B serve as modifiers of or pointers to other provisions or serve other clarification or explanatory purposes. In most cases, no objectives and functional statements have been attributed to such provisions, which therefore do not appear in the above-mentioned table.

For provisions that serve as modifiers of or pointers to other referenced provisions and that do not have any objectives and functional statements attributed to them, the objectives and functional statements that should be used are those attributed to the provisions they reference.

---

These Notes are included for explanatory purposes only and do not form part of the requirements. The number that introduces each Note corresponds to the applicable requirement in this Part.



# Part 2

## Plumbing Systems

<b>2.1.</b>	<b>General</b>	
2.1.1.	Application .....	2-1
2.1.2.	Service Connections .....	2-1
2.1.3.	Location of Fixtures .....	2-1
2.1.4.	Seismic Design .....	2-2
<b>2.2.</b>	<b>Materials and Equipment</b>	
2.2.1.	General .....	2-2
2.2.2.	Fixtures .....	2-2
2.2.3.	Traps and Interceptors .....	2-3
2.2.4.	Pipe Fittings .....	2-4
2.2.5.	Non-Metallic Pipe and Fittings .....	2-4
2.2.6.	Ferrous Pipe and Fittings .....	2-8
2.2.7.	Non-Ferrous Pipe and Fittings .....	2-11
2.2.8.	Corrosion-Resistant Materials .....	2-12
2.2.9.	Joining Materials .....	2-12
2.2.10.	Miscellaneous Materials .....	2-13
<b>2.3.</b>	<b>Piping</b>	
2.3.1.	Application .....	2-16
2.3.2.	Construction and Use of Joints .....	2-16
2.3.3.	Joints and Connections .....	2-17
2.3.4.	Support of Piping .....	2-19
2.3.5.	Protection of Piping .....	2-21
2.3.6.	Testing of Drainage or Venting Systems .....	2-21
2.3.7.	Testing of Potable Water Systems .....	2-23
<b>2.4.</b>	<b>Drainage Systems</b>	
2.4.1.	Application .....	2-23
2.4.2.	Connections to Drainage Systems .....	2-23
2.4.3.	Location of Fixtures .....	2-25
2.4.4.	Treatment of Sewage and Waste ...	2-25
2.4.5.	Traps .....	2-26
2.4.6.	Arrangement of Drainage Piping ..	2-27
2.4.7.	Cleanouts .....	2-29
2.4.8.	Minimum Slope and Length of Drainage Pipes .....	2-30
2.4.9.	Size of Drainage Pipes .....	2-30
2.4.10.	Hydraulic Loads .....	2-33

<b>2.5.</b>	<b>Venting Systems</b>	
2.5.1.	Vent Pipes for Traps .....	2-37
2.5.2.	Wet Venting .....	2-38
2.5.3.	Circuit Venting .....	2-38
2.5.4.	Vent Pipes for Stacks .....	2-39
2.5.5.	Miscellaneous Vent Pipes .....	2-40
2.5.6.	Arrangement of Vent Pipes .....	2-41
2.5.7.	Minimum Size of Vent Pipes .....	2-42
2.5.8.	Sizing of Vent Pipes .....	2-44
2.5.9.	Air Admittance Valves .....	2-47
<b>2.6.</b>	<b>Potable Water Systems</b>	
2.6.1.	Arrangement of Piping .....	2-47
2.6.2.	Protection from Contamination ....	2-50
2.6.3.	Size and Capacity of Pipes .....	2-53
<b>2.7.</b>	<b>Non-Potable Water Systems</b>	
2.7.1.	Non-Potable Water Systems .....	2-57
2.7.2.	Non-Potable Rainwater Harvesting Systems .....	2-57
<b>2.8.</b>	<b>Objectives and Functional Statements</b>	
2.8.1.	Objectives and Functional Statements .....	2-59
	<b>Notes to Part 2 .....</b>	<b>2-71</b>

## Division B

# Part 2 Plumbing Systems

## Section 2.1. General

### 2.1.1. Application

#### 2.1.1.1. Application

1) This Part applies to all *plumbing systems* covered in this Code. (See Article 1.1.1.1. of Division A.)

### 2.1.2. Service Connections

#### 2.1.2.1. Sanitary Drainage Systems

1) Except where supplying systems that are covered in Section 2.7., *sanitary drainage systems* shall be connected to a public *sanitary sewer*, a public *combined sewer* or a *private sewage disposal system*.

2) A *combined building drain* shall not be installed. (See Note A-2.1.2.1.(2).)

#### 2.1.2.2. Storm Drainage Systems

1) Except as provided in Section 2.7., *storm drainage systems* shall be connected to a public *storm sewer*, a public *combined sewer* or a designated *storm water* disposal location.

#### 2.1.2.3. Water Distribution Systems

1) Except as provided in Section 2.7., *water distribution systems* shall be connected to a public water main or a *potable private water supply system*.

#### 2.1.2.4. Separate Services

1) Piping in any *building* connected to the public services shall be connected separately from piping of any other *building*, except that an ancillary *building* on the same property may be served by the same service. (See Note A-2.1.2.4.(1).)

### 2.1.3. Location of Fixtures

#### 2.1.3.1. Lighting and Ventilation Requirements

1) Plumbing *fixtures* shall not be installed in a room that is not lighted and ventilated in accordance with the appropriate requirements in Parts 3, 6 and 9 of Division B of the NBC.

#### 2.1.3.2. Accessibility

1) Every *fixture*, appliance, *interceptor*, *cleanout*, valve, device or piece of equipment shall be located so that it is readily accessible for use, cleaning and maintenance.



**2.1.4.1.****2.1.4. Seismic Design****2.1.4.1. Seismic Restraints and Design**

1) *Plumbing systems* in *buildings* constructed in accordance with Part 3 of Division B of the NBC shall be designed and installed to accommodate the seismic forces addressed in Subsection 4.1.8. of Division B of the NBC. (See Note A-2.1.4.1.(1).)

**Section 2.2. Materials and Equipment****2.2.1. General****2.2.1.1. Exposure of Materials**

1) Where unusual conditions exist, such as excessively corrosive soil or water, only materials suited for use in such locations shall be used.

2) Materials and equipment used in a *drainage system* where excessively corrosive wastes are present shall be suitable for the purpose.

**2.2.1.2. Restrictions on Re-Use**

1) Materials and equipment that have been used for a purpose other than the distribution of *potable* water shall not be subsequently used in a *potable water system*.

**2.2.1.3. Identification**

- 1) Every length of pipe and every fitting shall
  - a) have cast, stamped or indelibly marked on it the maker's name or mark and the weight or class or quality of the product, or
  - b) be marked in accordance with the relevant standard.
- 2) Markings required in Sentence (1) shall be visible after installation.

**2.2.1.4. Pipe or Piping**

1) Where the term pipe or piping is used, it shall also apply to tube or tubing unless otherwise stated.

**2.2.1.5. Withstanding Pressure**

1) Piping, fittings and joints used in pressure sewer, forcemain or sump pump discharge applications shall be capable of withstanding at least one and one-half times the maximum potential pressure.

**2.2.1.6. Working Pressure of a Water Service Pipe**

1) The working pressure rating of a *water service pipe* shall not be less than the maximum water main pressure at their point of connection as established by the water supply authority.

**2.2.2. Fixtures****2.2.2.1. Surface Requirements**

1) Every *fixture* shall have a smooth, hard, corrosion-resistant surface free of flaws and blemishes that may interfere with cleaning.

**2.2.2.2. Conformance to Standards**

- 1) Except as provided in Article 2.2.2.3.,
  - a) *fixtures* shall conform to CAN/CSA-B45 Series, "Plumbing Fixtures,"
  - b) vitreous china *fixtures* shall conform to ASME A112.19.2/CSA B45.1, "Ceramic Plumbing Fixtures,"

- c) enamelled cast-iron *fixtures* shall conform to ASME A112.19.1/CSA B45.2, "Enamelled Cast Iron and Enamelled Steel Plumbing Fixtures,"
- d) porcelain-enamelled steel *fixtures* shall conform to ASME A112.19.1/CSA B45.2, "Enamelled Cast Iron and Enamelled Steel Plumbing Fixtures,"
- e) stainless steel *fixtures* shall conform to ASME A112.19.3/CSA B45.4, "Stainless Steel Plumbing Fixtures,"
- f) plastic *fixtures* shall conform to CSA B45.5/IAPMO Z124, "Plastic plumbing fixtures,"
- g) hydromassage bathtubs shall conform to ASME A112.19.7/CSA B45.10, "Hydromassage bathtub systems,"
- h) macerating toilet systems shall conform to ASME A112.3.4/CSA B45.9, "Macerating Toilet Systems and Waste-Pumping Systems for Plumbing Fixtures," and
- i) personal hygiene devices for water closets shall conform to ASME A112.4.2/CSA B45.16, "Personal hygiene devices for water closets."

### 2.2.2.3. Showers

- 1) Shower receptors shall be constructed and arranged so that water cannot leak through the walls or floor.
- 2) Not more than 6 shower heads shall be served by a single shower drain.
- 3) Where 2 or more shower heads are served by a shower drain, the floor shall be sloped and the drain located so that water from one head cannot flow over the area that serves another head. (See Note A-2.2.2.3.(3).)
- 4) Except for column showers, where a battery of shower heads is installed, the horizontal distance between 2 adjacent shower heads shall be not less than 750 mm.

### 2.2.2.4. Concealed Overflows

- 1) A dishwashing sink and a food preparation sink shall not have concealed overflows. (See Note A-2.2.2.4.(1).)

### 2.2.2.5. Water Closets in Public Washrooms

- 1) Where a water closet is installed in a washroom for *public use*, it shall be of the elongated type and provided with a seat of the open front type.

## 2.2.3. Traps and Interceptors

### 2.2.3.1. Traps

- 1) Except as provided for in Sentence (2), *traps* shall
  - a) have a *trap seal depth* of not less than 38 mm,
  - b) be so designed that failure of the seal walls will cause exterior leakage, and
  - c) have a water seal that does not depend on the action of moving parts.
 (See Note A-2.2.3.1.(1) and (3).)
- 2) The *trap seal depth* on *fixtures* draining to an acid waste system shall be a minimum of 50 mm.
- 3) Except for a floor-mounted service sink, every *trap* that serves a lavatory, a sink or a laundry tray shall
  - a) be provided with a *cleanout* plug located at the lowest point of the *trap* and of the same material as the *trap*, except that a cast-iron *trap* shall be provided with a brass *cleanout* plug, or
  - b) be designed so that part of the *trap* can be removed for cleaning purposes.
 (See Note A-2.2.3.1.(1) and (3).)
- 4) A bell *trap* shall not be installed in a *drainage system*. (See Note A-2.2.3.1.(4).)
- 5) A drum *trap* shall not be used as a *fixture trap* unless required to serve as an *interceptor* and access for servicing is provided.

**2.2.3.2.****2.2.3.2. Interceptors**

- 1) *Interceptors* shall be designed so that they can be readily cleaned.
  - 2) Grease *interceptors* shall
    - a) be designed so that they do not become air bound, and
    - b) not have a water jacket.
  - 3) Grease *interceptors* shall be selected and installed in conformance with
    - a) CSA B481.0, "Material, design, and construction requirements for grease interceptors," and
    - b) CSA B481.3, "Sizing, selection, location, and installation of grease interceptors."
- (See Note A-2.2.3.2.(3).)

**2.2.3.3. Tubular Traps**

- 1) Tubular metal or plastic *traps* conforming to ASME A112.18.2/CSA B125.2, "Plumbing Waste Fittings," shall be used only in accessible locations.

**2.2.4. Pipe Fittings****2.2.4.1. T and Cross Fittings**

(See Note A-2.2.4.1.)

- 1) A T fitting shall not be used in a *drainage system*, except to connect a *vent pipe*.
- 2) A cross fitting shall not be used in a *drainage system*.

**2.2.4.2. Sanitary T Fittings**

(See Note A-2.2.4.2.)

- 1) A single or double sanitary T fitting shall not be used in a *nominally horizontal sanitary drainage pipe*, except that a single sanitary T fitting may be used to connect a *vent pipe*.
- 2) A double sanitary T fitting shall not be used to connect the *trap arms* of
  - a) back outlet water closets installed back-to-back, or
  - b) 2 urinals where no *cleanout* fitting is provided above the connection.

**2.2.4.3. 90° Elbows**

- 1) Except as permitted in Sentence (2), 90° elbows of NPS 4 or less whose centre-line radius is less than the NPS of the pipe shall not be used to join 2 *sanitary drainage pipes*.
- 2) For *sanitary drainage systems* of NPS 4 or less, 90° elbows described in Sentence (1) shall only be permitted
  - a) to change the direction of piping from horizontal to vertical, in the direction of flow,
  - b) where a *trap arm* enters a wall, or
  - c) to connect *trap arms* as permitted by Sentence 2.5.6.3.(2).

**2.2.5. Non-Metallic Pipe and Fittings**

(For a summary of pipe applications, see Note A-2.2.5. to 2.2.8.)

**2.2.5.1. Fibrocement Pipe and Fittings**

- 1) Fibrocement pipe and fittings for use in a drain, waste or vent system shall conform to CAN/CSA-B127.3, "Fibrocement drain, waste, and vent pipe and pipe fittings."

**2.2.5.2. Concrete Pipe and Fittings**

- 1) Concrete pipe shall conform to
  - a) CSA A257.1, "Non-reinforced circular concrete culvert, storm drain, sewer pipe, and fittings," or
  - b) CSA A257.2, "Reinforced circular concrete culvert, storm drain, sewer pipe, and fittings."

2) Joints with internal elastomeric gaskets shall conform to CSA A257.3, "Joints for circular concrete sewer and culvert pipe, manhole sections, and fittings using rubber gaskets."

3) Concrete fittings fabricated on the site from lengths of pipe shall not be used. (See Note A-2.2.5.2.(3).)

4) Concrete pipe shall not be used above ground inside a *building*.

5) Precast reinforced circular concrete manhole sections, catch basins and fittings shall conform to CSA A257.4, "Precast reinforced circular concrete manhole sections, catch basins, and fittings."

**2.2.5.3. Vitrified Clay Pipe and Fittings**

1) Vitrified clay pipe and fittings shall conform to CSA A60.1-M, "Vitrified Clay Pipe."

2) Couplings and joints for vitrified clay pipe shall conform to CSA A60.3-M, "Vitrified Clay Pipe Joints."

3) Vitrified clay pipe and fittings shall not be used except for an underground part of a *drainage system*.

**2.2.5.4. Polyethylene Pipe and Fittings**

1) Polyethylene water pipe, tubing and fittings shall conform to Series 160 of CSA B137.1, "Polyethylene (PE) pipe, tubing, and fittings for cold-water pressure services."

2) Polyethylene water pipe shall not be used except for a *water service pipe*.

3) Butt fusion fittings for polyethylene pipe shall conform to ASTM D3261, "Standard Specification for Butt Heat Fusion Polyethylene (PE) Plastic Fittings for Polyethylene (PE) Plastic Pipe and Tubing."

**2.2.5.5. Polyethylene Pipe Used Underground**

1) Polyethylene pipe used underground outside a *building* for the rehabilitation of existing *drainage systems* using trenchless technology shall conform to ASTM F714, "Standard Specification for Polyethylene (PE) Plastic Pipe (DR-PR) Based on Outside Diameter," and shall be HDPE 3408 and SDR 11 or heavier. (See Note A-2.2.5.5.(1).)

**2.2.5.6. Crosslinked Polyethylene Pipe and Fittings**

1) Crosslinked polyethylene pipe and manufacturer-approved fittings used in hot and cold *potable water systems* shall conform to CSA B137.5, "Crosslinked polyethylene (PEX) tubing systems for pressure applications." (See Note A-2.2.5.6.(1).)

**2.2.5.7. PVC Pipe and Fittings**

- 1) PVC water pipe, fittings and solvent cement shall
  - a) conform to CSA B137.3, "Rigid polyvinylchloride (PVC) pipe and fittings for pressure applications," and
  - b) have a pressure rating of not less than 1 100 kPa.

- 2) PVC water pipe fittings shall conform to
  - a) ASTM D2466, "Standard Specification for Poly(Vinyl Chloride) (PVC) Plastic Pipe Fittings, Schedule 40," or
  - b) ASTM D2467, "Standard Specification for Poly(Vinyl Chloride) (PVC) Plastic Pipe Fittings, Schedule 80."

3) PVC injection-moulded gasketed fittings shall conform to CSA B137.2, "Polyvinylchloride (PVC) injection-moulded gasketed fittings for pressure applications."

4) PVC water pipe and fittings referred to in Sentences (1), (2) and (3) shall not be used in a hot *water system*.

### 2.2.5.8. CPVC Pipe, Fittings and Solvent Cements

1) CPVC hot and cold water pipe, fittings and solvent cements shall conform to CSA B137.6, "Chlorinated polyvinylchloride (CPVC) pipe, tubing, and fittings for hot- and cold-water distribution systems."

2) The design temperature and design pressure of a CPVC piping system shall conform to Table 2.2.5.8.

**Table 2.2.5.8.**  
**Maximum Permitted Pressure for CPVC Piping at Various Temperatures**  
Forming Part of Sentence 2.2.5.8.(2)

Maximum Temperature of Water, °C	Maximum Permitted Pressures, kPa
10	3 150
20	2 900
30	2 500
40	2 100
50	1 700
60	1 300
70	1 000
82	690

### 2.2.5.9. Plastic Pipe, Fittings and Solvent Cement Used Underground

(See Note A-2.2.5.9. to 2.2.5.11.)

1) Plastic pipe, fittings and solvent cement used underground outside a *building* or under a *building* in a *drainage system* shall conform to

- a) ASTM F628, "Standard Specification for Acrylonitrile-Butadiene-Styrene (ABS) Schedule 40 Plastic Drain, Waste, and Vent Pipe With a Cellular Core,"
- b) CSA B181.1, "Acrylonitrile-butadiene-styrene (ABS) drain, waste, and vent pipe and pipe fittings,"
- c) CSA B181.2, "Polyvinylchloride (PVC) and chlorinated polyvinylchloride (CPVC) drain, waste, and vent pipe and pipe fittings,"
- d) CAN/CSA-B182.1, "Plastic drain and sewer pipe and pipe fittings," with a pipe stiffness not less than 320 kPa,
- e) CAN/CSA-B182.2, "PSM type polyvinylchloride (PVC) sewer pipe and fittings," with a pipe stiffness not less than 320 kPa,
- f) CAN/CSA-B182.4, "Profile polyvinylchloride (PVC) sewer pipe and fittings," with a pipe stiffness not less than 320 kPa,
- g) CAN/CSA-B182.6, "Profile polyethylene (PE) sewer pipe and fittings for leak-proof sewer applications," with a pipe stiffness not less than 320 kPa, or
- h) CAN/CSA-B182.8, "Profile polyethylene (PE) storm sewer and drainage pipe and fittings," for Type 1 joints and non-perforated pipes.

### 2.2.5.10. Transition Solvent Cement

(See Note A-2.2.5.9. to 2.2.5.11.)

- 1) Solvent cement for transition joints shall conform to
  - a) CSA B181.1, "Acrylonitrile-butadiene-styrene (ABS) drain, waste, and vent pipe and pipe fittings," or
  - b) CSA B181.2, "Polyvinylchloride (PVC) and chlorinated polyvinylchloride (CPVC) drain, waste, and vent pipe and pipe fittings."

2) Transition solvent cement shall only be used for joining an ABS *drainage system* to a PVC *drainage system*.

#### 2.2.5.11. Plastic Pipe, Fittings and Solvent Cement Used in Buildings

(See Note A-2.2.5.9. to 2.2.5.11.)

1) Plastic pipe, fittings and solvent cement used inside or under a *building* in a *drainage* or *venting system* shall conform to

- a) ASTM F628, "Standard Specification for Acrylonitrile-Butadiene-Styrene (ABS) Schedule 40 Plastic Drain, Waste, and Vent Pipe With a Cellular Core,"
- b) CSA B181.1, "Acrylonitrile-butadiene-styrene (ABS) drain, waste, and vent pipe and pipe fittings," or
- c) CSA B181.2, "Polyvinylchloride (PVC) and chlorinated polyvinylchloride (CPVC) drain, waste, and vent pipe and pipe fittings."

2) Requirements for *combustible* piping in relation to fire safety shall conform to Sentences 3.1.5.19.(1) and 9.10.9.8.(3), (5) and (6), and Articles 3.1.9.4., 9.10.9.7. and 9.10.9.9. of Division B of the NBC.

3) Where *noncombustible* piping pierces a *fire separation* or a firestop, the requirements for firestopping of Subsection 3.1.9., Sentence 9.10.9.6.(1) and Article 9.10.16.4. of Division B of the NBC shall apply.

#### 2.2.5.12. Polyethylene/Aluminum/Polyethylene Composite Pipe and Fittings

1) PE/AL/PE composite pipe and fittings shall conform to CSA B137.9, "Polyethylene/aluminum/polyethylene (PE-AL-PE) composite pressure-pipe systems." (See Note A-2.2.5.12.(1).)

2) Except as provided in Sentences (3) and (4), PE/AL/PE pipe and fittings shall not be used in hot *water systems*.

3) PE/AL/PE pipe with a pressure rating of 690 kPa or greater at 82°C shall be permitted for hot *water systems*.

4) PE/AL/PE pipe with a pressure rating of 690 kPa or greater at 82°C shall be used with fittings that conform to CSA B137.10, "Crosslinked polyethylene/aluminum/crosslinked polyethylene (PEX-AL-PEX) composite pressure-pipe systems," in hot *water systems*.

#### 2.2.5.13. Crosslinked Polyethylene/Aluminum/Crosslinked Polyethylene Composite Pressure Pipe and Fittings

1) PEX/AL/PEX composite pipe and fittings used in hot and cold *potable water systems* shall conform to CSA B137.10, "Crosslinked polyethylene/aluminum/crosslinked polyethylene (PEX-AL-PEX) composite pressure-pipe systems." (See Note A-2.2.5.13.(1).)

#### 2.2.5.14. Polypropylene Pipe and Fittings

1) Polypropylene pipe and fittings used for hot and cold *potable water systems* shall conform to CSA B137.11, "Polypropylene (PP-R & PP-RCT) pipe and fittings for pressure applications." (See Note A-2.2.5.14.(1).)

#### 2.2.5.15. Polyethylene of Raised Temperature Tube and Fittings

1) Polyethylene of raised temperature (PE-RT) tube and manufacturer-approved fittings used in hot and cold *potable water systems* shall conform to CSA B137.18, "Polyethylene of raised temperature resistance (PE-RT) tubing systems for pressure applications." (See Note A-2.2.5.15.(1).)

2) The use of PE-RT tube shall conform to Table 2.2.5.15.

**Table 2.2.5.15.**  
**Permitted Uses of Polyethylene of Raised Temperature (PE-RT) Tube**  
 Forming Part of Sentence 2.2.5.15.(2)

Type of Tube	Plumbing Purposes <sup>(1)</sup>								
	Drainage System		Building Sewer	Venting System		Potable Water System			
	Aboveground inside building	Underground under building		Above-ground	Under-ground	Cold	Hot	Under building	Outside building
PE-RT	N	N	N	N	N	P	P	P	P

**Notes to Table 2.2.5.15.:**

<sup>(1)</sup> P = permitted and N = not permitted.

**2.2.5.16. Cellular Core PVC Pipe and Fittings**

- 1)** Cellular core PVC pipe shall
  - a) conform to ASTM F3128, "Standard Specification for Poly(Vinyl Chloride) (PVC) Schedule 40 Drain, Waste, and Vent Pipe with a Cellular Core," and
  - b) be light grey, as specified in CSA B181.2, "Polyvinylchloride (PVC) and chlorinated polyvinylchloride (CPVC) drain, waste, and vent pipe and pipe fittings."
- 2)** Fittings and solvent cements for cellular core PVC pipe shall conform to CSA B181.2, "Polyvinylchloride (PVC) and chlorinated polyvinylchloride (CPVC) drain, waste, and vent pipe and pipe fittings."
- 3)** Cellular core PVC pipe shall only be used in residential *buildings* containing 1 or 2 *dwelling units* and in row houses that do not exceed 3 *storeys* in height.

**2.2.6. Ferrous Pipe and Fittings**

(For a summary of pipe applications, see Note A-2.2.5. to 2.2.8.)

**2.2.6.1. Cast-Iron Drainage and Vent Pipe and Fittings**

- 1)** Drainage piping, vent piping and fittings made of cast iron shall conform to CSA B70, "Cast iron soil pipe, fittings, and means of joining."
- 2)** Cast-iron soil pipe and fittings shall not be used in a *water system*.

**2.2.6.2. Maintenance Holes and Catch Basins**

- 1)** Cast-iron frames and covers for maintenance holes and catch basins shall conform to CSA B70.1, "Frames and Covers for Maintenance Holes and Catchbasins."

**2.2.6.3. Threaded Cast-Iron Drainage Fittings**

- 1)** Threaded cast-iron drainage fittings shall conform to ASME B16.12, "Cast Iron Threaded Drainage Fittings."
- 2)** Threaded cast-iron drainage fittings shall not be used in a *water system*.

**2.2.6.4. Cast-Iron Water Pipes**

- 1)** Cast-iron water pipes shall conform to ANSI/AWWA C151/A21.51, "Ductile-Iron Pipe, Centrifugally Cast."
- 2)** Cement mortar lining for cast-iron water pipes shall conform to ANSI/AWWA C104/A21.4, "Cement-Mortar Lining for Ductile-Iron Pipe and Fittings."
- 3)** Cast-iron fittings for cast-iron or ductile-iron water pipes shall conform to ANSI/AWWA C110/A21.10, "Ductile-Iron and Gray-Iron Fittings."
- 4)** Rubber gasket joints for cast-iron and ductile-iron pressure pipe for water shall conform to ANSI/AWWA C111/A21.11, "Rubber-Gasket Joints for Ductile-Iron Pressure Pipe and Fittings."

**2.2.6.5. Screwed Cast-Iron Water Fittings**

- 1) Screwed cast-iron water fittings shall conform to ASME B16.4, "Gray Iron Threaded Fittings: Classes 125 and 250."
- 2) Screwed cast-iron water fittings used in a *water system* shall be cement-mortar lined or galvanized.
- 3) Screwed cast-iron water fittings shall not be used in a *drainage system*.

**2.2.6.6. Screwed Malleable-Iron Water Fittings**

- 1) Screwed malleable-iron water fittings shall conform to ASME B16.3, "Malleable Iron Threaded Fittings: Classes 150 and 300."
- 2) Screwed malleable-iron water fittings used in a *water system* shall be cement-mortar lined or galvanized.
- 3) Screwed malleable-iron water fittings shall not be used in a *drainage system*.

**2.2.6.7. Steel Pipe**

- 1) Except as provided in Sentences (2) and (3), welded and seamless steel pipe shall not be used in a *plumbing system*.
- 2) Galvanized steel pipe is permitted to be used in a *drainage system* or a *venting system* above ground inside a *building*.
- 3) Galvanized steel pipe and fittings shall not be used in a *water distribution system* except
  - a) in *buildings* of industrial *occupancy* as described in the NBC, or
  - b) for the repair of existing galvanized steel piping systems.(See Note A-2.2.6.7.(3).)
- 4) Galvanized steel pipe and fittings shall conform to ASTM A53/A53M, "Standard Specification for Pipe, Steel, Black and Hot-Dipped, Zinc-Coated, Welded and Seamless."

**2.2.6.8. Corrugated Steel Pipe and Couplings**

- 1) Corrugated steel pipe and couplings shall conform to CAN/CSA-G401, "Corrugated steel pipe products."
- 2) Corrugated steel pipe shall only be used underground outside a *building* in a *storm drainage system*.
- 3) Couplings for corrugated steel pipe shall be constructed so that when installed they shall
  - a) maintain the pipe alignment,
  - b) resist the separation of adjoining lengths of pipe,
  - c) prevent root penetration, and
  - d) prevent the infiltration of surrounding material.

**2.2.6.9. Sheet Metal Leaders**

- 1) A sheet metal *leader* shall not be used except above ground outside a *building*.

**2.2.6.10. Stainless Steel Pipe**

- 1) Stainless steel pipe shall conform to
  - a) ASME B36.19M, "Stainless Steel Pipe," and
  - b) ASTM A312/A312M, "Standard Specification for Seamless, Welded, and Heavily Cold Worked Austenitic Stainless Steel Pipes."
- 2) Only grade 304/304L or 316/316L stainless steel pipe shall be used.



**2.2.6.11. Stainless Steel Butt Weld Pipe Fittings**

- 1) Stainless steel butt weld pipe fittings shall conform to
  - a) ASME B16.9, "Factory-Made Wrought Butt Welding Fittings," and
  - b) ASTM A403/A403M, "Standard Specification for Wrought Austenitic Stainless Steel Piping Fittings."
- 2) Stainless steel butt weld pipe fittings shall be made of a material that matches the grade of the pipe material used.

**2.2.6.12. Stainless Steel Pipe Flanges**

- 1) Stainless steel pipe flanges shall conform to ASME B16.5, "Pipe Flanges and Flanged Fittings: NPS ½ through NPS 24 Metric/Inch Standard," and
  - a) ASTM A182/A182M, "Standard Specification for Forged or Rolled Alloy and Stainless Steel Pipe Flanges, Forged Fittings, and Valves and Parts for High-Temperature Service," or
  - b) ANSI/AWWA C228, "Stainless-Steel Pipe Flanges for Water Service – Sizes 2 in. through 72 in. (50 mm through 1,800 mm)."
- 2) Stainless steel pipe flanges shall be made of a material that matches the grade of the pipe material used.

**2.2.6.13. Stainless Steel Threaded Fittings**

- 1) Stainless steel threaded fittings shall be schedule 40s or greater conforming to
  - a) ASTM A182/A182M, "Standard Specification for Forged or Rolled Alloy and Stainless Steel Pipe Flanges, Forged Fittings, and Valves and Parts for High-Temperature Service," or
  - b) ASTM A351/A351M, "Standard Specification for Castings, Austenitic, for Pressure-Containing Parts."
- 2) Stainless steel threaded fittings shall be made of a material that matches the grade of the pipe material used.

**2.2.6.14. Stainless Steel Tube**

- 1) Stainless steel tube shall conform to
  - a) ASME B16.9, "Factory-Made Wrought Butt Welding Fittings," and
  - b) ASTM A269/A269M, "Standard Specification for Seamless and Welded Austenitic Stainless Steel Tubing for General Service."
- 2) Only grade 304/304L or 316/316L stainless steel tube shall be used.

**2.2.6.15. Stainless Steel Pipe and Tube**

- 1) The use of stainless steel pipe and tube shall conform to Table 2.2.6.15.

**Table 2.2.6.15.**  
**Permitted Uses of Stainless Steel Pipe and Tube**  
 Forming Part of Sentence 2.2.6.15.(1)

Stainless Steel Pipe or Tube	Plumbing Purposes <sup>(1)</sup>						
	Water Distribution System		Building Sewer	Drainage System		Venting System	
	Underground	Aboveground		Underground	Aboveground	Underground	Aboveground
Stainless steel pipe	P	P	P	P	P	P	P
Stainless steel tube	P	P	N	N	N	N	N

**Notes to Table 2.2.6.15.:**

(1) P = permitted and N = not permitted.

**2.2.7. Non-Ferrous Pipe and Fittings**

(For a summary of pipe applications, see Note A-2.2.5. to 2.2.8.)

**2.2.7.1. Copper and Brass Pipe**

- 1) Copper pipe shall conform to
  - a) ASTM B42, "Standard Specification for Seamless Copper Pipe, Standard Sizes," and
  - b) Table 2.2.7.4.
- 2) Brass pipe shall conform to ASTM B43, "Standard Specification for Seamless Red Brass Pipe, Standard Sizes."

**2.2.7.2. Brass or Bronze Pipe Flanges and Flanged Fittings**

- 1) Brass or bronze pipe flanges and flanged fittings shall conform to ASME B16.24, "Cast Copper Alloy Pipe Flanges, Flanged Fittings, and Valves: Classes 150, 300, 600, 900, 1500, and 2500."

**2.2.7.3. Brass or Bronze Threaded Water Fittings**

- 1) Brass or bronze threaded water fittings shall conform to ASME B16.15, "Cast Copper Alloy Threaded Fittings: Classes 125 and 250."
- 2) Brass or bronze threaded water fittings shall not be used in a *drainage system*.

**2.2.7.4. Copper Tube**

- 1) Copper tube shall conform to
  - a) ASTM B88, "Standard Specification for Seamless Copper Water Tube," or
  - b) ASTM B306, "Standard Specification for Copper Drainage Tube (DWV)."
- 2) Except as provided in Sentence (3), the use of copper tube shall conform to Table 2.2.7.4.
- 3) Copper tube shall not be used for the *fixture drain* or the portion of the *vent pipe* below the *flood level rim* of a urinal.

**Table 2.2.7.4.**  
**Permitted Use of Copper Tube and Pipe**  
 Forming Part of Sentences 2.2.7.1.(1) and 2.2.7.4.(2)

Type of Copper Tube or Pipe	Plumbing Purposes <sup>(1)</sup>							
	Water Service Pipe	Water Distribution System		Building Sewer	Drainage System		Venting System	
		Under-ground	Above-ground		Under-ground	Above-ground	Under-ground	Above-ground
K & L hard temper	N	N	P	P	P	P	P	P
K & L soft temper	P	P	P	N	N	N	N	N
M hard temper	N	N	P	N	N	P	N	P
M soft temper	N	N	N	N	N	N	N	N
DWV	N	N	N	N	N	P	N	P

**Notes to Table 2.2.7.4.:**

(1) P = permitted and N = not permitted.

**2.2.7.5. Solder-Joint Drainage Fittings**

- 1) Solder-joint fittings for *drainage systems* shall conform to
  - a) ASME B16.23, "Cast Copper Alloy Solder Joint Drainage Fittings: DWV," or
  - b) ASME B16.29, "Wrought Copper and Wrought Copper Alloy Solder-Joint Drainage Fittings – DWV."
- 2) Solder-joint fittings for *drainage systems* shall not be used in a *water system*.

**2.2.7.6.****2.2.7.6. Solder-Joint Water Fittings**

**1)** Except as provided in Sentence (2), solder-joint fittings for *water systems* shall conform to

- a) ASME B16.18, "Cast Copper Alloy Solder Joint Pressure Fittings," or
- b) ASME B16.22, "Wrought Copper and Copper Alloy Solder-Joint Pressure Fittings."

**2)** Solder-joint fittings for *water systems* not made by casting or the wrought process shall conform to the applicable requirements of ASME B16.18, "Cast Copper Alloy Solder Joint Pressure Fittings."

**2.2.7.7. Flared-Joint Fittings for Copper Water Systems**

**1)** Flared-joint fittings for copper tube *water systems* shall conform to ASME B16.26, "Cast Copper Alloy Fittings for Flared Copper Tubes."

**2)** Flared-joint fittings for copper tube *water systems* not made by casting shall conform to the applicable requirements of ASME B16.26, "Cast Copper Alloy Fittings for Flared Copper Tubes."

**2.2.7.8. Lead Waste Pipe and Fittings**

**1)** Lead waste pipe and fittings shall not be used in a *water system* or as a *building sewer*.

**2)** When there is a change in *nominal pipe size* of a lead water closet bend, the change shall be in the vertical section of the bend or made in a manner that prevents the retention of liquid in the bend.

**2.2.8. Corrosion-Resistant Materials**

(For a summary of pipe applications, see Note A-2.2.5. to 2.2.8.)

**2.2.8.1. Pipes and Fittings**

**1)** Pipes and fittings to be used for drainage and venting of acid and corrosive wastes shall conform to

- a) ASTM A518/A518M, "Standard Specification for Corrosion-Resistant High-Silicon Iron Castings,"
- b) ASTM C1053, "Standard Specification for Borosilicate Glass Pipe and Fittings for Drain, Waste, and Vent (DWV) Applications," or
- c) CSA B181.3, "Polyolefin and polyvinylidene fluoride (PVDF) laboratory drainage systems."

**2.2.9. Jointing Materials****2.2.9.1. Cement Mortar**

**1)** Cement mortar shall not be used for jointing.

**2.2.9.2. Solders and Fluxes**

**1)** Solders for solder joint fittings shall conform to ASTM B32, "Standard Specification for Solder Metal."

**2)** Solders and fluxes having a lead content in excess of 0.2% shall not be used in a *potable water system*.

**3)** Fluxes for soldered joints shall conform to ASTM B813, "Standard Specification for Liquid and Paste Fluxes for Soldering of Copper and Copper Alloy Tube."

**4)** Brazing alloys shall conform to ANSI/AWS A5.8M/A5.8, "Specification for Filler Metals for Brazing and Braze Welding," BCuP range.

**2.2.10. Miscellaneous Materials**

**2.2.10.1. Brass Floor Flanges**

1) Brass floor flanges shall conform to CSA B158.1, "Cast Brass Solder Joint Drainage, Waste and Vent Fittings."

**2.2.10.2. Screws, Bolts, Nuts and Washers**

- 1) Every screw, bolt, nut and washer shall be of corrosion-resistant materials when used
- a) to connect a water closet to a floor flange,
  - b) to anchor the floor flange to the floor, or
  - c) to anchor the water closet to the floor.

**2.2.10.3. Cleanout Fittings**

- 1) Every plug, cap, nut or bolt that is intended to be removable from a ferrous fitting shall be of a non-ferrous material.
- 2) A *cleanout* fitting that, as a result of normal maintenance operations, cannot withstand the physical stresses of removal and reinstallation or cannot ensure a gas-tight seal shall not be installed.

**2.2.10.4. Mechanical Couplings**

- 1) Groove- and shoulder-type mechanical couplings for pressure applications shall conform to CSA B242, "Groove- and Shoulder-Type Mechanical Pipe Couplings."
- 2) Mechanical couplings for non-pressure applications shall conform to CSA B602, "Mechanical couplings for drain, waste, and vent pipe and sewer pipe."

**2.2.10.5. Saddle Hubs**

1) A saddle hub or fitting shall not be installed in *drainage, venting* or *water systems*. (See Note A-2.2.10.5.(1).)

**2.2.10.6. Valves, and Supply and Waste Fittings**

- 1) Supply fittings shall conform to
- a) ASME A112.18.1/CSA B125.1, "Plumbing Supply Fittings," or
  - b) CSA B125.3, "Plumbing fittings."
- 2) Except for lavatories in healthcare facilities, emergency eye washes, and emergency showers, supply fittings and individual shower heads shall have an integral means of limiting the maximum water flow rate to that specified in Table 2.2.10.6. (See Note A-2.2.10.6.(2).)

**Table 2.2.10.6.**  
**Water Flow Rates from Supply Fittings**  
 Forming Part of Sentence 2.2.10.6.(2)

Supply Fittings	Maximum Water Flow Rate, L/min
Lavatory supply fittings	
private	5.7
public	1.9
Kitchen supply fittings (except those in industrial, commercial or institutional kitchens)	8.3
Shower heads	7.6

3) An automatic compensating valve serving an individual shower head addressed in Sentence (1) shall have a water flow rate equal to or less than the shower head it serves. (See Note A-2.2.10.6.(3).)

**4)** Where multiple shower heads installed in a public showering facility are served by one temperature control, each shower head shall be equipped with a device capable of automatically shutting off the flow of water when the shower head is not in use. (See Note A-2.2.10.6.(4) and (5).)

**5)** Each lavatory in a public washroom shall be equipped with a device capable of automatically shutting off the flow of water when the lavatory is not in use. (See Note A-2.2.10.6.(4) and (5).)

**6)** Waste fittings shall conform to ASME A112.18.2/CSA B125.2, "Plumbing Waste Fittings."

**7)** Manually operated valves of *NPS* 4 or less for use in *plumbing systems* shall conform to ASME A112.4.14/CSA B125.14, "Manually Operated Valves for Use in Plumbing Systems." (See Note A-2.2.10.6.(7).)

### 2.2.10.7. Water Temperature Control

(See Note A-2.2.10.7.)

**1)** Except as provided in Sentences (2) and (3), water supplied to shower heads or bathtubs shall be controlled by an automatic compensating valve conforming to

- a) ASME A112.18.1/CSA B125.1, "Plumbing Supply Fittings," or
- b) ASSE 1016/ASME A112.1016/CSA B125.16, "Performance Requirements for Automatic Compensating Valves for Individual Showers and Tub/Shower Combinations."

**2)** The requirement in Sentence (1) is permitted to be waived where hot water supplied only to bathtubs is controlled by

- a) an automatic compensating valve conforming to CSA B125.3, "Plumbing fittings," or
- b) a temperature-limiting device conforming to ASSE 1070/ASME A112.1070/CSA B125.70, "Performance requirements for water temperature limiting devices."

**3)** The requirement in Sentence (1) is permitted to be waived where the water is supplied by a single tempered water line controlled by an automatic compensating valve conforming to CSA B125.3, "Plumbing fittings."

**4)** Except as provided in Sentence (5), the temperature of water discharging from a shower head or into a bathtub shall not exceed 49°C.

**5)** In healthcare facilities and seniors' residences, the temperature of water discharging from a shower head or into a bathtub shall

- a) not exceed 43°C, and
- b) be adjusted at the shower or bathtub controls.

### 2.2.10.8. Direct Flush Valves

**1)** Direct flush valves shall

- a) open fully and close positively under service pressure,
- b) complete their cycle of operation automatically,
- c) be provided with a means of regulating the volume of water that they discharge,
- d) be provided with a *vacuum breaker* unless the *fixture* is designed so that *back-siphonage* cannot occur, and
- e) conform to ASSE 1037/ASME A112.1037/CSA B125.37, "Performance requirements for pressurized flushing devices for plumbing fixtures."

### 2.2.10.9. Drinking Fountain Bubblers

**1)** The orifice of drinking fountain bubblers shall

- a) be of the shielded type, and
- b) direct the water upward at an angle of approximately 45°.

**2)** Drinking fountain bubblers shall include a means of regulating the flow to the orifice.

- 3) Bubblers shall be installed only on drinking fountains. (See Note A-2.2.10.9.(3).)

#### 2.2.10.10. Back-Siphonage Preventers and Backflow Preventers

1) Except as provided in Sentence (2), *back-siphonage preventers* and *backflow preventers* shall conform to

- a) CSA B64.0, "Definitions, general requirements, and test methods for vacuum breakers and backflow preventers,"
- b) CSA B64.1.1, "Atmospheric vacuum breakers (AVB),"
- c) CSA B64.1.2, "Pressure vacuum breakers (PVB),"
- d) CSA B64.1.3, "Spill-resistant pressure vacuum breakers (SRPVB),"
- e) CSA B64.2, "Hose connection vacuum breakers (HCVB),"
- f) CSA B64.2.1, "Hose connection vacuum breakers (HCVB) with manual draining feature,"
- g) CSA B64.2.2, "Hose connection vacuum breakers (HCVB) with automatic draining feature,"
- h) CSA B64.3, "Dual check valve backflow preventers with atmospheric port (DCAP),"
- i) CSA B64.4, "Reduced pressure principle (RP) backflow preventers,"
- j) CSA B64.4.1, "Reduced pressure principle backflow preventers for fire protection systems (RPF),"
- k) CSA B64.5, "Double check valve (DCVA) backflow preventers,"
- l) CSA B64.5.1, "Double check valve backflow preventers for fire protection systems (DCVAF),"
- m) CSA B64.6, "Dual check valve (DuC) backflow preventers,"
- n) CSA B64.6.1, "Dual check valve backflow preventers for fire protection systems (DuCF),"
- o) CSA B64.7, "Laboratory faucet vacuum breakers (LFVB),"
- p) CSA B64.8, "Dual check valve backflow preventers with intermediate vent (DuCV)," or
- q) CSA B64.9, "Single check valve backflow preventers for fire protection systems (SCVAF)."

2) *Back-siphonage preventers* for tank-type water closets (anti-siphon fill valves) shall conform to ASSE 1002/ASME A112.1002/CSA B125.12, "Anti-siphon fill valves for water closet tanks."

#### 2.2.10.11. Relief Valves

1) Temperature-relief, pressure-relief, combined temperature- and pressure-relief, and vacuum-relief valves shall conform to ANSI Z21.22/CSA 4.4, "Relief Valves For Hot Water Supply Systems."

#### 2.2.10.12. Reducing Valves

1) Direct-acting water-pressure-reducing valves for domestic water supply systems shall conform to CAN/CSA-B356, "Water pressure reducing valves for domestic water supply systems."

#### 2.2.10.13. Solar Domestic Hot Water

1) Equipment for solar heating of *potable* water shall conform to CAN/CSA-F379 SERIES, "Packaged solar domestic hot water systems (liquid-to-liquid heat transfer)."

#### 2.2.10.14. Vent Pipe Flashing

- 1) Flashing fabricated on-site for *vent pipes* shall be fabricated from
- a) copper sheet not less than 0.33 mm thick,
  - b) aluminum sheet not less than 0.48 mm thick,
  - c) *alloyed zinc* sheet not less than 0.35 mm thick,
  - d) lead sheet not less than 1.73 mm thick,
  - e) galvanized steel sheet not less than 0.33 mm thick, or
  - f) polychloroprene (neoprene) not less than 2.89 mm thick.

**2.2.10.15.**

**2)** Prefabricated flashing for *vent pipes* shall conform to CSA B272, "Prefabricated Self-Sealing Roof Vent Flashings." (See Article 2.5.6.5. for location of *vent pipe* terminals.)

**2.2.10.15. Water Hammer Arresters**

**1)** Water hammer arresters shall conform to ANSI/ASSE 1010, "Water Hammer Arresters."

**2.2.10.16. Air Admittance Valves**

**1)** *Air admittance valves* shall conform to ASSE 1051, "Individual and Branch Type Air Admittance Valves for Sanitary Drainage Systems." (See Note A-2.2.10.16.(1).)

**2.2.10.17. Water Treatment Systems**

**1)** Point-of-use devices, including their disposable parts, used in *potable* water treatment systems shall conform to CAN/CSA-B483.1, "Drinking Water Treatment Systems."

**2.2.10.18. Flexible Water Connectors**

**1)** Flexible water connectors exposed to continuous pressure shall conform to ASME A112.18.6/CSA B125.6, "Flexible water connectors."

**Section 2.3. Piping****2.3.1. Application****2.3.1.1. General**

**1)** This Section applies to the construction and use of joints and connections, and the arrangement, protection, support and testing of piping.

**2.3.2. Construction and Use of Joints****2.3.2.1. Caulked Lead Drainage Joints**

**1)** Caulked lead drainage joints shall not be used except for cast-iron pipe in a *drainage system* or *venting system*, or between such pipe and

- a) other ferrous pipe,
- b) brass and copper pipe,
- c) a caulking ferrule, or
- d) a *trap standard*.

**2)** Every caulked lead drainage joint shall be firmly packed with oakum and tightly caulked with lead to a depth of not less than 25 mm.

**3)** No paint, varnish or other coating shall be applied on the lead until after the joint has been tested.

**4)** A length of hub and spigot pipe and pipe fittings in a *drainage system* shall be installed with the hub at the upstream end.

**2.3.2.2. Wiped Joints**

**1)** Wiped joints shall not be used except for sheet lead or lead pipe, or between such pipe and copper pipe or a ferrule.

**2)** Wiped joints in straight pipe shall

- a) be made of solder,
- b) have an exposed surface on each side of the joint at least 19 mm wide, and
- c) be not less than 10 mm thick at the thickest part.

**3)** Wiped flanged joints shall be reinforced with a lead flange that is not less than 19 mm wide.

**2.3.2.3. Screwed Joints**

- 1) In making a screwed joint, the ends of the pipe shall be reamed or filed out to the size of the bore and all chips and cuttings shall be removed.
- 2) No pipe-joint cement or paint shall be applied to the internal threads.

**2.3.2.4. Soldered Joints**

- 1) Soldered joints shall be made in accordance with ASTM B828, "Standard Specification for Making Capillary Joints by Soldering of Copper and Copper Alloy Tube and Fittings."

**2.3.2.5. Flared Joints**

- 1) In making a flared joint, the pipe shall be expanded with a proper flaring tool.
- 2) Flared joints shall not be used for hard (drawn) copper tube.

**2.3.2.6. Mechanical Joints**

- 1) Mechanical joints shall be made with compounded elastomeric rings that are held in compression by
  - a) stainless steel or cast-iron clamps, or
  - b) groove and shoulder type mechanical couplings.(See Note A-2.3.2.6.(1).)

**2.3.2.7. Cold-Caulked Joints**

- 1) Cold-caulked joints shall not be used except for bell and spigot pipe in a *water system*, a *drainage system* or a *venting system*.
- 2) Caulking compound used in cold-caulked joints shall be applied according to the manufacturer's directions.
- 3) Cold-caulked joints in a *drainage system* shall be firmly packed with oakum and tightly caulked with cold caulking compound to a depth of not less than 25 mm.

**2.3.2.8. Stainless Steel Welded Joints**

- 1) Stainless steel welded joints shall conform to ASME B31.9, "Building Services Piping."
- 2) Butt weld pipe fittings shall be at least as thick as the wall of the pipe used.

**2.3.3. Joints and Connections****2.3.3.1. Drilled and Tapped Joints**

- 1) Drilled and tapped joints shall not be made in a *sanitary drainage pipe* or *vent pipe* and fittings unless suitable provision has been made for drilling and tapping.

**2.3.3.2. Extracted Tees**

- 1) Tees may be extracted from the wall thickness of Types K and L copper tube used in a *water distribution system*, provided that
  - a) a tool specifically designed for the purpose is used,
  - b) the branch is at least one *NPS* smaller than the tube in which the tee is formed,
  - c) the end of the branch incorporates a means to prevent it from penetrating into the run and thereby obstructing flow, and
  - d) the joint at the tee is brazed with a filler metal having a melting point not below 540°C.

**2.3.3.3. Prohibition of Welding of Pipes and Fittings**

- 1) Cast-iron soil pipe and fittings shall not be welded.
- 2) Galvanized steel pipe and fittings shall not be welded.



**2.3.3.4.****2.3.3.4. Unions and Slip Joints**

(See Note A-2.2.3.1.(1) and (3).)

1) Except as provided in Sentence 2.4.6.3.(6), running thread and packing nut connections and unions with a gasket seal shall not be used downstream of a *trap weir* in a *drainage system* or in a *venting system*.

2) Slip joints shall not be used

a) in a *venting system*, or

b) in a *drainage system*, except to connect a *fixture trap* to a *fixture drain* in an accessible location.

**2.3.3.5. Increaser or Reducer**

1) Connections between 2 pipes of different *nominal pipe sizes* shall be made with an increaser or a reducer fitting installed so that it permits the system to be completely drained.

**2.3.3.6. Dissimilar Materials**

1) Adaptors, connectors or mechanical joints used to join dissimilar materials shall be designed to accommodate the required transition.

**2.3.3.7. Connection of Roof Drain to Leader**

1) *Roof drains* shall be securely connected to a *leader* and provision shall be made for expansion.

**2.3.3.8. Connection of Floor or Wall Outlet Fixtures**

1) Pedestal urinals, floor-mounted water closets and *S-trap standards* shall be connected to a *fixture drain* by a floor flange or other means of connection, except that a cast-iron *trap standard* may be caulked to a cast-iron pipe.

2) Except as provided in Sentence (3), floor flanges shall be brass.

3) Where cast-iron or plastic pipe is used, a floor flange of the same material is permitted to be used.

4) Floor flanges and *fixtures* shall be securely set on a firm base and fastened to the floor or *trap* flange of the *fixture*.

5) Water-closet bowls shall be securely attached to the floor flange, floor or wall carrier.

6) Joints in a floor flange or between a *fixture* and the *drainage system* shall be sealed with a resilient watertight and gas-tight seal.

7) Where a lead water-closet stub is used, the length of the stub below the floor flange shall be not less than 75 mm.

**2.3.3.9. Expansion and Contraction**

(See Note A-2.3.3.9.)

1) The design and installation of every piping system shall include means to accommodate its expansion and contraction caused by temperature changes, movement of the soil, *building* shrinkage or structural settlement. (See Note A-2.3.3.9.(1).)

**2.3.3.10. Copper Tube**

1) Types M and DWV copper tube shall not be bent.

**2.3.3.11. Indirect Connections**

1) Where a *fixture* or device is *indirectly connected*, the connections shall be made by terminating the *fixture drain* above the *flood level rim* of a *directly connected fixture* to form an *air break*.

2) The size of the *air break* shall at least equal the *NPS* of the *fixture drain, branch* or pipe that terminates above the *directly connected fixture*, and it shall be not less than 25 mm. (See Note A-2.3.3.11.(2).)

#### 2.3.3.12. Copper Joints Used Underground

1) Except as provided in Sentence (2), joints in copper tubes installed underground shall be made with either flared or compression fittings, or be brazed using a brazing alloy within the American Welding Society's AWS-BCuP range.

2) Compression fittings shall not be used underground under a *building*.

### 2.3.4. Support of Piping

#### 2.3.4.1. Capability of Support

1) Piping shall be provided with support that is capable of keeping the pipe in alignment and bearing the weight of the pipe and its contents.

2) Wall-mounted *fixtures* shall be supported so that no strain is transmitted to the piping.

#### 2.3.4.2. Independence of Support

1) Piping, *fixtures*, tanks or devices shall be supported independently of each other.

#### 2.3.4.3. Insulation of Support

1) Where a hanger or support for copper tube or brass or copper pipe is of a material other than brass or copper, it shall be suitably separated and electrically insulated from the pipe or tube.

2) Where a hanger or support for stainless steel pipe or tube is of a material other than stainless steel, it shall be suitably separated and electrically insulated from the pipe or tube.

#### 2.3.4.4. Support for Vertical Piping

1) Except as provided in Sentence (2), vertical piping shall be supported at its base and at the floor level of alternate *storeys* by rests, each of which can bear the weight of pipe that is between it and the rest above it.

2) The maximum spacing of supports shall be 7.5 m.

#### 2.3.4.5. Support for Horizontal Piping

1) *Nominally horizontal* piping that is inside a *building* shall be braced to prevent swaying and buckling and to control the effects of thrust.

2) *Nominally horizontal* piping shall be supported as stated in Table 2.3.4.5.

3) Where PVC, CPVC or ABS plastic pipe is installed,  
a) the pipe shall be aligned without added strain on the piping,  
b) the pipe shall not be bent or pulled into position after being welded, and  
c) hangers shall not compress, cut or abrade the pipe.

4) Where PEX, PE-RT, PP-R, PE/AL/PE or PEX/AL/PEX plastic pipe or tube is installed, hangers shall not compress, cut or abrade the pipe.

**Table 2.3.4.5.**  
**Support for Nominally Horizontal Piping**  
 Forming Part of Sentence 2.3.4.5.(2)

Piping Material	Maximum Horizontal Spacing of Supports, m	Additional Support Conditions
ABS or PVC plastic pipe	1.2	At the end of <i>branches</i> or <i>fixture drains</i> and at changes in direction and elevation
ABS or PVC plastic <i>trap arm</i> or <i>fixture drain</i> pipe > 1 m long	n/a	As close as possible to the <i>trap</i>
Cast-iron pipe	3.0	At or adjacent to each hub or joint
Cast-iron pipe with mechanical joints that is $\leq 300$ mm long between adjacent fittings	1.0	None
Copper tube or copper and brass pipe, hard temper		
• diameter > NPS 1	3.0	None
• diameter $\leq$ NPS 1	2.5	
Copper tube, soft temper	2.5	None
CPVC pipe	1.0	None
Galvanized iron or steel pipe		
• diameter $\geq$ NPS 6	3.75	None
• diameter < NPS 6	2.5	
Lead pipe	Throughout length of pipe	None
PE/AL/PE composite pipe	1.0	None
PEX/AL/PEX composite pipe	1.0	None
PEX plastic pipe	0.8	None
PE-RT tube	0.8	None
PP-R plastic pipe	1.0	At the end of <i>branches</i> and at changes in direction and elevation
Stainless steel pipe		
• diameter $\geq$ NPS 1	3.0	None
• diameter < NPS 1	2.5	
Stainless steel tube		
• diameter $\geq$ NPS 1	3.0	None
• diameter < NPS 1	2.5	

**5)** Where hangers are used to support *nominally horizontal* piping, the hangers shall be

- a) supported by metal rods of not less than
  - i) 6 mm diam to support piping of NPS 2 or less,
  - ii) 8 mm diam to support piping of NPS 4 or less, and
  - iii) 13 mm diam to support piping over NPS 4, or
- b) solid or perforated metal straps not less than
  - i) 0.6 mm thick and 12 mm wide to support piping of NPS 2 or less, and
  - ii) 0.8 mm thick and 18 mm wide to support piping of NPS 4 or less.

**6)** Where a hanger is attached to concrete or masonry, it shall be fastened by metal or expansion-type plugs that are inserted or built into the concrete or masonry.

**2.3.4.6. Support for Underground Horizontal Piping**

**1)** Except as provided in Sentence (2), *nominally horizontal* piping that is underground shall be supported on a base that is firm and continuous under the whole of the pipe. (See Note A-2.3.4.6.(1).)

**2)** *Nominally horizontal* piping installed underground that is not supported as described in Sentence (1) may be installed using hangers fixed to a foundation or structural slab provided that the hangers are capable of

- a) keeping the pipe in alignment, and
- b) supporting the weight of
  - i) the pipe,
  - ii) its contents, and
  - iii) the fill over the pipe.

**2.3.4.7. Support for Vent Pipe above a Roof**

**1)** Where a *vent pipe* that may be subject to misalignment terminates above the surface of a roof, it shall be supported or braced. (See Article 2.5.6.5. for location of *vent pipe* terminals.)

**2.3.5. Protection of Piping****2.3.5.1. Protection of Piping**

- 1)** Underground piping shall be protected
- a) in the absence of the pipe manufacturer's instructions for backfill, by backfill that is (see Note A-2.3.5.1.(1)(a))
    - i) placed and compacted to a height of 300 mm over the top of the pipe, and
    - ii) free of stones, boulders, cinders and frozen earth or other material capable of damaging the piping, or
  - b) by concrete that is at least 75 mm thick and at least 200 mm wider than the pipe.

**2.3.5.2. Isolation from Loads**

**1)** Where piping passes through or under a wall, it shall be installed so that the wall does not bear on the pipe.

**2.3.5.3. Protection Against Freezing**

(See Note A-2.3.5.3.)

**1)** Where piping may be exposed to freezing conditions, it shall be protected from the effects of freezing.

**2.3.5.4. Protection from Mechanical Damage**

**1)** Plumbing, piping and equipment exposed to mechanical damage shall be protected.

**2.3.5.5. Protection from Condensation**

(See Note A-2.3.5.3.)

**1)** Piping used as an internal *leader*, which may be subject to condensation, shall be installed in a manner that limits the risk of damage to the *building* due to condensation.

**2.3.6. Testing of Drainage or Venting Systems****2.3.6.1. Tests and Inspection of Drainage or Venting Systems**

**1)** Except in the case of an external *leader*, after a section of a *drainage system* or a *venting system* has been roughed in, and before any *fixture* is installed or piping is covered, a water pressure test or an air pressure test shall be conducted.

**2.3.6.2.**

- 2) After every *fixture* is installed and before any part of the *drainage system* or *venting system* is placed in operation, a final test shall be carried out when requested.
- 3) Where a prefabricated system is assembled off the *building* site in such a manner that it cannot be inspected and tested on site, off-site inspections and tests shall be conducted.
- 4) Where a prefabricated system is installed as part of a *drainage system* or *venting system*, all other plumbing work shall be tested and inspected and a final test shall be carried out on the complete system when requested.
- 5) When requested, a ball test shall be made to any pipe in a *drainage system*.

**2.3.6.2. Tests of Pipes in Drainage Systems**

- 1) Pipes in a *drainage system*, except an external *leader* or *fixture outlet pipe*, shall be capable of withstanding without leakage a water pressure test, air pressure test and final test.
- 2) Pipes in a *drainage system* shall be capable of meeting a ball test.

**2.3.6.3. Tests of Venting Systems**

- 1) *Venting systems* shall be capable of withstanding without leakage a water pressure test, air pressure test and final test.

**2.3.6.4. Water Pressure Tests**

- 1) A water pressure test shall consist in applying a water column of at least 3 m to all joints.
- 2) In making a water pressure test,
  - a) every opening except the highest shall be tightly closed with a testing plug or a screw cap, and
  - b) the system or the section shall be kept filled with water for 15 min.

**2.3.6.5. Air Pressure Tests**

- 1) Air pressure tests shall be conducted in accordance with the manufacturer's instructions for each piping material, and
  - a) air shall be forced into the system until a pressure of 35 kPa is created, and
  - b) this pressure shall be maintained for at least 15 min without a drop in pressure.

(See Note A-2.3.6.5.(1).)

**2.3.6.6. Final Tests**

- 1) Where a final test is made,
  - a) every *trap* shall be filled with water,
  - b) the bottom of the system being tested shall terminate at a *building trap*, test plug or cap,
  - c) except as provided in Sentence (2), smoke from smoke-generating machines shall be forced into the system,
  - d) when the smoke appears from all roof terminals, they shall be closed, and
  - e) a pressure equivalent to a 25 mm water column shall be maintained for 15 min without the addition of more smoke.
- 2) The smoke referred to in Clauses (1)(c) and (d) is permitted to be omitted, provided the roof terminals are closed and the system is subjected to an air pressure equivalent to a 25 mm water column maintained for 15 min without the addition of more air.

**2.3.6.7. Ball Tests**

- 1) Where a ball test is made, a hard ball dense enough not to float shall be rolled through the pipe.

- 2) The diameter of the ball shall be not less than
  - a) 50 mm where the size of the pipe is *NPS* 3 or more, or
  - b) 25 mm where the size of the pipe is less than *NPS* 3.

### 2.3.7. Testing of Potable Water Systems

#### 2.3.7.1. Application of Tests

- 1) After a section of a *potable water system* has been completed, and before it is placed in operation, a water pressure test shall be conducted, except that an air pressure test may be used in freezing conditions.
- 2) A pressure test may be applied to each section of the system or to the system as a whole.
- 3) Where a prefabricated system is assembled off the *building* site in such a manner that it cannot be inspected and tested on site, off-site inspections and pressure tests shall be conducted.
- 4) Where a prefabricated system is installed as part of a *water system*,
  - a) all other plumbing work shall be tested and inspected, and
  - b) the complete system shall be pressure tested when requested.

#### 2.3.7.2. Pressure Tests of Potable Water Systems

- 1) Except as required in Sentence (2), *potable water systems* shall be able to withstand
  - a) without leaking, a water pressure that is at least equal to the maximum in-service pressure, or
  - b) an air pressure of not less than 700 kPa for at least 2 h without a drop in pressure.
- 2) If a manufacturer states that an air pressure test is not recommended, a water pressure test shall be performed. (See Note A-2.3.7.2.(2).)

#### 2.3.7.3. Water Pressure Tests

- 1) Where a water pressure test is made, all air shall be expelled from the system before *fixture* control valves or faucets are closed.
- 2) *Potable water* shall be used to test a *potable water system*.

## Section 2.4. Drainage Systems

### 2.4.1. Application

#### 2.4.1.1. General

- 1) This Section applies to *sanitary drainage systems*, *storm drainage systems*, *combined building drains* or *combined building sewers*.

### 2.4.2. Connections to Drainage Systems

#### 2.4.2.1. Connections to Sanitary Drainage Systems

- 1) *Fixtures* shall be *directly connected* to a *sanitary drainage system*, except that
  - a) drinking fountains are permitted to be
    - i) *indirectly connected* to a *sanitary drainage system*, or
    - ii) connected to a *storm drainage system*, provided that where the system is subject to *backflow*, a *backwater valve* is installed in the fountain *fixture drain* (see Note A-2.4.2.1.(1)(a)(ii) and (e)(vi)),

- b) drainage pans on heating/cooling units are permitted to be connected to a *storm drainage system*, provided that where the system is subject to *backflow*, a *backwater valve* is installed,
- c) a floor drain is permitted to be connected to a *storm drainage system*, provided it is located where it can receive only *clear-water waste* or *storm water*,
- d) *fixtures* or appliances that discharge only *clear-water waste* are permitted to be connected to a *storm drainage system* or be drained onto a roof, and
- e) the following devices shall be *indirectly connected* to a *drainage system*:
  - i) a device for the display, storage, preparation or processing of food or drink,
  - ii) a sterilizer,
  - iii) a device that uses water as a cooling or heating medium,
  - iv) a water operated device,
  - v) a water treatment device, or
  - vi) a drain or overflow from a *water system* or a heating system (see Note A-2.4.2.1.(1)(a)(ii) and (e)(vi)).

**2)** The connection of a *sanitary drainage pipe* to a *nominally horizontal sanitary drainage pipe* or to a *nominally horizontal offset* in a *stack* shall be not less than 1.5 m measured horizontally from the bottom of a *stack* or from the bottom of the upper vertical section of the *stack* that

- a) receives a discharge of 30 or more *fixture units*, or
- b) receives a discharge from *fixtures* located on 2 or more *storeys*.

(See Note A-2.4.2.1.(2).)

**3)** No other *fixture* shall be connected to a lead bend or stub that serves a water closet.

**4)** Where a change in direction of more than 45° occurs in a *sanitary drainage pipe* that serves more than one clothes washer, and in which pressure zones are created by detergent suds, no other *sanitary drainage pipe* shall be connected to it within a length less than

- a) 40 times the *nominal pipe size* of the *sanitary drainage pipe* or 2.44 m maximum vertical, whichever is less, before changing direction, and
- b) 10 times the *nominal pipe size* of the *nominally horizontal sanitary drainage pipe* after changing direction.

(See Note A-2.4.2.1.(4) and (5).)

**5)** Where a *vent pipe* is connected into the suds pressure zone referred to in Sentence (4), no other *vent pipe* shall be connected to that *vent pipe* within the height of the suds pressure zone. (See Note A-2.4.2.1.(4) and (5).)

### 2.4.2.2. Connection of Overflows from Rainwater Tanks

**1)** An overflow from a rainwater tank shall not be *directly connected* to a *drainage system*.

### 2.4.2.3. Direct Connections

**1)** Two or more *fixture outlet pipes* that serve outlets from a single *fixture* that is listed in Clause 2.4.2.1.(1)(e) are permitted to be *directly connected* to a *branch* that

- a) has a *nominal pipe size* of not less than NPS 1¼, and
- b) is terminated above the *flood level rim* of a *directly connected fixture* to form an *air break*.

**2)** *Fixture drains* from *fixtures* that are listed in Subclauses 2.4.2.1.(1)(e)(i) and (e)(ii) are permitted to be *directly connected* to a *pipe* that

- a) is terminated to form an *air break* above the *flood level rim* of a *fixture* that is *directly connected* to a *sanitary drainage system*, and
- b) is extended through the roof when *fixtures* on 3 or more *storeys* are connected to it (see Note A-2.4.2.1.(1)(a)(ii) and (e)(vi)).

- 3) *Fixture drains from fixtures* that are listed in Subclauses 2.4.2.1.(1)(e)(iii) to (e)(vi) are permitted to be *directly connected* to a pipe that
- a) is terminated to form an *air break* above the *flood level rim* of a *fixture* that is *directly connected* to a *storm drainage system*, and
  - b) is extended through the roof when *fixtures* on 3 or more *storeys* are connected to it.

## 2.4.3. Location of Fixtures

### 2.4.3.1. Urinals

- 1) Urinals shall not be installed adjacent to wall and floor surfaces that are pervious to water. (See Article 3.7.2.5. of Division B of the NBC.)

### 2.4.3.2. Restricted Locations of Indirect Connections and Traps

- 1) Indirect connections or any *trap* that may overflow shall not be located in a crawl space or any other unfrequented area.

### 2.4.3.3. Equipment Restrictions Upstream of Grease Interceptors

- 1) Except as provided in Sentence (2), equipment discharging waste with organic solids shall not be located upstream of a grease *interceptor*. (See Note A-2.4.3.3.(1).)
- 2) An organic solids *interceptor* is permitted to be installed upstream of a grease *interceptor*.

### 2.4.3.4. Fixtures Located in Chemical Storage Locations

- 1) A floor drain or other *fixture* located in an oil transformer vault, a high voltage room or any room where flammable, dangerous or toxic chemicals are stored or handled shall not be connected to a *drainage system*.

### 2.4.3.5. Macerating Toilet Systems

- 1) A macerating toilet system shall only be installed where no connection to a gravity *sanitary drainage system* is available.

### 2.4.3.6. Drains Serving Elevator Pits

- 1) Where a drain is provided in an elevator pit,
- a) it shall be connected directly to a sump located outside the elevator pit, and
  - b) the drain pipe that connects the sump to the *drainage system* shall have a *backwater valve*.

## 2.4.4. Treatment of Sewage and Waste

### 2.4.4.1. Sewage Treatment

- 1) Where a *fixture* or equipment discharges *sewage* or waste that may damage or impair the *sanitary drainage system* or the functioning of a public or *private sewage disposal system*, provision shall be made for treatment of the *sewage* or waste before it is discharged to the *sanitary drainage system*.

### 2.4.4.2. Cooling of Hot Water or Sewage

- 1) Where a *fixture* discharges *sewage* or *clear-water waste* that is at a temperature above 75°C, provision shall be made for cooling of the waste to 75°C or less before it is discharged to the *drainage system*.

### 2.4.4.3. Interceptors

- 1) Where a *fixture* discharges *sewage* that includes fats, oils or grease and is located in a public kitchen, in a restaurant or in a *care, treatment or detention occupancy*, it shall discharge through a grease *interceptor*. (See Note A-2.4.4.3.(1).)



**2.4.4.4.**

- 2)** Where the discharge from a *fixture* may contain oil or gasoline, an oil *interceptor* shall be installed. (See Article 2.5.5.2. for venting requirements for oil *interceptors*.)
- 3)** Where a *fixture* discharges sand, grit or similar materials, an *interceptor* designed for the purpose of trapping such discharges shall be installed.
- 4)** *Interceptors* shall have sufficient capacity to perform the service for which it is provided.

**2.4.4.4. Neutralizing and Dilution Tanks**

- 1)** Where a *fixture* or equipment discharges corrosive or acid waste, it shall discharge into a neutralizing or dilution tank that is connected to the *sanitary drainage system* through
  - a) a *trap*, or
  - b) an indirect connection.
 (See Note A-2.4.4.4.(1).)
- 2)** Neutralizing and dilution tanks shall have a method for neutralizing the liquid.

**2.4.5. Traps****2.4.5.1. Traps for Sanitary Drainage Systems**

- 1)** Except as provided in Sentences (2) to (5) and in Article 2.4.5.2., *fixtures* shall be protected by a separate *trap*.
- 2)** One *trap* is permitted to protect
  - a) all the trays or compartments of a 2- or 3-compartment sink,
  - b) a 2-compartment laundry tray, or
  - c) 2 similar single compartment *fixtures* located in the same room.
 (See Note A-2.4.5.1.(2).)
- 3)** One *trap* is permitted to serve a group of floor drains or shower drains, a group of washing machines or a group of laboratory sinks if the *fixtures*
  - a) are in the same room, and
  - b) are not located where they can receive food or other organic matter.
 (See Note A-2.4.5.1.(3).)
- 4)** An *indirectly connected fixture* that can discharge only *clear-water waste* other than a drinking fountain need not be protected by a *trap*. (See Clause 2.4.2.1.(1)(e) for indirect connections.)
- 5)** An *interceptor* with an effective water seal of not less than 38 mm is permitted to serve as a *trap*. (See Note A-2.4.5.1.(5).)
- 6)** Where a domestic dishwashing machine equipped with a drainage pump discharges through a direct connection into the *fixture outlet pipe* of an adjacent kitchen sink or disposal unit, the pump discharge line shall rise as high as possible to just under the counter and connect
  - a) on the inlet side of the sink *trap* by means of a Y fitting, or
  - b) to the disposal unit.

**2.4.5.2. Traps for Storm Drainage Systems**

- 1)** Where a *storm drainage system* is connected to a *combined building sewer* or a public *combined sewer*, a *trap* shall be installed between any opening in the system and the drain or sewer, except that no *trap* is required if the opening is the upper end of a *leader* that terminates
  - a) at a roof that is used only for weather protection,
  - b) not less than 1 m above or not less than 3.5 m in any other direction from any air inlet, openable window or door, and
  - c) not less than 1.8 m from a property line.
 (See Note A-2.4.5.2.(1).)

- 2)** A floor drain that drains to a *storm drainage system* shall be protected by a *trap* that
- is located between the floor drain and a *leader, storm building drain* or *storm building sewer*,
  - may serve all floor drains located in the same room, and
  - need not be protected by a *vent pipe*.

**3)** Where freezing conditions could cause *storm drainage systems* to freeze due to air circulation within the piping, a *trap* with a *cleanout* shall be installed in a heated location.

#### 2.4.5.3. Connection of Subsoil Drainage Pipe to a Sanitary Drainage System

**1)** Where a *subsoil drainage pipe* is connected to a *sanitary drainage system*, the connection shall be made on the upstream side of a *trap* with a *cleanout* or a trapped sump. (See Note A-2.4.5.3.(1).)

#### 2.4.5.4. Location and Cleanout for Building Traps

- 1)** Where a *building trap* is installed, it shall
- be provided with a *cleanout* fitting on the upstream side of and directly over the *trap*,
  - be located upstream of the *building cleanout*, and
  - be located
    - inside the *building* as close as practical to the place where the *building drain* leaves the *building*, or
    - outside the *building* in a manhole.

(See Note A-2.4.5.4.(1).)

#### 2.4.5.5. Trap Seals

- 1)** Provision shall be made for maintaining the *trap* seal of a floor drain by
- the use of a *trap* seal primer,
  - using the drain as a receptacle for an *indirectly connected* drinking fountain, or
  - other equally effective means.

(See Note A-2.4.5.5.(1).)

### 2.4.6. Arrangement of Drainage Piping

#### 2.4.6.1. Separate Systems

- 1)** No vertical *sanitary drainage pipe* shall conduct both *sewage* and *storm water*.
- 2)** A *combined building drain* shall not be installed. (See Note A-2.1.2.1.(2).)
- 3)** There shall be no unused open ends in a *drainage system* and *dead ends* shall be so graded that water will not collect in them.

#### 2.4.6.2. Location of Sanitary Drainage Pipes

- 1)** A *sanitary drainage pipe* shall not be located directly above
- non-pressure *potable* water storage tanks,
  - manholes in pressure *potable* water storage tanks, or
  - food-handling or food-processing equipment.

#### 2.4.6.3. Sumps or Tanks

(See Note A-2.4.6.3.)

- 1)** Piping that is too low to drain into a *building sewer* by gravity shall be drained to a sump or receiving tank.
- 2)** Where the sump or tank receives *sewage*, it shall be water- and air-tight and shall be vented.

## 2.4.6.4.

- 3) Where the sump or tank receives subsurface water from a *subsoil drainage pipe*, it shall be provided with a water- and air-tight cover.
- 4) Equipment such as a pump or ejector that can lift the contents of the sump or tank and discharge it into the *building drain* or *building sewer* shall be installed.
- 5) Where the equipment does not operate automatically, the capacity of the sump shall be sufficient to hold at least a 24 h accumulation of liquid.
- 6) Where there is a *building trap*, the discharge pipe from the equipment shall be connected to the *building drain* downstream of the *trap*.
- 7) The discharge pipe from every pumped sump shall be equipped with a union, a *backwater valve* and a shut-off valve installed in that sequence in the direction of discharge.
- 8) The discharge piping from a pump or ejector shall be sized for optimum flow velocities at pump design conditions.

## 2.4.6.4. Protection from Backflow

- 1) A *subsoil drainage pipe* that drains into a *sanitary drainage system* that is subject to surcharge shall be connected in such a manner that *sewage* cannot back up into the *subsoil drainage pipe*. (See Note A-2.4.6.4.(1).)
- 2) Where a *building drain* or *branch* may be subject to *backflow*, a *backwater valve* shall be installed in accordance with Sentences (3) to (6).
- 3) Except as provided in Sentences (4) and (5), the *backwater valve* required by Sentence (2) shall be installed on every *fixture drain* connected to the *building drain* or *branch* where the *fixture* is located below the level of the adjoining street.
- 4) Where two or more *fixtures* located on a *storey* are connected to the same *branch*, the *backwater valve* required by Sentence (2) is permitted to be installed on the *branch*.
- 5) Except as provided in Sentence (6), the *backwater valve* required by Sentence (2) is permitted to be installed in the *building drain*, provided the *backwater valve*
  - a) does not serve more than one *dwelling unit*, and
  - b) has a "normally open" design conforming to
    - i) CSA B70, "Cast iron soil pipe, fittings, and means of joining,"
    - ii) CSA B181.1, "Acrylonitrile-butadiene-styrene (ABS) drain, waste, and vent pipe and pipe fittings,"
    - iii) CSA B181.2, "Polyvinylchloride (PVC) and chlorinated polyvinylchloride (CPVC) drain, waste, and vent pipe and pipe fittings," or
    - iv) CAN/CSA-B182.1, "Plastic drain and sewer pipe and pipe fittings."
- 6) A *backwater valve* or a gate valve that would prevent the free circulation of air shall not be installed in a *building drain* or in a *building sewer*.

## 2.4.6.5. Mobile Home Sewer Service

- 1) A *building sewer* intended to serve a mobile home shall be
  - a) not less than *NPS 4*,
  - b) terminated above ground,
  - c) provided with
    - i) a tamperproof terminal connection that is capable of being repeatedly connected, disconnected and sealed,
    - ii) a protective concrete pad, and
    - iii) a means to protect it from frost heave, and
  - d) designed and constructed in accordance with good engineering practice.

**2.4.7. Cleanouts**

**2.4.7.1. Cleanouts for Drainage Systems**

- 1)** *Sanitary drainage systems* and *storm drainage systems* shall be provided with *cleanouts* that will permit cleaning of the entire system.
- 2)** A *cleanout* fitting shall be provided on the upstream side and directly over every running *trap*.
- 3)** *Internal leaders* shall be provided with a *cleanout* fitting at the bottom of the *leader* or not more than 3 m upstream from the bottom of the *leader*.
- 4)** Where a *cleanout* is required on a *building sewer* of NPS 8 or larger, it shall be a manhole.
- 5)** A *building sewer* shall not change direction or slope between the *building* and public sewer or between *cleanouts*, except that pipes not more than NPS 6 may change direction
  - a) by not more than 5° every 3 m, or
  - b) by the use of fittings with a cumulative change in direction of not more than 45°.
- 6)** *Building drains* shall be provided with a *cleanout* fitting of NPS 4 or larger that is located as close as practical to the place where the *building drain* leaves the *building*. (See Note A-2.4.7.1.(6).)
- 7)** *Stacks* shall be provided with a *cleanout* fitting
  - a) at the bottom of the stack,
  - b) not more than 3 m upstream of the bottom of the stack, or
  - c) on a Y fitting connecting the stack to the *building drain* or *branch*.
- 8)** A *cleanout* shall be provided to permit the cleaning of the piping downstream of an *interceptor*.
- 9)** *Cleanouts* shall be installed so that the cumulative change in direction is not more than 90° between *cleanouts* in a drip pipe from a food receptacle or in a *fixture drain* serving a kitchen sink in a non-residential *occupancy*. (See Note A-2.4.7.1.(9).)
- 10)** A *fixture outlet pipe*, a *trap* with a removable *trap dip*, or a separate *cleanout* shall be used as a *cleanout* for a *fixture drain*. (See Note A-2.4.7.1.(10).)
- 11)** *Building drains* shall be provided with an additional *cleanout* for each cumulative horizontal change in direction exceeding 135°.

**2.4.7.2. Size and Spacing of Cleanouts**

- 1)** Except as provided in Sentences (2), (3) and 2.4.7.1.(6), the *nominal pipe size* and spacing of *cleanouts* in *nominally horizontal* pipes of a *drainage system* shall conform to Table 2.4.7.2.

**Table 2.4.7.2.**  
**Permitted Size and Spacing of Cleanouts**  
 Forming Part of Sentence 2.4.7.2.(1)

Nominal Pipe Size of Drainage Pipe, NPS	Minimum Nominal Pipe Size of Cleanout, NPS	Maximum Spacing, m	
		One-Way Rodding	Two-Way Rodding
less than 3	Same NPS as drainage pipe	7.5	15
3 and 4	3	15	30
over 4	4	26	52

- 2)** The spacing between manholes serving a *building sewer*
  - a) of NPS 24 or less shall not exceed 90 m, and
  - b) over NPS 24 shall not exceed 150 m.

**2.4.7.3.**

**3)** The *developed length* of a *building sewer* between the *building* and the first manhole to which the *building sewer* connects shall not exceed 75 m.

**4)** Where a *building sewer* connects to another *building sewer* other than by a manhole, the *developed length* between the *building* and the *building sewer* to which it connects shall not exceed 30 m.

**5)** *Cleanouts* that allow rodding in one direction only shall be installed to permit rodding in the direction of flow.

**2.4.7.3. Manholes**

**1)** A manhole, including the cover, shall be designed to support all loads imposed upon it.

- 2)** A manhole shall be provided with
- a) a cover that provides an airtight seal if located within a *building*,
  - b) a rigid ladder of a corrosion-resistant material where the depth exceeds 1 m, and
  - c) a vent to the exterior if the manhole is located within a *building*.

**3)** A manhole shall have a minimum horizontal dimension of 1 m, except that the top 1.5 m may be tapered from 1 m down to a minimum of 600 mm at the top.

**4)** A manhole in a *sanitary drainage system* shall be channeled to direct the flow of effluent.

**2.4.7.4. Location of Cleanouts**

**1)** *Cleanouts* and access covers shall be located so that their openings are readily accessible for drain cleaning purposes.

- 2)** A *cleanout* shall not be
- a) located in a floor assembly in a manner that may constitute a hazard, or
  - b) used as a floor drain.

**3)** There shall be no change of direction between a *cleanout* fitting and the *trap* that it serves.

**4)** The piping between a *cleanout* fitting and the *drainage system* it serves shall not change direction by more than 45°.

**5)** *Cleanouts* serving *fixture drains* in healthcare facilities, mortuaries, laboratories and similar *occupancies*, where contamination by hazardous waste is likely, shall be located a minimum of 150 mm above the *flood level rim* of the *fixture*. (See Note A-2.4.4.4.(1).)

**2.4.8. Minimum Slope and Length of Drainage Pipes****2.4.8.1. Minimum Slope**

**1)** Except as provided in Articles 2.4.10.8. and 2.4.10.9., drainage pipes that are *NPS* 3 or less shall have a downward slope in the direction of flow of at least 1 in 50. (See Note A-2.4.8.1.(1).)

**2.4.8.2. Length of Fixture Outlet Pipes**

**1)** Except for *fixture outlet pipes* installed in conformance with Sentence 2.4.5.1.(3), the *developed length* of *fixture outlet pipes* shall not exceed 1 200 mm. (See Note A-2.4.8.2.(1).) (See also Note A-2.4.5.1.(2).)

**2.4.9. Size of Drainage Pipes****2.4.9.1. No Reduction in Size**

- 1)** A *sanitary drainage pipe* shall be of a *nominal pipe size* not less than the *NPS* of
- a) a *vent pipe* that is connected to it, or
  - b) the largest *sanitary drainage pipe* that drains into it.

**2.4.9.2. Serving Water Closets**

- 1) Drainage pipes that serve a water closet shall be not less than *NPS* 3.
- 2) *Branch* and *building drains* downstream of the third water-closet *fixture drain* connection shall be not less than *NPS* 4.
- 3) *Stacks* that serve more than 6 water closets shall be not less than *NPS* 4.
- 4) Discharge pipes serving a macerating toilet system shall be not less than *NPS* ¾.

**2.4.9.3. Size of Fixture Outlet Pipes**

- 1) Except as provided in Sentence (2), the *nominal pipe size* of *fixture outlet pipes* shall conform to Table 2.4.9.3.
- 2) The part of the *fixture outlet pipe* that is common to 3 compartments of a sink shall be one *NPS* larger than the largest *fixture outlet pipe* of the compartments that it serves. (See Note A-2.4.9.3.(2).)

**Table 2.4.9.3.**  
**Minimum Permitted Size of Fixture Outlet Pipe and Hydraulic Loads for Fixtures<sup>(1)</sup>**  
 Forming Part of Sentences 2.4.9.3.(1) and 2.4.10.2.(1)

<i>Fixture</i>	<i>Minimum Nominal Pipe Size of Fixture Outlet Pipe, NPS</i>	<i>Hydraulic Load, fixture units</i>
Autopsy table	1½	2
<i>Bathroom group</i>		
(a) with flush tank	n/a	6
(b) with direct flush valve	n/a	8
Bathtub (with or without shower)	1½	1½
Bath: foot, sitz or slab	1½	1½
Beer cabinet	1½	1½
Bidet	1¼	1
Clothes washer		
(a) domestic <sup>(1)</sup>	n/a	2
(b) commercial	n/a	2
Dental unit or cuspidor	1¼	1
Dishwasher		
(a) domestic type	1½	1½ no load when connected to garbage grinder or domestic sink
(b) commercial type	2	3
Drinking fountain	1¼	½
Floor drain <sup>(2)</sup>	2	2 with <i>NPS</i> 2 <i>trap</i> 3 with <i>NPS</i> 3 <i>trap</i>
Garbage grinder, commercial type	2	3
Icebox	1¼	1
Laundry tray		
(a) single or double units or 2 single units with common <i>trap</i>	1½	1½
(b) 3 compartments	1½	2

Table 2.4.9.3. (Continued)

Fixture	Minimum Nominal Pipe Size of Fixture Outlet Pipe, NPS	Hydraulic Load, fixture units
Lavatory		
(a) barber or beauty parlor	1½	1½
(b) dental	1¼	1
(c) domestic type, single or 2 single with common trap	1¼	1 with NPS 1¼ trap 1½ with NPS 1½ trap
(d) multiple or industrial type	1½	according to Table 2.4.10.2.
Macerating toilet system	¾	4
Potato peeler	2	3
Shower drain		
Total volume of discharge from all shower heads and body sprays:		
(a) < 9.5 LPM	1½	1½
(b) 9.5 LPM to 20 LPM	2	3
(c) > 20 LPM	3	6
Sink		
(a) domestic and other small types with or without garbage grinders, single, double or 2 single with a common trap	1½	1½
(b) Other sinks	1½	1½ with NPS 1½ trap 2 with NPS 2 trap 3 with NPS 3 trap
Urinal		
(a) pedestal, siphon-jet or blowout type	2	4
(b) stall, washout type	2	2
(c) wall		
(i) washout type	1½	1½
(ii) other types	2	3
Water closet		
(a) with flush tank	3	4
(b) with direct flush valve	3	6

**Notes to Table 2.4.9.3.:**

- (1) See Note A-Table 2.4.9.3.  
(2) No hydraulic load for *emergency floor drains*.

**3)** Where clothes washers do not drain to a laundry tray, the trap inlet shall be not less than NPS 2 and be fitted with a vertical standpipe that is not less than 600 mm long measured from the trap weir and terminates above the flood level rim of the clothes washer. (See Note A-2.4.9.3.(3).)

**2.4.9.4. Size of Building Drain and Building Sewer**

**1)** Building drains and building sewers connected to the public sewer system downstream of the main cleanout (see Sentence 2.4.7.1.(6)) shall be not less than NPS 4.

**2.4.9.5. Offset in Leaders**

- 1) No change in the *nominal pipe size* of a *leader* with a *nominally horizontal offset* is required if the *offset*
  - a) is located immediately under the roof,
  - b) is not more than 6 m long, and
  - c) has a slope of not less than 1 in 50.
- 2) If the horizontal *offset* is more than 6 m long, the *leader* shall conform to Table 2.4.10.9.

**2.4.10. Hydraulic Loads**

(See Note A-2.4.10. for determination of hydraulic loads and *nominal pipe sizes* of drainage pipes.)

**2.4.10.1. Total Load on a Pipe**

- 1) The hydraulic load on a pipe is the total load from
  - a) every *fixture* that is connected to the system upstream of the pipe,
  - b) every *fixture* for which provision is made for future connection upstream of the pipe, and
  - c) all roofs and paved surfaces that drain into the system upstream of the pipe.

**2.4.10.2. Hydraulic Loads for Fixtures**

- 1) The hydraulic load from a *fixture* that is listed in Table 2.4.9.3. is the number of *fixture units* set forth in the Table.
- 2) Except as provided in Sentence (1), the hydraulic load from a *fixture* that is not listed in Table 2.4.9.3. is the number of *fixture units* set forth in Table 2.4.10.2. for the *nominal pipe size* of the *trap* that serves the *fixture*.

**Table 2.4.10.2.**  
**Permitted Hydraulic Load from a Fixture Based on Size of Trap**  
 Forming Part of Sentence 2.4.10.2.(2)

<i>Nominal Pipe Size of Trap, NPS</i>	<i>Hydraulic Load, fixture units</i>
1¼	1
1½	2
2	3
3	5
4	6

**2.4.10.3. Hydraulic Loads from Fixtures with a Continuous Flow**

- 1) Except as provided in Sentence (2), the hydraulic load from a *fixture* that produces a continuous flow, such as a pump or an air-conditioning *fixture*, is 31.7 *fixture units* for each litre per second of flow.
- 2) Where a *fixture* or equipment that produces a continuous or semi-continuous flow drains to a *combined sewer* or to a *storm sewer*, the hydraulic load from the *fixture* is 900 L for each litre per second of flow.

**2.4.10.4. Hydraulic Loads from Roofs or Paved Surfaces**

- 1) Except as provided in Sentence (2), the hydraulic load in litres from a roof or paved surface is the maximum 15 min rainfall determined in conformance with Subsection 1.1.3. of Division B of the NBC, multiplied by the sum of
  - a) the area in square metres of the horizontal projection of the surface drained, and
  - b) one-half the area in square metres of the largest adjoining vertical surface.
 (See Note A-2.4.10.4.(1).)



- 2)** *Flow control roof drains* may be installed, provided
- the maximum drain down time does not exceed 24 h,
  - the roof structure is designed to carry the load of the stored water,
  - one or more scuppers are installed not more than 30 m apart along the perimeter of the *building* so that
    - up to 200% of the 15-minute rainfall intensity can be handled, and
    - the maximum depth of controlled water is limited to 150 mm,
  - they are located not more than 15 m from the edge of the roof and not more than 30 m from adjacent drains, and
  - there is at least one drain for each 900 m<sup>2</sup>.
- 3)** Hydraulic loads, in litres per second, for *flow control roof drains* and restricted paved area drains shall be determined according to rain intensity-duration frequency curves as compiled by Environment Canada using 25-year frequencies.
- 4)** Where the height of the parapet is more than 150 mm or exceeds the height of the adjacent wall flashing,
- emergency roof overflows or scuppers described in Clause (2)(c) shall be provided, and
  - there shall be a minimum of 2 *roof drains*.

#### 2.4.10.5. Conversion of Fixture Units to Litres

- 1)** Except as provided in Sentence 2.4.10.3.(2), where the hydraulic load is to be expressed in litres, *fixture units* shall be converted as follows:
- when the number of *fixture units* is 260 or fewer, the load is 2 360 L, and
  - when the number of *fixture units* exceeds 260, the load is 9.1 L for each *fixture unit*.

#### 2.4.10.6. Hydraulic Loads to Sanitary Drainage Pipes

- 1)** Except as provided in Sentence (2), the hydraulic load that is drained to every *stack* shall conform to Table 2.4.10.6.-A.
- 2)** Where the *nominally horizontal offset* in a *stack* is 1.5 m or more, the hydraulic load that is served by it shall conform to Table 2.4.10.6.-B or Table 2.4.10.6.-C, whichever is the less restrictive.

**Table 2.4.10.6.-A**  
**Maximum Permitted Hydraulic Load Drained to a Stack**  
 Forming Part of Sentences 2.4.10.6.(1) and 2.5.7.3.(2), and Table 2.5.8.4.

Nominal Pipe Size of Stack, NPS	Maximum Hydraulic Load, <i>fixture units</i>	Maximum <i>Fixture Units</i> Drained from any 1 Storey
1¼	2	2
1½	8	2
2	24	6
3	102	18
4	540	100
5	1 400	250
6	2 900	500
8	7 600	830
10	15 000	2 700
12	26 000	4 680
15	50 000	9 000

**Table 2.4.10.6.-B**  
**Maximum Permitted Hydraulic Load Drained to a Branch**  
 Forming Part of Sentences 2.4.10.6.(2), 2.4.10.7.(1) and 2.5.7.3.(2)

Nominal Pipe Size of Branch, NPS	Maximum Hydraulic Load, fixture units
1¼	2
1½	3
2	6
3	27
4	180
5	390
6	700
8	1 600
10	2 500
12	3 900

**Table 2.4.10.6.-C**  
**Maximum Permitted Hydraulic Load Drained to a Sanitary Building Drain or Sewer**  
 Forming Part of Sentence 2.4.10.6.(2) and Article 2.4.10.8.

Nominal Pipe Size of Drain or Sewer, NPS	Maximum Hydraulic Load, fixture units					
	Slope					
	1 in 400	1 in 200	1 in 133	1 in 100	1 in 50	1 in 25
3	n/a	n/a	n/a	n/a	27	36
4	n/a	n/a	n/a	180	240	300
5	n/a	n/a	380	390	480	670
6	n/a	n/a	600	700	840	1 300
8	n/a	1 400	1 500	1 600	2 250	3 370
10	n/a	2 500	2 700	3 000	4 500	6 500
12	2 240	3 900	4 500	5 400	8 300	13 000
15	4 800	7 000	9 300	10 400	16 300	22 500

**2.4.10.7. Hydraulic Loads on Branches**

**1)** The hydraulic load that is drained to a *branch* shall conform to Table 2.4.10.6.-B.

**2.4.10.8. Hydraulic Loads on Sanitary Building Drains or Sewers**

**1)** The hydraulic load that is drained to a *sanitary building drain* or a *sanitary building sewer* shall conform to Table 2.4.10.6.-C.

**2.4.10.9. Hydraulic Loads on Storm or Combined Building Drains or Sewers**

**1)** The hydraulic load that is drained to a *storm building drain*, a *storm building sewer* or a *combined building sewer* shall conform to Table 2.4.10.9.

**Table 2.4.10.9.**  
**Maximum Permitted Hydraulic Load Drained to a Storm Building Drain or Sewer, or a Combined Building Sewer**  
 Forming Part of Sentence 2.4.9.5.(2) and Article 2.4.10.9.

Nominal Pipe Size of Drain or Sewer, NPS	Maximum Hydraulic Load, L						
	Slope						
	1 in 400	1 in 200	1 in 133	1 in 100	1 in 68	1 in 50	1 in 25
3	n/a	n/a	n/a	n/a	n/a	2 770	3 910
4	n/a	n/a	n/a	4 220	5 160	5 970	8 430
5	n/a	n/a	6 760	7 650	9 350	10 800	15 300
6	n/a	n/a	10 700	12 400	15 200	17 600	24 900
8	n/a	18 900	23 200	26 700	32 800	37 800	53 600
10	n/a	34 300	41 900	48 500	59 400	68 600	97 000
12	37 400	55 900	68 300	78 700	96 500	112 000	158 000
15	71 400	101 000	124 000	143 000	175 000	202 000	287 000

#### 2.4.10.10. Hydraulic Loads to Roof Gutters

- 1) The hydraulic load that is drained to a *roof gutter* shall conform to Table 2.4.10.10.

**Table 2.4.10.10.**  
**Maximum Permitted Hydraulic Load Drained to a Roof Gutter**  
 Forming Part of Article 2.4.10.10.

Nominal Pipe Size of Gutter, NPS	Area of Gutter, cm <sup>2</sup>	Maximum Hydraulic Load, L			
		Slope			
		1 in 200	1 in 100	1 in 50	1 in 25
3	22.8	406	559	812	1 140
4	40.5	838	1 190	1 700	2 410
5	63.3	1 470	2 080	2 950	4 170
6	91.2	2 260	3 200	4 520	6 530
7	124.1	3 250	4 600	6 500	9 190
8	162.1	4 700	6 600	9 400	13 200
10	253.4	8 480	12 000	17 000	23 600

#### 2.4.10.11. Hydraulic Loads on Leaders

- 1) The hydraulic load that is drained to a *leader* shall conform to Table 2.4.10.11.

**Table 2.4.10.11.**  
**Maximum Permitted Hydraulic Load Drained to a Leader**  
 Forming Part of Article 2.4.10.11.

Circular Leader		Non-Circular Leader	
Nominal Pipe Size of Leader, NPS	Maximum Hydraulic Load, L	Area of Leader, cm <sup>2</sup>	Maximum Hydraulic Load, L
2	1 700	20.3	1 520
2½	3 070	31.6	2 770
3	5 000	45.6	4 500
4	10 800	81.1	9 700
5	19 500	126.6	17 600
6	31 800	182.4	28 700
8	68 300	324.3	61 500

**2.4.10.12. Hydraulic Loads from Fixtures with a Semi-continuous Flow**

**1)** The hydraulic load from a *fixture* or equipment that produces a semi-continuous flow shall conform to Table 2.4.10.12.

**Table 2.4.10.12.**  
**Maximum Permitted Hydraulic Load from Fixtures with a Semi-continuous Flow**  
 Forming Part of Sentence 2.4.10.12.(1)

Nominal Pipe Size of Trap, NPS	Flow, L/s	Hydraulic Load, fixture units
1½	0.000 - 0.090	3
2	0.091 - 0.190	6
3	0.191 - 0.850	27
4	0.851 - 5.700	180

**2.4.10.13. Design of Storm Sewers**

**1)** Except as provided in Sentences 2.4.10.4.(1) and (2), and Article 2.4.10.9., *storm sewers* may be designed in accordance with good engineering practice.

**Section 2.5. Venting Systems**

**2.5.1. Vent Pipes for Traps**

**2.5.1.1. Venting for Traps**

**1)** Except as provided in Sentences (3) and (4), *traps* shall be protected by a *vent pipe*.

**2)** *Drainage systems* may require additional protection as provided in Subsections 2.5.4. and 2.5.5. by the installation of

- a) *branch vents,*
- b) *vent stacks,*
- c) *stack vents,*
- d) *vent headers,*
- e) *fresh air inlets,*
- f) *relief vents,*
- g) *circuit vents,*
- h) *yoke vents,*
- i) *offset relief vents,*
- j) *additional circuit vents,*
- k) *wet vents,*
- l) *individual vents,*
- m) *dual vents,* or
- n) *continuous vents.*

**3)** A *trap* that serves a floor drain need not be protected where

- a) the *nominal pipe size* of the *trap* is not less than *NPS 3,*
- b) the length of the *fixture drain* is not less than 450 mm, and
- c) the fall on the *fixture drain* does not exceed its *nominal pipe size.*

(See Note A-2.5.1.1.(3).)

**4)** A *trap* need not be protected by a *vent pipe*

- a) where it serves
  - i) a *subsoil drainage pipe,* or
  - ii) a *storm drainage system,* or
- b) where it forms part of an indirect *drainage system* (see also Clause 2.4.2.3.(2)(b)).

(See Note A-2.5.1.1.(4).)

**2.5.2.1.****2.5.2. Wet Venting****2.5.2.1. Wet Venting**

(See Note A-2.5.2.1.)

- 1)** A *sanitary drainage pipe* is permitted to serve as a *wet vent*, provided
  - a) the hydraulic load is in accordance with Table 2.5.8.1.,
  - b) the number of wet-vented water closets does not exceed 2,
  - c) where 2 water closets are installed, they are connected at the same level by means of a double sanitary T fitting if the *vent pipe* is vertical and by means of a double Y fitting if the *vent pipe* is horizontal,
  - d) the water closets are installed downstream of all other *fixtures*,
  - e) *trap arms* and *fixture drains* connected to the *wet vent* do not exceed NPS 2, except for connections from *emergency floor drains* in accordance with Sentence 2.5.1.1.(3),
  - f) the total hydraulic load on the *wet vent* does not exceed the limits stated in Table 2.5.8.1. when separately vented *branches* or *fixture drains* in the same *storey*, having a total hydraulic load not greater than 2 *fixture units*, are connected to the *wet vent* or a wet-vented water-closet *trap arm*,
  - g) the hydraulic load of separately vented *fixtures* that drain into the *wet vent* are not included when sizing the *continuous vent* that serves the *wet vent*,
  - h) where a *wet vent* extends through more than one *storey*, the total discharge from any one *storey* above the first *storey* does not exceed 4 *fixture units*,
  - i) there is not more than one *nominally horizontal offset* in the *wet vent*, and
    - i) the *offset* does not exceed 1.2 m for pipes of NPS 2 or less , or
    - ii) the *offset* does not exceed 2.5 m for pipes larger than NPS 2,
  - j) the *nominal pipe size* of the wet-vented portion is not reduced, except for the portion that is upstream of *emergency floor drains* in accordance with Sentence 2.5.1.1.(3), and
  - k) the length of the *wet vent* is not limited.

**2.5.3. Circuit Venting****2.5.3.1. Circuit Venting**

(See Note A-2.5.3.1.)

- 1)** A section of horizontal *branch* is permitted to be circuit-vented, provided
  - a) a *circuit vent* is connected to it,
  - b) all *fixtures* served by the *circuit vent* are located in the same *storey*, and
  - c) no *stack* is connected to it upstream of a circuit-vented *fixture*.
- 2)** *Fixtures* with *fixture outlet pipes* less than NPS 2 shall be separately vented or separately circuit-vented.
- 3)** Except as provided in Sentences (4) and (5), a *relief vent* shall be connected to the *branch* that forms part of a circuit-vented system, downstream of the connection of the most downstream circuit-vented *fixture*.
- 4)** A *sanitary drainage pipe* having a hydraulic load not greater than 6 *fixture units* is permitted to act as a *relief vent* for a *branch* that is circuit-vented.
- 5)** A symmetrically connected *relief vent* is permitted to serve as a combined *relief vent* for a maximum of 2 *branches* that are circuit-vented, provided there are not more than 8 circuit-vented *fixtures* connected between the combined *relief vent* and each *circuit vent*.
- 6)** *Additional circuit vents* shall be required
  - a) where each cumulative horizontal change in direction of a *branch* served by a *circuit vent* exceeds 45° between *vent pipe* connections, or
  - b) where more than 8 circuit-vented *fixtures* are connected to a *branch* between *vent pipe* connections.
- 7)** A *sanitary drainage pipe* is permitted to serve as an *additional circuit vent* in accordance with Sentence (6), provided the *sanitary drainage pipe* is sized as a *wet vent* in conformance with Article 2.5.8.1. and is not less than NPS 2.

**8)** Connections to *circuit vents* and *additional circuit vents* in accordance with Sentence (6) shall conform to Sentence 2.5.4.5.(1).

**9)** A circuit-vented *branch*, including the *fixture drain* downstream of the *circuit vent* connection, shall be sized in accordance with Article 2.4.10.7., except that it shall be not less than

- a) NPS 2, where *traps* less than NPS 2 are circuit-vented, or
- b) NPS 3, where *traps* of NPS 2 or larger are circuit-vented.

**10)** *Additional circuit vents* shall be sized in accordance with Table 2.5.7.1. and Sentence 2.5.7.3.(1).

**11)** The hydraulic load on a *circuit vent* shall include the hydraulic load from *fixtures* connected to the *branch* served by the *circuit vent*, but shall not include the hydraulic load from *fixtures* permitted by Sentences (3), (4) and (5).

## 2.5.4. Vent Pipes for Stacks

### 2.5.4.1. Stack Vents

- 1) The upper end of every *stack* shall terminate in a *stack vent*.

### 2.5.4.2. Vent Stacks

**1)** Except as provided in Sentence (2), every *stack* that drains *fixtures* from more than 4 *storeys* containing plumbing *fixtures* shall have a *vent stack*.

**2)** A *stack* that serves as a *wet vent* does not require a *vent stack*.

**3)** The *vent stack* required by Sentence (1) shall be connected to a vertical section of the *stack* at or immediately below the lowest *sanitary drainage pipe* connected to the *stack*.

**4)** *Fixtures* are permitted to be connected to a *vent stack*, provided

- a) the total hydraulic load of the connected *fixtures* does not exceed 8 *fixture units*,
- b) at least one *fixture* is connected to a vertical portion of the *vent stack* and upstream of any other *fixtures*,
- c) no other *fixture* is connected downstream of a water closet,
- d) all *fixtures* are located in the lowest *storey* served by the *vent stack*, and
- e) the section of the *vent pipe* that acts as a *wet vent* conforms to the requirements regarding *wet vents*.

### 2.5.4.3. Yoke Vents

(See Note A-2.5.4.3.)

**1)** Except as provided in Sentence (4), where a *stack* receives the discharge from *fixtures* located on more than 11 *storeys*, a *yoke vent* shall be installed

- a) for each section of 5 *storeys* or part thereof counted from the top down, and
- b) at or immediately above each *offset* or double *offset*.

**2)** The *yoke vent* shall be connected to the *stack* by means of a drainage fitting at or immediately below the lowest *sanitary drainage pipe* from the lowest *storey* of the sections described in Sentence (1).

**3)** The *yoke vent* shall connect to the *vent stack* at least 1 m above the floor level of the lowest *storey* in the section described in Sentence (1).

**4)** A *yoke vent* need not be installed provided the *stack* is interconnected with the *vent stack* in each *storey* of the section in which *fixtures* are located by means of a *vent pipe* equal in *nominal pipe size* to the *branch* or *fixture drain* or NPS 2, whichever is smaller.

### 2.5.4.4. Offset Relief Vents

**1)** A *stack* that has a *nominally horizontal offset* more than 1.5 m long and above which the upper vertical portion of the *stack* passes through more than 2 *storeys* and receives a hydraulic load of more than 100 *fixture units* shall be vented by an *offset relief*

**2.5.4.5.**

*vent* connected to the vertical section immediately above the *offset* and by another *offset relief vent*

- a) connected to the lower vertical section at or above the highest *sanitary drainage pipe* connection, or
  - b) extended as a vertical continuation of the lower section.
- (See Note A-2.5.4.4.(1).)

**2.5.4.5. Fixtures Draining into Vent Pipes**

**1)** The *trap arm* of a *fixture* that has a hydraulic load of not more than  $1\frac{1}{2}$  *fixture units* may be connected to the vertical section of a *circuit vent*, *additional circuit vent*, *offset relief vent* or *yoke vent*, provided

- a) not more than 2 *fixtures* are connected to the *vent pipe*,
  - b) where 2 *fixtures* are connected to the *vent pipe*, the connection is made by means of a double sanitary T fitting, and
  - c) the section of the *vent pipe* that acts as a *wet vent* is not less than *NPS 2*.
- (See Note A-2.5.4.5.(1).)

**2.5.5. Miscellaneous Vent Pipes****2.5.5.1. Venting of Sewage Sumps**

**1)** Every sump that receives *sewage* shall be provided with a *vent pipe* that is connected to the top of the sump. (See Article 2.5.7.7. for sizing of these vents.)

**2.5.5.2. Venting of Oil Interceptors**

(See Note A-2.5.5.2.) (See also Article 4.3.5.2. of Division B of the NFC.)

- 1)** Every oil *interceptor* shall be provided with 2 *vent pipes* that
  - a) connect to the *interceptor* at opposite ends,
  - b) extend independently to outside air, and
  - c) terminate not less than 2 m above ground and at elevations differing by at least 300 mm.
- 2)** Adjacent compartments within an oil *interceptor* shall be connected to each other by a vent opening.
- 3)** Where a secondary receiver for oil is installed in conjunction with an oil *interceptor*, it shall be vented in accordance with the manufacturer's recommendations, and the *vent pipe* shall
  - a) in no case be less than *NPS 1½*,
  - b) extend independently to outside air, and
  - c) terminate not less than 2 m above ground.
- 4)** The *vent pipes* referred to in Sentence (1) are permitted to be one *NPS* smaller than the largest connected drainage pipe but not less than *NPS 1¼*, or can be sized in accordance with the manufacturer's recommendations.
- 5)** A *vent pipe* that serves an oil *interceptor* and is located outside a *building* shall be not less than *NPS 3* in areas where it may be subject to frost closure.

**2.5.5.3. Venting of Drain Piping and Tanks for Corrosive Waste**

**1)** *Venting systems* for drain piping, neutralizing tanks, or dilution tanks conveying corrosive waste shall extend independently and terminate outdoors. (See Article 2.5.7.7. for sizing of these vents.)

**2.5.5.4. Fresh Air Inlets**

**1)** Where a *building trap* is installed, a *fresh air inlet* not less than *NPS 4* shall be connected upstream and within 1.2 m of the *building trap* and downstream of any other connection. (See Note A-2.4.5.4.(1).)

**2.5.5.5. Provision for Future Installations**

**1)** Where provision is made for a *fixture* to be installed in the future, the *drainage system* and *venting system* shall be sized accordingly and provision shall be made for the necessary future connections.

**2)** Except as required in Sentence 2.5.7.7.(2), where a *plumbing system* is installed in a *building*, every *storey* in which plumbing is or may be installed, including the basement of a single-family dwelling, shall have extended into it or passing through it a *vent pipe* that is at least *NPS 1½* for the provision of future connections.

**2.5.6. Arrangement of Vent Pipes**

**2.5.6.1. Drainage of Vent Pipes**

**1)** *Vent pipes* shall be installed without depressions in which moisture can collect.

**2.5.6.2. Vent Pipe Connections**

**1)** *Vent pipes* shall be installed in a *nominally vertical* position where it is practical to do so.

**2)** Except for *wet vents*, where a *vent pipe* is connected to a *nominally horizontal sanitary drainage pipe*, the connection shall be above the horizontal centre line of the *sanitary drainage pipe*. (See Note A-2.5.6.2.(2).)

**3)** Unused *vent pipes* installed for future connections shall be permanently capped with an end *cleanout* or an adapter and plug.

**2.5.6.3. Location of Vent Pipes**

**1)** Except as provided in Sentences (2) and (3), *vent pipes* that protect a *fixture trap* shall be located so that

- a) the *developed length* of the *trap arm* is not less than twice the *NPS* of the *fixture drain*,
- b) the total fall of the *trap arm* is not greater than its inside diameter, and
- c) the *trap arm* does not have a cumulative change in direction of more than 135°.

(See Note A-2.5.6.3.(1).)

**2)** The *trap arm* of water closets, of *S-trap standards* or of any other *fixture* that also discharges vertically and depends on siphonic action for its proper functioning shall not have a cumulative change in direction of more than 225°. (See Note A-2.5.6.3.(2).)

**3)** A *vent pipe* that protects a water closet or any other *fixture* that also depends on siphonic action for its proper functioning shall be located so that the distance between the connections of the *fixture drain* to the *fixture* and the *vent pipe* does not exceed

- a) 1 m in the vertical plane, and
- b) 3 m in the horizontal plane.

(See Note A-2.5.6.3.(3).)

**4)** The maximum length of every *trap arm* shall conform to Table 2.5.6.3.

**Table 2.5.6.3.**  
**Length of Trap Arm**  
Forming Part of Sentence 2.5.6.3.(4)

Nominal Pipe Size of Trap Served, NPS	Maximum Length of Trap Arm, m	Minimum Slope
1¼	1.5	1/50
1½	1.8	1/50
2	2.4	1/50
3	3.6	1/50
4	9.8	1/100



**2.5.6.4.****2.5.6.4. Connection of Vents above Fixtures Served**

- 1) Except for a *wet vent*, every *vent pipe* shall extend above the *flood level rim* of every *fixture* that it serves before being connected to another *vent pipe*.
- 2) No *vent pipe* shall be connected in such a manner that a blockage in a *sanitary drainage pipe* would cause waste to drain through the *vent pipe* to the *drainage system*.

**2.5.6.5. Terminals**

- 1) Except as provided in Sentence (3), the upper end of every *vent pipe* that is not terminated in outside air shall be connected to a *venting system* that terminates through a roof to outside air.
- 2) The upper end of every *vent pipe* that is terminated in outside air, other than a *vent pipe* that serves an oil *interceptor* or a *fresh air inlet*, shall be extended above the roof.
- 3) A *vent pipe* is permitted to be erected outside a *building*, provided that
  - a) no single change in direction of the *vent pipe* exceeds 45°,
  - b) all parts of the *vent pipe* are *nominally vertical*,
  - c) in areas where the *vent pipe* may be subject to frost closure, it is increased to not less than *NPS 3* before penetrating a wall or roof, and
  - d) where the *building* is 4 *storeys* or less in height, the *vent pipe* terminates above the roof of the *building*.
- 4) Except for a *fresh air inlet*, where a *vent pipe* is terminated in outside air, the terminal shall be located
  - a) not less than 1 m above and not less than 3.5 m in any other direction from every air inlet, openable window or door,
  - b) not less than 2 m above and not less than 3.5 m in any other direction from a roof that supports an *occupancy*,
  - c) not less than 2 m above ground, and
  - d) not less than 1.8 m from every property line.(See Note A-2.5.6.5.(4).)
- 5) Where a *vent pipe* passes through a roof, it shall
  - a) be terminated high enough to prevent the entry of roof drainage but not less than 150 mm above the roof or above the surface of *storm water*, which could pond on the roof (see Note A-2.5.6.5.(4)), and
  - b) be provided with flashing to prevent the entry of water between the *vent pipe* and the roof (see Article 2.2.10.14.).
- 6) Where a *vent pipe* passes through a roof and may be subject to frost closure, it shall be protected from frost closure by
  - a) increasing its diameter at least one *NPS*, but not less than *NPS 3*, immediately before it penetrates the roof,
  - b) insulating the pipe, or
  - c) protecting it in some other manner.(See Article 2.3.4.7.)

**2.5.7. Minimum Size of Vent Pipes****2.5.7.1. General**

- 1) The *nominal pipe size* of every *vent pipe* shall conform to Table 2.5.7.1.

**Table 2.5.7.1.**  
**Minimum Permitted Size of Vent Pipe Based on Size of Trap Served**  
 Forming Part of Sentences 2.5.7.1.(1) and 2.5.8.2.(1)

Nominal Pipe Size of Trap Served, NPS	Minimum Nominal Pipe Size of Vent Pipe, NPS
1¼	1¼
1½	1¼
2	1½
3	1½
4	1½
5	2
6	2

**2.5.7.2. Size Restriction**

- 1) The *nominal pipe size* of a *branch vent, stack vent, vent stack* or *vent header* shall be not less than the *nominal pipe size* of the *vent pipe* to which it is connected.
- 2) *Sanitary building drains* shall be provided with at least one vent that is not less than NPS 3.

**2.5.7.3. Additional Circuit Vents and Relief Vents**

- 1) Except as provided in Article 2.5.7.1. and Sentence 2.5.3.1.(7), the minimum *nominal pipe size* of an *additional circuit vent* or *relief vent* installed in conjunction with a *circuit vent* is permitted to be one NPS smaller than the required *nominal pipe size* of the *circuit vent*, but need not be larger than NPS 2.
- 2) The *nominal pipe size* of the *sanitary drainage pipe* acting as a *relief vent* in accordance with Sentence 2.5.3.1.(4) shall be in conformance with Table 2.4.10.6.-A, 2.4.10.6.-B or 2.5.8.1., and Article 2.5.7.1., whichever *nominal pipe size* is the largest considering the hydraulic load drained into the *sanitary drainage pipe*.

**2.5.7.4. Offset Relief Vents**

- 1) Except as provided in Article 2.5.7.1., the minimum *nominal pipe size* of an *offset relief vent* is permitted to be one NPS smaller than the NPS of the *stack vent*.

**2.5.7.5. Yoke Vents**

- 1) *Yoke vents* required by Sentence 2.5.4.3.(1) are permitted to be one NPS smaller than the NPS of the smallest pipe to which they are connected.

**2.5.7.6. Vent Pipes for Manholes**

- 1) The minimum *nominal pipe size* of a *vent pipe* that serves a manhole within a *building* shall be NPS 2.

**2.5.7.7. Vents for Sewage Sumps, Neutralizing and Dilution Tanks, and Macerating Toilet Systems**

- 1) Except as provided in Sentences (2) and (3), the minimum *nominal pipe size* of the *vent pipe* for a *sewage sump* or *neutralizing* or *dilution tank* shall be one NPS smaller than the NPS of the largest *branch* or *fixture drain* draining to the sump.
- 2) The *nominal pipe size* of every *vent pipe* for a *sewage sump* or *neutralizing* or *dilution tank* shall be not less than NPS 2, but need not be greater than NPS 4.
- 3) The *nominal pipe size* of a *vent pipe* for a *macerating toilet system* with a sump shall be not less than NPS 1½.

**2.5.8.1.**

**2.5.8. Sizing of Vent Pipes**

(See Note A-2.5.8. for an explanation on the sizing of *vent pipes*.)

**2.5.8.1. Hydraulic Loads Draining to Wet Vents**

- 1) The hydraulic load that drains to a *wet vent* shall conform to Table 2.5.8.1.
- 2) When determining the *nominal pipe size* of a *wet vent*, the hydraulic load from the most downstream *fixture* or symmetrically connected *fixtures* shall not be included. (See Note A-2.5.8.1.(2).)

**Table 2.5.8.1.**  
**Maximum Permitted Hydraulic Loads Drained to a Wet Vent**  
 Forming Part of Sentences 2.5.7.3.(2) and 2.5.8.1.(1)

Nominal Pipe Size of Wet Vent, NPS	Maximum Hydraulic Load, <i>fixture units</i>	
	Not Serving Water Closets	Fixtures, Other Than Water Closets, That Serve Not More Than 2 Water Closets
1½	2	n/a
2	4	3
3	12	8
4	36	14
5	n/a	18
6	n/a	23

**2.5.8.2. Individual Vents and Dual Vents**

- 1) The *nominal pipe size* of *individual vents* and *dual vents* shall be determined using Table 2.5.7.1. based on the largest *trap* served.
- 2) When sizing an *individual vent* or a *dual vent*, the length is not taken into consideration.

**2.5.8.3. Branch Vents, Vent Headers, Continuous Vents and Circuit Vents**

(See Note A-2.5.8.3. and 2.5.8.4.)

- 1) *Branch vents, vent headers, circuit vents* and *continuous vents* shall be sized in accordance with Table 2.5.8.3., unless they are *individual vents* or *dual vents*.
- 2) For the purposes of Table 2.5.8.3., the length of a *branch vent* shall be its *developed length* from the most distant *sanitary drainage pipe* connection to a *vent stack, stack vent, vent header* or outside air.
- 3) For the purposes of Table 2.5.8.3., the length of a *vent header* shall be its *developed length* from the most distant *sanitary drainage pipe* connection to outside air.
- 4) For the purposes of Table 2.5.8.3., the length of a *circuit vent* shall be its *developed length* from the horizontal *sanitary drainage pipe* connection to a *vent stack, stack vent, vent header* or outside air.
- 5) For the purposes of Table 2.5.8.3., the length of a *continuous vent* shall be its *developed length* from the vertical *sanitary drainage pipe* connection to a *vent stack, stack vent, vent header* or outside air.

**Table 2.5.8.3.**  
**Sizing of Branch Vents, Vent Headers, Circuit Vents and Continuous Vents<sup>(1)</sup>**  
 Forming Part of Article 2.5.8.3.

Total Hydraulic Load Served by Vent Pipe, fixture units	Nominal Pipe Size of Vent Pipe, NPS							
	1¼	1½	2	3	4	5	6	8
	Maximum Length of Vent Pipe, m							
2	9	NL	NL	NL	NL	NL	NL	NL
8	9	30	61	NL	NL	NL	NL	NL
20	7.5	15	46	NL	NL	NL	NL	NL
24	4.5	9	30	NL	NL	NL	NL	NL
42	NP	9	30	NL	NL	NL	NL	NL
60	NP	4.5	15	120	NL	NL	NL	NL
100	NP	NP	11	79	305	NL	NL	NL
200	NP	NP	9	76	275	NL	NL	NL
500	NP	NP	6	55	215	NL	NL	NL
1 100	NP	NP	NP	15	61	215	NL	NL
1 900	NP	NP	NP	6	21	61	215	NL
2 200	NP	NP	NP	NP	9	27	105	335
3 600	NP	NP	NP	NP	7.5	18	76	245
5 600	NP	NP	NP	NP	NP	7.5	18	76

**Notes to Table 2.5.8.3.:**

(1) NP = not permitted and NL = not limited.

**2.5.8.4. Vent Stacks or Stack Vents**

(See Note A-2.5.8.3. and 2.5.8.4.)

- 1)** A *vent stack* or *stack vent* shall be sized in accordance with Table 2.5.8.4. based on
  - a) the length of the *vent stack* or *stack vent*, and
  - b) the total hydraulic load that is drained to the lowest section of a *stack* served by the *vent pipe*, plus any additional vent loads connected to the *vent stack* or *stack vent*.
  
- 2)** For the purposes of Table 2.5.8.4., the length of a *stack vent* or *vent stack* shall be its *developed length* from its lower end to outside air.
  
- 3)** The minimum *nominal pipe size* of a *vent stack* or *stack vent* shall be one-half the *NPS* of the *stack* at its base.
  
- 4)** A *stack vent* serving a *wet vent* stack that is over 4 *storeys* high shall extend the full size of the *wet vent* to outside air.

**Table 2.5.8.4.**  
**Size and Developed Length of Stack Vents and Vent Stacks<sup>(1)</sup>**  
 Forming Part of Sentences 2.5.8.4.(1) and (2)

Nominal Pipe Size of Stack, NPS <sup>(2)</sup>	Total Hydraulic Load Being Vented, fixture units	Nominal Pipe Size of Stack Vent or Vent Stack, NPS										
		1¼	1½	2	3	4	5	6	8	10	12	
		Maximum Length of Stack Vent or Vent Stack, m										
1¼	2	9	NL	NL	NL	NL	NL	NL	NL	NL	NL	NL
	1½	8	15	46	NL	NL	NL	NL	NL	NL	NL	NL
2		12	9	23	61	NL	NL	NL	NL	NL	NL	NL
	3	24	8	15	46	NL	NL	NL	NL	NL	NL	NL
10		NP	13	46	317	NL	NL	NL	NL	NL	NL	NL
21		NP	10	33.5	247	NL	NL	NL	NL	NL	NL	NL
53		NP	8	28.5	207	NL	NL	NL	NL	NL	NL	NL
4	102	NP	7.5	26	189	NL	NL	NL	NL	NL	NL	NL
	43	NP	NP	10.5	76	299	NL	NL	NL	NL	NL	NL
	140	NP	NP	8	61	229	NL	NL	NL	NL	NL	NL
	320	NP	NP	7	52	195	NL	NL	NL	NL	NL	NL
5	540	NP	NP	6.5	46	177	NL	NL	NL	NL	NL	NL
	190	NP	NP	NP	25	97.5	302	NL	NL	NL	NL	NL
	490	NP	NP	NP	19	76	232	NL	NL	NL	NL	NL
	940	NP	NP	NP	16	64	204	NL	NL	NL	NL	NL
6	1 400	NP	NP	NP	15	58	180	NL	NL	NL	NL	NL
	500	NP	NP	NP	10	39.5	122	305	NL	NL	NL	NL
	1 100	NP	NP	NP	8	30.5	94.5	238	NL	NL	NL	NL
	2 000	NP	NP	NP	6.5	25.5	79	201	NL	NL	NL	NL
8	2 900	NP	NP	NP	6	23.5	73	183	NL	NL	NL	NL
	1 800	NP	NP	NP	NP	9.5	29	73	287	NL	NL	NL
	3 400	NP	NP	NP	NP	7	22	58	219.5	NL	NL	NL
	5 600	NP	NP	NP	NP	6	19	49	186	NL	NL	NL
10	7 600	NP	NP	NP	NP	5.5	17	43	170.5	NL	NL	NL
	4 000	NP	NP	NP	NP	NP	9.5	24	94.5	292.5	NL	NL
	7 200	NP	NP	NP	NP	NP	7	18	73	225.5	NL	NL
	11 000	NP	NP	NP	NP	NP	6	15.5	61	192	NL	NL
12	15 000	NP	NP	NP	NP	NP	5.5	14	55	174	NL	NL
	7 300	NP	NP	NP	NP	NP	NP	9.5	36.5	116	287	NL
	13 000	NP	NP	NP	NP	NP	NP	7	28.5	91	219.5	NL
	20 000	NP	NP	NP	NP	NP	NP	6	24	76	186	NL
15	26 000	NP	NP	NP	NP	NP	NP	5.5	22	70	152	NL
	15 000	NP	NP	NP	NP	NP	NP	NP	12	39.5	94.5	NL
	25 000	NP	NP	NP	NP	NP	NP	NP	9.5	29	73	NL
	38 000	NP	NP	NP	NP	NP	NP	NP	8	24.5	61	NL
15	50 000	NP	NP	NP	NP	NP	NP	NP	7	22.5	55	NL

**Notes to Table 2.5.8.4.:**

- (1) NP = not permitted and NL = not limited.
- (2) Stacks shall be sized using Table 2.4.10.6.-A.

© His Majesty the King in Right of Canada, as represented by the National Research Council of Canada, 2025 © Sa Majesté le Roi du chef du Canada, représenté par le Conseil national de recherches du Canada, 2025

**2.5.8.5. Lengths of Other Vent Pipes**

1) When sizing an *additional circuit vent*, *offset relief vent*, *relief vent*, *yoke vent*, and the *vent pipe* for an *interceptor*, *dilution tank*, *sewage tank*, *sump*, or *manhole*, length is not taken into consideration.

**2.5.9. Air Admittance Valves**

(See Note A-2.2.10.16.(1).)

**2.5.9.1. Air Admittance Valve as a Vent Terminal**

1) *Individual vents* and *dual vents* are permitted to terminate with a connection to an *air admittance valve* as provided in Articles 2.5.9.2. and 2.5.9.3. (See also Sentence 2.2.10.16.(1).)

**2.5.9.2. Air Admittance Valves**

- 1) *Air admittance valves* shall only be used to vent
  - a) *fixtures* located in island counters,
  - b) *fixtures* that may be affected by frost closure of the vent due to local climatic conditions,
  - c) *fixtures* in one- and two-family dwellings undergoing renovation, or
  - d) installations where connection to a vent may not be practical.
- 2) *Air admittance valves* shall be located
  - a) not less than 100 mm above the *fixture drain* being vented,
  - b) within the maximum *developed length* permitted for the vent, and
  - c) not less than 150 mm above insulation materials.

**2.5.9.3. Installation Conditions**

- 1) *Air admittance valves* shall not be installed in supply or return air plenums, or in locations where they may be exposed to freezing temperatures.
- 2) *Air admittance valves* shall be installed in accordance with the manufacturer's installation instructions.
- 3) *Air admittance valves* shall be rated for the *nominal pipe size* of *vent pipe* to which they are connected.
- 4) Installed *air admittance valves* shall be
  - a) accessible, and
  - b) located in a space that allows air to enter the valve.
- 5) *Drainage systems* shall have at least one vent that terminates to the outdoors in conformance with Sentence 2.5.6.5.(1).

## Section 2.6. Potable Water Systems

**2.6.1. Arrangement of Piping****2.6.1.1. Design**

- 1) *Fixtures* supplied with separate hot and cold water controls shall have the hot water control on the left and the cold on the right.
- 2) In a hot *water distribution system* of a *developed length* of more than 30 m or supplying more than 4 *storeys*, the water temperature shall be maintained by
  - a) recirculation, or
  - b) a self-regulating heat tracing system.

**2.6.1.2. Drainage**

- 1) A *water distribution system* shall be installed so that the system can be drained or blown out with air.

**2.6.1.3. Shut-off Valves**

- 1) *Water service pipes* shall be provided with an accessible shut-off valve located as close as possible to where the *water service pipe* enters the *building*.
- 2) Pipes that convey water from a gravity water tank or from a *private water supply system* shall be fitted with a shut-off valve at the source of supply.
- 3) Except for *risers* that serve only one *dwelling unit*, *risers* shall be provided with a shut-off valve located at the source of supply.
- 4) Water closets shall be provided with a shut-off valve on their water supply pipe.
- 5) In *buildings* of residential *occupancy* that contain more than one *dwelling unit*, a shut-off valve shall be installed where the water supply enters each *dwelling unit*, so that, when the water supply to one *suite* is shut off, the water supply to the remainder of the *building* is not interrupted. (See Note A-2.6.1.3.(5).)
- 6) In *buildings* of other than residential *occupancy*, shut-off valves shall be provided on the water supply to
  - a) every *fixture*, or
  - b) any group of *fixtures* in the same room, except as provided in Sentence (4).
- 7) Pipes that supply water to a hot water tank shall be provided with a shut-off valve located close to the tank.

**2.6.1.4. Protection for Exterior Water Supply**

- 1) Pipes that pass through an exterior wall to supply water to the exterior of the *building* shall be provided with
  - a) a frost-proof hydrant, or
  - b) a stop-and-waste cock located inside the *building* and close to the wall.

**2.6.1.5. Check Valves**

- 1) A *check valve* shall be installed at the *building* end of a *water service pipe* where the pipe is made of plastic that is suitable for cold water use only.

**2.6.1.6. Flushing Devices**

- 1) Flushing devices that serve water closets or urinals shall have sufficient capacity and be adjusted to deliver at each operation a volume of water that will thoroughly flush the *fixture* or *fixtures* they serve.
- 2) Where a manually operated flushing device is installed, it shall serve only one *fixture*.
- 3) Except as provided in Sentence (4), water closets and urinals shall have an integral means of limiting the maximum amount of water used in each flush cycle to that specified in Table 2.6.1.6.

**Table 2.6.1.6.**  
**Water Usage per Flush Cycle**  
Forming Part of Sentence 2.6.1.6.(3)

<i>Fixtures</i>	Maximum Water Usage per Flush Cycle, Lpf
Water closets – residential	
single-flush	4.8
dual-flush: 6.0/4.1 Lpf	4.8
Water closets – industrial, commercial, institutional	6.0
Urinals	1.9

- 4) In residential retrofits, a maximum water usage of 6.0 Lpf shall be permitted for single-flush water closets where it can be demonstrated that a maximum water usage of 4.8 Lpf would be impracticable given the existing *building* or municipal infrastructure.

5) Except where installed in *buildings* not intended to be occupied year-round, flush-tank-type urinals shall be equipped with a device capable of preventing flush cycles when they are not in use. (See Note A-2.6.1.6.(5).)

### 2.6.1.7. Relief Valves

- 1) In addition to the requirements in Sentence (2), the hot water tank of a *storage-type service water heater* shall be equipped with a pressure-relief valve
  - a) designed to open when the water pressure in the tank reaches the rated working pressure of the tank, and
  - b) so located that the pressure in the tank shall not exceed the pressure at the relief valve by more than 35 kPa under any condition of flow within the distribution system.
- 2) The hot water tank of a *storage-type service water heater* shall be equipped with a temperature-relief valve with a temperature-sensing element
  - a) located within the top 150 mm of the tank, and
  - b) designed to open and discharge sufficient water from the tank to keep the temperature of the water in the tank from exceeding 99°C under all operating conditions.
- 3) A pressure-relief valve and temperature-relief valve may be combined where Sentences (1) and (2) are complied with.
- 4) *Indirect service water heaters* shall be equipped with
  - a) a pressure-relief valve, and
  - b) a temperature-relief valve on every storage tank that forms part of the system.
- 5) Pipes that convey water from a temperature-relief, pressure-relief or combined temperature- and pressure-relief valve shall
  - a) be of a *nominal pipe size* at least equal to the *NPS* of the outlet of the valve,
  - b) be rigid, slope downward from the valve, and terminate with an indirect connection above a floor drain, sump, or other safe location, with an *air break* of not more than 300 mm,
  - c) have no thread at their outlet, and
  - d) be capable of operating at a temperature of not less than 99°C.(See Note A-2.6.1.7.(5).)
- 6) The temperature-relief valve required in Clause (4)(b) shall
  - a) have a temperature-sensing element located within the top 150 mm of the tank, and
  - b) be designed to open and discharge sufficient water to keep the temperature of the water in the tank from exceeding 99°C under all operating conditions.
- 7) No shut-off valve shall be installed on the pipe between any tank and the relief valves or on the discharge lines from such relief valves.
- 8) A vacuum-relief valve shall be installed when any tank may be subject to *back-siphonage*.
- 9) *Storage-type service water heaters* that are located in a ceiling or roof space, or over a floor of wood construction, shall be installed within a corrosion-resistant watertight drain pan, as described in Sentence (10).
- 10) The drain pan referred to in Sentence (9) shall
  - a) be not less than 50 mm larger than the tank and have side walls not less than 25 mm high,
  - b) be drained by a pipe two *NPS* larger than the relief valve discharge pipe, and
  - c) have a drain that is located directly under the relief valve discharge pipe and that discharges directly to a floor drain or other acceptable location.

### 2.6.1.8. Solar Domestic Hot Water Systems

1) Systems for solar heating of *potable* water shall be installed in conformance with CAN/CSA-F383, "Installation of packaged solar domestic hot water systems."



**2.6.1.9.****2.6.1.9. Water Hammer**

**1)** Provision shall be made to protect the *water distribution system* from the adverse effects of water hammer. (See Note A-2.6.1.9.(1).)

**2.6.1.10. Mobile Home Water Service**

- 1)** A *water service pipe* intended to serve a mobile home shall
- a) be not less than *NPS*  $\frac{3}{4}$ ,
  - b) terminate above ground, and
  - c) be provided with
    - i) a tamperproof terminal connection that is capable of being repeatedly connected, disconnected and sealed,
    - ii) a protective concrete pad,
    - iii) a means to protect it from frost heave, and
    - iv) a curb stop and a means of draining that part of the pipe located above the frost line when not in use.

**2.6.1.11. Thermal Expansion**

- 1)** Where thermal expansion can occur, protection shall be provided for
- a) *check valves* required by Article 2.6.1.5.,
  - b) *backflow preventers* required by Sentence 2.6.2.1.(3), and
  - c) pressure-reducing valves required by Article 2.6.3.3.
- (See Note A-2.6.1.11.(1).)

**2.6.1.12. Service Water Heaters**

**1)** Thermostat controls for electric *storage-type service water heaters* shall be set at a temperature of 60°C. (See Note A-2.6.1.12.(1).)

**2.6.2. Protection from Contamination****2.6.2.1. Connection of Systems**

**1)** Except as provided in Sentence (2), connections to *potable water systems* shall be designed and installed so that non-*potable* water or substances that may render the water non-*potable* cannot enter the system.

**2)** A water treatment device or apparatus shall not be installed unless it can be demonstrated that the device or apparatus will not introduce substances into the system that may endanger health.

**3)** *Backflow preventers* shall be selected and installed in conformance with CSA B64.10, "Selection and installation of backflow preventers."

**2.6.2.2. Back-Siphonage**

**1)** *Potable* water connections to *fixtures*, tanks, vats or other devices not subject to pressure above atmospheric and containing other than *potable* water shall be installed so as to prevent *back-siphonage* in conformance with Sentence (2).

**2)** Except as provided in Sentence 2.6.2.10.(2), *back-siphonage* shall be prevented by the installation of

- a) an *air gap*,
- b) an atmospheric *vacuum breaker*,
- c) a pressure *vacuum breaker*,
- d) a spill-resistant pressure *vacuum breaker*,
- e) a hose connection *vacuum breaker*,
- f) a dual *check valve backflow preventer* with atmospheric port,
- g) a double *check valve* assembly,
- h) a reduced pressure principle *backflow preventer*,
- i) a dual *check valve backflow preventer*,
- j) a laboratory faucet type *vacuum breaker*, or
- k) a dual *check valve backflow preventer* with vent.

**2.6.2.3. Backflow Caused by Back Pressure**

- 1) *Potable* water connections to *fixtures*, tanks, vats, boilers or other devices containing other than *potable* water and subject to pressure above atmospheric shall be arranged to prevent *backflow* caused by *back pressure* in conformance with Sentences (2) and (3).
- 2) Except as provided in Article 2.6.2.4., *backflow* caused by *back pressure* of non-toxic substances into a *potable water system* shall be prevented by the installation of
  - a) an *air gap*,
  - b) a dual *check valve backflow preventer* with atmospheric port,
  - c) a dual *check valve backflow preventer*,
  - d) a dual *check valve backflow preventer* with vent,
  - e) a double *check valve assembly*, or
  - f) a reduced pressure principle *backflow preventer*.
- 3) *Backflow* caused by *back pressure* of toxic substances into a *potable water system* shall be prevented by the installation of
  - a) an *air gap*, or
  - b) a reduced pressure principle *backflow preventer*.

**2.6.2.4. Backflow from Fire Protection Systems**

- 1) A *backflow preventer* shall not be required in *residential full flow-through fire sprinkler/standpipe systems* in which the pipes and fittings are constructed of *potable water system materials*.
- 2) Except as required by Sentence (4), *potable water system* connections to fire sprinkler and standpipe systems shall be protected against *backflow* caused by *back-siphonage* or *back pressure* in conformance with Clauses (a) to (g), as applicable:
  - a) *residential partial flow-through fire sprinkler/standpipe systems* in which the pipes and fittings are constructed of *potable water system materials* shall be protected by a dual *check valve backflow preventer* conforming to
    - i) CSA B64.6, "Dual check valve (DuC) backflow preventers,"  
or
    - ii) CSA B64.6.1, "Dual check valve backflow preventers for fire protection systems (DuCF),"
  - b) provided that the systems do not use antifreeze or other additives of any kind and that all pipes and fittings are constructed of *potable water system materials*, *Class 1 fire sprinkler/standpipe systems* shall be protected by a single or dual *check valve backflow preventer* conforming to
    - i) CSA B64.6, "Dual check valve (DuC) backflow preventers,"  
or
    - ii) CSA B64.9, "Single check valve backflow preventers for fire protection systems (SCVAF),"
  - c) provided that the systems do not use antifreeze or other additives of any kind, *Class 1 fire sprinkler/standpipe systems* not covered by Clause (b) as well as *Class 2 and Class 3 fire sprinkler/standpipe systems* shall be protected by a double *check valve backflow preventer* conforming to
    - i) CSA B64.5, "Double check valve (DCVA) backflow preventers," or
    - ii) CSA B64.5.1, "Double check valve backflow preventers for fire protection systems (DCVAF),"
  - d) *Class 1, Class 2 and Class 3 fire sprinkler/standpipe systems* in which antifreeze or other additives are used shall be protected by a reduced pressure principle *backflow preventer* conforming to
    - i) CSA B64.4, "Reduced pressure principle (RP) backflow preventers," or
    - ii) CSA B64.4.1, "Reduced pressure principle backflow preventers for fire protection systems (RPF),"installed on the portion of the system that uses the additives and the balance of the system shall be protected as required by Clause (b) or (c),

- e) *Class 4 and Class 5 fire sprinkler/standpipe systems* shall be protected by a reduced pressure principle *backflow preventer* conforming to
    - i) CSA B64.4, "Reduced pressure principle (RP) backflow preventers," or
    - ii) CSA B64.4.1, "Reduced pressure principle backflow preventers for fire protection systems (RPF),"
  - f) *Class 6 fire sprinkler/standpipe systems* shall be protected by a double *check valve backflow preventer* conforming to
    - i) CSA B64.5, "Double check valve (DCVA) backflow preventers," or
    - ii) CSA B64.5.1, "Double check valve backflow preventers for fire protection systems (DCVAF)," or
  - g) where a potentially severe health hazard may be caused by *backflow*, *Class 6 fire sprinkler/standpipe systems* shall be protected by a reduced pressure principle *backflow preventer* conforming to
    - i) CSA B64.4, "Reduced pressure principle (RP) backflow preventers," or
    - ii) CSA B64.4.1, "Reduced pressure principle backflow preventers for fire protection systems (RPF)."
- (See Note A-2.6.2.4.(2).)

**3)** *Backflow preventers* required by Sentence (2) shall be installed upstream of the fire department pumper connection. (See Note A-2.6.2.4.(3).)

**4)** Where a reduced pressure principle *backflow preventer* is required on a *water service pipe* at a fire service connection located on the same premises as the *fire service pipe* in *Class 3, 4, 5 and 6 fire sprinkler/standpipe systems*, a reduced pressure principle *backflow preventer* conforming to CSA B64.4.1, "Reduced pressure principle backflow preventers for fire protection systems (RPF)," shall also be required on the fire service connection.

### 2.6.2.5. Separation of Water Supply Systems

**1)** Where a *private water supply system* or a *non-potable water system* is supplied by a public water supply system, the public water supply system shall be protected in accordance with Article 2.6.2.1.

### 2.6.2.6. Premise Isolation

**1)** In addition to the *backflow preventer* required by this Subsection for *buildings* or facilities where a potentially severe health hazard may be caused by *backflow*, the *potable water system* shall be provided with premise isolation by the installation of a reduced pressure principle *backflow preventer*. (See Note A-2.6.2.6.(1).)

### 2.6.2.7. Hose Bibb

**1)** Where a hose bibb is installed outside a *building*, inside a garage or in an area where there is an identifiable risk of contamination, the *potable water system* shall be protected against *backflow* through the hose bibb.

### 2.6.2.8. Cleaning of Systems

**1)** A newly installed part of a *potable water system* shall be cleaned and then flushed with *potable water* before the system is put into operation.

### 2.6.2.9. Air Gap

- 1)** *Air gaps* shall not be located in a noxious environment.
- 2)** *Air gaps* shall be not less than 25 mm high and at least twice the diameter of the opening of the water supply outlet in height. (See Note A-2.6.2.9.(2).)

**2.6.2.10. Vacuum Breakers**

**1)** Where the *critical level* is not marked on an atmospheric *vacuum breaker*, pressure *vacuum breaker*, or spill-resistant pressure *vacuum breaker*, the *critical level* shall be taken as the lowest point on the device.

**2)** Where an atmospheric *vacuum breaker* is installed, it shall be located on the downstream side of the *fixture* control valve or faucet so that it will be subject to water supply pressure

- a) only when the valve or faucet is open, and
- b) for periods of continuous use not exceeding 12 h.

(See Note A-2.6.2.10.(2).)

**3)** An atmospheric *vacuum breaker* shall be installed so that the *critical level* is at least the distance specified by the manufacturer for safe operation of the device, but not less than 25 mm above

- a) the *flood level rim* of a *fixture* or tank, or
- b) the highest point open to the atmosphere in an irrigation system.

**4)** A pressure *vacuum breaker* or spill-resistant pressure *vacuum breaker* shall be installed so that the *critical level* is not less than 300 mm above

- a) the *flood level rim* of a *fixture* or tank, or
- b) the highest point open to the atmosphere in an irrigation system.

**2.6.2.11. Tank-Type Water Closets**

**1)** Tank-type water closets shall be provided with a *back-siphonage preventer* in conformance with Sentence 2.2.10.10.(2).

**2.6.2.12. Backflow Preventers**

**1)** No bypass piping or other device capable of reducing the effectiveness of a *backflow preventer* shall be installed in a water supply system.

**2.6.3. Size and Capacity of Pipes**

(See Note A-2.6.3.)

**2.6.3.1. Design, Fabrication and Installation**

(See Note A-2.6.3.1.)

**1)** *Water distribution systems* shall be designed to provide peak demand flow when the flow pressures at the supply openings conform to the plumbing supply fitting manufacturer's specifications.

**2)** *Potable water systems* shall be designed, fabricated and installed in accordance with good engineering practice, such as that described in the ASHRAE Handbooks and ASPE Plumbing Engineering Design Handbooks. (See Note A-2.6.3.1.(2).)

**3)** In one- and two-family *dwelling units* and manufactured homes, multi-purpose systems that combine *potable water systems* and residential fire sprinkler systems shall be designed, fabricated and installed in accordance with NFPA 13D, "Standard for the Installation of Sprinkler Systems in One- and Two-Family Dwellings and Manufactured Homes."

**2.6.3.2. Hydraulic Load**

**1)** Except as provided in Sentence (3), the hydraulic load of a *fixture* or device that is listed in Table 2.6.3.2.-A shall be the number of *fixture units* given in the Table.

**2)** Except as provided in Sentences (1) and (3), the hydraulic load of a *fixture* that is not listed in Table 2.6.3.2.-A is the number of *fixture units* listed in Table 2.6.3.2.-D.

**3)** Where *fixtures* are supplied with both hot and cold water, the hydraulic loads for maximum separate demands shall be 75% of the hydraulic load of the *fixture units* given in Tables 2.6.3.2.-A and 2.6.3.2.-D when using a detailed engineering design method.

4) The hydraulic load of urinals and water closets with direct flush valves shall be the number of *fixture units* listed in Tables 2.6.3.2.-B and 2.6.3.2.-C. (See Note A-2.6.3.2.(4).)

**Table 2.6.3.2.-A**  
**Sizing of Water Distribution Systems<sup>(1)(2)</sup>**  
 Forming Part of Sentences 2.6.3.2.(1), (2) and (3), and 2.6.3.4.(2), (3) and (5)

Fixture or Device	Minimum Nominal Pipe Size of Supply Pipe, NPS	Private Use Hydraulic Load, fixture units			Public Use Hydraulic Load, fixture units		
		Cold	Hot	Total	Cold	Hot	Total
Bathroom group with 6 LPF flush tank <sup>(3)</sup>	n/a	2.7	1.5	3.6	n/a	n/a	n/a
Bathroom group with greater than 6 LPF flush tank <sup>(3)</sup>	n/a	4	3	6	n/a	n/a	n/a
Bathroom group with more than 3 fixtures	n/a	n/a	n/a	<sup>(4)</sup>	n/a	n/a	n/a
Bathtub with or without shower head	½	1	1	1.4	3	3	4
Bathtub with NPS ¾ spout	¾	7.5	7.5	10	7.5	7.5	10
Bedpan washer	1	n/a	n/a	n/a	7.5	7.5	10
Bidet	⅜	1.5	1.5	2	n/a	n/a	n/a
Clothes washer 3.5 kg	½	1	1	1.4	2.25	2.25	3
Clothes washer 6.8 kg	½	n/a	n/a	n/a	3	3	4
Clothes washer, commercial <sup>(5)</sup>	n/a	n/a	n/a	n/a	n/a	n/a	n/a
Dental lavatory	⅜	n/a	n/a	n/a	1.5	1.5	2
Dental unit, cuspidor	⅜	n/a	n/a	n/a	1	n/a	1
Dishwasher, commercial <sup>(5)</sup>	n/a	n/a	n/a	n/a	n/a	n/a	n/a
Dishwasher, domestic	⅜	n/a	1.4	1.4	n/a	n/a	n/a
Drinking fountain or water cooler	⅜	n/a	n/a	n/a	0.25	n/a	0.25
Hose bibb	½	2.5	n/a	2.5	2.5	n/a	2.5
Hose bibb	¾	3	n/a	3	6	n/a	6
Hose bibb, combination hot and cold	½	1.9	1.9	2.5	1.9	1.9	2.5
Lavatory, 8.3 LPM or less	⅜	0.5	0.5	0.7	1.5	1.5	2
Lavatory, greater than 8.3 LPM	⅜	0.75	0.75	1	1.5	1.5	2
Sink, bar	⅜	0.75	0.75	1	1.5	1.5	2
Sink, clinic service faucet	½	n/a	n/a	n/a	2.25	2.25	3
Sink, clinic service with direct flush valve	1	n/a	n/a	n/a	6	n/a	6
Sink, kitchen commercial, per faucet	½	n/a	n/a	n/a	3	3	4
Sink, kitchen domestic, 8.3 LPM	⅜	1	1	1.4	1	1	1.4
Sink, kitchen domestic, greater than 8.3 LPM	⅜	1.5	1.5	2	1.5	1.5	2
Sink, laboratory	⅜	n/a	n/a	n/a	1.5	1.5	2
Sink, laundry (1 or 2 compartments)	⅜	1	1	1.4	1	1	1.4
Sink, service or mop basin	½	n/a	n/a	n/a	2.25	2.25	3
Sink, washup, per faucet	½	n/a	n/a	n/a	1.5	1.5	2
Shower head, 9.5 LPM or less per head	½	1	1	1.4	3	3	4
Shower head, greater than 9.5 LPM per head	½	1.5	1.5	2	3	3	4
Shower, spray, multi-head, <i>fixture unit</i> per head	<sup>(5)</sup>	1	1	1.4	3	3	4
Urinal, with direct flush valve	¾	<sup>(6)</sup>	n/a	<sup>(6)</sup>	<sup>(6)</sup>	n/a	<sup>(6)</sup>
Urinal, with flush tank	⅜	3	n/a	3	3	n/a	3
Urinal, with self-closing metering valve	½	2	n/a	2	4	n/a	4
Water closet, 6 LPF or less with flush tank	⅜	2.2	n/a	2.2	2.2	n/a	2.2

**Table 2.6.3.2.-A (Continued)**

Fixture or Device	Minimum Nominal Pipe Size of Supply Pipe, NPS	Private Use Hydraulic Load, fixture units			Public Use Hydraulic Load, fixture units		
		Cold	Hot	Total	Cold	Hot	Total
Water closet, greater than 6 LPF with flush tank	3/8	3	n/a	3	5	n/a	5
Water closet, with direct flush valve	1	(6)	n/a	(6)	(6)	n/a	(6)

**Notes to Table 2.6.3.2.-A:**

- (1) The *fixture unit* values in this Table are not applicable in certain assembly *occupancies* because of surges in use by the occupants. For such *occupancies*, refer to specific design information.
- (2) For *fixtures* not indicated in this Table, refer to Table 2.6.3.2.-D.
- (3) *Bathroom group* is based on an NPS 1/2 bathtub supply pipe.
- (4) Add additional *fixture* to the *fixture* load for *bathroom group*.
- (5) Refer to manufacturer's recommendations.
- (6) For *fixture unit* values for *fixtures* with direct flush valves, see Sentence 2.6.3.2.(4) and Tables 2.6.3.2.-B and 2.6.3.2.-C.

**Table 2.6.3.2.-B**  
**Sizing of Water Distribution Systems for Urinals with Direct Flush Valves**  
 Forming Part of Sentences 2.6.3.2.(4) and 2.6.3.4.(5)

Number of Valves	Individual <i>Fixture Unit</i> Assigned in Decreasing Values	<i>Fixture Units</i> in Accumulative Values <sup>(1)</sup>
1	20	20
2	15	35
3	10	45
4	8	53
5 or more	5 each	58, plus 5 for each additional <i>fixture</i> in excess of 5

**Notes to Table 2.6.3.2.-B:**

- (1) The accumulative *fixture unit* values are the total values to be used in conjunction with Table 2.6.3.2.-A.

**Table 2.6.3.2.-C**  
**Sizing of Water Distribution Systems for Water Closets with Direct Flush Valves**  
 Forming Part of Sentences 2.6.3.2.(4) and 2.6.3.4.(5)

Number of Valves	Individual <i>Fixture Unit</i> Assigned in Decreasing Values	<i>Fixture Units</i> in Accumulative Values <sup>(1)</sup>
1	40	40
2	30	70
3	20	90
4	15	105
5 or more	10 for each <i>public use</i> and 6 for each <i>private use</i>	115, plus 10 for each <i>public use</i> additional <i>fixture</i> in excess of 5 and 111, plus 6 for each <i>private use</i> additional <i>fixture</i> in excess of 5

**Notes to Table 2.6.3.2.-C:**

- (1) The accumulative *fixture unit* values are the total values to be used in conjunction with Table 2.6.3.2.-A.

**Table 2.6.3.2.-D**  
**Hydraulic Loads of Fixtures Not Listed in Table 2.6.3.2.-A**  
 Forming Part of Sentences 2.6.3.2.(2) and (3) and 2.6.3.4.(5)

Nominal Pipe Size of Supply Pipe, NPS	Hydraulic Load, fixture units	
	Private Use	Public Use
3/8	1	2
1/2	2	4
3/4	3	6
1	6	10

### 2.6.3.3. Static Pressure

**1)** Where the static pressure at any *fixture* may exceed 550 kPa, a pressure-reducing valve shall be installed to limit the maximum static pressure at the *fixture* to 550 kPa.

### 2.6.3.4. Size

**1)** *Water service pipes* shall be sized according to the peak demand flow but shall not be less than NPS 3/4.

**2)** Except as provided in Sentence (3), the *nominal pipe size* of a supply pipe that serves a *fixture* shall conform to Table 2.6.3.2.-A.

**3)** For *fixtures* listed in Table 2.6.3.2.-A that are permitted to have an NPS 3/8 supply pipe, a connector not more than 750 mm long and not less than NPS 1/4 may be used to supply water to the *fixture*.

**4)** No *water system* between the point of connection with the *water service pipe* or the water meter and the first water distribution pipe that supplies a water heater that serves more than one *fixture* shall be sized less than NPS 3/4.

**5)** Where both hot and cold water is supplied to *fixtures* in residential buildings containing one or two *dwelling units* or row houses with separate *water service pipes*, the *water system* may be sized in accordance with Table 2.6.3.4., where

- the hydraulic loads for maximum separate demands on *water distribution system* piping are not less than 100% of the total hydraulic load of the *fixture units* given in Table 2.6.3.2.-A, 2.6.3.2.-B, 2.6.3.2.-C or 2.6.3.2.-D for *private use*,
- the minimum water pressure at the entry to the *building* is 200 kPa, and
- the total maximum length of the *water system* is 90 m.

(See Note A-2.6.3.4.(5).)

**Table 2.6.3.4.**  
**Water Pipe Sizing for Buildings Containing One or Two Dwelling Units or Row Houses with Separate Water Service Pipes**  
 Forming Part of Sentence 2.6.3.4.(5)

Nominal Pipe Size of Water Pipe, NPS	Water Velocity, m/s <sup>(1)</sup>		
	3.0	2.4	1.5
	Hydraulic Load, fixture units		
1/2	8	7	4
3/4	21	16	9
1	43	31	18
1 1/4	83	57	30

#### Notes to Table 2.6.3.4.:

<sup>(1)</sup> Table 2.6.3.4. is not intended to limit water velocities that are permitted by Sentence 2.6.3.5.(1).

**2.6.3.5. Velocity**

1) The maximum permitted water velocities shall be those recommended by the pipe and fitting manufacturer.

## Section 2.7. Non-Potable Water Systems

**2.7.1. Non-Potable Water Systems****2.7.1.1. General**

(See Note A-2.7.1.1.)

1) *Non-potable water systems* shall be designed, fabricated and installed in accordance with this Subsection and good engineering practice. (See Note A-2.7.1.1.(1).)

2) Except as provided in Sentence (3) and Subsection 2.7.2., *non-potable water systems* shall only be used to supply water closets, urinals, *trap* seal primers, and *directly connected* underground irrigation systems that only dispense water below the surface of the ground.

3) *Non-potable water systems* shall not be used to supply *fixtures* in healthcare facilities.

4) Where a *non-potable water system* is supplied by a *potable water system*, the *potable water system* shall be protected in accordance with Article 2.6.2.1.

5) Where the static pressure at any *fixture* in a *non-potable water system* may exceed 550 kPa, a pressure-reducing valve shall be installed to limit the maximum static pressure at the *fixture* to 550 kPa.

**2.7.1.2. Identification and Marking**

1) *Non-potable water piping and outlets* shall be identified and marked in accordance with CAN/CSA-B128.1, "Design and Installation of Non-Potable Water Systems."

**2.7.1.3. Location of Pipes**

- 1) *Non-potable water piping* shall not be located directly above
- areas where food, drink or products that are intended for human consumption are prepared, handled, dispensed or stored, or
  - a non-pressurized or pressurized *potable water tank*.

**2.7.1.4. Location of Outlets**

- 1) Except as provided in Subsection 2.7.2., an outlet from a *non-potable water system* shall not be located where it can discharge into
- a *fixture* into which an outlet from a *potable water system* is discharged, or
  - a *fixture* that is used for the preparation, handling or dispensing of food, drink or products that are intended for human consumption.

**2.7.2. Non-Potable Rainwater Harvesting Systems****2.7.2.1. General**

1) For the purposes of this Subsection, rainwater shall mean *storm water* discharged from an above-ground roof surface. (See Note A-2.7.2.1.(1).)

2) For the purposes of this Subsection, a *non-potable rainwater harvesting system* shall mean a storage tank, a pump, pipes, fittings and other plumbing appurtenances used to collect and distribute rainwater, but shall not include a rain barrel not connected to a *plumbing system*.



**2.7.2.2. Permitted Applications**

- 1) Non-*potable* rainwater harvesting systems are only permitted to supply
  - a) water closets and urinals,
  - b) clothes washers,
  - c) floor-mounted service sinks and laundry trays,
  - d) *trap* primers,
  - e) irrigation systems,
  - f) hydronic systems,
  - g) make-up water systems for heat rejection systems, or
  - h) any other application where the harvested rainwater is not expected to be ingested or inhaled.

(See Note A-2.7.2.2.(1) and 2.7.2.4.(3) and (4).)

**2.7.2.3. Roof Design**

1) Roof surfaces that supply rainwater to a non-*potable* rainwater harvesting system shall be inaccessible to vehicular and pedestrian traffic. (See Note A-2.7.2.3.(1).)

2) Roofing components and conveyance systems in contact with rainwater that is supplied to a non-*potable* rainwater harvesting system shall be constructed of materials that will not introduce substances into the rainwater that could adversely affect its intended end use. (See Note A-2.7.2.3.(2).)

**2.7.2.4. Non-Potable Rainwater Harvesting System Design**

1) Non-*potable* rainwater harvesting systems and their connections shall be designed, fabricated and installed in accordance with this Subsection and good engineering practice. (See Note A-2.7.2.4.(1).)

2) Non-*potable* rainwater harvesting systems shall not collect water discharged from an evaporative heat rejection system.

3) Non-*potable* rainwater harvesting systems shall be provided with a means to treat the harvested rainwater in such a manner that the quality of the delivered non-*potable* water conforms to appropriate provincial or territorial requirements or, in the absence of such requirements, the systems shall conform to Sentence (4). (See Note A-2.7.2.2.(1) and 2.7.2.4.(3) and (4).)

4) Except as provided in Sentence (3), non-*potable* rainwater harvesting systems shall be provided with

- a) a water treatment system consisting of
  - i) a debris screen with a mesh size of not more than 6 mm ahead of the storage tank inlet,
  - ii) a first-flush diversion system with a capacity of not less than 0.3 L/m<sup>2</sup> of roof area ahead of the storage tank inlet,
  - iii) a calming inlet or settling chamber ahead of the storage tank inlet,
  - iv) a device to prevent the entrainment of sediment into the pump, and
  - v) where the harvested rainwater is used for an indoor application, a filter with a mesh size of not more than 50 µm ahead of the storage tank inlet, or
- b) a means to treat the harvested rainwater in such a manner that the delivered non-*potable* water contains not more than the maximum acceptable levels of contaminants stated in CSA B805/ICC 805, "Rainwater harvesting systems."

(See Note A-2.7.2.2.(1) and 2.7.2.4.(3) and (4).)

5) Where the static pressure at any *fixture* in a non-*potable* rainwater harvesting system may exceed 550 kPa, a pressure-reducing valve shall be installed to limit the maximum static pressure at the *fixture* to 550 kPa.

- 6)** Storage tanks in non-potable rainwater harvesting systems shall be designed and installed in accordance with
  - a) CAN/CSA-B126.0, "General requirements and methods of testing for water cisterns," and
  - b) CAN/CSA-B126.1, "Installation of water cisterns."
- 7)** Storage tanks in non-potable rainwater harvesting systems shall be equipped with an overflow that directs excess rainwater to
  - a) a public storm sewer,
  - b) a public combined sewer,
  - c) a storm water management system, or
  - d) a designated storm water disposal location.
- 8)** Where the storage tank outlet is located below the level of the adjoining street, the storage tank overflow required by Sentence (7) shall
  - a) terminate with an indirect connection that is not located within the building, or
  - b) be equipped with a backwater valve.
- 9)** Make-up water connections to non-potable rainwater harvesting systems shall
  - a) be equipped with a reduced pressure principle backflow preventer, or
  - b) have an air gap.
- 10)** Where a fixture combines water from a non-potable rainwater harvesting system and potable water at the fixture supply fitting, the potable water system shall be protected by a backflow preventer as described in Sentence 2.6.2.1.(3).

## Section 2.8. Objectives and Functional Statements

### 2.8.1. Objectives and Functional Statements

#### 2.8.1.1. Attribution to Acceptable Solutions

**1)** For the purposes of compliance with this Code as required in Clause 1.2.1.1.(1)(b) of Division A, the objectives and functional statements attributed to the acceptable solutions in this Part shall be the objectives and functional statements listed in Table 2.8.1.1. (See Note A-1.1.2.1.(1).)

**Table 2.8.1.1.**  
**Objectives and Functional Statements Attributed to the**  
**Acceptable Solutions in Part 2**  
 Forming Part of Sentence 2.8.1.1.(1)

Provision	Functional Statements and Objectives <sup>(1)</sup>
<b>2.1.2.1. Sanitary Drainage Systems</b>	
(1)	[F72-OH2.1]
(2)	[F72-OH2.1] [F72-OP5]
<b>2.1.2.2. Storm Drainage Systems</b>	
(1)	[F72-OP5]
<b>2.1.2.3. Water Distribution Systems</b>	
(1)	[F46-OH2.2]
<b>2.1.2.4. Separate Services</b>	
(1)	[F71-OH2.1,OH2.3] [F70-OH2.1]
<b>2.1.3.1. Lighting and Ventilation Requirements</b>	
(1)	[F40-OH1.1] Applies to the requirement for ventilation. [F30-OS3.1] Applies to the requirement for lighting.

**Table 2.8.1.1. (Continued)**

Provision	Functional Statements and Objectives <sup>(1)</sup>
<b>2.1.3.2. Accessibility</b>	
(1)	[F40-OH2.1] [F41-OH2.4] [F71-OH2.3] [F82-OH2.1,OH2.2,OH2.3,OH2.4] [F71-OH2.3] [F81-OH2.4] [F81-OP5]
<b>2.1.4.1. Seismic Restraints and Design</b>	
(1)	[F20-OS2.1]
<b>2.2.1.1. Exposure of Materials</b>	
(1)	[F80-OH2.1,OH2.2,OH2.3,OH2.4] [F80-OP5]
(2)	[F80-OH2.1] [F80-OP5]
<b>2.2.1.2. Restrictions on Re-Use</b>	
(1)	[F70-OH2.2]

Table 2.8.1.1. (Continued)

Provision	Functional Statements and Objectives <sup>(1)</sup>
<b>2.2.1.5. Withstanding Pressure</b>	
(1)	[F20,F81-OH2.1,OH2.3] [F46-OH2.2] [F20-OP5]
<b>2.2.1.6. Working Pressure of a Water Service Pipe</b>	
(1)	[F20,F81-OH2.3] [F20-OP5]
<b>2.2.2.1. Surface Requirements</b>	
(1)	[F41-OH2.4]
<b>2.2.2.2. Conformance to Standards</b>	
(1)	[F80-OH2.1,OH2.4] [F80-OS3.1,OS3.2]
<b>2.2.2.3. Showers</b>	
(1)	[F80-OH2.1] [F80-OP5]
(2)	[F80-OH2.1] [F40-OP5]
(3)	[F45-OH2.1]
(4)	[F45-OH2.1]
<b>2.2.2.4. Concealed Overflows</b>	
(1)	[F41,F81-OH2.1,OH2.4]
<b>2.2.2.5. Water Closets in Public Washrooms</b>	
(1)	[F30-OH2.1,OH2.4]
<b>2.2.3.1. Traps</b>	
(1)	[F81,F40-OH1.1]
(2)	[F81-OH1.1] [F81-OP5]
(3)	[F81-OH2.1,OH2.3,OH2.4] [F81-OP5]
(4)	[F81-OH1.1]
(5)	[F81-OH1.1]
<b>2.2.3.2. Interceptors</b>	
(1)	[F81-OH2.1,OH2.3,OH2.4]
(2)	[F81-OH2.1,OH2.3,OH2.4] [F46-OH2.2]
(3)	[F81-OH2.1] [F81-OP5]
<b>2.2.3.3. Tubular Traps</b>	
(1)	[F82-OH2.1,OH2.4] [F82-OP5]
<b>2.2.4.1. T and Cross Fittings</b>	
(1)	[F81-OH2.1,OH2.4]
(2)	[F81-OH2.1,OH2.4]
<b>2.2.4.2. Sanitary T Fittings</b>	
(1)	[F81-OH2.1,OH2.4]

Table 2.8.1.1. (Continued)

Provision	Functional Statements and Objectives <sup>(1)</sup>
(2)	[F81-OH2.1,OH2.4] [F81-OP5]
<b>2.2.4.3. 90° Elbows</b>	
(1)	[F81-OH2.1,OH2.4]
(2)	[F81-OH2.1,OH2.4]
<b>2.2.5.1. Fibrocement Pipe and Fittings</b>	
(1)	[F20-OH2.1] [F20-OP5]
<b>2.2.5.2. Concrete Pipe and Fittings</b>	
(1)	[F20-OH2.1]
(2)	[F20-OH2.1]
(3)	[F20-OH2.1]
(4)	[F20-OH2.1]
(5)	[F20-OH2.1]
<b>2.2.5.3. Vitrified Clay Pipe and Fittings</b>	
(1)	[F20-OH2.1]
(2)	[F20-OH2.1]
(3)	[F20-OH2.1]
<b>2.2.5.4. Polyethylene Pipe and Fittings</b>	
(1)	[F20-OH2.1,OH2.2,OH2.3] [F20-OP5]
(2)	[F20-OP5]
(3)	[F20-OP5]
<b>2.2.5.5. Polyethylene Pipe Used Underground</b>	
(1)	[F72-OH2.1,OH2.3]
<b>2.2.5.6. Crosslinked Polyethylene Pipe and Fittings</b>	
(1)	[F20-OH2.2] [F20-OP5]
<b>2.2.5.7. PVC Pipe and Fittings</b>	
(1)	[F20-OH2.1,OH2.2,OH2.3] [F20-OP5]
(2)	[F20-OH2.1,OH2.2,OH2.3] [F20-OP5]
(3)	[F20-OH2.1,OH2.2,OH2.3] [F20-OP5]
(4)	[F20-OP5]
<b>2.2.5.8. CPVC Pipe, Fittings and Solvent Cements</b>	
(1)	[F20-OH2.2,OH2.3,OH2.4] [F20-OP5]
(2)	[F20-OP5]

**Table 2.8.1.1. (Continued)**

Provision	Functional Statements and Objectives <sup>(1)</sup>
<b>2.2.5.9. Plastic Pipe, Fittings and Solvent Cement Used Underground</b>	
(1)	[F20,F80,F81-OH2.1] [F20,F80,F81-OP5]
<b>2.2.5.10. Transition Solvent Cement</b>	
(1)	[F20,F80,F81-OH2.1,OH2.3]
(2)	[F20,F80,F81-OH2.1,OH2.3]
<b>2.2.5.11. Plastic Pipe, Fittings and Solvent Cement Used in Buildings</b>	
(1)	[F20,F80,F81-OH2.1,OH2.3]
<b>2.2.5.12. Polyethylene/Aluminum/Polyethylene Composite Pipe and Fittings</b>	
(1)	[F20,F80,F81-OH2.1,OH2.2,OH2.3] [F20-OP5]
(2)	[F20-OP5] [F20-OH2.1,OH2.2,OH2.3]
(3)	[F20-OP5] [F20-OH2.1,OH2.2,OH2.3]
(4)	[F20-OP5] [F20-OH2.1,OH2.2,OH2.3]
<b>2.2.5.13. Crosslinked Polyethylene/Aluminum/Crosslinked Polyethylene Composite Pressure Pipe and Fittings</b>	
(1)	[F20-OH2.1,OH2.2,OH2.3] [F20-OP5]
<b>2.2.5.14. Polypropylene Pipe and Fittings</b>	
(1)	[F20-OH2.1,OH2.2,OH2.3] [F20-OP5]
<b>2.2.5.15. Polyethylene of Raised Temperature Tube and Fittings</b>	
(1)	[F20,F70,F80-OH2.2] [F20,F70,F80-OP5]
(2)	[F80,F81-OH2.1] [F20,F70,F80-OP5]
<b>2.2.5.16. Cellular Core PVC Pipe and Fittings</b>	
(1)	[F20-OH2.1,OH2.2,OH2.3] [F20-OP5]
(2)	[F20-OH2.1] [F20-OP5]
<b>2.2.6.1. Cast-Iron Drainage and Vent Pipe and Fittings</b>	
(1)	[F20-OH2.1,OH2.3]
(2)	[F20-OH2.2]
<b>2.2.6.2. Maintenance Holes and Catch Basins</b>	
(1)	[F81-OH1.1] [F20-OS3.1]

**Table 2.8.1.1. (Continued)**

Provision	Functional Statements and Objectives <sup>(1)</sup>
<b>2.2.6.3. Threaded Cast-Iron Drainage Fittings</b>	
(1)	[F20-OH2.1,OH2.3]
(2)	[F20-OP5]
<b>2.2.6.4. Cast-Iron Water Pipes</b>	
(1)	[F20-OP5] [F20-OH2.1,OH2.2,OH2.3]
(2)	[F80-OH2.2]
(3)	[F20-OP5]
(4)	[F20-OP5]
<b>2.2.6.5. Screwed Cast-Iron Water Fittings</b>	
(1)	[F20-OP5]
(2)	[F80-OH2.2]
(3)	[F81-OH2.1,OH2.3]
<b>2.2.6.6. Screwed Malleable-Iron Water Fittings</b>	
(1)	[F81-OP5]
(2)	[F80-OH2.2]
(3)	[F81-OH2.1,OH2.3]
<b>2.2.6.7. Steel Pipe</b>	
(1)	[F80-OH2.1,OH2.3] [F46-OH2.2]
(3)	[F46-OH2.2]
(4)	[F80-OH2.1,OH2.3] [F80-OP5]
<b>2.2.6.8. Corrugated Steel Pipe and Couplings</b>	
(1)	[F80-OP5]
(2)	[F81-OP5]
(3)	[F81-OP5]
<b>2.2.6.9. Sheet Metal Leaders</b>	
(1)	[F80-OP5]
<b>2.2.6.10. Stainless Steel Pipe</b>	
(1)	[F80-OH2.1] Applies to <i>drainage systems</i> and <i>venting systems</i> . [F46,F80-OH2.2] Applies to <i>water systems</i> . [F80-OP5]
(2)	[F80-OH2.1] Applies to <i>drainage systems</i> and <i>venting systems</i> . [F46,F80-OH2.2] Applies to <i>water systems</i> . [F80-OP5]
<b>2.2.6.11. Stainless Steel Butt Weld Pipe Fittings</b>	
(1)	[F80-OH2.1] Applies to <i>drainage systems</i> and <i>venting systems</i> . [F46,F80-OH2.2] Applies to <i>water systems</i> . [F80-OP5]

Table 2.8.1.1. (Continued)

Provision	Functional Statements and Objectives <sup>(1)</sup>
(2)	[F80-OH2.1] Applies to <i>drainage systems and venting systems</i> . [F46,F80-OH2.2] Applies to <i>water systems</i> . [F80-OP5]
<b>2.2.6.12. Stainless Steel Pipe Flanges</b>	
(1)	[F80-OH2.1] Applies to <i>drainage systems and venting systems</i> . [F46,F80-OH2.2] Applies to <i>water systems</i> . [F80-OP5]
(2)	[F80-OH2.1] Applies to <i>drainage systems and venting systems</i> . [F46,F80-OH2.2] Applies to <i>water systems</i> . [F80-OP5]
<b>2.2.6.13. Stainless Steel Threaded Fittings</b>	
(1)	[F80-OH2.1] Applies to <i>drainage systems and venting systems</i> . [F46,F80-OH2.2] Applies to <i>water systems</i> . [F20-OP5]
(2)	[F80-OH2.1] Applies to <i>drainage systems and venting systems</i> . [F46,F80-OH2.2] Applies to <i>water systems</i> . [F20-OP5]
<b>2.2.6.14. Stainless Steel Tube</b>	
(1)	[F46-OH2.2] [F80-OP5]
(2)	[F46-OH2.2] [F80-OP5]
<b>2.2.6.15. Stainless Steel Pipe and Tube</b>	
(1)	[F80-OH2.1,OH2.2,OH2.3]
<b>2.2.7.1. Copper and Brass Pipe</b>	
(1)	[F80-OH2.1,OH2.3] Applies to <i>drainage systems and venting systems</i> . [F46-OH2.2] Applies to <i>water systems</i> . [F80-OP5]
(2)	[F80-OH2.1,OH2.3] Applies to <i>drainage systems and venting systems</i> . [F46-OH2.2] Applies to <i>water systems</i> . [F80-OP5]
<b>2.2.7.2. Brass or Bronze Pipe Flanges and Flanged Fittings</b>	
(1)	[F80-OH2.1,OH2.3] Applies to <i>drainage systems and venting systems</i> . [F46-OH2.2] Applies to <i>water systems</i> . [F80-OP5]
<b>2.2.7.3. Brass or Bronze Threaded Water Fittings</b>	
(1)	[F80-OP5]
(2)	[F80-OH2.1,OH2.3]

Table 2.8.1.1. (Continued)

Provision	Functional Statements and Objectives <sup>(1)</sup>
<b>2.2.7.4. Copper Tube</b>	
(1)	[F80-OH2.1,OH2.3] Applies to <i>drainage systems and venting systems</i> . [F46-OH2.2] Applies to <i>water systems</i> . [F80-OP5]
(2)	[F80-OH2.1,OH2.2,OH2.3]
(3)	[F80-OH2.1,OH2.3,OH2.4]
<b>2.2.7.5. Solder-Joint Drainage Fittings</b>	
(1)	[F80-OH2.1,OH2.4]
(2)	[F20-OP5]
<b>2.2.7.6. Solder-Joint Water Fittings</b>	
(1)	[F20-OP5]
(2)	[F20-OP5]
<b>2.2.7.7. Flared-Joint Fittings for Copper Water Systems</b>	
(1)	[F20-OP5]
(2)	[F20-OP5]
<b>2.2.7.8. Lead Waste Pipe and Fittings</b>	
(1)	[F46,F20-OH2.2,OH2.3]
(2)	[F81-OH2.1,OH2.3,OH2.4]
<b>2.2.8.1. Pipes and Fittings</b>	
(1)	[F80,F81-OH2.1] [F80,F81-OS3.2,OS3.4]
<b>2.2.9.1. Cement Mortar</b>	
(1)	[F80-OP5] [F80-OH2.1,OH2.3]
<b>2.2.9.2. Solders and Fluxes</b>	
(1)	[F80-OP5] [F80-OH2.1,OH2.3]
(2)	[F46-OH2.2]
(3)	[F80-OH2.1,OH2.3]
(4)	[F20,F80,F81-OH2.1,OH2.3]
<b>2.2.10.1. Brass Floor Flanges</b>	
(1)	[F80-OH2.1]
<b>2.2.10.2. Screws, Bolts, Nuts and Washers</b>	
(1)	[F80-OH2.1,OH2.3]
<b>2.2.10.3. Cleanout Fittings</b>	
(1)	[F80-OH2.1,OH2.3] Applies to <i>drainage systems</i> . [F46-OH2.2] Applies to <i>water systems</i> .
(2)	[F80-OH2.1]
<b>2.2.10.4. Mechanical Couplings</b>	
(1)	[F80-OP5]
(2)	[F80-OH2.1,OH2.3]

**Table 2.8.1.1. (Continued)**

Provision	Functional Statements and Objectives <sup>(1)</sup>
<b>2.2.10.5. Saddle Hubs</b>	
(1)	[F81-OH2.1,OH2.3] [F81-OP5]
<b>2.2.10.6. Valves, and Supply and Waste Fittings</b>	
(1)	[F80-OP5]
(2)	[F131-OE1.2]
(3)	[F30-OS3.1] [F31-OS3.2]
(4)	[F131-OE1.2]
(5)	[F131-OE1.2]
(6)	[F80-OH2.1,OH2.3]
(7)	[F81-OP5] [F46-OH2.2]
<b>2.2.10.7. Water Temperature Control</b>	
(1)	[F31-OS3.2]
(4)	[F31-OS3.2]
(5)	[F31-OS3.2]
<b>2.2.10.8. Direct Flush Valves</b>	
(1)	[F81-OH2.1] (a),(b),(e) [F81-OP5]
<b>2.2.10.9. Drinking Fountain Bubblers</b>	
(1)	[F40,F46-OH2.4]
(2)	[F41,F46-OH2.2]
(3)	[F41,F46-OH2.2]
<b>2.2.10.10. Back-Siphonage Preventers and Backflow Preventers</b>	
(1)	[F46-OH2.2]
(2)	[F46-OH2.2]
<b>2.2.10.11. Relief Valves</b>	
(1)	[F31-OS3.2] [F31-OP5]
<b>2.2.10.12. Reducing Valves</b>	
(1)	[F81-OP5]
<b>2.2.10.13. Solar Domestic Hot Water</b>	
(1)	[F81-OS3.2] [F46-OH2.2] [F80,F81-OP5]
<b>2.2.10.14. Vent Pipe Flashing</b>	
(1)	[F80,F81-OP5]
(2)	[F80,F81-OP5]
<b>2.2.10.15. Water Hammer Arresters</b>	
(1)	[F20,F80-OP5]
<b>2.2.10.16. Air Admittance Valves</b>	
(1)	[F81-OH1.1]

**Table 2.8.1.1. (Continued)**

Provision	Functional Statements and Objectives <sup>(1)</sup>
<b>2.2.10.17. Water Treatment Systems</b>	
(1)	[F46-OH2.2] [F30-OS3.1] [F46,F70-OS3.4] [F20,F30-OS2.1]
<b>2.2.10.18. Flexible Water Connectors</b>	
(1)	[F81-OP5] [F46-OH2.2]
<b>2.3.2.1. Caulked Lead Drainage Joints</b>	
(1)	[F80-OH2.1,OH2.3]
(2)	[F80-OH2.1]
(3)	[F81-OH2.1]
(4)	[F81-OH2.1]
<b>2.3.2.2. Wiped Joints</b>	
(1)	[F80,F81-OH2.1] [F80,F81-OP5]
(2)	[F80,F81-OH2.1,OH2.2,OH2.3]
(3)	[F80,F81-OH2.1,OH2.2,OH2.3]
<b>2.3.2.3. Screwed Joints</b>	
(1)	[F80,F81-OH2.1,OH2.2,OH2.3]
(2)	[F70-OH2.2]
<b>2.3.2.4. Soldered Joints</b>	
(1)	[F20,F81-OH2.1,OH2.2,OH2.3]
<b>2.3.2.5. Flared Joints</b>	
(1)	[F20,F81-OH2.1,OH2.2,OH2.3] [F20,F81-OP5]
(2)	[F20,F81-OH2.1,OH2.2,OH2.3] [F20,F81-OP5]
<b>2.3.2.6. Mechanical Joints</b>	
(1)	[F20-OH2.1,OH2.2,OH2.3] [F20-OP5]
<b>2.3.2.7. Cold-Caulked Joints</b>	
(1)	[F20,F81-OH1.1] Applies to bell and spigot joints in <i>venting systems</i> . [F20,F81-OH2.1,OH2.3] Applies to bell and spigot joints in <i>drainage systems or venting systems</i> . [F20,F81-OP5]
(2)	[F20,F81-OH1.1] [F20,F81-OP5] [F20,F81-OH2.1,OH2.2,OH2.3]
(3)	[F20-OH2.1,OH2.3]
<b>2.3.2.8. Stainless Steel Welded Joints</b>	
(1)	[F20,F81-OH2.1,OH2.2,OH2.3]
(2)	[F20,F81-OH2.1,OH2.2,OH2.3]

Table 2.8.1.1. (Continued)

Provision	Functional Statements and Objectives <sup>(1)</sup>
<b>2.3.3.1. Drilled and Tapped Joints</b>	
(1)	[F81-OH1.1] [F20,F81-OH2.2,OH2.3]
<b>2.3.3.2. Extracted Tees</b>	
(1)	[F81-OH2.1,OH2.3] [F20-OP5]
<b>2.3.3.3. Prohibition of Welding of Pipes and Fittings</b>	
(1)	[F20-OH1.1] [F20-OH2.1,OH2.2,OH2.3]
(2)	[F80-OH2.2] [F80-OP5]
<b>2.3.3.4. Unions and Slip Joints</b>	
(1)	[F81-OH1.1] [F81-OH2.1,OH2.3]
(2)	[F81-OH1.1] [F81-OH2.1,OH2.3]
<b>2.3.3.5. Increaser or Reducer</b>	
(1)	[F81-OH1.1] [F70,F80-OH2.2]
<b>2.3.3.6. Dissimilar Materials</b>	
(1)	[F80-OH1.1] [F80-OP5] [F80-OH2.1]
<b>2.3.3.7. Connection of Roof Drain to Leader</b>	
(1)	[F21,F81-OP5]
<b>2.3.3.8. Connection of Floor or Wall Outlet Fixtures</b>	
(1)	[F80-OH2.1,OH2.3]
(2)	[F80-OH2.1]
(4)	[F20-OH2.1] [F20-OS3.1]
(5)	[F20,F43-OH2.1] [F20,F30-OS3.1]
(6)	[F81-OH2.1]
(7)	[F21-OH2.1]
<b>2.3.3.9. Expansion and Contraction</b>	
(1)	[F21-OH1.1] [F21-OH2.1] [F21-OP5]
<b>2.3.3.10. Copper Tube</b>	
(1)	[F20-OH1.1] [F20-OP5]
<b>2.3.3.11. Indirect Connections</b>	
(1)	[F81-OH2.2,OH2.4]

Table 2.8.1.1. (Continued)

Provision	Functional Statements and Objectives <sup>(1)</sup>
(2)	[F81-OH2.2,OH2.4]
<b>2.3.3.12. Copper Joints Used Underground</b>	
(1)	[F20,F80-OP5]
(2)	[F20,F80-OP5]
<b>2.3.4.1. Capability of Support</b>	
(1)	[F20-OH2.1,OH2.4] [F20-OS3.1] [F20-OP5]
(2)	[F20-OS3.1] [F20-OH2.1,OH2.3]
<b>2.3.4.2. Independence of Support</b>	
(1)	[F20-OS3.1] [F20-OH2.1,OH2.3] [F20-OP5]
<b>2.3.4.3. Insulation of Support</b>	
(1)	[F80-OH2.1,OH2.3] [F80-OS3.1] [F80-OP5]
(2)	[F80-OH2.1,OH2.3] [F80-OS3.1] [F80-OP5]
<b>2.3.4.4. Support for Vertical Piping</b>	
(1)	[F20-OH2.1] [F20-OS3.1]
(2)	[F20-OH2.1] [F20-OS3.1] [F20-OP5]
<b>2.3.4.5. Support for Horizontal Piping</b>	
(1)	[F20-OS3.1] [F20-OH2.1,OH2.3] [F20-OP5]
(2)	[F20-OS3.1] [F20-OH2.1] [F20-OP5]
(3)	[F20-OP5] [F20,F81-OS3.1] [F20-OH2.1]
(4)	[F81-OP5] [F81-OS3.1]
(5)	[F20,F21-OP5] [F20-OS3.1] [F20-OH2.1]

Table 2.8.1.1. (Continued)

Provision	Functional Statements and Objectives <sup>(1)</sup>
(6)	[F20-OP5]
	[F20-OS3.1]
	[F20-OH2.1]
<b>2.3.4.6. Support for Underground Horizontal Piping</b>	
(1)	[F20-OP5]
	[F81-OH2.1]
<b>2.3.4.7. Support for Vent Pipe above a Roof</b>	
(1)	[F81-OS3.1]
	[F81-OP5]
<b>2.3.5.1. Protection of Piping</b>	
(1)	(a) [F81-OP5]
	[F81-OH2.1,OH2.3]
<b>2.3.5.2. Isolation from Loads</b>	
(1)	[F81-OH2.1,OH2.3]
	[F81-OP5]
<b>2.3.5.3. Protection Against Freezing</b>	
(1)	[F81-OP5]
	[F81-OH2.1,OH2.3]
<b>2.3.5.4. Protection from Mechanical Damage</b>	
(1)	[F81-OH2.1,OH2.3]
	[F81-OP5]
<b>2.3.5.5. Protection from Condensation</b>	
(1)	[F81-OP5]
<b>2.3.6.1. Tests and Inspection of Drainage or Venting Systems</b>	
(1)	[F81-OH2.1,OH2.3] Applies to <i>drainage systems</i> .
	[F81-OH1.1] Applies to <i>venting systems</i> .
(2)	[F81-OH1.1] Applies to <i>venting systems</i> .
	[F81-OH2.1,OH2.3] Applies to <i>drainage systems</i> .
(3)	[F81-OH1.1]
	[F81-OH2.1,OH2.3]
(4)	[F81-OH1.1] Applies to <i>venting systems</i> .
	[F81-OH2.1,OH2.3] Applies to <i>drainage systems</i> .
(5)	[F81-OH2.1,OH2.3]
<b>2.3.6.2. Tests of Pipes in Drainage Systems</b>	
(1)	[F81-OH2.1,OH2.3]
	[F81-OP5]
(2)	[F81-OH2.1]
<b>2.3.6.3. Tests of Venting Systems</b>	
(1)	[F81-OH1.1]
<b>2.3.6.4. Water Pressure Tests</b>	
(1)	[F81-OH1.1]
	[F81-OH2.1,OH2.3]

Table 2.8.1.1. (Continued)

Provision	Functional Statements and Objectives <sup>(1)</sup>
(2)	[F81-OH1.1]
	[F81-OH2.1,OH2.3]
<b>2.3.6.5. Air Pressure Tests</b>	
(1)	[F81-OH1.1]
	[F81-OH2.1,OH2.3]
<b>2.3.6.6. Final Tests</b>	
(1)	[F81-OH1.1]
	[F81-OH2.1,OH2.3]
(2)	[F81-OH1.1]
	[F81-OH2.1,OH2.3]
<b>2.3.6.7. Ball Tests</b>	
(1)	[F81-OH2.1,OH2.3]
(2)	[F81-OH2.1,OH2.3]
<b>2.3.7.1. Application of Tests</b>	
(1)	[F81-OP5]
(3)	[F81-OP5]
(4)	[F81-OP5]
<b>2.3.7.2. Pressure Tests of Potable Water Systems</b>	
(1)	[F20-OP5]
(2)	[F20,F81-OS3.1]
<b>2.3.7.3. Water Pressure Tests</b>	
(1)	[F81-OP5]
(2)	[F70-OH2.2]
<b>2.4.2.1. Connections to Sanitary Drainage Systems</b>	
(1)	[F72-OH2.1] Applies to <i>fixtures that are directly connected to sanitary drainage systems</i> .
	(a) [F81-OH2.2]
	(b) [F81-OH2.2]
	(c) [F81-OH2.1]
	(d) [F81-OH2.1]
	(e) [F81-OH2.1]
(2)	[F81-OH1.1]
(3)	[F81-OH1.1]
(4)	[F81-OH1.1]
(5)	[F81-OH1.1]
<b>2.4.2.2. Connection of Overflows from Rainwater Tanks</b>	
(1)	[F81-OH2.2]
<b>2.4.2.3. Direct Connections</b>	
(1)	[F81-OH2.2]
(2)	[F81-OH2.1,OH2.4]
(3)	[F81-OH2.4]
<b>2.4.3.1. Urinals</b>	
(1)	[F81-OH2.4]



Table 2.8.1.1. (Continued)

Provision	Functional Statements and Objectives <sup>(1)</sup>
<b>2.4.3.2. Restricted Locations of Indirect Connections and Traps</b>	
(1)	[F81-OH2.1,OH2.4]
<b>2.4.3.3. Equipment Restrictions Upstream of Grease Interceptors</b>	
(1)	[F81-OH2.1]
<b>2.4.3.4. Fixtures Located in Chemical Storage Locations</b>	
(1)	[F81-OS1.1]
	[F43-OH5]
<b>2.4.3.5. Macerating Toilet Systems</b>	
(1)	[F72-OH2.1]
<b>2.4.3.6. Drains Serving Elevator Pits</b>	
(1)	(a) [F62-OP5]
	(b) [F81-OH2.1]
<b>2.4.4.1. Sewage Treatment</b>	
(1)	[F81-OH2.1]
<b>2.4.4.2. Cooling of Hot Water or Sewage</b>	
(1)	[F81-OH2.1]
<b>2.4.4.3. Interceptors</b>	
(1)	[F81-OH2.1]
(2)	[F81-OS1.1]
	[F43-OH5]
(3)	[F81-OH2.1]
(4)	[F81-OH2.1]
<b>2.4.4.4. Neutralizing and Dilution Tanks</b>	
(1)	[F80-OS3.4]
(2)	[F43-OH5]
	[F80-OH2.1]
<b>2.4.5.1. Traps for Sanitary Drainage Systems</b>	
(1)	[F81-OH1.1]
(6)	[F81-OH1.1]
	[F81-OP5]
<b>2.4.5.2. Traps for Storm Drainage Systems</b>	
(1)	[F81-OH1.1]
(2)	[F81-OH1.1]
(3)	[F81-OP5]
<b>2.4.5.3. Connection of Subsoil Drainage Pipe to a Sanitary Drainage System</b>	
(1)	[F81-OH2.1]
	[F81-OH1.1]
<b>2.4.5.4. Location and Cleanout for Building Traps</b>	
(1)	[F81-OH2.1]
<b>2.4.5.5. Trap Seals</b>	
(1)	[F81-OH1.1]

Table 2.8.1.1. (Continued)

Provision	Functional Statements and Objectives <sup>(1)</sup>
<b>2.4.6.1. Separate Systems</b>	
(1)	[F81-OH2.1]
(2)	[F81-OH2.1]
(3)	[F81-OH1.1]
<b>2.4.6.2. Location of Sanitary Drainage Pipes</b>	
(1)	[F81-OH2.2]
<b>2.4.6.3. Sumps or Tanks</b>	
(1)	[F81-OH2.1]
(2)	[F81-OH2.1] Applies to the watertightness of sumps or tanks.
	[F40,F81-OH1.1]
(3)	[F40,F81-OH2.1]
	[F40,F81-OH1.1]
(4)	[F81-OH2.1]
(5)	[F81-OH2.1]
(6)	[F81-OH2.1]
(7)	[F81-OH2.1]
(8)	[F81-OH2.1]
<b>2.4.6.4. Protection from Backflow</b>	
(1)	[F81-OH2.1]
(2)	[F81-OH2.1]
(3)	[F81-OH2.1]
(5)	[F81-OH1.1]
	[F81-OH2.1]
(6)	[F81-OH2.1]
	[F81-OH1.1]
<b>2.4.6.5. Mobile Home Sewer Service</b>	
(1)	[F81-OH2.1]
<b>2.4.7.1. Cleanouts for Drainage Systems</b>	
(1)	[F81-OH2.1]
(2)	[F81-OH2.1]
(3)	[F81-OH2.1]
(4)	[F81-OH2.1]
(5)	[F81-OH2.1]
(6)	[F81-OH2.1]
(7)	[F81-OH2.1]
(8)	[F81-OH2.1]
(9)	[F81-OH2.1]
(10)	[F82-OH2.1]
	[F82-OP5]
(11)	[F81-OH2.1]
	[F81-OP5]

**Table 2.8.1.1. (Continued)**

Provision	Functional Statements and Objectives <sup>(1)</sup>
<b>2.4.7.2. Size and Spacing of Cleanouts</b>	
(1)	[F81-OH2.1]
(2)	[F81-OH2.1]
(3)	[F81-OH2.1]
(4)	[F81-OH2.1]
(5)	[F81-OH2.1]
<b>2.4.7.3. Manholes</b>	
(1)	[F20-OS3.1]
(2)	(a),(c) [F81-OH1.1]
	(a),(c) [F81-OS1.1]
	(b) [F20-OS3.1]
(3)	[F30-OS3.1]
(4)	[F81-OH2.1]
<b>2.4.7.4. Location of Cleanouts</b>	
(1)	[F81-OH2.1]
(2)	(a) [F81-OS3.1]
	(b) [F81-OH2.1]
(3)	[F81-OH2.1]
(4)	[F81-OH2.1] Applies to drainage piping.
	[F81-OH1.1] Applies to vent piping.
(5)	[F43-OH5]
	[F43-OS3.4]
<b>2.4.8.1. Minimum Slope</b>	
(1)	[F81-OH2.1]
<b>2.4.8.2. Length of Fixture Outlet Pipes</b>	
(1)	[F81-OH1.1]
<b>2.4.9.1. No Reduction in Size</b>	
(1)	[F81-OH2.1]
	[F81-OH1.1]
<b>2.4.9.2. Serving Water Closets</b>	
(1)	[F81-OH2.1]
(2)	[F81-OH2.1]
(3)	[F81-OH2.1]
(4)	[F81-OH2.1]
<b>2.4.9.3. Size of Fixture Outlet Pipes</b>	
(1)	[F81-OH2.1]
(2)	[F81-OH2.1]
(3)	[F81-OP5]
	[F81-OH1.1]
<b>2.4.9.4. Size of Building Drain and Building Sewer</b>	
(1)	[F81-OH2.1]
<b>2.4.9.5. Offset in Leaders</b>	
(1)	[F81-OH2.1,OH2.3]

**Table 2.8.1.1. (Continued)**

Provision	Functional Statements and Objectives <sup>(1)</sup>
(2)	[F81-OH2.1]
<b>2.4.10.1. Total Load on a Pipe</b>	
(1)	[F81-OH2.1]
<b>2.4.10.2. Hydraulic Loads for Fixtures</b>	
(2)	[F81-OH2.1]
<b>2.4.10.3. Hydraulic Loads from Fixtures with a Continuous Flow</b>	
(1)	[F81-OH2.1]
(2)	[F81-OH2.1]
<b>2.4.10.4. Hydraulic Loads from Roofs or Paved Surfaces</b>	
(1)	[F81-OP5]
	[F20,F81-OS2.1]
(2)	[F20,F81-OP5]
	(a),(d),(e) [F41,F81-OH2.4]
	(b),(c) [F20,F81-OS2.1]
(3)	[F20,F81-OP5]
	[F20,F81-OS2.1]
(4)	[F21,F81-OP5]
	[F20,F81-OS2.1]
<b>2.4.10.5. Conversion of Fixture Units to Litres</b>	
(1)	[F81-OH2.1]
<b>2.4.10.6. Hydraulic Loads to Sanitary Drainage Pipes</b>	
(1)	[F72-OH2.1,OH2.3]
(2)	[F72-OH2.1,OH2.3]
<b>2.4.10.7. Hydraulic Loads on Branches</b>	
(1)	[F72-OH2.1,OH2.3]
<b>2.4.10.8. Hydraulic Loads on Sanitary Building Drains or Sewers</b>	
(1)	[F81-OH2.1,OH2.3]
<b>2.4.10.9. Hydraulic Loads on Storm or Combined Building Drains or Sewers</b>	
(1)	[F81-OH2.1,OH2.3]
<b>2.4.10.10. Hydraulic Loads to Roof Gutters</b>	
(1)	[F81-OP5]
<b>2.4.10.11. Hydraulic Loads on Leaders</b>	
(1)	[F81-OP5]
<b>2.4.10.12. Hydraulic Loads from Fixtures with a Semi-continuous Flow</b>	
(1)	[F81-OP5]
<b>2.4.10.13. Design of Storm Sewers</b>	
(1)	[F81-OH2.1]
<b>2.5.1.1. Venting for Traps</b>	
(1)	[F81-OH1.1]
(2)	[F81-OH1.1]

Table 2.8.1.1. (Continued)

Provision	Functional Statements and Objectives <sup>(1)</sup>
<b>2.5.2.1. Wet Venting</b>	
(1)	[F81-OH1.1]
<b>2.5.3.1. Circuit Venting</b>	
(1)	[F40,F81-OH1.1]
(2)	[F40,F81-OH1.1]
(3)	[F40,F81-OH1.1]
(4)	[F40,F81-OH1.1]
(5)	[F40,F81-OH1.1]
(6)	[F40,F81-OH1.1]
(7)	[F40,F81-OH1.1]
(8)	[F40,F81-OH1.1]
(9)	[F40,F81-OH1.1]
(10)	[F40,F81-OH1.1]
(11)	[F40,F81-OH1.1]
<b>2.5.4.1. Stack Vents</b>	
(1)	[F40,F81-OH1.1]
<b>2.5.4.2. Vent Stacks</b>	
(1)	[F40,F81-OH1.1]
(3)	[F40,F81-OH1.1]
(4)	[F40,F81-OH1.1]
<b>2.5.4.3. Yoke Vents</b>	
(1)	[F40,F81-OH1.1]
(2)	[F40,F81-OH1.1]
(3)	[F40,F81-OH1.1]
(4)	[F40,F81-OH1.1]
<b>2.5.4.4. Offset Relief Vents</b>	
(1)	[F40,F81-OH1.1]
<b>2.5.4.5. Fixtures Draining into Vent Pipes</b>	
(1)	[F40,F81-OH1.1]
<b>2.5.5.1. Venting of Sewage Sumps</b>	
(1)	[F40,F81-OH1.1]
<b>2.5.5.2. Venting of Oil Interceptors</b>	
(1)	[F40,F81-OS1.1]
	[F72,F81-OH2.1,OH2.3]
	[F40,F81-OH1.1]
(2)	[F40,F81-OS1.1]
	[F40,F81-OH1.1]
(3)	[F40,F81-OS1.1]
(4)	[F40,F81-OS1.1]
(5)	[F40,F81-OS1.1]
<b>2.5.5.3. Venting of Drain Piping and Tanks for Corrosive Waste</b>	
(1)	[F80,F81-OS3.4]

Table 2.8.1.1. (Continued)

Provision	Functional Statements and Objectives <sup>(1)</sup>
<b>2.5.5.4. Fresh Air Inlets</b>	
(1)	[F81-OH1.1]
<b>2.5.5.5. Provision for Future Installations</b>	
(1)	[F81-OH1.1] Applies to <i>venting systems</i> .
	[F81-OH2.1,OH2.3] Applies to <i>drainage systems</i> .
(2)	[F40,F81-OH1.1]
<b>2.5.6.1. Drainage of Vent Pipes</b>	
(1)	[F81-OH1.1]
	[F81-OS1.1]
<b>2.5.6.2. Vent Pipe Connections</b>	
(1)	[F81-OH1.1]
(2)	[F81-OH1.1]
(3)	[F40,F81-OH1.1]
<b>2.5.6.3. Location of Vent Pipes</b>	
(1)	[F81-OH1.1]
(2)	[F81-OH2.1,OH2.3]
(3)	[F81-OH1.1]
(4)	[F40,F81-OH1.1]
<b>2.5.6.4. Connection of Vents above Fixtures Served</b>	
(1)	[F81-OH1.1]
(2)	[F81-OH1.1]
<b>2.5.6.5. Terminals</b>	
(1)	[F81-OH1.1]
(2)	[F81-OH1.1]
(3)	[F81-OH1.1]
(4)	[F81-OH1.1]
(5)	[F81-OH1.1]
(6)	[F81-OH1.1]
<b>2.5.7.1. General</b>	
(1)	[F81-OH1.1]
<b>2.5.7.2. Size Restriction</b>	
(1)	[F81-OH1.1]
(2)	[F81-OH1.1]
<b>2.5.7.3. Additional Circuit Vents and Relief Vents</b>	
(1)	[F81-OH1.1]
(2)	[F81-OH1.1]
<b>2.5.7.4. Offset Relief Vents</b>	
(1)	[F81-OH1.1]
<b>2.5.7.5. Yoke Vents</b>	
(1)	[F81-OH1.1]
<b>2.5.7.6. Vent Pipes for Manholes</b>	
(1)	[F81-OH2.1]

**Table 2.8.1.1. (Continued)**

Provision	Functional Statements and Objectives <sup>(1)</sup>
<b>2.5.7.7. Vents for Sewage Sumps, Neutralizing and Dilution Tanks, and Macerating Toilet Systems</b>	
(1)	[F81-OH2.1]
(2)	[F81-OH2.1]
(3)	[F81-OH1.1]
<b>2.5.8.1. Hydraulic Loads Draining to Wet Vents</b>	
(1)	[F81-OH1.1]
<b>2.5.8.2. Individual Vents and Dual Vents</b>	
(1)	[F81-OH1.1]
<b>2.5.8.3. Branch Vents, Vent Headers, Continuous Vents and Circuit Vents</b>	
(1)	[F81-OH1.1]
<b>2.5.8.4. Vent Stacks or Stack Vents</b>	
(3)	[F81-OH1.1]
(4)	[F81-OH1.1]
<b>2.5.9.2. Air Admittance Valves</b>	
(1)	[F40,F81-OH1.1]
(2)	[F40,F81-OH1.1]
<b>2.5.9.3. Installation Conditions</b>	
(1)	[F40,F81-OH1.1]
(2)	[F40,F81-OH1.1]
(3)	[F40,F81-OH1.1]
(4)	[F40,F81-OH1.1]
(5)	[F40,F81-OH1.1]
<b>2.6.1.1. Design</b>	
(1)	[F31-OS3.2]
(2)	[F71-OH2.3]
<b>2.6.1.2. Drainage</b>	
(1)	[F81-OP5]
<b>2.6.1.3. Shut-off Valves</b>	
(1)	[F81-OP5]
(2)	[F81-OP5]
(3)	[F81-OP5]
(4)	[F81-OP5]
(5)	[F70,F72-OH2.1,OH2.3]
(6)	[F70,F72-OH2.1,OH2.3]
(7)	[F70,F81-OH2.1,OH2.3]
<b>2.6.1.4. Protection for Exterior Water Supply</b>	
(1)	[F81-OP5]
<b>2.6.1.5. Check Valves</b>	
(1)	[F20,F81-OP5]
<b>2.6.1.6. Flushing Devices</b>	
(1)	[F72-OH2.1]

**Table 2.8.1.1. (Continued)**

Provision	Functional Statements and Objectives <sup>(1)</sup>
(2)	[F72-OH2.1]
(3)	[F130-OE1.2]
(4)	[F81-OH2.1]
(5)	[F130-OE1.2]
<b>2.6.1.7. Relief Valves</b>	
(1)	[F31,F81-OS3.2]
(2)	[F81-OS3.1,OS3.2]
(4)	(a) [F31-OS3.2] [F81-OS1.1] (b) [F81-OS3.1,OS3.2]
(5)	[F31-OS3.2] (b) [F81-OH2.2] Applies to the size of <i>air breaks</i> .
(6)	[F31-OS3.2]
(7)	[F31-OS3.2]
(8)	[F81-OS3.2]
(9)	[F81-OP5]
(10)	[F81-OP5]
<b>2.6.1.8. Solar Domestic Hot Water Systems</b>	
(1)	[F31-OS3.2] [F81-OS3.4] [F70-OH2.2]
<b>2.6.1.9. Water Hammer</b>	
(1)	[F20,F81-OS3.2] [F20,F81-OP5]
<b>2.6.1.10. Mobile Home Water Service</b>	
(1)	[F71,F70,F46-OH2.2,OH2.3]
<b>2.6.1.11. Thermal Expansion</b>	
(1)	[F20,F81,F46-OP5]
<b>2.6.1.12. Service Water Heaters</b>	
(1)	[F40-OS3.4]
<b>2.6.2.1. Connection of Systems</b>	
(1)	[F70,F81,F46-OH2.1,OH2.2,OH2.3]
(2)	[F70,F81,F46-OH2.1,OH2.2,OH2.3]
(3)	[F70,F81,F82-OH2.2,OH2.3]
<b>2.6.2.2. Back-Siphonage</b>	
(1)	[F70,F81,F46-OH2.1,OH2.2,OH2.3]
(2)	[F70,F81,F46-OH2.1,OH2.2,OH2.3]
<b>2.6.2.3. Backflow Caused by Back Pressure</b>	
(1)	[F70,F81,F46-OH2.1,OH2.2,OH2.3]
(2)	[F70,F81,F46-OH2.1,OH2.2,OH2.3]
(3)	[F70,F81,F46-OH2.1,OH2.2,OH2.3]
<b>2.6.2.4. Backflow from Fire Protection Systems</b>	
(2)	[F46,F70,F81-OH2.1,OH2.2,OH2.3]
(3)	[F46,F70,F81-OH2.1,OH2.2,OH2.3]
(4)	[F46,F70,F81-OH2.1,OH2.2,OH2.3]

Table 2.8.1.1. (Continued)

Provision	Functional Statements and Objectives <sup>(1)</sup>
<b>2.6.2.5. Separation of Water Supply Systems</b>	
(1)	[F46,F70,F81-OH2.2]
<b>2.6.2.6. Premise Isolation</b>	
(1)	[F70,F81,F82-OH2.1,OH2.2,OH2.3]
<b>2.6.2.7. Hose Bibb</b>	
(1)	[F70,F81,F46-OH2.1,OH2.2,OH2.3]
<b>2.6.2.8. Cleaning of Systems</b>	
(1)	[F70,F81,F46-OH2.1,OH2.2,OH2.3]
<b>2.6.2.9. Air Gap</b>	
(1)	[F70,F81,F46-OH2.1,OH2.2,OH2.3]
(2)	[F70,F81,F46-OH2.1,OH2.2,OH2.3]
<b>2.6.2.10. Vacuum Breakers</b>	
(2)	[F70,F81,F46-OH2.1,OH2.2,OH2.3]
(3)	[F70,F81,F46-OH2.1,OH2.2,OH2.3]
(4)	[F70,F81,F46-OH2.1,OH2.2,OH2.3]
<b>2.6.2.11. Tank-Type Water Closets</b>	
(1)	[F70,F81,F46-OH2.1,OH2.2,OH2.3]
<b>2.6.2.12. Backflow Preventers</b>	
(1)	[F70,F81,F46-OH2.1,OH2.2,OH2.3]
<b>2.6.3.1. Design, Fabrication and Installation</b>	
(1)	[F71,F72-OH2.1,OH2.3]
(2)	[F72-OH2.1] [F70-OH2.2] [F71-OH2.3]
(3)	[F81-OS1.4]
	[F70,F71-OH2.1,OH2.3]
	[F81-OP5]
<b>2.6.3.2. Hydraulic Load</b>	
(1)	[F71,F72-OH2.1,OH2.3]
(2)	[F71,F72-OH2.1,OH2.3]
(3)	[F71,F72-OH2.1,OH2.3]
(4)	[F81-OH2.1,OH2.2]
<b>2.6.3.3. Static Pressure</b>	
(1)	[F80,F81-OS3.4]
	[F81-OP5]
<b>2.6.3.4. Size</b>	
(1)	[F71,F72-OH2.1,OH2.3]
(2)	[F71,F72-OH2.1,OH2.3]
(3)	[F71,F72-OH2.1,OH2.3]
(4)	[F81-OH2.3]
(5)	[F71,F72-OH2.1,OH2.3]
<b>2.6.3.5. Velocity</b>	
(1)	[F81-OH2.1,OH2.3]
	[F81-OP5]
	[F81-OS3.1]

Table 2.8.1.1. (Continued)

Provision	Functional Statements and Objectives <sup>(1)</sup>
<b>2.7.1.1. General</b>	
(1)	[F81-OH2.2]
(2)	[F82-OH2.2]
(3)	[F40-OH2.2]
(4)	[F46-OH2.2]
(5)	[F80,F81-OS3.4]
	[F81-OP5]
<b>2.7.1.2. Identification and Marking</b>	
(1)	[F46-OH2.2]
	[F81-OH2.2]
<b>2.7.1.3. Location of Pipes</b>	
(1)	[F46,F40-OH2.2]
	[F40,F81-OH2.4]
<b>2.7.1.4. Location of Outlets</b>	
(1)	[F40,F46-OH2.2]
<b>2.7.2.2. Permitted Applications</b>	
(1)	[F46-OH2.2]
	[F81-OH2.2]
<b>2.7.2.3. Roof Design</b>	
(1)	[F41-OH2.2]
(2)	[F41-OH2.2]
<b>2.7.2.4. Non-Potable Rainwater Harvesting System Design</b>	
(1)	[F46,F80,F81-OH2.2]
(2)	[F41-OH2.2]
(3)	[F40-OH2.2]
(4)	[F41-OH2.2]
(5)	[F80,F81-OS3.4]
	[F81-OP5]
(6)	[F81-OH2.2]
(7)	[F81-OH2.2]
	[F81-OP5]
(8)	[F81-OH2.2]
	[F81-OP5]
(9)	[F46-OH2.2]
(10)	[F46-OH2.2]

**Notes to Table 2.8.1.1.:**

(1) See Parts 2 and 3 of Division A.

# Notes to Part 2 Plumbing Systems

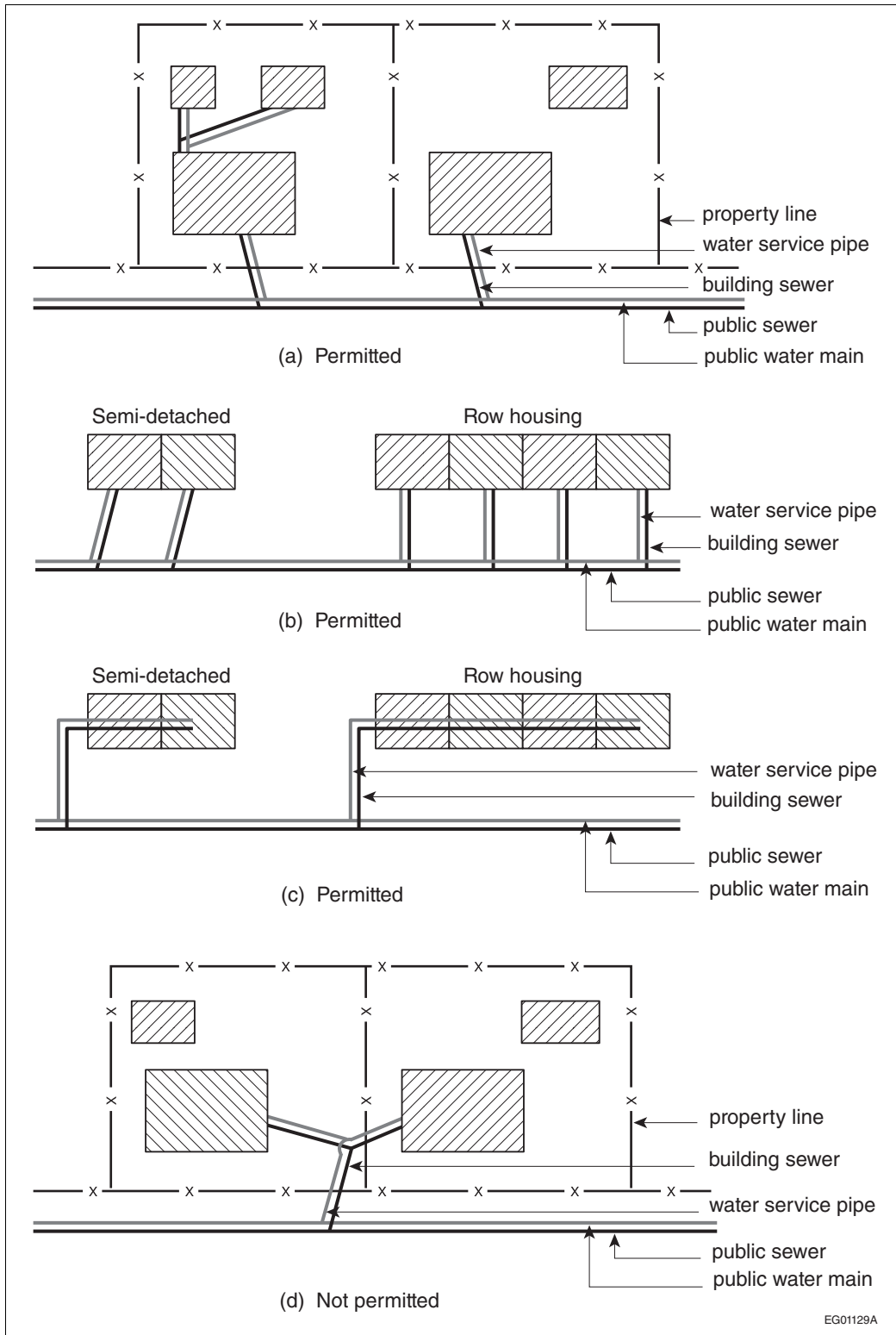
**A-2.1.2.1.(2) Combined Building Drains.** Combined building drains may have proven acceptable on the basis of past performance in some localities and their acceptance under this Code may be warranted.

**A-2.1.2.4.(1) Service Piping.** The layout as shown in Figure A-2.1.2.4.(1)(c) may require special legal arrangements in some jurisdictions to ensure that access can be provided to all parts of the service pipes.

---

These Notes are included for explanatory purposes only and do not form part of the requirements. The number that introduces each Note corresponds to the applicable requirement in this Part.

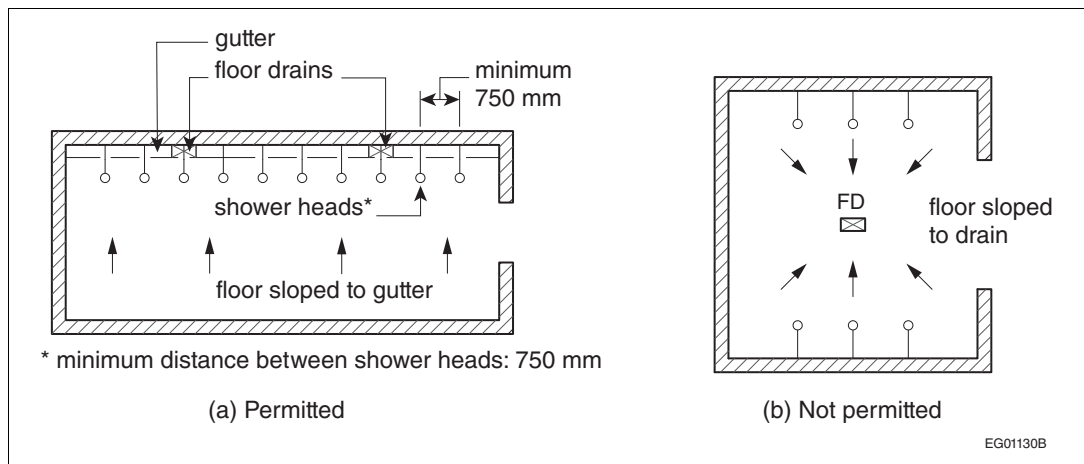
The figures are schematic only; they depict various parts of the plumbing system but do not include details. For an explanation of the symbols and abbreviations used in the figures, refer to the list provided at the end of the Code.



**Figure A-2.1.2.4.(1)**  
**Service piping**

**A-2.1.4.1.(1) Seismic Restraints and Design.** Sentence 2.1.4.1.(1) aims to help ensure that plumbing systems will remain in place for a sufficient amount of time during an earthquake to allow for the safe evacuation of the building.

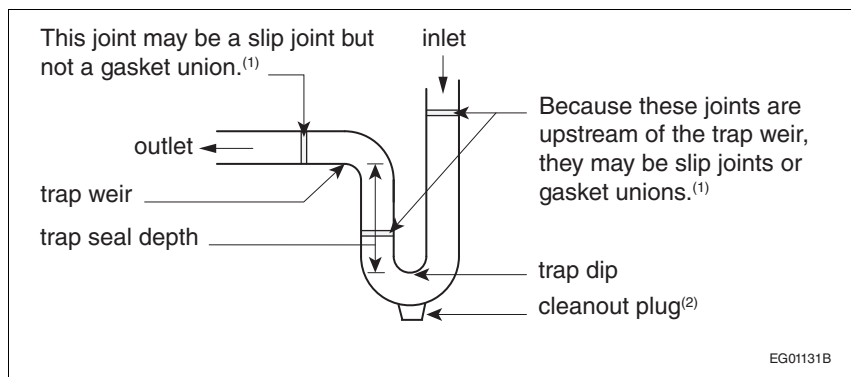
**A-2.2.2.3.(3) Shower Drainage (Plan View).**



**Figure A-2.2.2.3.(3)**  
Shower drainage (plan view)

**A-2.2.2.4.(1) Concealed Overflows.** The use of concealed overflows does not preclude the use of a standing waste.

**A-2.2.3.1.(1) and (3) Trap Seal Depth and Trap Connections.**



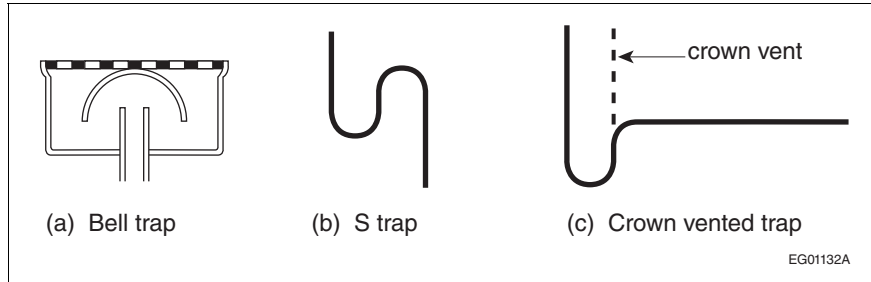
**Figure A-2.2.3.1.(1) and (3)**  
Trap seal depth and trap connections

**Notes to Figure A-2.2.3.1.(1) and (3):**

- (1) See Article 2.3.3.4.
- (2) See Clause 2.2.3.1.(3)(a).



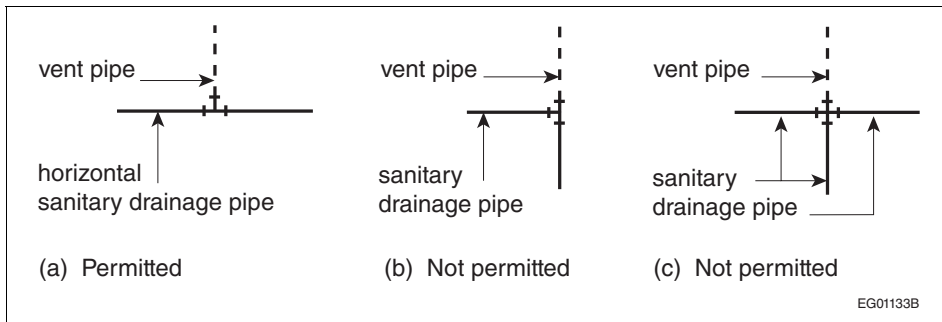
**A-2.2.3.1.(4) Prohibited Traps.** Except for an S-trap standard, the S trap shown in Figure A-2.2.3.1.(4)(b) is prohibited by Clause 2.5.6.3.(1)(b), which limits the fall on fixture drains. Crown vented traps shown in Figure A-2.2.3.1.(4)(c) are prohibited by Clause 2.5.6.3.(1)(a), which requires that the distance from the trap weir to the vent be not less than twice the size of the fixture drain.



**Figure A-2.2.3.1.(4)**  
**Prohibited traps**

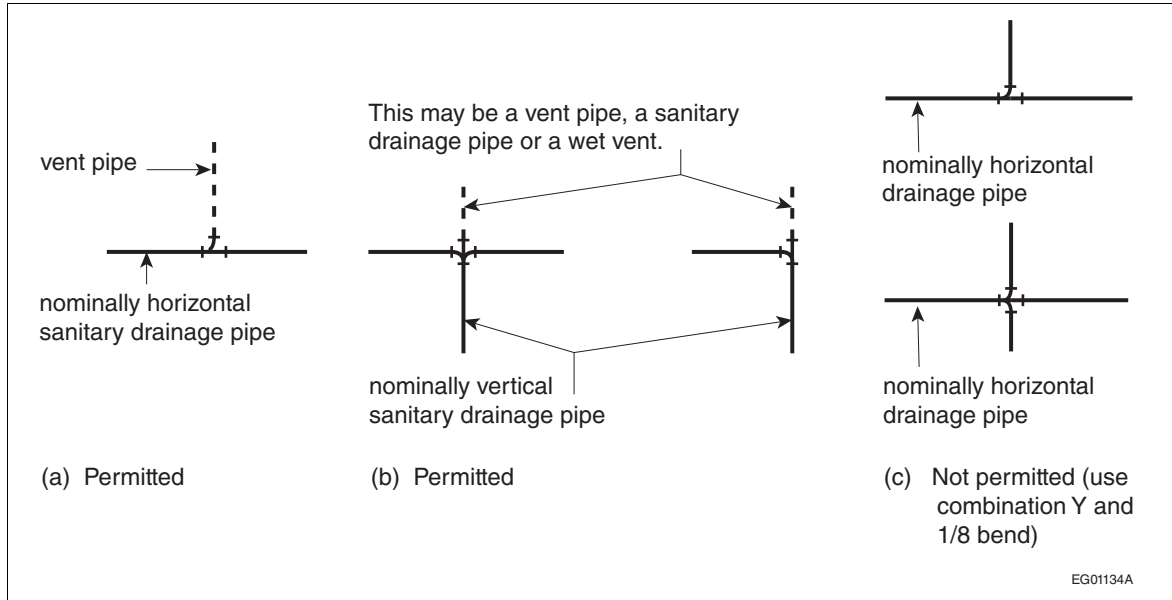
**A-2.2.3.2.(3) Grease Interceptors.** CSA B481.4, “Maintenance of grease interceptors,” is considered to represent good practice regarding procedures for the maintenance of grease interceptors.

**A-2.2.4.1. T Fittings in Drainage Systems.** The use of a cross fitting in a drainage system is prohibited, but such fitting may be used in a venting system to connect 4 vent pipes. In a drainage system, a T fitting can only be used as shown in Figure A-2.2.4.1.(a), and cannot be used as shown in Figure A-2.2.4.1.(b) because the T or cross fitting would change the direction of flow in the drainage system.



**Figure A-2.2.4.1.**  
**T fittings in drainage systems**

**A-2.2.4.2. Sanitary T Fittings in Drainage Systems.** A sanitary T fitting may be used to change the direction of flow in a drainage system from horizontal to vertical, but may not be used to change the direction of flow in a nominally horizontal drainage system. A combination Y and 1/8th bend fitting may also be used as shown in Figure A-2.2.4.2.(b).



**Figure A-2.2.4.2.**  
Sanitary T fittings in drainage systems

**A-2.2.5. to 2.2.8. Pipe and Fitting Applications.**

**A-2.2.5. to 2.2.8.**

**Division B**

**Table A-2.2.5. to 2.2.8.  
Summary of Pipe and Fitting Applications**

NPC References	Types of Piping and Fittings	Standard References	Use of Piping and Fittings <sup>(1)(2)</sup>											
			Drainage System			Venting System		Potable Water System						
			Above-ground inside building	Under-ground under building	Building sewer	Above-ground	Under-ground	Above-ground	Cold	Hot	Under building	Underground		
2.2.5.1.(1)	Fibrocement DWV pipe Type 1, Class 3000 Type 2, Class 4000	CAN/CSA-B127.3	P	P	P	P	P	N	N	N	N	N	N	N
2.2.5.2.	Concrete sewer pipe Sewer, storm drain and culvert Reinforced culvert, storm drain and sewer	CSA A257.1 CSA A257.2	N	P <sup>(3)</sup>	P	N	N	N	N	N	N	N	N	N
2.2.5.3.	Vitrified clay pipe	CSA A60.1-M	N	P	P	N	N	N	N	N	N	N	N	N
2.2.5.4.	PE water pipe and tubing Series 160 sizes with compression fittings Series 50, 75, 100 and 125	CSA B137.1	N	N	N	N	N	N	N	N	N	N	P <sup>(4)</sup>	P <sup>(4)</sup>
2.2.5.5.(1)	PE plastic pipe (DR-PR) based on outside diameter	ASTM F714	N	P	P	N	N	N	N	N	N	N	N	N
2.2.5.6.	PEX pressure tubing	CSA B137.5	N	N	N	N	N	N	N	N	P <sup>(5)(6)</sup>	P <sup>(5)(6)</sup>	P	P
2.2.5.7.(1)	PVC water pipe Dimension ratios (DR) or standard dimension ratios (SDR) 14, 17, 18, 21, 25 and 26 Schedule 40 in sizes from NPS ½ to NPS 2½ inclusively Schedule 80 in sizes from NPS ½ to NPS 6 inclusively	CSA B137.3	N	N	N	N	N	N	N	N	P <sup>(6)(6)</sup>	N	P <sup>(7)</sup>	P <sup>(7)</sup>
2.2.5.7.(2)	PVC fittings Schedule 40 Schedule 80	ASTM D2466 ASTM D2467	N	N	N	N	N	N	N	N	P <sup>(5)(6)</sup>	N	N	N
2.2.5.7.(3)	PVC pressure fittings	CSA B137.2	N	N	N	N	N	N	N	N	P <sup>(5)(6)</sup>	N	P	P
2.2.5.8.	CPVC water pipe	CSA B137.6	N	N	N	N	N	N	N	N	P <sup>(5)(6)(8)</sup>	P <sup>(5)(6)(8)</sup>	P <sup>(8)</sup>	P <sup>(8)</sup>

**Table A-2.2.5. to 2.2.8. (Continued)**

NPC References	Types of Piping and Fittings	Standard References	Use of Piping and Fittings <sup>(1)(2)</sup>											
			Drainage System			Venting System			Potable Water System					
			Above-ground inside building	Under-ground under building	Building sewer	Above-ground	Under-ground	Above-ground	Hot	Under building	Underground	Outside building		
2.2.5.9.	ABS Schedule 40 DWV pipe with a cellular core Plastic sewer pipe PS ≥ 320 kPa PVC sewer pipe (PSM type) ≤ 35-SDR Profile PVC sewer pipe PS ≥ 320 kPa Profile PE sewer pipe PS ≥ 320 kPa	ASTM F628  CAN/CSA-B182.1 CAN/CSA-B182.2  CAN/CSA-B182.4 CAN/CSA-B182.6	P <sup>(5)(6)</sup>	P	P	P <sup>(5)(6)</sup>	P	P	N	N	N	N	N	N
2.2.5.9. and 2.2.5.10.	ABS DWV pipe	CSA B181.1	P <sup>(5)(6)</sup>	P	P	P <sup>(5)(6)</sup>	P	P	N	N	N	N	N	N
2.2.5.12.	PVC DWV pipe	CSA B181.2	P <sup>(5)(6)</sup>	P	P	P <sup>(5)(6)</sup>	P	P	N	N	N	N	N	N
2.2.5.13.	PE/AL/PE pressure pipe	CSA B137.9	N	N	N	N	N	N	P <sup>(5)(6)</sup>	N	N	N	P	P
2.2.5.14.	PEX/AL/PEX pressure pipe	CSA B137.10	N	N	N	N	N	N	P <sup>(5)(6)</sup>	N	N	N	P	P
2.2.5.14.	PP-R pressure pipe	CSA B137.11	N	N	N	N	N	N	P <sup>(5)(6)</sup>	N	N	N	P	P
2.2.5.15.	PE-RT tube	CSA B137.18	N	N	N	N	N	N	P <sup>(5)(6)</sup>	N	N	N	P	P
2.2.5.16.	Cellular core PVC pipe	ASTM F3128	P <sup>(5)(6)(9)</sup>	P <sup>(9)</sup>	N	P <sup>(5)(6)(9)</sup>	P <sup>(9)</sup>	N	N	N	N	N	N	N
2.2.6.1.	Cast-iron soil pipe	CSA B70	P	P	P	P	P	P	N	N	N	N	N	N
2.2.6.4.	Ductile-iron water pipe	ANSI/AWWA C151/A21.51	P	P	P	P	P	P	P	P	P	P	P	P
2.2.6.5.	Screwed cast-iron fittings	ASME B16.4	N	N	N	N	N	N	N	N	N	N	N	N
2.2.6.6.	Screwed malleable-iron fittings	ASME B16.3	N	N	N	N	N	N	N	N	N	N	N	N
2.2.6.7.	Welded and seamless steel galvanized pipe	ASTM A53/A53M	P	N	N	P	N	N	P <sup>(10)</sup>	N	N	P <sup>(10)</sup>	P <sup>(10)</sup>	P <sup>(10)</sup>
2.2.6.8.	Corrugated steel galvanized pipe	CAN/CSA-G401	N	N	P <sup>(11)</sup>	N	N	N	N	N	N	N	N	N
2.2.6.9.	Sheet metal pipe <sup>(12)</sup>	—	N	N	N	N	N	N	N	N	N	N	N	N
2.2.6.10.	Stainless steel pipe	ASTM A312/A312M	P	P	P	P	P	P	P	P	P	P	P	P
2.2.6.14.	Stainless steel tube	ASTM A269/A269M	N	N	N	N	N	N	N	N	N	N	N	N
2.2.7.1.	Copper and brass pipe Copper Red brass	ASTM B42 ASTM B43	P	P	P	P	P	P	P	P	P	P	P	P

**Table A-2.2.5. to 2.2.8. (Continued)**

NPC References	Types of Piping and Fittings	Standard References	Use of Piping and Fittings <sup>(1)(2)</sup>											
			Drainage System			Venting System			Potable Water System					
			Above-ground inside building	Under-ground under building	Building sewer	Above-ground	Under-ground	Cold	Hot	Under building	Underground	Outside building		
2.2.7.3.	Brass or bronze threaded water fittings	ASME B16.15	N	N	N	N	N	N	P	P	P	P	P	P
2.2.7.4.	Copper tube Types K and L hard temper Types K and L soft temper Type M hard temper Type M soft temper Type DWV	ASTM B88  ASTM B306	P	P	P	P	P	P	P	P	P	P	N	N
2.2.7.5.	Solder-joint drainage fittings	ASME B16.23 and ASME B16.29	P	P	P	P	P	P	P	P	N	N	N	N
2.2.7.6.	Solder-joint water fittings	ASME B16.18 and ASME B16.22	N	N	N	N	N	N	P	P	P	P	P	P
2.2.7.8.	Lead sanitary drainage pipe	—	P	P	N	N	P	P	P	P	N	N	N	N
2.2.8.1.	Polyolefin laboratory drainage systems	CSA B181.3	P <sup>(6)</sup>	P	P	P	P <sup>(5)(6)</sup>	P	P	N	N	N	N	N

**Notes to Table A-2.2.5. to 2.2.8.:**

- (1) N = not permitted and P = permitted.
- (2) Where firestops are pierced by pipes, the integrity of the firestop must be maintained.
- (3) Gasketed joints required.
- (4) Permitted only for water service pipe.
- (5) Combustible piping in noncombustible construction is subject to the requirements of Sentence 3.1.5.19.(1) of Division B of the NBC.
- (6) Combustible piping that penetrates a fire separation is subject to the requirements in Articles 3.1.9.4. and 9.10.9.7. to 9.10.9.9. of Division B of the NBC.
- (7) Not permitted in hot water systems.
- (8) Not to exceed design temperature and design pressure stated in Sentence 2.2.5.8.(2).
- (9) Permitted only in residential buildings containing 1 or 2 dwelling units and row houses that do not exceed 3 storeys in height.
- (10) Permitted only in buildings of industrial occupancy as described in the NBC, or for the repair of existing galvanized steel piping systems.
- (11) Permitted underground only in a storm drainage system.
- (12) Permitted only for an external leader.
- (13) Not permitted for the fixture drain or vent below the flood level rim of a flush-valve-operated urinal.

**A-2.2.5.2.(3) Concrete Fittings.** Concrete fittings fabricated on site from lengths of pipe may have proven acceptable on the basis of past performance in some localities and their acceptance under this Code may be warranted.

**A-2.2.5.5.(1) Polyethylene Pipe Used Underground.** Joints within the high-density polyethylene pipe (HDPE) shall be heat-fused according to the manufacturer's instructions. Joints between HDPE pipes and other materials shall be made with a suitable hubless coupling.

**A-2.2.5.6.(1) Crosslinked Polyethylene Pipe and Fittings.** There are some special installation requirements for the use of crosslinked polyethylene pipe and its associated fittings. Reference should, therefore, be made to the installation information in CSA B137.5, "Crosslinked polyethylene (PEX) tubing systems for pressure applications."

**A-2.2.5.9. to 2.2.5.11. Solvent Cement.** CSA B137.6, "Chlorinated polyvinylchloride (CPVC) pipe, tubing, and fittings for hot- and cold-water distribution systems," CSA B181.1, "Acrylonitrile-butadiene-styrene (ABS) drain, waste, and vent pipe and pipe fittings," and CSA B181.2, "Polyvinylchloride (PVC) and chlorinated polyvinylchloride (CPVC) drain, waste, and vent pipe and pipe fittings," reference ASTM D3138, "Standard Specification for Solvent Cements for Transition Joints Between Acrylonitrile-Butadiene-Styrene (ABS) and Poly(Vinyl Chloride) (PVC) Non-Pressure Piping Components," which specifies the colour of the solvent cement. PVC cement shall be grey, ABS cement shall be yellow, CPVC cement shall be clear and transition cement shall be white. The standard colour allows Code users to readily determine if the correct solvent cement has been used. It should be noted that a transition cement is not an all-purpose cement.

**A-2.2.5.12.(1) Polyethylene/Aluminum/Polyethylene Composite Pipe and Fittings.** There are some special installation requirements for the use of polyethylene/aluminum/polyethylene composite pipe and fittings. Reference should, therefore, be made to the installation information in CSA B137.9, "Polyethylene/aluminum/polyethylene (PE-AL-PE) composite pressure-pipe systems."

**A-2.2.5.13.(1) Crosslinked Polyethylene/Aluminum/Crosslinked Polyethylene Composite Pressure Pipe and Fittings.** There are some special installation requirements for the use of crosslinked polyethylene/aluminum/crosslinked polyethylene composite pipe and fittings. Reference should, therefore, be made to the installation information in CSA B137.10, "Crosslinked polyethylene/aluminum/crosslinked polyethylene (PEX-AL-PEX) composite pressure-pipe systems."

**A-2.2.5.14.(1) Polypropylene Pipe and Fittings.** There are some special installation requirements for the use of polypropylene pipe and fittings. Reference should, therefore, be made to the installation information in CSA B137.11, "Polypropylene (PP-R & PP-RCT) pipe and fittings for pressure applications."

**A-2.2.5.15.(1) Polyethylene of Raised Temperature Tube.** It should be noted that CSA B137.18, "Polyethylene of raised temperature resistance (PE-RT) tubing systems for pressure applications," contains special installation requirements, which should be followed.

**A-2.2.6.7.(3) Galvanized Steel Pipe.** The use of galvanized steel pipe and fittings in a water distribution system may have proven acceptable on the basis of past performance in some localities and its acceptance under this Code may be warranted.

**A-2.2.10.5.(1) Saddle Hubs or Fittings.** Saddle hubs or fittings may have proven acceptable on the basis of past performance in some localities and their acceptance under this Code may be warranted.

**A-2.2.10.6.(2) Supply Fittings and Individual Shower Heads.** Flow restriction devices within supply fittings should not be removed.

Due to the low flow rate of public lavatory faucets, design consideration should be given to the wait time for hot water to be delivered to each fixture.

**A-2.2.10.6.(3) Automatic Compensating Valves.** When replacing a shower head, the appropriate shower valve with a suitable compensating feature matching the flow rate should be chosen to decrease the possibility that users will suffer thermal shock. The water flow rate of automatic compensating mixing valves can be found in ASSE 1016/ASME A112.1016/CSA B125.16, "Performance Requirements for Automatic Compensating Valves for Individual Showers and Tub/Shower Combinations."

**A-2.2.10.6.(4) and (5) Automatic Shut-off of Water Flow.** Examples of water shut-off devices include occupant sensors and self-closing valves.

**A-2.2.10.6.(7) Manually Operated Valves.** Manually operated valves are also known in the industry as supply line stops.

**A-2.2.10.7. Hot Water Temperature.** Hot water delivered at 60°C, a typical thermostat setting for storage-type service water heaters, will severely burn human skin in 1 to 5 s. Consequently, Article 2.2.10.7. sets an upper limit on the temperature of water discharging from shower heads and into bathtubs. The water temperature is maintained at or below this limit through the installation and adjustment of automatic compensating valves or temperature-limiting devices. Compliance with the Article reduces the risk of scalding in showers and bathtubs, which could result in severe burns, and the risk of thermal shock in showers, which could lead to falls. Children, older adults and people with disabilities are particularly at risk of scalding because they are not always able to remove themselves quickly from a shower or bathtub if the water becomes too hot.

At a water temperature of 49°C, the time for a scald burn to occur on an adult is nearly 10 min, whereas the time for a scald burn to occur on an older adult is only 2 min because their skin is thinner and less vascularized. At a water temperature of 43°C, scald burns occur only after several hours of exposure. Therefore, setting 43°C as the maximum temperature for water discharging from shower heads and into bathtubs provides suitable protection from scald burns in healthcare facilities and seniors' residences.

Although the temperature of water discharging into other fixtures, such as lavatories, sinks, laundry trays and bidets, is not addressed by Article 2.2.10.7., a risk of scalding may nonetheless exist at such fixtures.

It should be noted that pressure-balanced valves are sensitive to seasonal changes in the temperature of the cold water supply and may require adjustments throughout the year to avoid exceeding the maximum water temperature prescribed in Article 2.2.10.7.

**A-2.2.10.9.(3) Bubblers.** Bubblers installed on other than drinking fountains may have proven acceptable on the basis of past performance in some localities and their acceptance under this Code may be warranted.

**A-2.2.10.16.(1) Air Admittance Valve.** An air admittance valve is a device that is closed by gravity and seals the vent terminal at zero differential pressure (no flow conditions) and under positive internal pressures. The valve allows air to enter the drainage system without the use of a vent extended to outside air and prevents trap siphonage.

The material of the diaphragm can be damaged by exposure to acidic or corrosive fumes in the ambient atmosphere; therefore, air admittance valves should not be installed in locations where there is a potential for exposure to such fumes.

**A-2.3.2.6.(1) Mechanical Joints.** Storm sewer blockage can cause mechanical joints at the base of leaders to fail, which results in flooding. The failure occurs because the cleanout joints at the base of the rainwater leaders are not able to withstand the water column pressure. To avoid such failures, it is necessary to ensure that storm water systems installed using mechanical joints be braced and/or restrained at the ends of branches, changes in direction and elevation, at dead ends and at other locations as required by the manufacturer to prevent the separation of joints due to internal pressure, mechanical stress or seismic events. Care should be taken to replace cleanouts properly after maintenance or testing.

A-2.3.3.9. Linear Expansion.

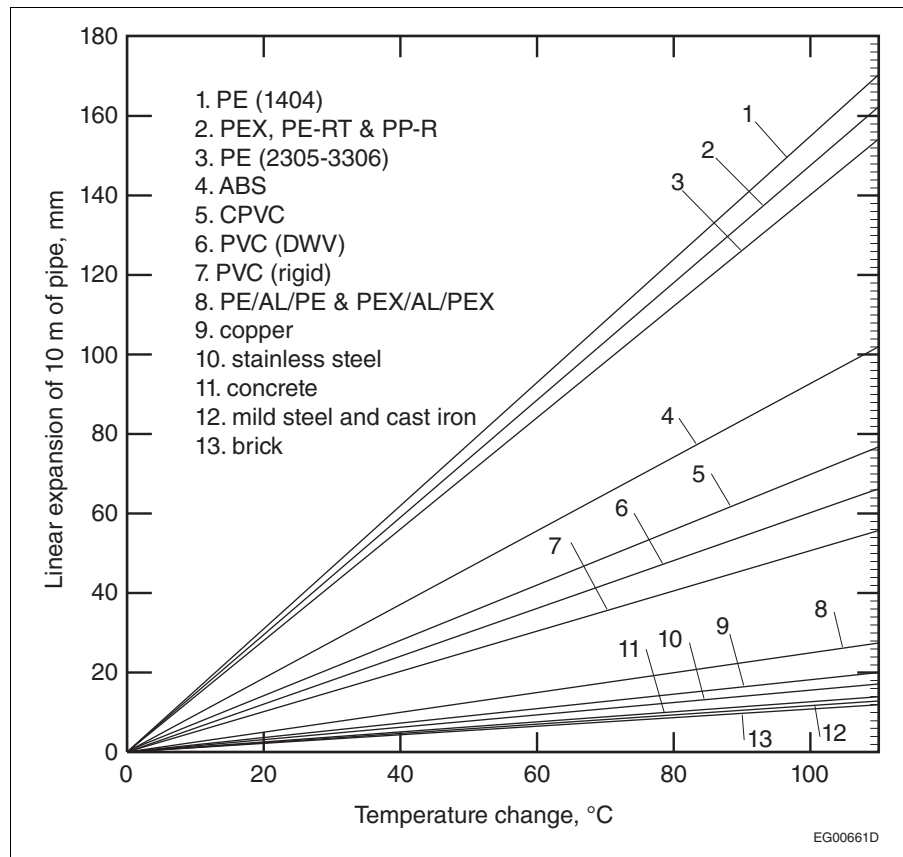


Figure A-2.3.3.9. Linear expansion

Example 1

To determine the expansion of 20 m of ABS pipe for a temperature change from 10°C to 60°C.

Temperature change = 60 – 10 = 50°C,

Enter the chart at 50°C, read up to ABS line, and then across to the mm scale = 47 mm/10 m of pipe,

∴ change in length of 20 m of pipe =  $\frac{20}{10} \times 47 = 94$  mm

**A-2.3.3.9.(1) Expansion and Contraction.** Expansion and contraction in piping systems may be accommodated in a number of ways including, but not limited to, piping design and layout, material selection, and the inclusion of expansion joints.

A-2.3.3.11.(2) Air Break.

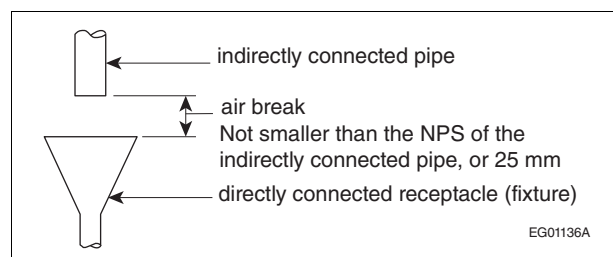
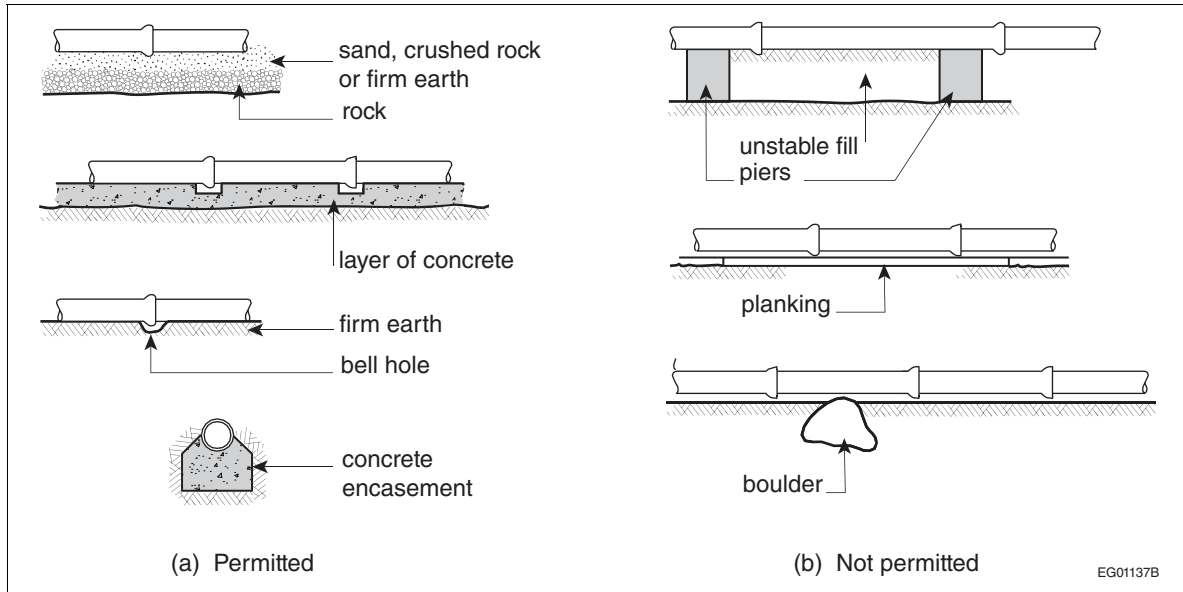


Figure A-2.3.3.11.(2) Air break

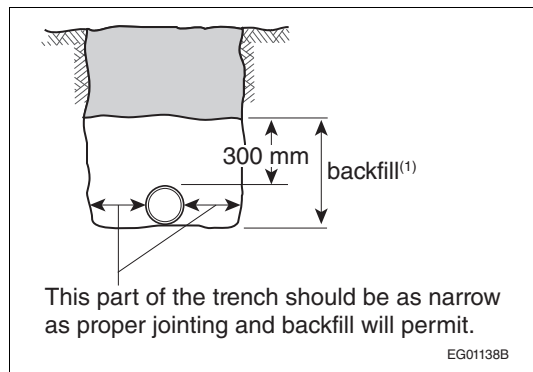


**A-2.3.4.6.(1) Support for Underground Piping.** See explanation for Subsection 2.3.5. for additional protection required for underground pipes. Permitted installations are shown in Figure A-2.3.4.6.(1)(a). The methods of support shown in Figure A-2.3.4.6.(1)(b) are not permitted because the base does not provide firm and continuous support for the pipe.



**Figure A-2.3.4.6.(1)**  
**Support for underground piping**

**A-2.3.5.1.(1)(a) Backfilling of Pipe Trench.** Stronger pipes may be required in deep fill or under driveways, parking lots, etc., and compaction for the full depth of the trench may be necessary.



**Figure A-2.3.5.1.(1)(a)**  
**Backfilling of pipe trench**

**Note to Figure A-2.3.5.1.(1)(a):**

(1) Backfill complying with Clause 2.3.5.1.(1)(a).

**A-2.3.5.3. Protection of Piping Against Freezing.** The TIAC 2013, “Mechanical Insulation Best Practices Guide” is a comprehensive source of information on the selection, installation and proper use of thermal insulation materials. (Note that Section 4 of this Guide is not included in the scope of this Note as it contains information on proprietary products, which are not within the mandate of the Code.)

**A-2.3.6.5.(1) Air Pressure Tests.** The addition of a non-toxic indicating substance, such as an aerosol, fluorescent dye, smoke or an odorant, to an air pressure test may help in identifying the location of a leak. However, the additive must be compatible with the piping material being tested: the intent is to identify the leak without affecting the outcome of the test or the integrity of the plumbing system.

**A-2.3.7.2.(2) Pressure-Testing of Potable Water Systems.** The plastic piping manufacturer should be consulted to determine the appropriateness of using air to pressure-test the piping system.

**A-2.4.2.1.(1)(a)(ii) and (e)(vi) Indirect Connections.** See Sentence 2.4.5.1.(4) for trapping requirements for indirectly connected fixtures.

See Sentence 2.4.7.1.(9) for cleanouts on drip pipes for food receptacles or display cases.

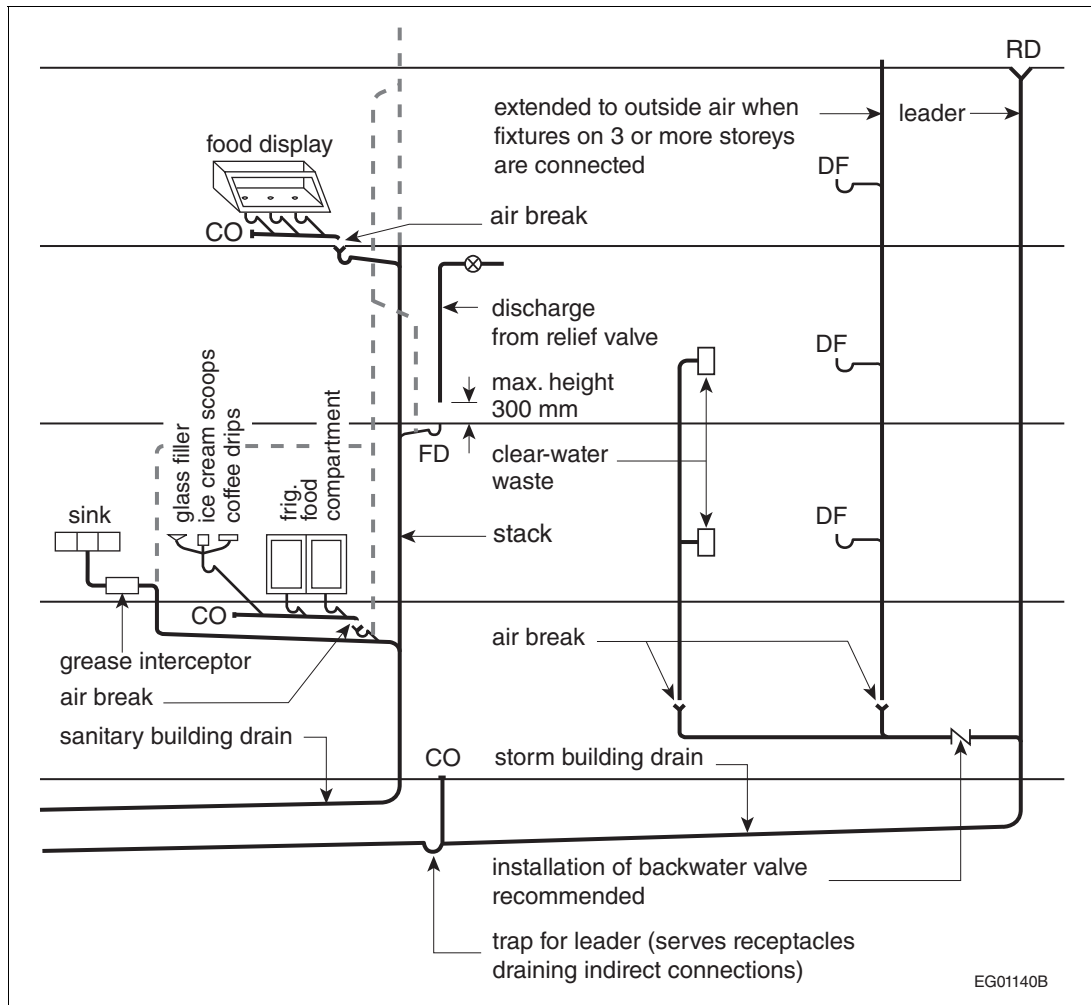
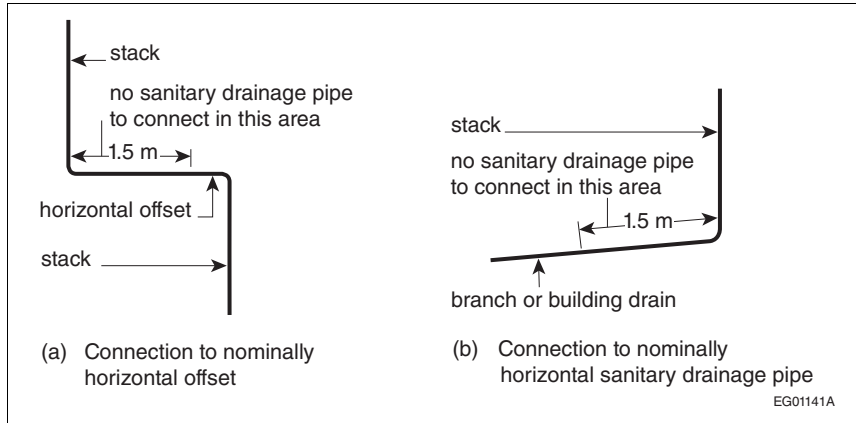


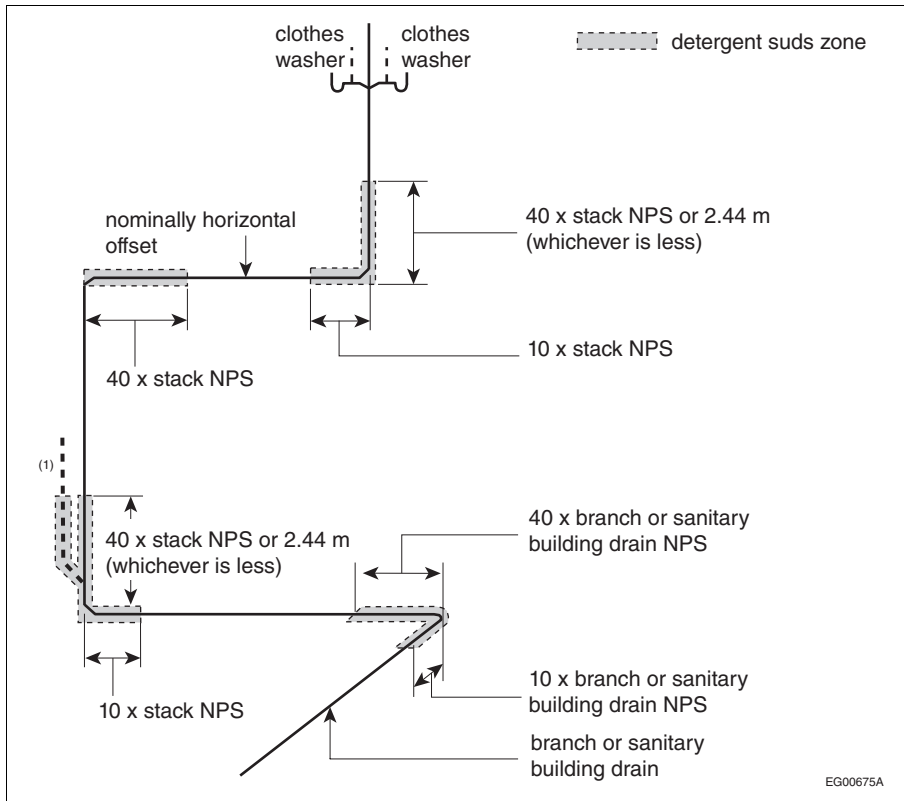
Figure A-2.4.2.1.(1)(a)(ii) and (e)(vi)  
Indirect connections

**A-2.4.2.1.(2) Sanitary Drainage Pipe Connections.**



**Figure A-2.4.2.1.(2)**  
**Sanitary drainage pipe connections**

**A-2.4.2.1.(4) and (5) Suds Pressure Zones.** High sudsing detergents used in clothes washers produce suds that tend to disrupt the venting action of venting systems and can also spread through the lower portions of multi-storey drainage systems. The more turbulence, the greater the suds. One solution that avoids the creation of suds pressure zones involves connecting the suds-producing stack downstream of all other stacks and increasing the size of the horizontal building drain to achieve a greater flow of air and water. Using streamlined fittings, such as wyes, tends to reduce suds formation. Check valves or backwater valves in fixture outlet pipes have also been used to correct problem installations.



**Figure A-2.4.2.1.(4) and (5)**  
**Suds pressure zones**

**Note to Figure A-2.4.2.1.(4) and (5):**  
(1) See Sentence 2.4.2.1.(5).

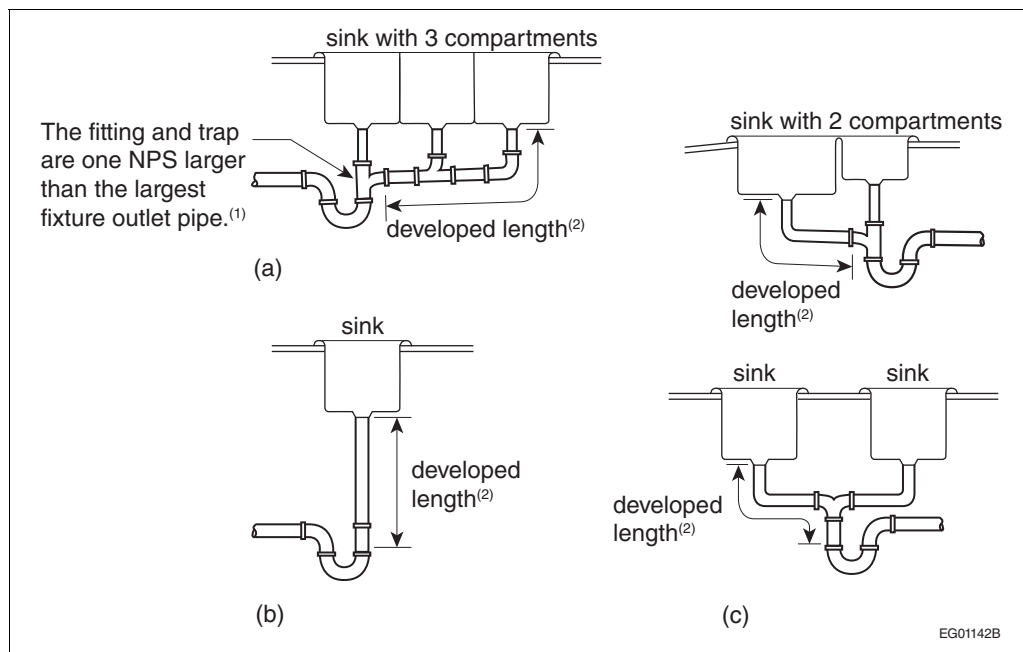
© His Majesty the King in Right of Canada, as represented by the National Research Council of Canada, 2025 © Sa Majesté le Roi du chef du Canada, représenté par le Conseil national de recherches du Canada, 2025

**A-2.4.3.3.(1) Waste with Organic Solids.** Equipment such as garbage grinders and potato peelers produces waste with organic solids. These devices reduce most waste into small-sized particles that will flow easily through the drainage system. However, if they are located upstream of the interceptor, the particles could block the interceptor.

**A-2.4.4.3.(1) Grease Interceptors.** Grease interceptors may be required when it is considered that the discharge of fats, oil or grease may impair the drainage system. Information on the design and sizing of grease interceptors can be found in ASPE 2012, "Plumbing Engineering Design Handbook, Volume 4, Chapter 8, Grease Interceptors."

**A-2.4.4.4.(1) Hazardous Waste.** Chemically loaded and bio-hazardous wastes can be dangerous to private or public sewer systems and hazardous to people. The treatment of corrosive and acid waste is mandated by this Code. The treatment of chemically loaded effluents is usually regulated by sewage collecting and treatment authorities. The treatment of bio-hazardous waste should follow "good engineering practice," such as that described in Laboratory Biosafety Guidelines published by Health Canada. It should be noted that bio-hazardous waste disposal systems require specific engineering expertise and remain outside the scope of this Code.

**A-2.4.5.1.(2) Trapping of Sinks and Laundry Trays.**



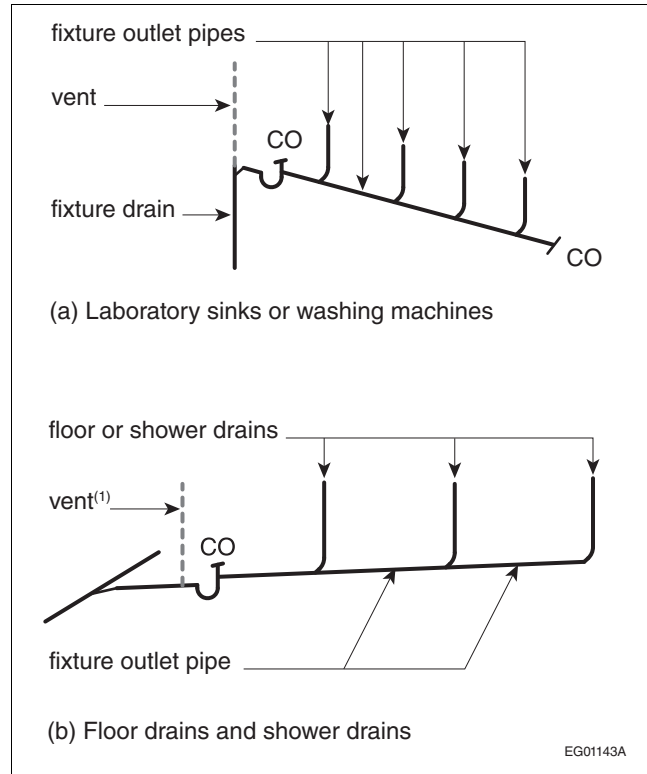
**Figure A-2.4.5.1.(2)**  
**Trapping of sinks and laundry trays**

**Notes to Figure A-2.4.5.1.(2):**

(1) See Sentence 2.4.9.3.(2).

(2) The developed length of the fixture outlet pipe must not exceed 1 200 mm. See Article 2.4.8.2.

**A-2.4.5.1.(3) Single Traps for Fixture Groups.**

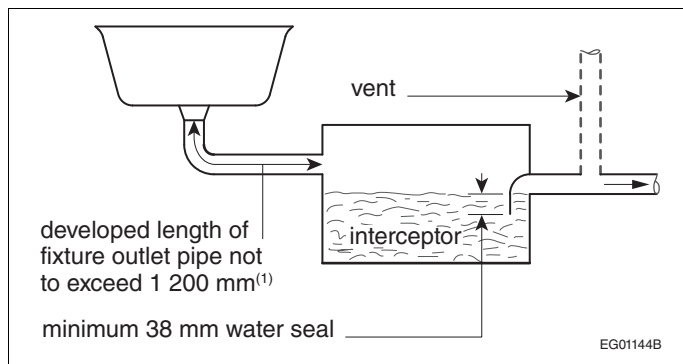


**Figure A-2.4.5.1.(3)**  
**Single traps for fixture groups**

**Note to Figure A-2.4.5.1.(3):**

(1) Vent not required for floor drains if the installation conforms to Sentence 2.5.1.1.(3).

**A-2.4.5.1.(5) Location of Trap or Interceptor.** An interceptor that replaces a trap must be vented in the same way as the trap it replaces. (See Note A-2.4.2.1.(1)(a)(ii) and (e)(vi).) Where an interceptor other than an oil interceptor serves a group of fixtures requiring more than one trap, each fixture must be properly trapped and vented. (See Article 2.5.5.2. for venting of oil interceptors.)



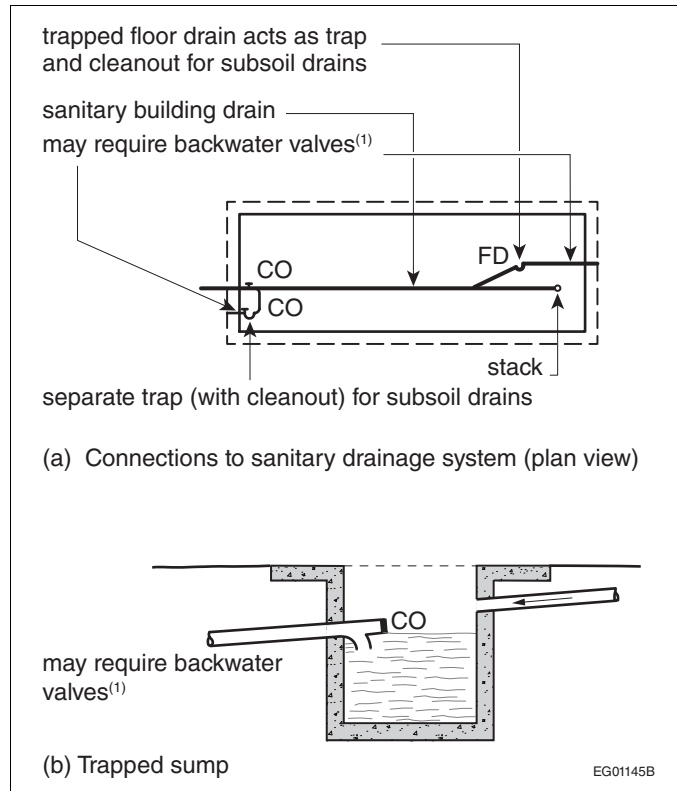
**Figure A-2.4.5.1.(5)**  
**Location of trap or interceptor**

**Note to Figure A-2.4.5.1.(5):**

(1) See Sentence 2.4.8.2.(1).

**A-2.4.5.2.(1) Untrapped Leader.** When an untrapped leader drains to a combined building sewer, clearance requirements are the same as for vent terminals. (See also Note A-2.5.6.5.(4).)

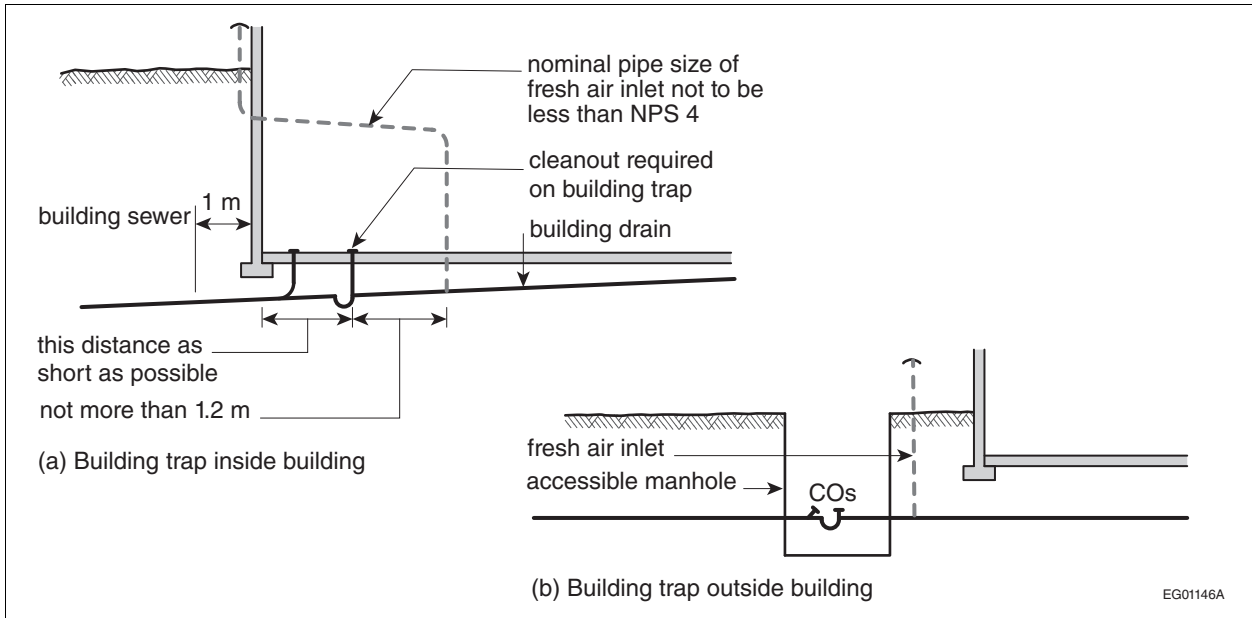
**A-2.4.5.3.(1) Subsoil Drainage Connections.** This Code does not regulate the installation of subsoil drainage pipes, but does regulate the connection of such pipes to the plumbing system. The intent of this Article is to place a trap between the subsoil drainage pipe and the sanitary drainage system. The cleanout must be installed in accordance with Sentence 2.4.7.1.(2). A trap or sump may be provided specifically for the subsoil drains, or advantage may be taken of the trap of a floor drain or storm water sump as shown in Figure A-2.4.5.3.(1).



**Figure A-2.4.5.3.(1)**  
**Subsoil drainage connections**

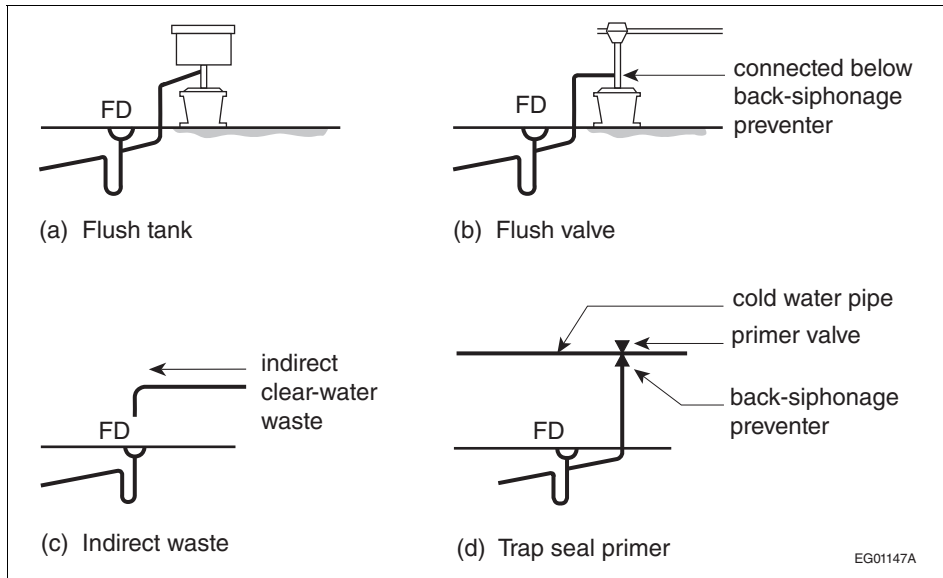
**Note to Figure A-2.4.5.3.(1):**  
(1) See Sentence 2.4.6.4.(5).

**A-2.4.5.4.(1) Location of Building Traps.**



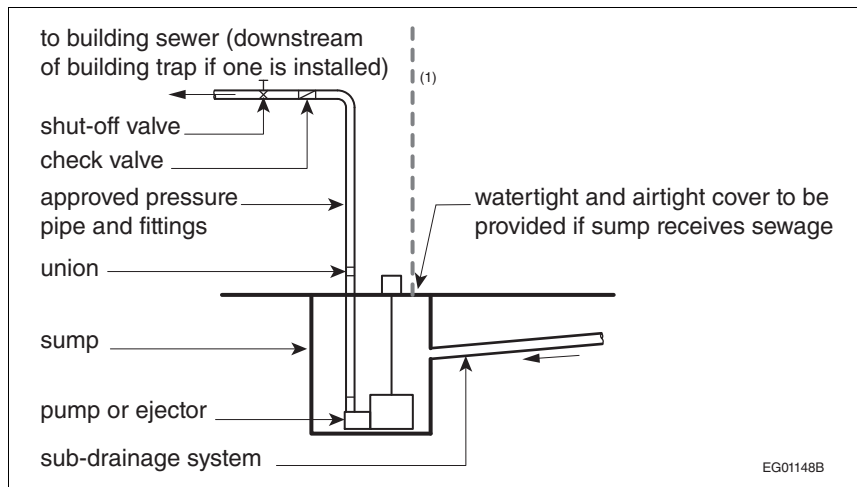
**Figure A-2.4.5.4.(1)**  
**Location of building traps**

**A-2.4.5.5.(1) Maintaining Trap Seals.** Periodic manual replenishment of the water in a trap is considered to be an equally effective means of maintaining the trap seal in floor drains in residences. Under pressure differential conditions, special measures are necessary to maintain trap seals.



**Figure A-2.4.5.5.(1)**  
**Maintaining trap seals**

**A-2.4.6.3. Arrangement of Piping at Sump.** In most installations, controls will be installed in conjunction with a float to automatically empty the sump. If such controls are not provided, the capacity of the sump should equal the maximum inflow to the sump that is expected to occur during any 24 h period.

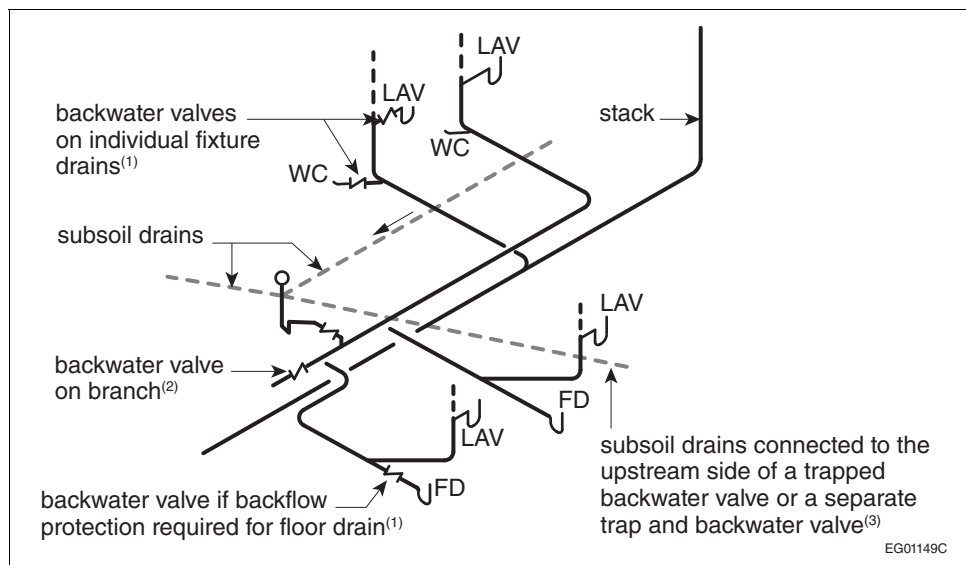


**Figure A-2.4.6.3.**  
**Arrangement of piping at sump**

**Note to Figure A-2.4.6.3.:**

- (1) See Article 2.5.7.7. for sizing of required vent if sump receives sewage.

**A-2.4.6.4.(1) Protection from Backflow Caused by Surge.** The requirement in Sentence 2.4.6.4.(1) is intended to apply when, in the opinion of the authority having jurisdiction, there is danger of backup from a public sewer.



**Figure A-2.4.6.4.(1)**  
**Protection from backflow caused by surge**

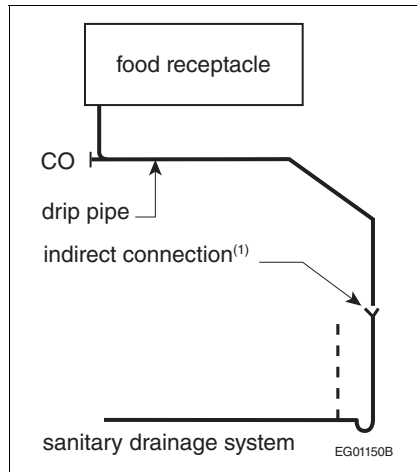
**Notes to Figure A-2.4.6.4.(1):**

- (1) See Sentence 2.4.6.4.(3).
- (2) See Sentence 2.4.6.4.(4).
- (3) See Sentence 2.4.6.4.(1).

**A-2.4.7.1.(6) Cleanouts for Drainage Systems.** To accommodate the limitations of sewer cleaning equipment, the cleanout should be located as close as possible to the exterior wall of the building, either inside or outside, and be accessible for sewer cleaning equipment.



**A-2.4.7.1.(9) Cleanouts for Food Receptacle Drip Pipes.**



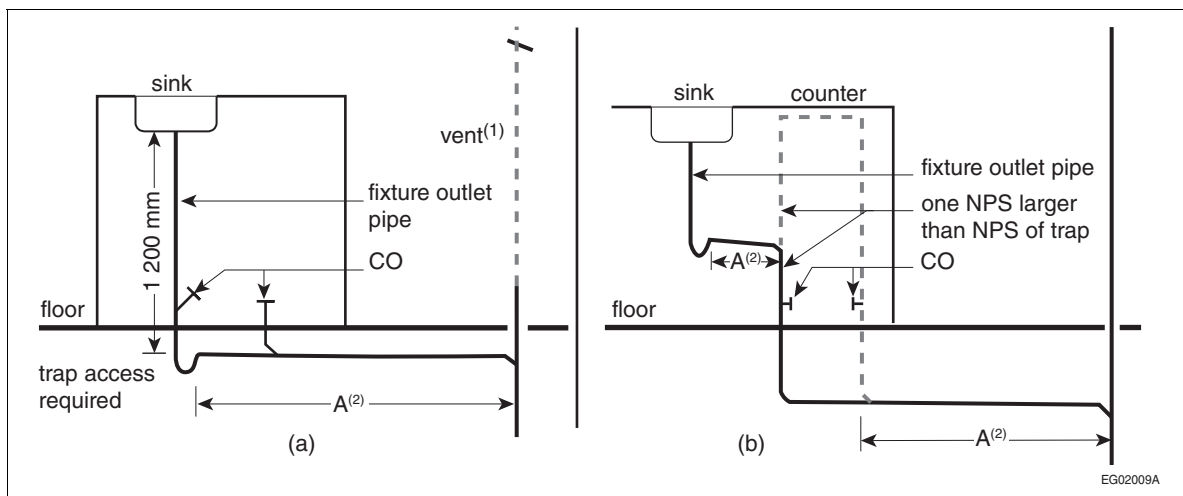
**Figure A-2.4.7.1.(9)**  
**Cleanouts for food receptacle drip pipes**

**Note to Figure A-2.4.7.1.(9):**  
 (1) See Article 2.4.2.1.

**A-2.4.7.1.(10) Cleanouts for Fixture Drains.** A trap cleanout plug cannot be used as a cleanout for a fixture drain.

**A-2.4.8.1.(1) Minimum Slope.** Although slopes below 1 in 100 are permitted for pipes over NPS 4, they should be used only where necessary. Steeper slopes and higher velocities will help to keep pipes clean by moving heavier solids that might tend to clog the pipes.

**A-2.4.8.2.(1) Island Fixture Installation.**



**Figure A-2.4.8.2.(1)**  
**Island fixture installation<sup>(3)</sup>**

**Notes to Figure A-2.4.8.2.(1):**

- (1) Nominal pipe size of vent to be in accordance with Article 2.5.6.3.
- (2) The fall of A cannot exceed the nominal pipe size of the fixture trap and its length depends on the nominal pipe size of the fixture trap:
  - for NPS 1½, A = 1.8 m
  - for NPS 2, A = 2.4 m
  - for NPS 3, A = 3.6 m
- (3) See also Article 2.5.1.1.

**A-Table 2.4.9.3. Hydraulic Loads for Laundry Traps and Floor Drains.** When determining the hydraulic load on a pipe, no allowance need be made for a load from a domestic clothes washer when discharged to a laundry tray since the hydraulic load from the laundry tray is sufficient. Also no hydraulic load is required from a floor drain in a washroom since it is for emergency use only.

**A-2.4.9.3.(2) Continuous Wastes.** Fixture outlet pipes that are common to 2 or 3 compartments or fixtures are sometimes referred to as continuous wastes and are not considered to be branches. (See also Note A-2.4.5.1.(2).)

**A-2.4.9.3.(3) Standpipe Illustration.**

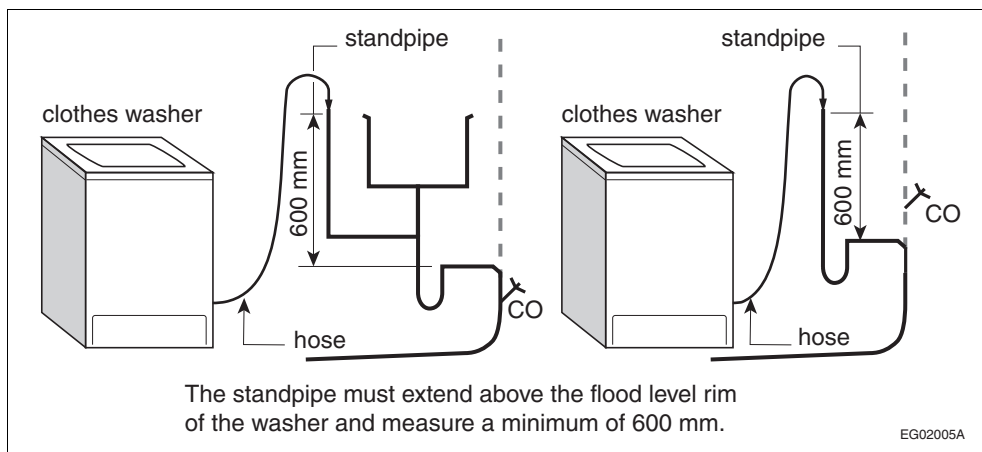


Figure A-2.4.9.3.(3)  
Standpipe installation for clothes washers

**A-2.4.10. Determination of Hydraulic Loads and Nominal Pipe Sizes of Drainage Pipes.**

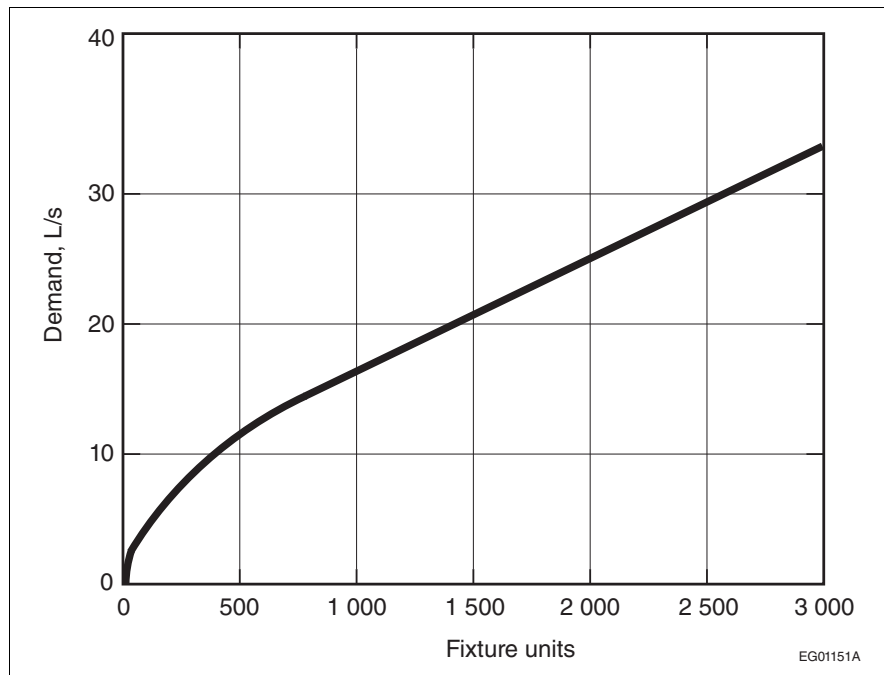
**Hydraulic Loads**

The hydraulic load that is imposed by a fixture is represented by a factor called a fixture unit. Fixture units are dimensionless and take into account the rate of discharge, time of discharge and frequency of discharge of the fixture.

Confusion often arises when attempts are made to convert fixture units to litres per second because there is no straightforward relationship between the two. The proportion of the total number of fixtures that can be expected to discharge simultaneously in a large system is smaller than in a small system. For example, doubling the number of fixtures in a system will not double the peak flow that the system must carry, although of course the flow will be increased somewhat. Figure A-2.4.10.-A shows the relationship that was used in constructing the tables of capacities of stacks, branches, sanitary building drains and sanitary building sewers (Tables 2.4.10.6.-A to 2.4.10.6.-C).

Although the curve in Figure A-2.4.10.-A was used to prepare the Code tables, it was not included in the National Plumbing Code. Instead, a single approximate conversion factor is given in the Code so that a continuous flow from a fixture may be converted from litres per second to fixture units in order to determine the total hydraulic load on the sanitary drainage system. The conversion factor, which is given in Sentence 2.4.10.3.(1), is 31.7 fixture units per litres per second. The discharge from a continuous flow fixture in litres per second when multiplied by 31.7 gives the hydraulic load in fixture units, and that load is added to the fixture unit load from other fixtures to give the total load that the sanitary drainage pipe must carry.

The hydraulic load that is produced by storm water runoff depends both on the size of the area that is drained and local rainfall intensity. The capacities of storm drainage pipes and combined sewers in Tables 2.4.10.9., 2.4.10.10. and 2.4.10.11. have been expressed in terms of the number of litres that they can carry when the local rainfall intensity is 1 mm in 15 min. The hydraulic load for a particular location is obtained by simply multiplying the rainfall intensity figure given in Appendix C of Division B of the NBC by the actual area drained as specified in Sentence 2.4.10.4.(1).



**Figure A-2.4.10-A**  
**Relationship between fixture units and demand**

In the case of restricted-flow drains, the hydraulic load from storm water runoff must be calculated using manufacturer discharge flow rates of specific drains in the case of roofs, and water-flow restrictors in the case of paved areas.

When plumbing fixtures are connected to a combined sewer, the hydraulic load from the fixtures must be converted from fixture units to litres or, in the case of continuous flow, from litres per second to litres so that these loads can be added to the hydraulic loads from roofs and paved surfaces. As already pointed out, the relationship between fixture units and litres per second and, consequently, the relationship between fixture units and litres is not straightforward, and an approximate conversion factor has been adopted. The conversion factor given in Sentence 2.4.10.5.(1) is 9.1 L/fixture unit, except where the load is less than 260 fixture units in which case a round figure of 2 360 L is to be used. In the case of continuous-flow fixtures that are connected to combined sewers or storm sewers, the conversion factor given in Sentence 2.4.10.3.(2) is 900 L per L/s. This conversion factor is not an approximation but an exact calculation.

The conversion factors given in Sentences 2.4.10.3.(1) and 2.4.10.5.(1) are designed to convert in one direction only, and must not be used to convert from fixture units to litres per second in the one instance, nor from litres to fixture units in the other instance.

In summary, it should be noted that

- (a) in sanitary drainage systems, all hydraulic loads are converted to fixture units, and
- (b) in storm drainage systems or combined drainage systems, all hydraulic loads are converted to litres.

### Procedure for Selecting Nominal Pipe Sizes

The following is an outline, with examples, of the procedures to be followed in determining the nominal pipe size of each section of drainage piping.

- (1) Sanitary drainage pipes, such as branches, stacks, building drains or building sewers:
  - (a) Determine the load in fixture units from all fixtures except continuous-flow fixtures;
  - (b) Determine the load in litres per second from all continuous-flow fixtures and multiply the number of litres per second by 31.7 to obtain the number of fixture units;
  - (c) Add loads (a) and (b) to obtain the total hydraulic load on the pipe in fixture units; and
  - (d) Consult the appropriate table from Table 2.4.10.6.-A, 2.4.10.6.-B or 2.4.10.6.-C to select the nominal pipe size.

(Note that no pipe may be smaller than the NPS permitted in Subsection 2.4.9.)

- (2) Storm drainage pipes, such as gutters, leaders, horizontal pipes, building drains or building sewers:

- (a) Determine the area in square metres of roofs and paved surfaces according to Sentence 2.4.10.4.(1);
- (b) Determine the local rainfall intensity (15 min rainfall) from Appendix C of Division B of the NBC;
- (c) Multiply (a) by (b) to obtain the hydraulic load in litres;
- (d) If a fixture discharges a continuous flow to the storm system, multiply its load in litres per second by 900 to obtain the hydraulic load in litres;
- (e) If flow control roof drains are used, compute the discharge rate based on rain intensity, retention duration, accumulation height and roof area from the roof drain manufacturers' data;
- (f) Add loads (c) or (e), and (d) to obtain the total hydraulic load on the pipe in litres; and
- (g) Consult the appropriate table from Table 2.4.10.9., 2.4.10.10. or 2.4.10.11. to select the nominal pipe size of the pipe or gutter.

(Note that no pipe may be smaller than the NPS permitted in Subsection 2.4.9.)

- (3) Combined drainage pipes, such as building sewers:
  - (a) Determine the total load in fixture units from all fixtures except continuous-flow fixtures;
  - (b) If the fixture unit load exceeds 260, multiply it by 9.1 to determine the equivalent hydraulic load in litres. If the fixture unit load is 260 or fewer fixture units, the hydraulic load is 2 360 L;
  - (c) Obtain the hydraulic load from roofs and paved surfaces in the same manner as for storm drains (see 2(a), (b), (c) and (e));
  - (d) Obtain the hydraulic load in litres from any continuous-flow source that is connected to the sanitary or storm drainage system in the same manner as for storm drainage pipes (see 2(d));
  - (e) Add hydraulic loads (b), (c) and (d) to obtain the total hydraulic load on the pipe in litres; and
  - (f) Consult Table 2.4.10.9. to select the nominal pipe size.

(Note that no pipe may be smaller than the NPS permitted in Subsection 2.4.9.)

**Examples**

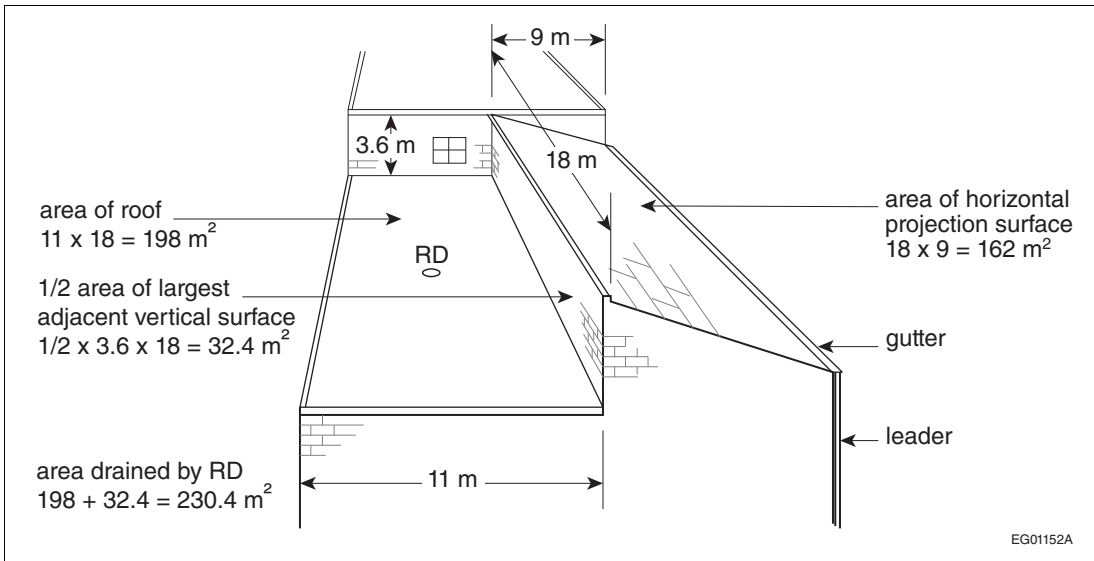
**Example 1: Determination of the nominal pipe size of storm drainage components for the building shown in Figures 1-1 and 1-2**

Step No. 1: Determine the hydraulic load from the roofs.

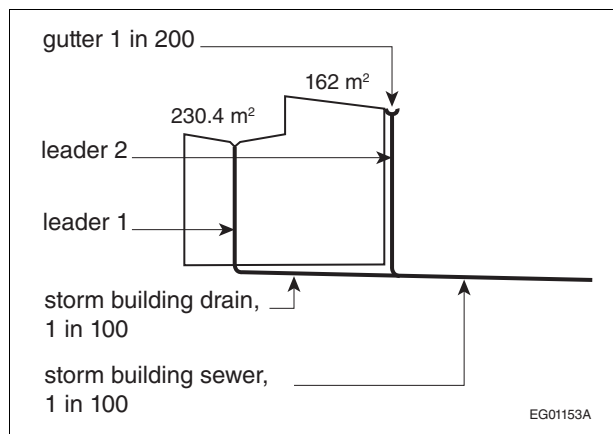
Area drained by gutter	= 162 m <sup>2</sup>
Area drained by roof drain	= 230.4 m <sup>2</sup>
If the local rainfall intensity is 25 mm:	
the load on the gutter (leader No. 2) is (25 × 162)	= 4 050 L
the load on the roof drain (leader No. 1) is (25 × 230.4)	= 5 760 L
If the local rainfall intensity is 15 mm:	
the load on the gutter (leader No. 2) is (15 × 162)	= 2 430 L
the load on the roof drain (leader No. 1) is (15 × 230.4)	= 3 456 L

Step No. 2: Determine the nominal pipe size of storm drainage components.

Using the appropriate hydraulic loads, the nominal pipe size of storm drainage components can be determined from Tables 2.4.10.9., 2.4.10.10. and 2.4.10.11. These values are tabulated in Table 1-2 for rainfall intensities of 25 mm and 15 mm in 15 min.



**Figure 1-1**  
**Storm drainage areas (example 1)**



**Figure 1-2**  
**Storm drainage components (example 1) (elevation view)**

**Table 1-2**  
**Nominal Pipe Sizes of Storm Drainage Pipes (Example 1)**

Storm Drainage Pipes	Area Drained, m <sup>2</sup>	15-min Rainfall Intensity, mm				NPC Reference Table No.
		25		15		
		Hydraulic Load, L	Nominal Pipe Size, NPS	Hydraulic Load, L	Nominal Pipe Size, NPS	
Roof drain leader	230.4	5 760	4	3 456	3	2.4.10.11.
Gutter	162	4 050	8	2 430	7	2.4.10.10.
Gutter leader	162	4 050	3	2 430	2½	2.4.10.11.
Storm building drain	230.4	5 760	5	3 456	4	2.4.10.9.
Storm building sewer	395.8	9 895	6	5 936	5	2.4.10.9.

**Example 2: Determination of the nominal pipe size of drainage pipes for buildings**

Figure 2-1 represents an office building with washrooms for men and women, a drinking fountain and cleaner's closet on each typical floor. The equipment room with facilities is located in the basement. The building is 18 m by 30 m and is to be built in Kitchener, Ontario.

**A. Hydraulic Load per Typical Floor**

5 WC @ 6	=	30	fixture units
2 UR @ 1½	=	3	fixture units
4 LAV @ 1½	=	6	fixture units
2 FD @ 3	=	6	fixture units
1 FS @ 3	=	3	fixture units
1 DF @ 1	=	1	fixture unit
		49	fixture units

The reader is left to calculate the nominal pipe size of the branches, one of which must be NPS 4 and another NPS 3 (see Subsection 2.4.9.). Therefore the smallest part of the stack must be NPS 4.

**B. Hydraulic Load on Stack**

5 storeys @ 49 fixture units = 245 fixture units

Table 2.4.10.6.-A permits NPS 4 pipe. Use NPS 4 pipe.

**C. Hydraulic Load on Basement Branch**

1 WC @ 6	=	6	fixture units
1 LAV @ 1	=	1	fixture unit
2 FD @ 3	=	6	fixture units
1 FS @ 3	=	3	fixture units
Semi-continuous Flow			
0.23 L/s × 31.7	=	7	fixture units
		23	fixture units

Table 2.4.10.6.-B permits NPS 3 pipe. Use NPS 3 pipe.

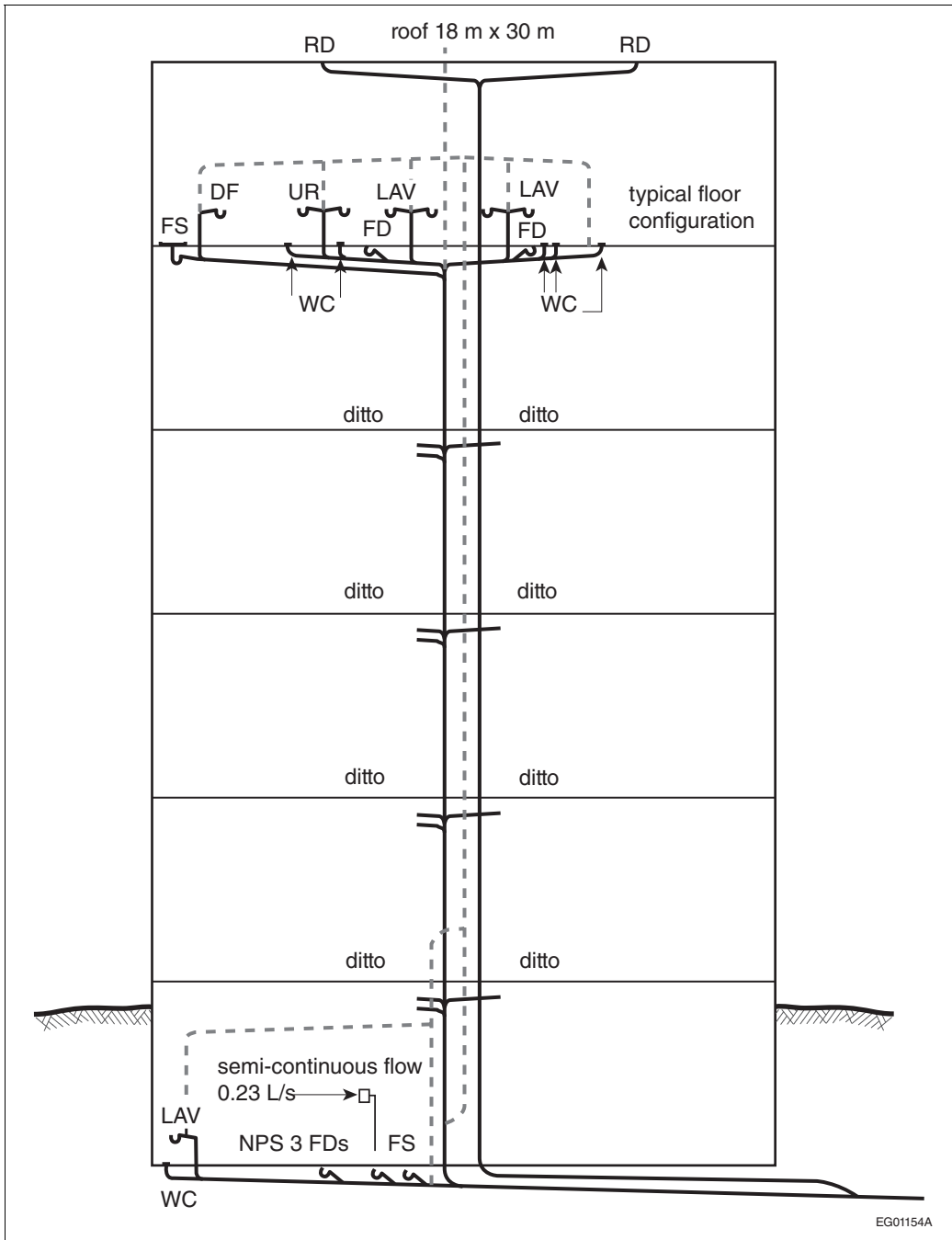
**D. Hydraulic Load on Building Drain**

From stack		245	fixture units
From basement branch		23	fixture units
		268	fixture units

Referring to Table 2.4.10.6.-C, at a slope of 1 in 50, an NPS 4 pipe will carry 240 fixture units.

Referring to Table 2.4.10.6.-C, at a slope of 1 in 25, an NPS 4 pipe will carry 300 fixture units.

For practical reasons, use an NPS 4 pipe at a slope of not less than 1 in 32.



**Figure 2-1**  
**Building drainage system (example 2)**

**E. Storm Load**

Area of roof  $18 \times 30 = 540 \text{ m}^2$

Rainfall intensity for Kitchener, taken from Appendix C of Division B of the NBC, is 28 mm in 15 min

Total hydraulic storm load =  $28 \times 540 = 15\,120 \text{ L}$

Storm load on each roof drain =  $15\,120/2 = 7\,560 \text{ L}$

**F. Nominal Pipe Size of Horizontal Leaders**

Referring to Table 2.4.10.9., at a slope of 1 in 25, an NPS 4 pipe will carry a load of 8 430 L.

Referring to Table 2.4.10.9., at a slope of 1 in 100, an NPS 5 pipe will carry a load of 7 650 L.

Referring to Table 2.4.10.9., at a slope of 1 in 133, an NPS 6 pipe will carry a load of 10 700 L.

Therefore, use an NPS 5 pipe at a slope of 1 in 100.

**G. Nominal Pipe Size of Vertical Leader**

Table 2.4.10.11. would permit an NPS 5 pipe (19 500 L) but this nominal pipe size is not readily available. For practical reasons, use an NPS 6 pipe.

**H. Nominal Pipe Size of Storm Building Drains**

Since a drainage pipe cannot be any smaller than any upstream pipes, the storm building drain must be at least NPS 6 . Referring again to Table 2.4.10.9., an NPS 6 pipe will carry a hydraulic load of 17 600 L at a slope of 1 in 50. Therefore use an NPS 6 pipe at a slightly higher slope.

**I. Nominal Pipe Size of Combined Building Sewer**

- (a) Total sanitary load excluding semi-continuous flow 260 fixture units converted to litres (Clause 2.4.10.5.(1)(b))  $\times 9.1 = 2\,366$  L
- (b) Semi-continuous flow 0.23 L/s converted to litres (Sentence 2.4.10.3.(2))  $\times 900 = 207$  L
- (c) Storm load 15 120 L

Total hydraulic load 17 693 L

Referring to Table 2.4.10.9., at a slope of 1 in 50, an NPS 6 pipe will carry 17 600 L.

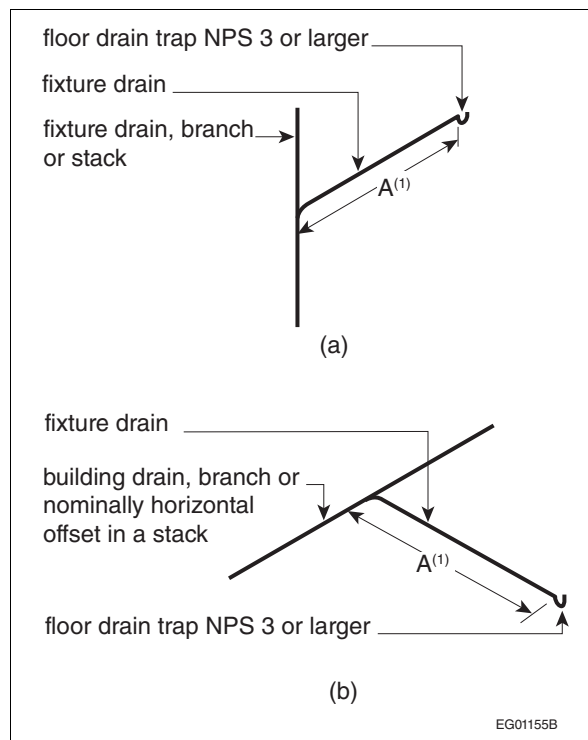
Referring to Table 2.4.10.9., at a slope of 1 in 25, an NPS 6 pipe will carry 24 900 L.

Therefore, use an NPS 6 pipe at a slope of not less than 1 in 32.

**A-2.4.10.4.(1) Rainfall Intensities.** Climate information on rainfall intensities for various cities can be found in Appendix C of Division B of the NBC.

When calculating the hydraulic load from a roof or paved surface, it should be noted that a 1 mm depth of water on 1 m<sup>2</sup> of surface is equivalent to 1 L.

**A-2.5.1.1.(3) Trapping of Floor Drains.**



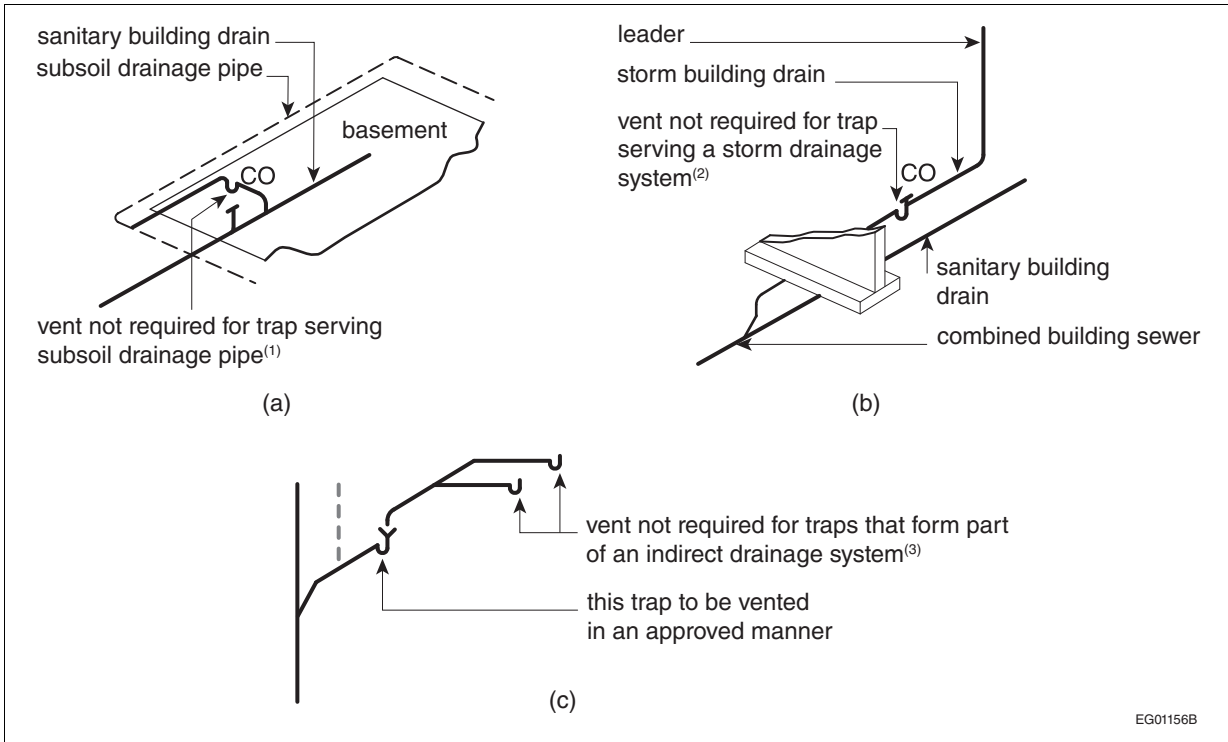
**Figure A-2.5.1.1.(3)**  
**Trapping of floor drains**

**Note to Figure A-2.5.1.1.(3):**

- (1) Length of "A" must be at least 450 mm and its fall must not exceed the NPS of the pipe. See also the explanation given in Sentence 2.5.6.3.(1) regarding the fall on fixture drains.



**A-2.5.1.1.(4) Venting not Required.**



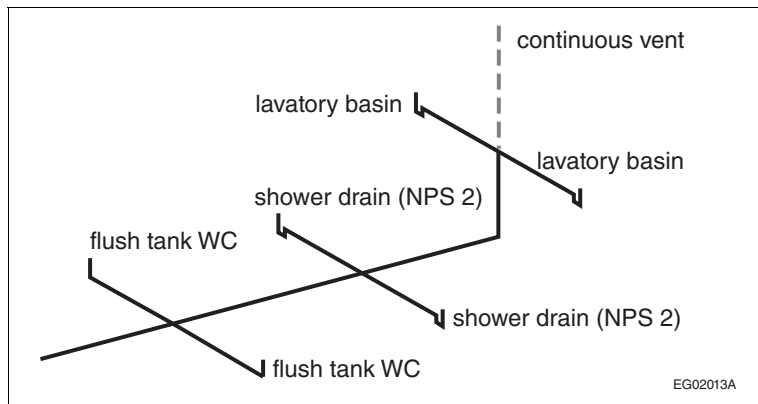
**Figure A-2.5.1.1.(4)**  
**Venting not required**

**Notes to Figure A-2.5.1.1.(4):**

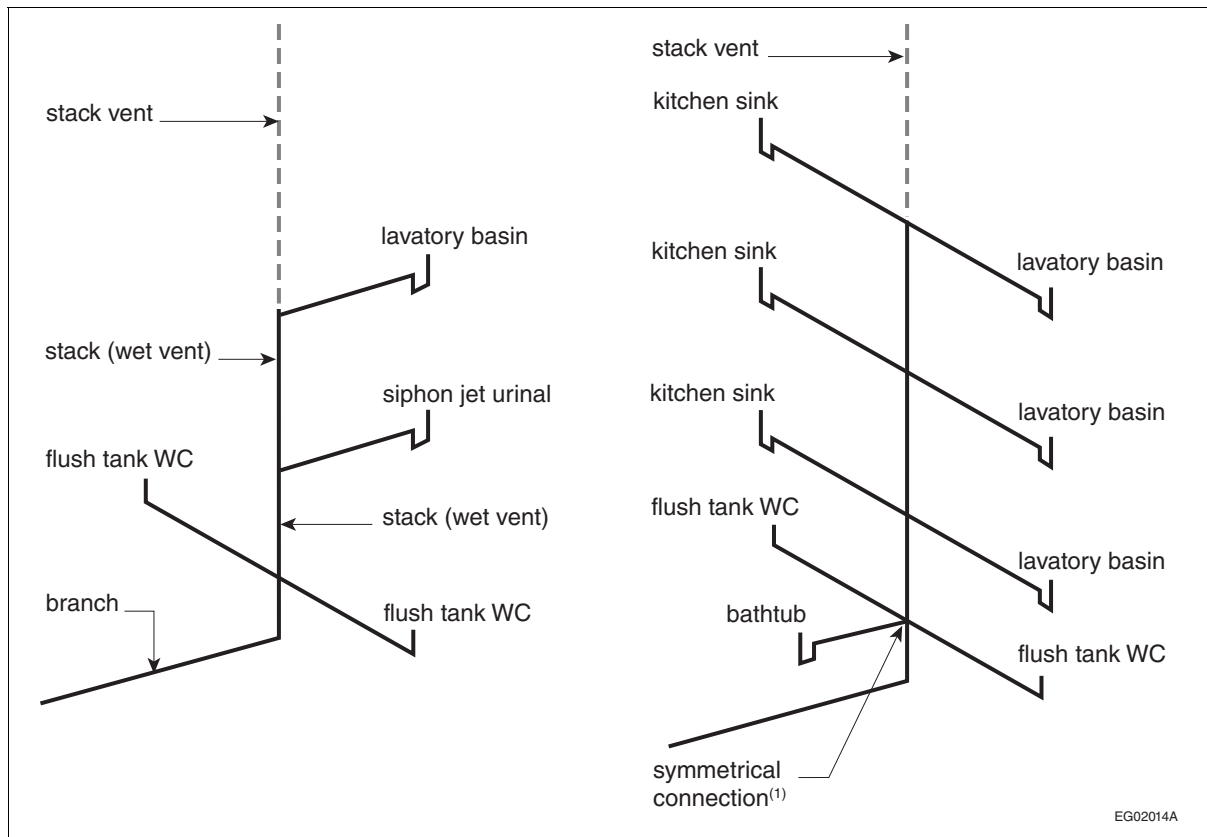
- (1) See Subclause 2.5.1.1.(4)(a)(i).
- (2) See Subclause 2.5.1.1.(4)(a)(ii).
- (3) See Clause 2.5.1.1.(4)(b).

**A-2.5.2.1. Wet Venting.** Single-storey and multi-storey wet venting has been replaced with wet venting (Article 2.5.2.1.) and circuit venting (Article 2.5.3.1.).

The information and figures presented in this Note are examples of the most common installation practices that meet NPC requirements. However, the examples shown do not preclude other installations that would also conform to NPC requirements.



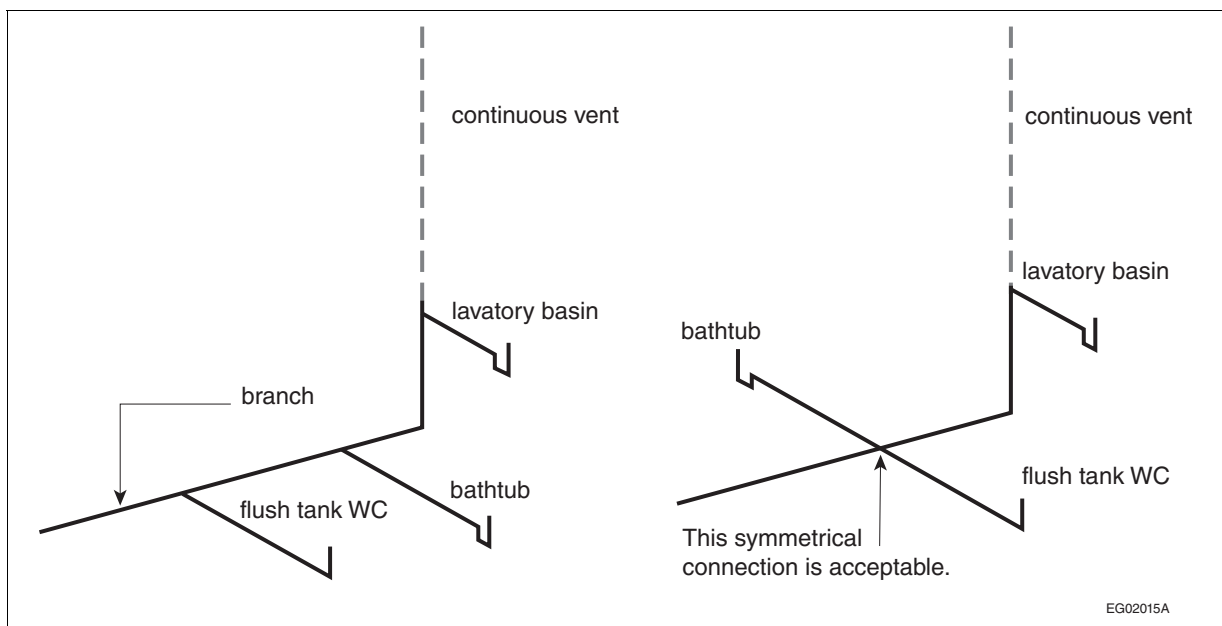
**Figure A-2.5.2.1.-A**  
**Example of wet venting described in Clause 2.5.2.1.(1)(b)**



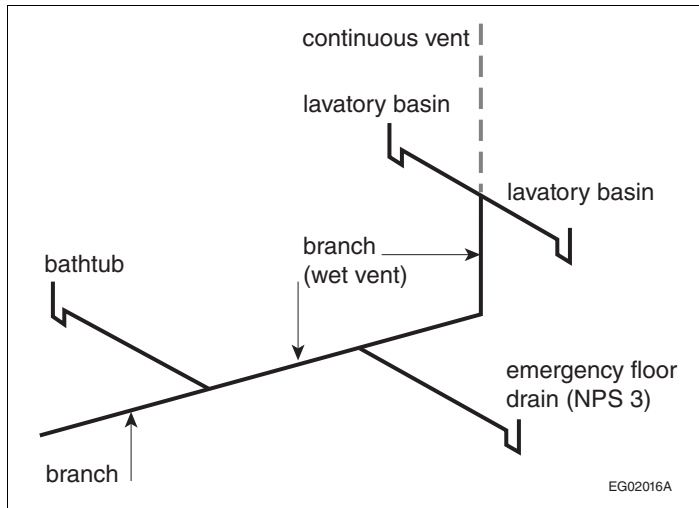
**Figure A-2.5.2.1-B**  
**Example of wet venting described in Clause 2.5.2.1.(1)(c)**

**Note to Figure A-2.5.2.1-B:**

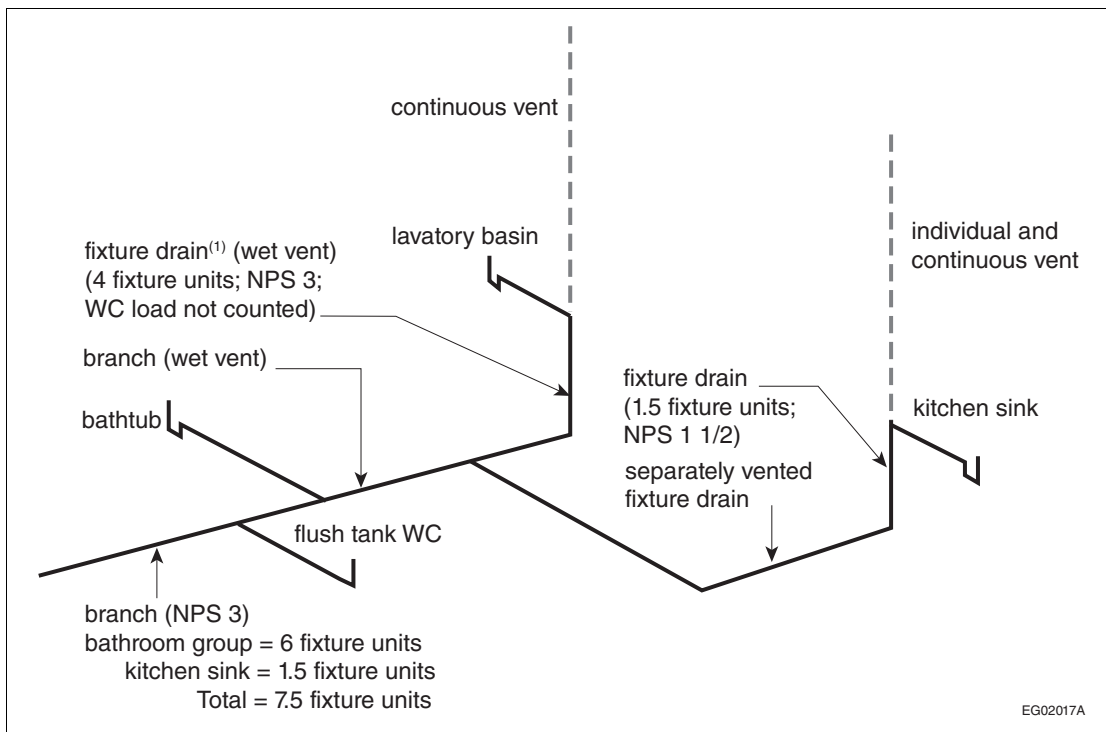
- (1) A symmetrical connection is accomplished with a manufactured fitting that has two or more inlets and connects two or more waste lines to a vent or wet vent.



**Figure A-2.5.2.1-C**  
**Example of wet venting described in Clause 2.5.2.1.(1)(d)**



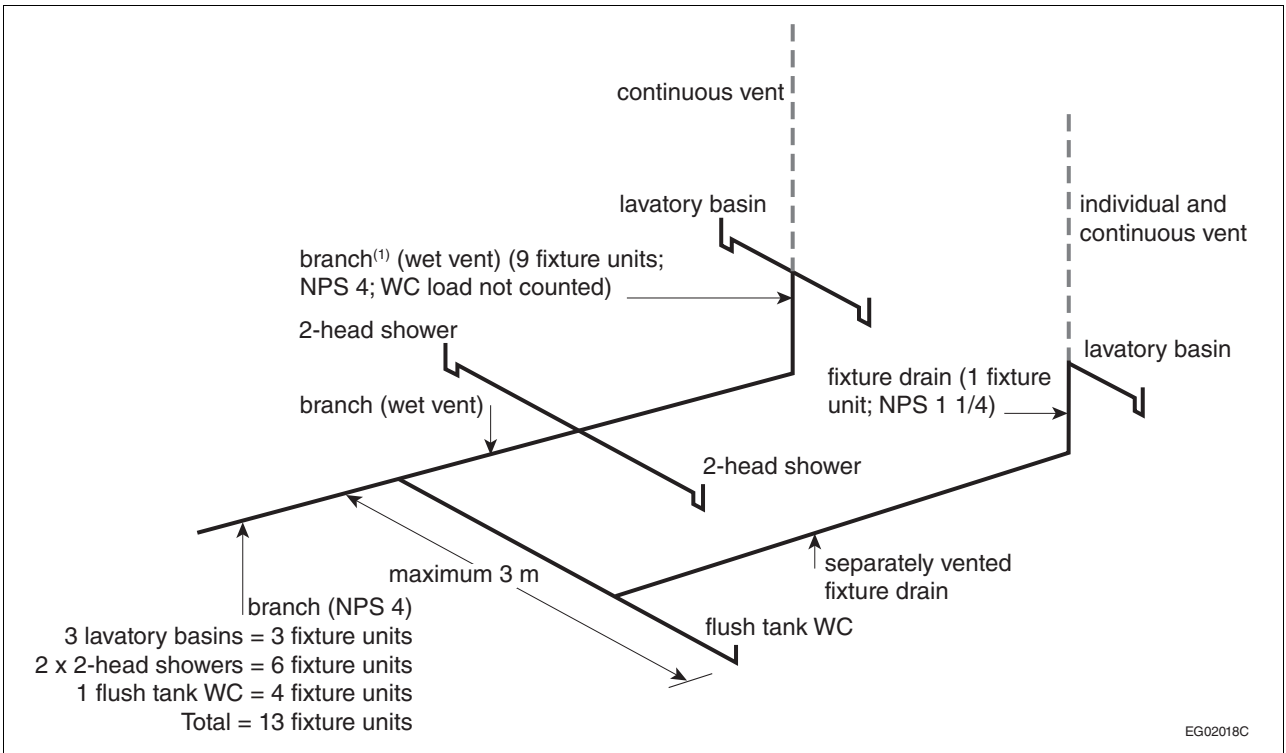
**Figure A-2.5.2.1-D**  
**Example of wet venting described in Clause 2.5.2.1.(1)(e)**



**Figure A-2.5.2.1-E**  
**Example of wet venting described in Clause 2.5.2.1.(1)(f)**

**Note to Figure A-2.5.2.1-E:**

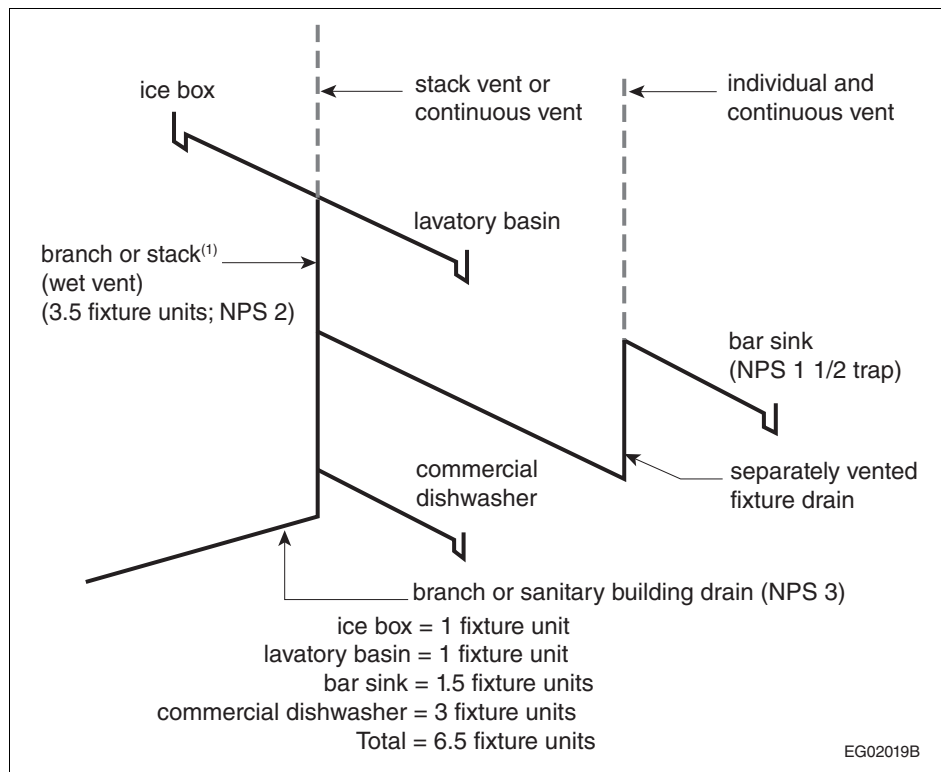
(1) The load from the separately vented kitchen sink is included when sizing this pipe.



**Figure A-2.5.2.1-F**  
**Example of wet venting described in Clause 2.5.2.1.(1)(f)**

**Note to Figure A-2.5.2.1-F:**

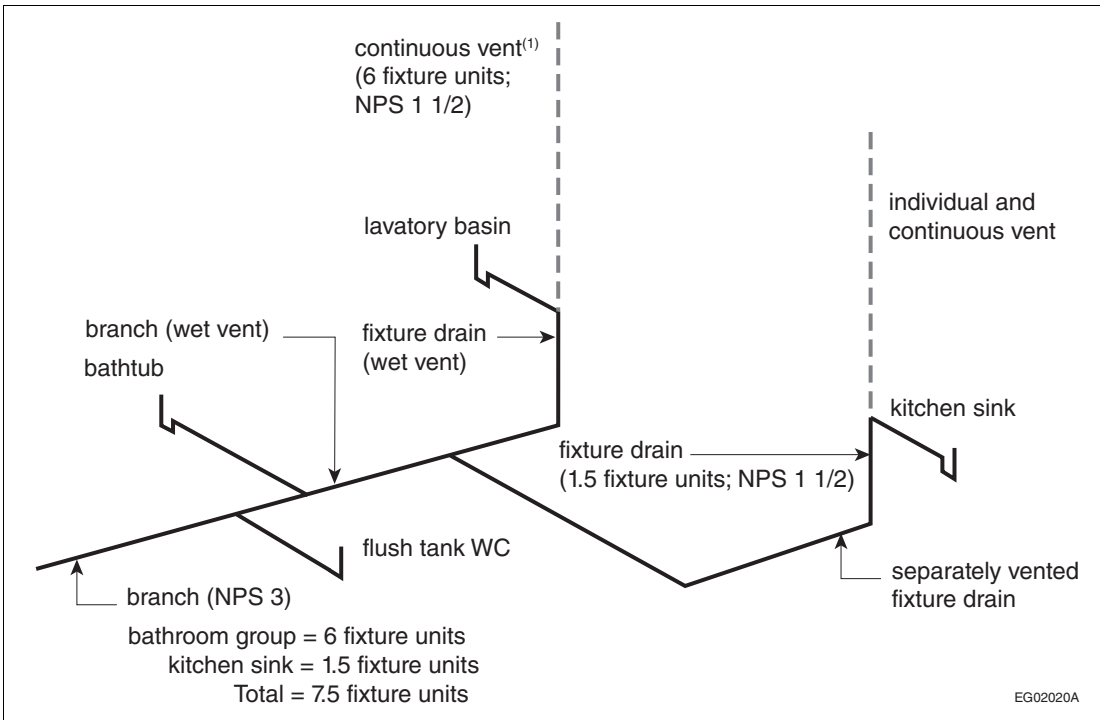
(1) The load from the separately vented lavatory basin is included when sizing this pipe.



**Figure A-2.5.2.1-G**  
**Example of wet venting described in Clause 2.5.2.1.(1)(f)**

**Note to Figure A-2.5.2.1-G:**

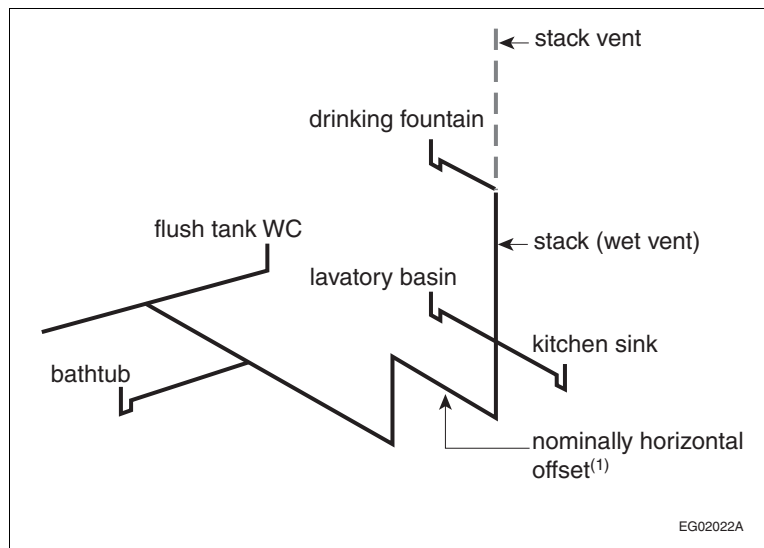
(1) The load from the separately vented bar sink is included when sizing this pipe.



**Figure A-2.5.2.1.-H**  
Example of wet venting described in Clause 2.5.2.1.(1)(g)

**Note to Figure A-2.5.2.1.-H:**

(1) The load from the separately vented kitchen sink is not included when sizing this pipe.



**Figure A-2.5.2.1.-I**  
Example of wet venting described in Clause 2.5.2.1.(1)(i)

**Note to Figure A-2.5.2.1.-I:**

(1) "Offset" means the piping that connects the ends of 2 pipes that are parallel.

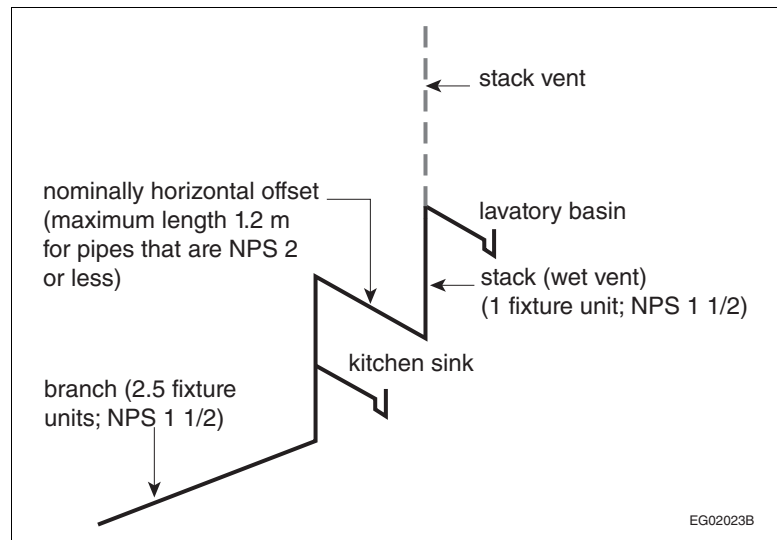


Figure A-2.5.2.1.-J  
Example of wet venting described in Subclause 2.5.2.1.(1)(i)(i)

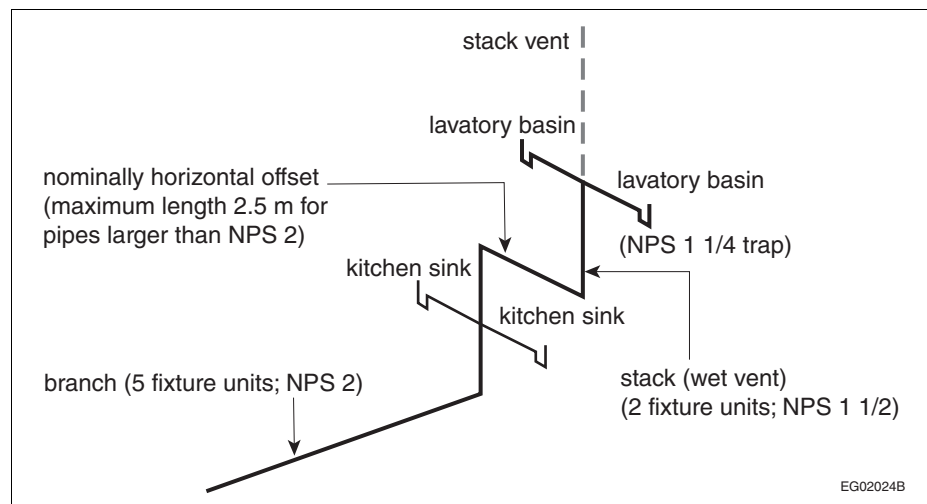


Figure A-2.5.2.1.-K  
Example of wet venting described in Subclause 2.5.2.1.(1)(i)(ii)

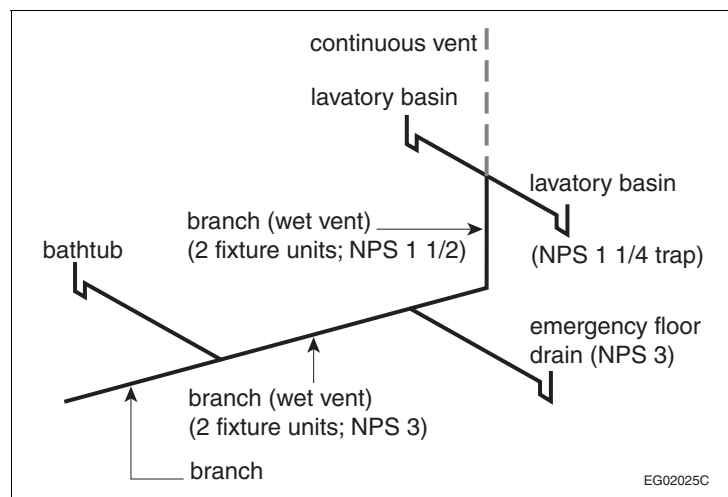
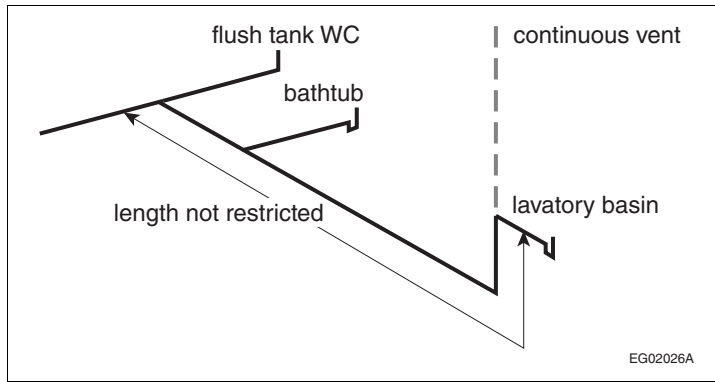


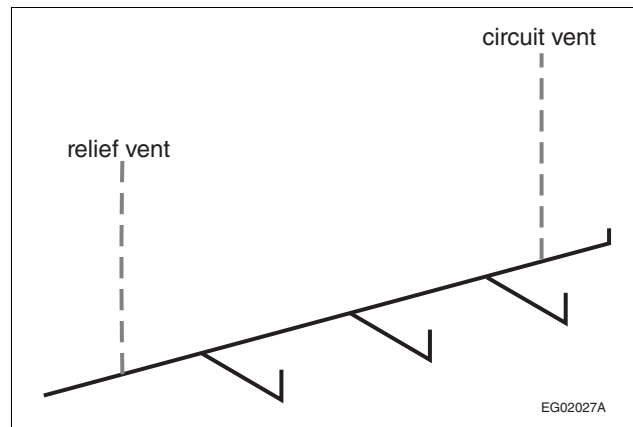
Figure A-2.5.2.1.-L  
Example of wet venting described in Clause 2.5.2.1.(1)(j)



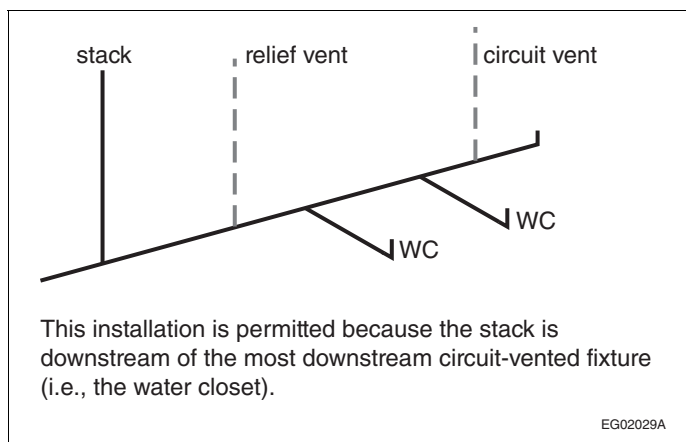
**Figure A-2.5.2.1.-M**  
**Example of wet venting described in Clause 2.5.2.1.(1)(k)**

**A-2.5.3.1. Circuit Venting.** Single-storey and multi-storey wet venting has been replaced with wet venting (Article 2.5.2.1.) and circuit venting (Article 2.5.3.1.).

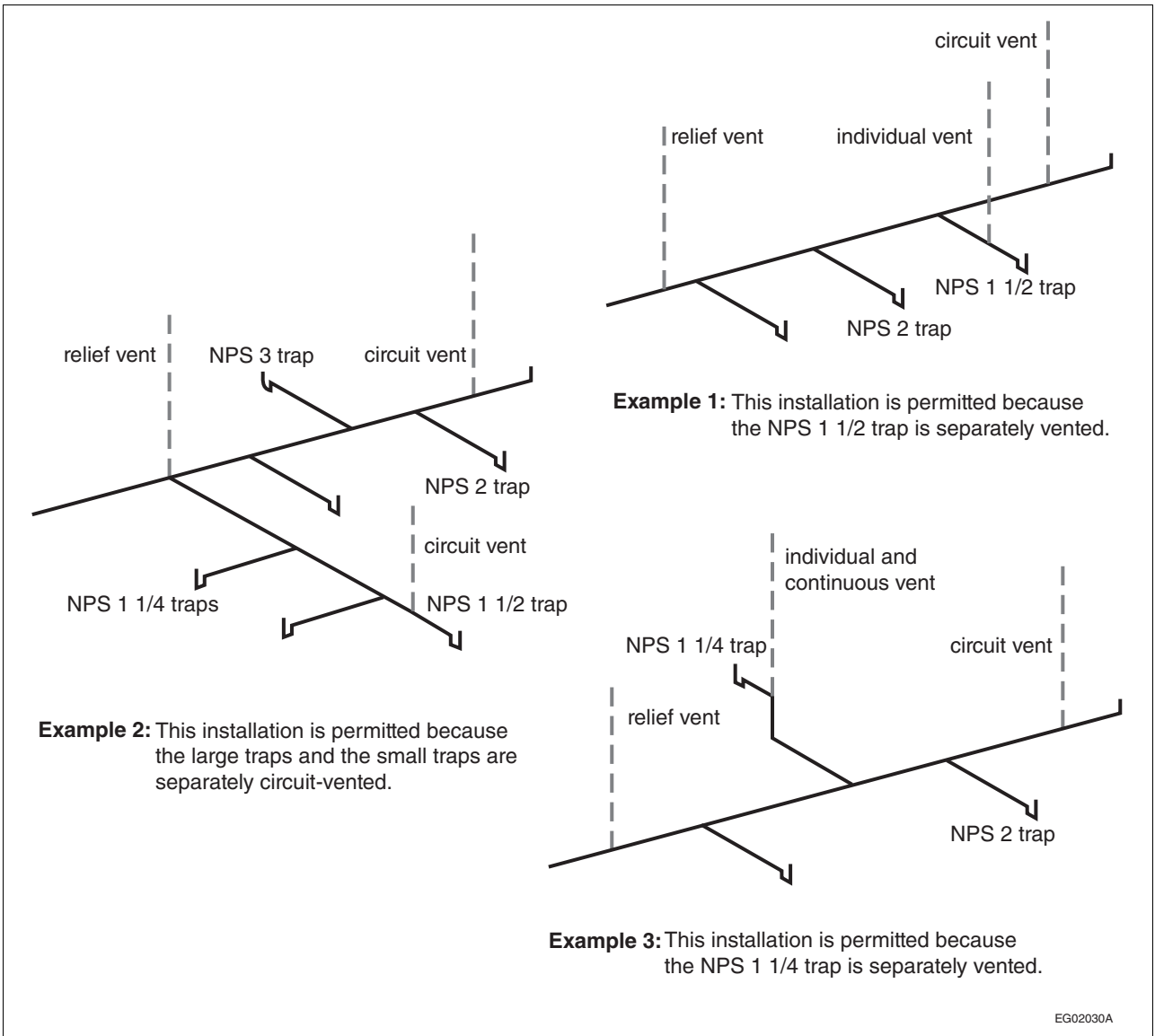
The information and figures presented in this Note are examples of the most common installation practices that meet NPC requirements. However, the examples shown do not preclude other installations that would also conform to NPC requirements.



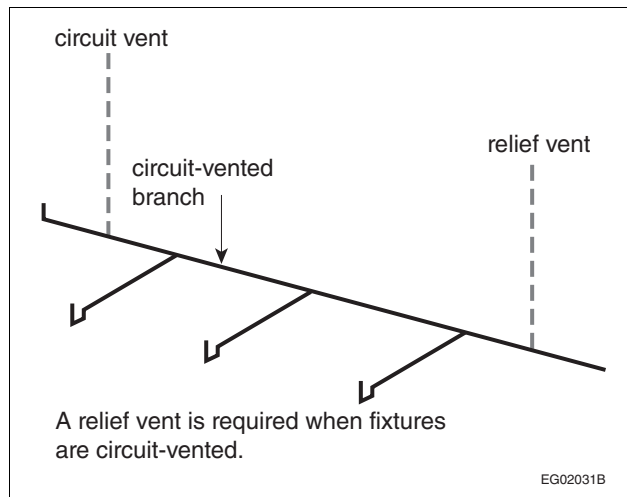
**Figure A-2.5.3.1.-A**  
**Example of circuit venting described in Sentence 2.5.3.1.(1)**



**Figure A-2.5.3.1.-B**  
**Example of circuit venting described in Clause 2.5.3.1.(1)(c)**

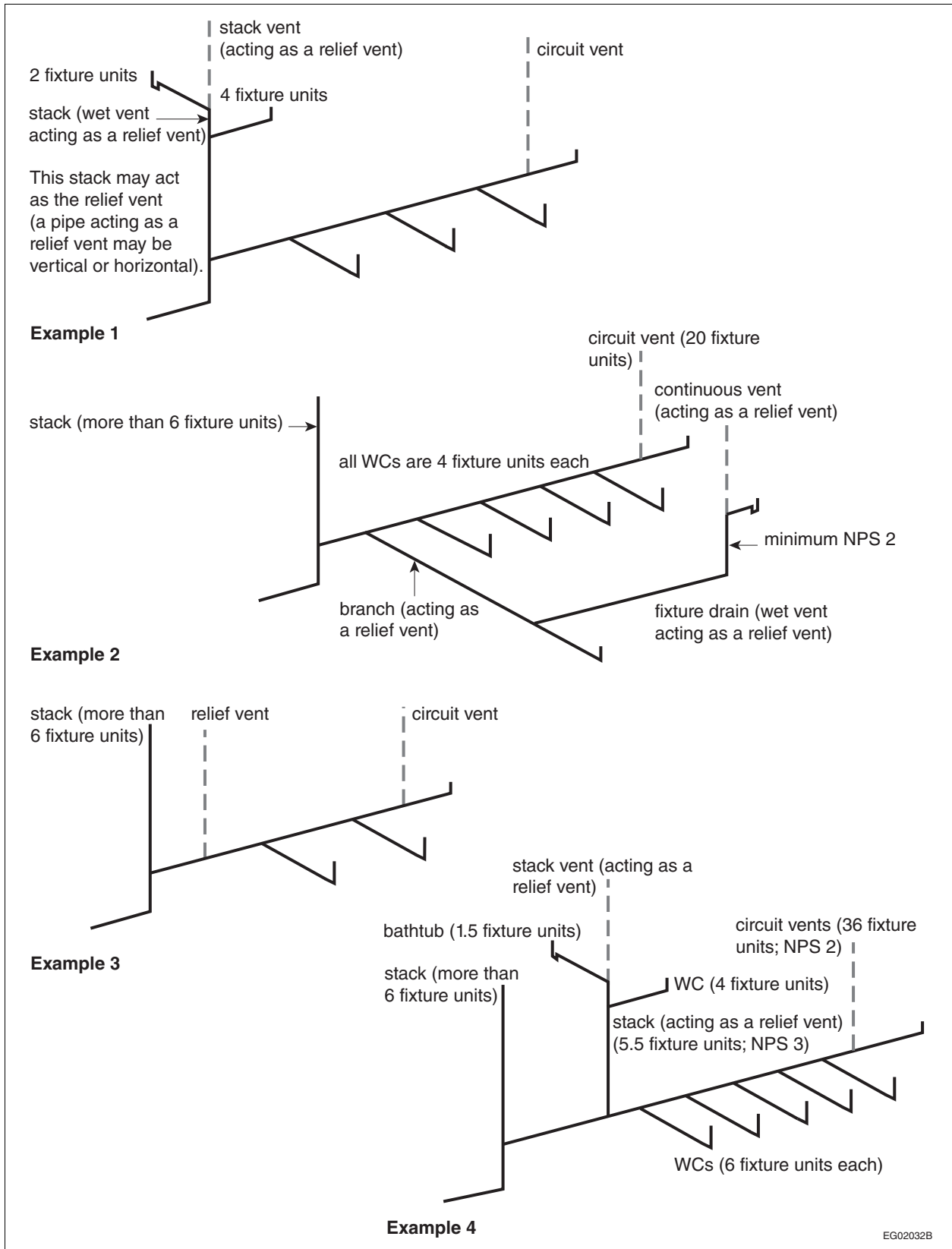


**Figure A-2.5.3.1.-C**  
 Example of circuit venting described in Sentence 2.5.3.1.(2), which refers to the nominal pipe size of fixture outlets



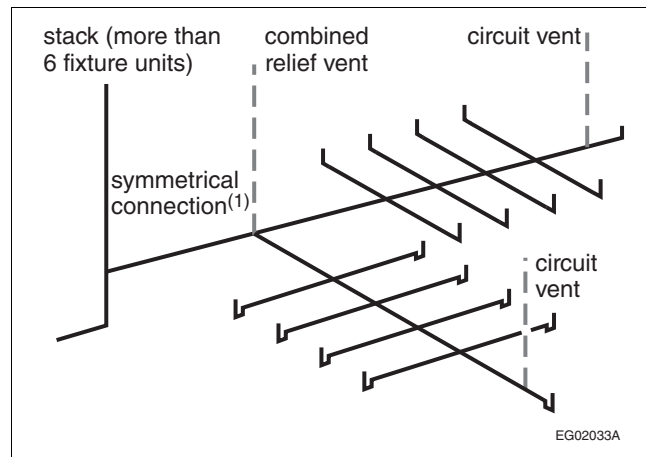
**Figure A-2.5.3.1.-D**  
 Example of circuit venting described in Sentence 2.5.3.1.(3)





**Figure A-2.5.3.1.-E**  
**Example of circuit venting described in Sentence 2.5.3.1.(4)**

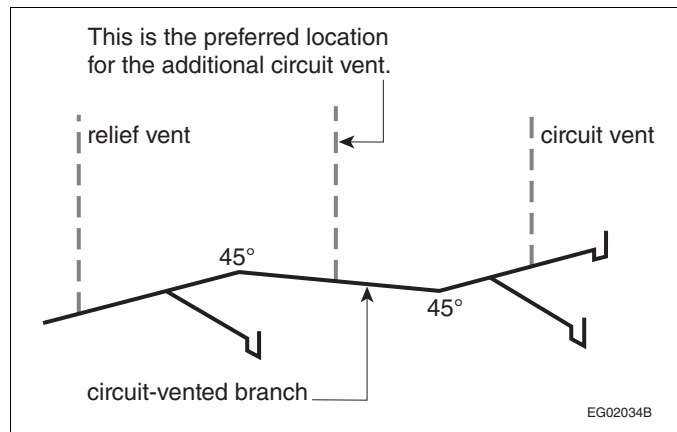
© His Majesty the King in Right of Canada, as represented by the National Research Council of Canada, 2025 © Sa Majesté le Roi du chef du Canada, représenté par le Conseil national de recherches du Canada, 2025



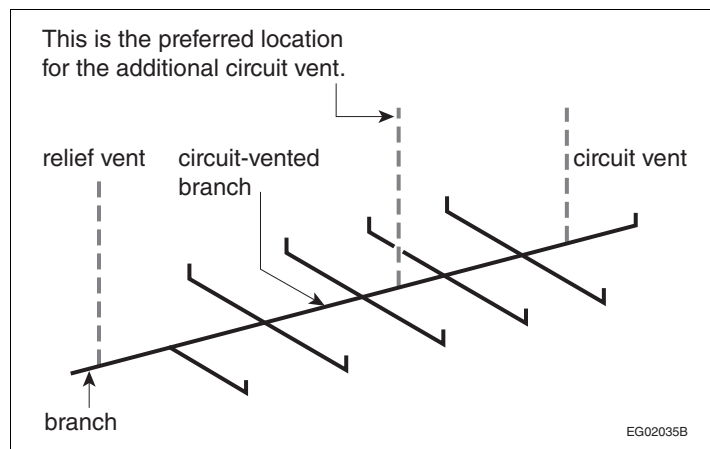
**Figure A-2.5.3.1-F**  
**Example of circuit venting described in Sentence 2.5.3.1.(5)**

**Note to Figure A-2.5.3.1-F:**

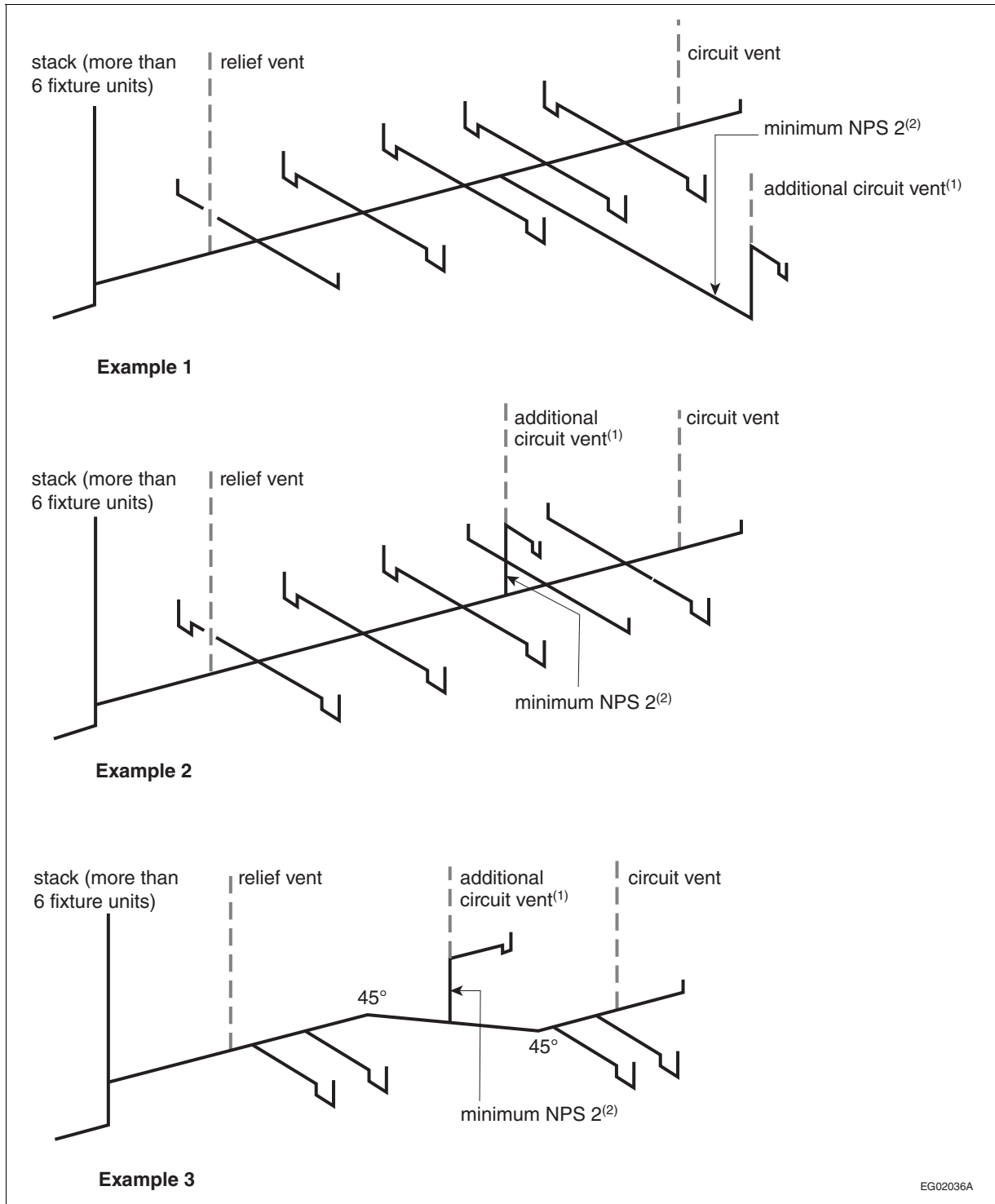
- (1) A symmetrical connection is accomplished with a manufactured fitting that has two or more inlets and connects two or more waste lines to a vent or wet vent.



**Figure A-2.5.3.1-G**  
**Example of circuit venting described in Clause 2.5.3.1.(6)(a)**



**Figure A-2.5.3.1-H**  
**Example of circuit venting described in Clause 2.5.3.1.(6)(b)**

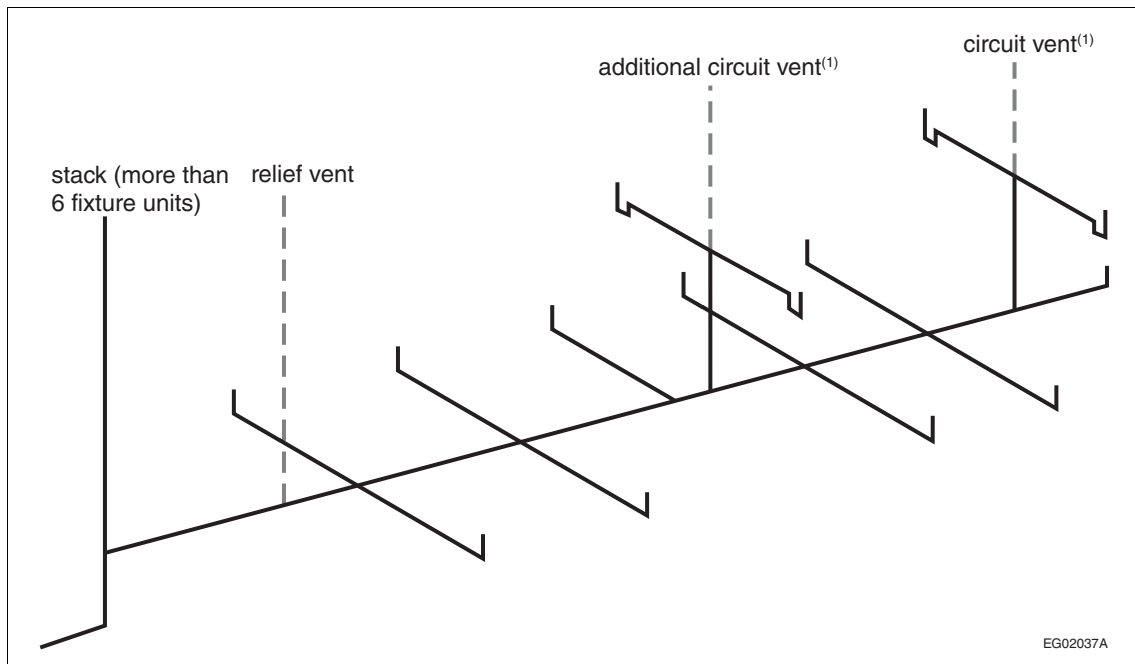


**Figure A-2.5.3.1.-I**  
**Example of circuit venting described in Sentence 2.5.3.1.(7)**

**Notes to Figure A-2.5.3.1.-I:**

- (1) Nominal pipe size as per Article 2.5.7.1. and Sentence 2.5.7.3.(1).
- (2) See Sentence 2.5.3.1.(7).

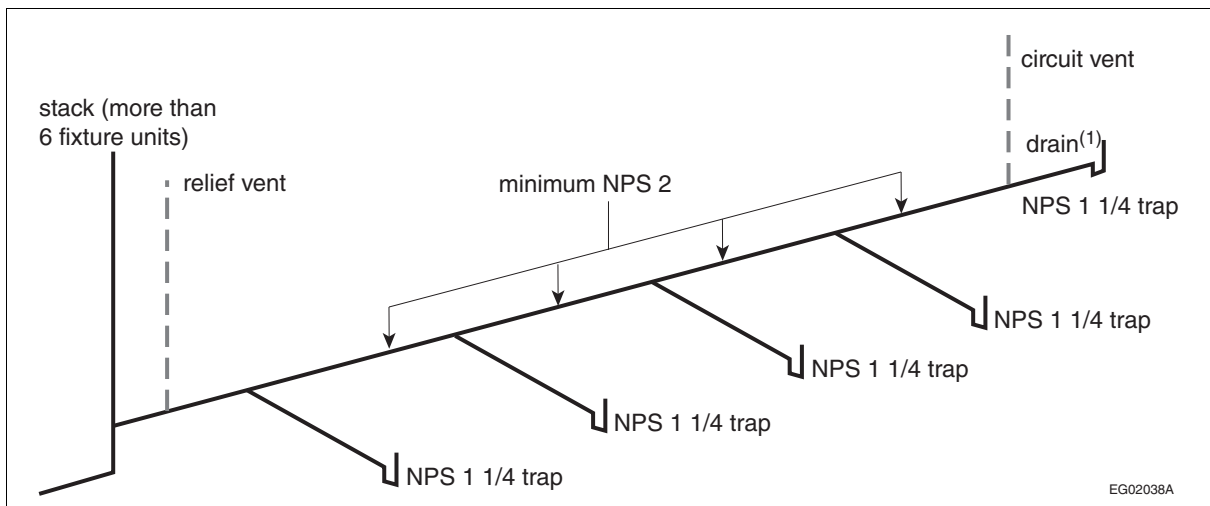
EG02036A



**Figure A-2.5.3.1-J**  
**Example of circuit venting described in Sentence 2.5.3.1.(8)**

**Note to Figure A-2.5.3.1.-J:**

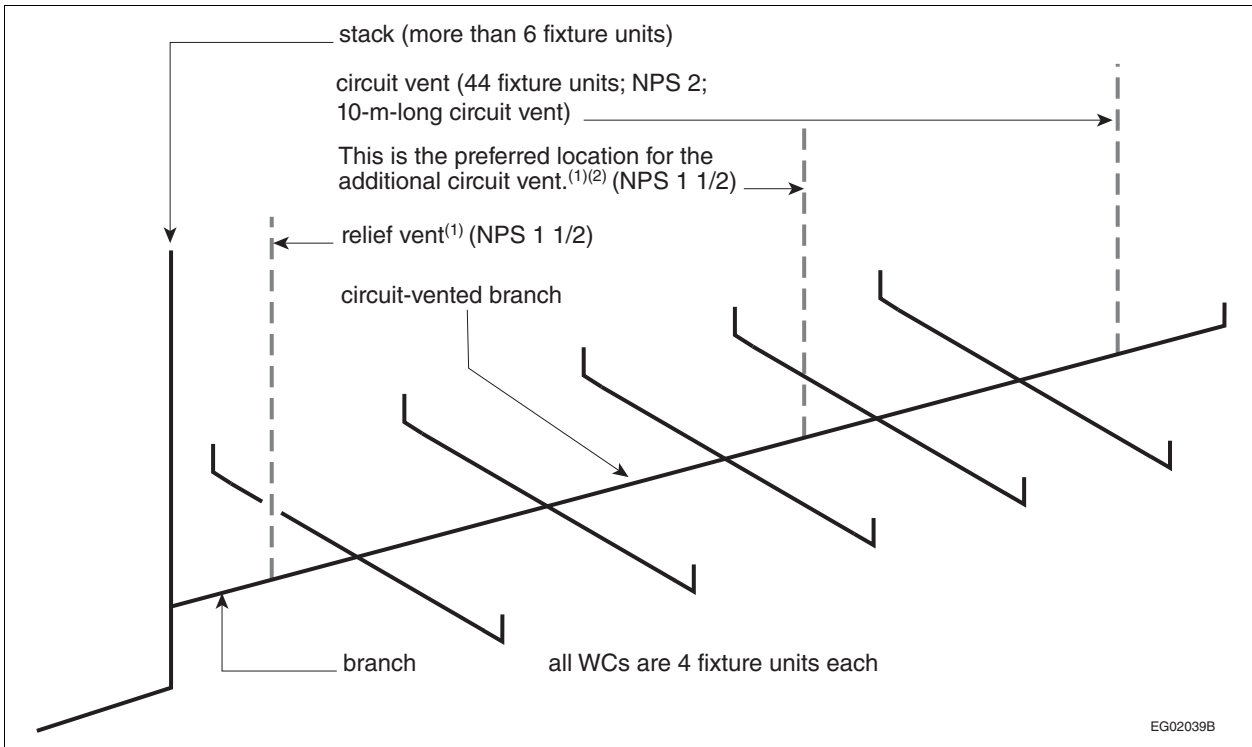
- (1) Connections to circuit vents and to additional circuit vents in accordance with Sentence 2.5.3.1.(6) shall conform to Sentence 2.5.4.5.(1), which states that a maximum of 2 fixtures (1.5 fixture units each) shall be connected to the vertical section by means of a double sanitary T.



**Figure A-2.5.3.1-K**  
**Example of circuit venting described in Sentence 2.5.3.1.(9)**

**Note to Figure A-2.5.3.1.-K:**

- (1) The drain is sized as a branch. The nominal pipe size of the drain should be increased as the load increases.

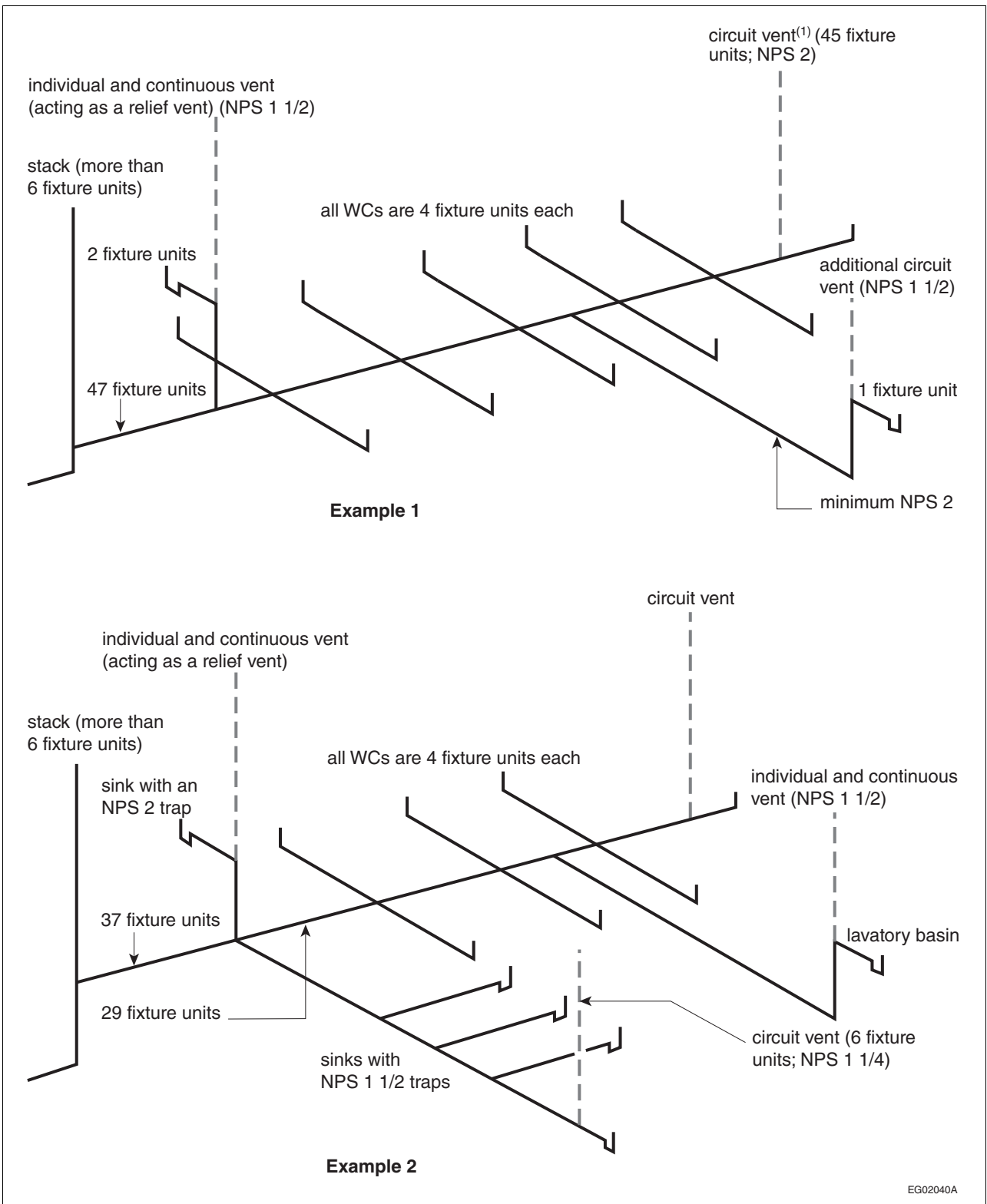


**Figure A-2.5.3.1.-L**

**Example of circuit venting described in Sentence 2.5.3.1.(10)**

**Notes to Figure A-2.5.3.1.-L:**

- (1) The relief vent and the additional circuit vent are one NPS smaller than the circuit vent.
- (2) See Sentence 2.5.7.3.(1).

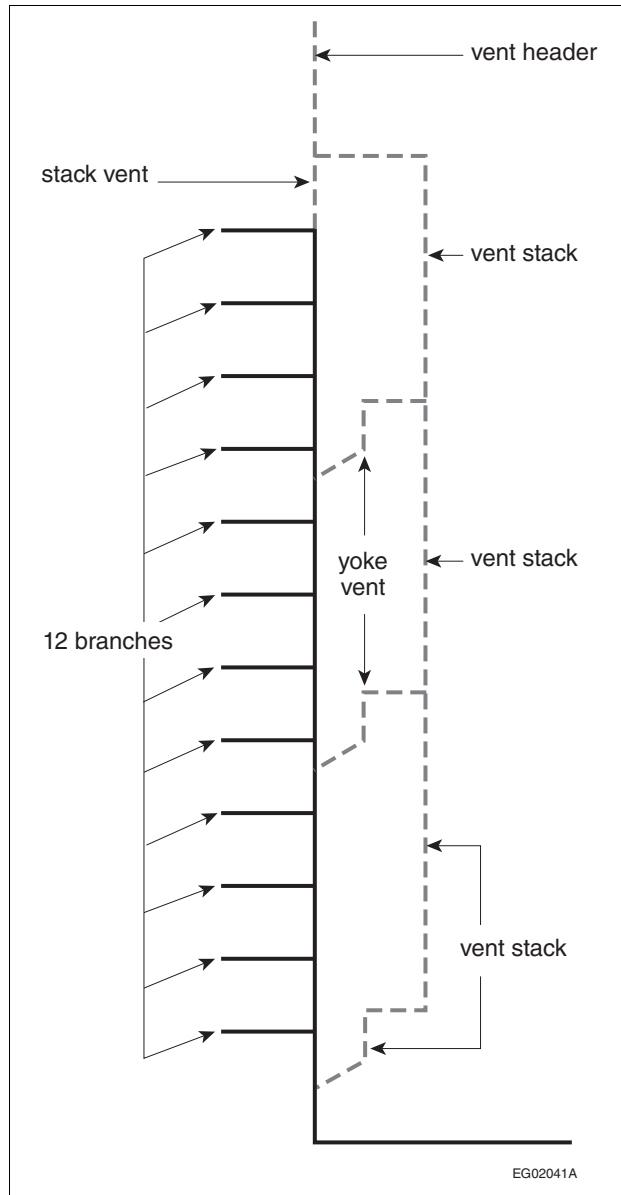


**Figure A-2.5.3.1.-M**  
**Example of circuit venting described in Sentence 2.5.3.1.(11)**

**Note to Figure A-2.5.3.1.-M:**

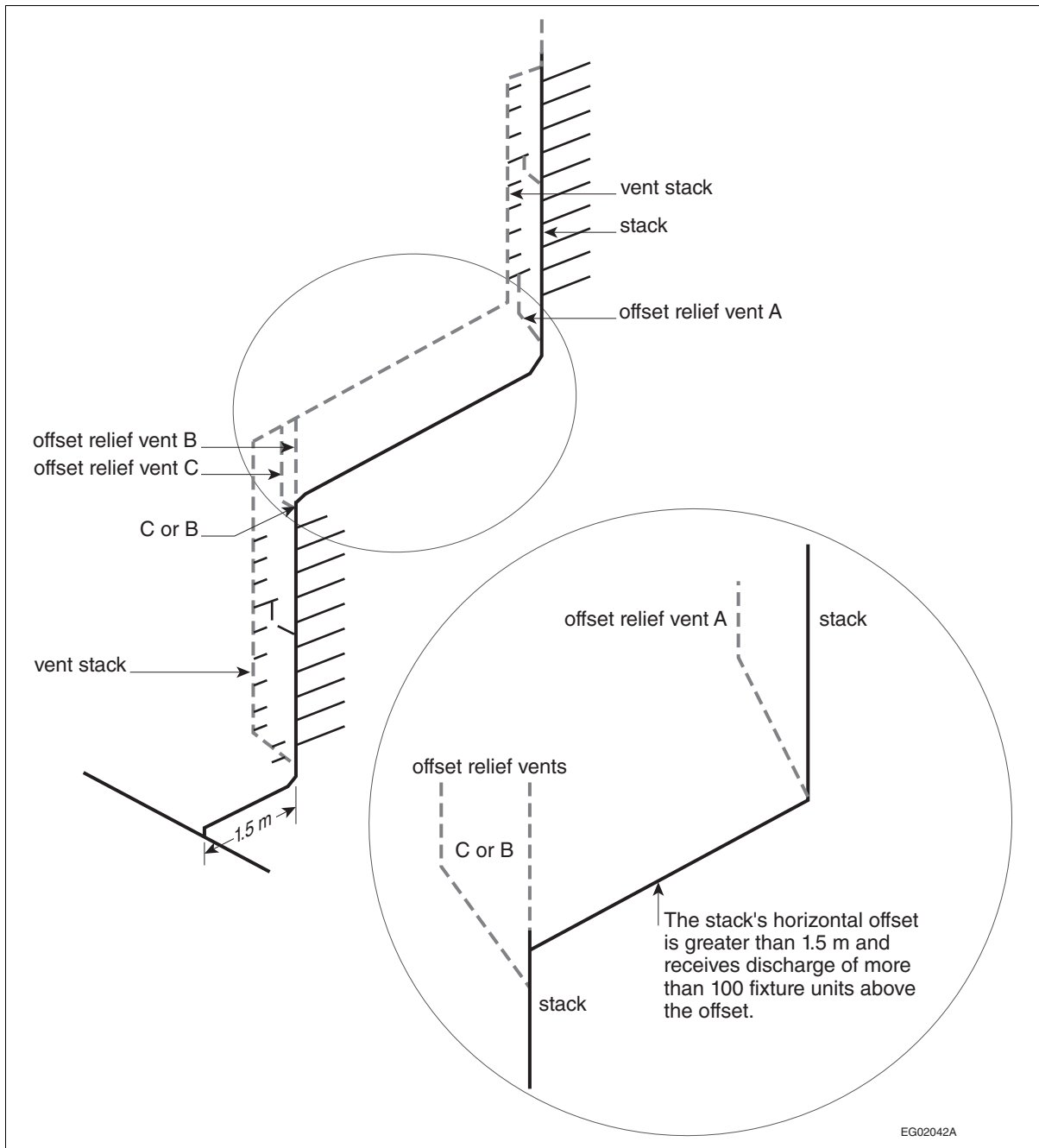
- (1) When sizing the circuit vent, do not include fixtures with a hydraulic load of 2 fixture units that are connected downstream of the most downstream water closets.

**A-2.5.4.3. Yoke Vent.** In Ontario, yoke vents have traditionally been referred to as modified stack vents.



**Figure A-2.5.4.3.**  
**Yoke vent**

**A-2.5.4.4.(1) Offset Relief Vents.** When an offset is greater than 1.5 m, it must be sized the same way as a branch or building drain (see Sentence 2.4.10.6.(2)). An offset relief vent is required at points A and B or A and C in Figure A-2.5.4.4.(1).

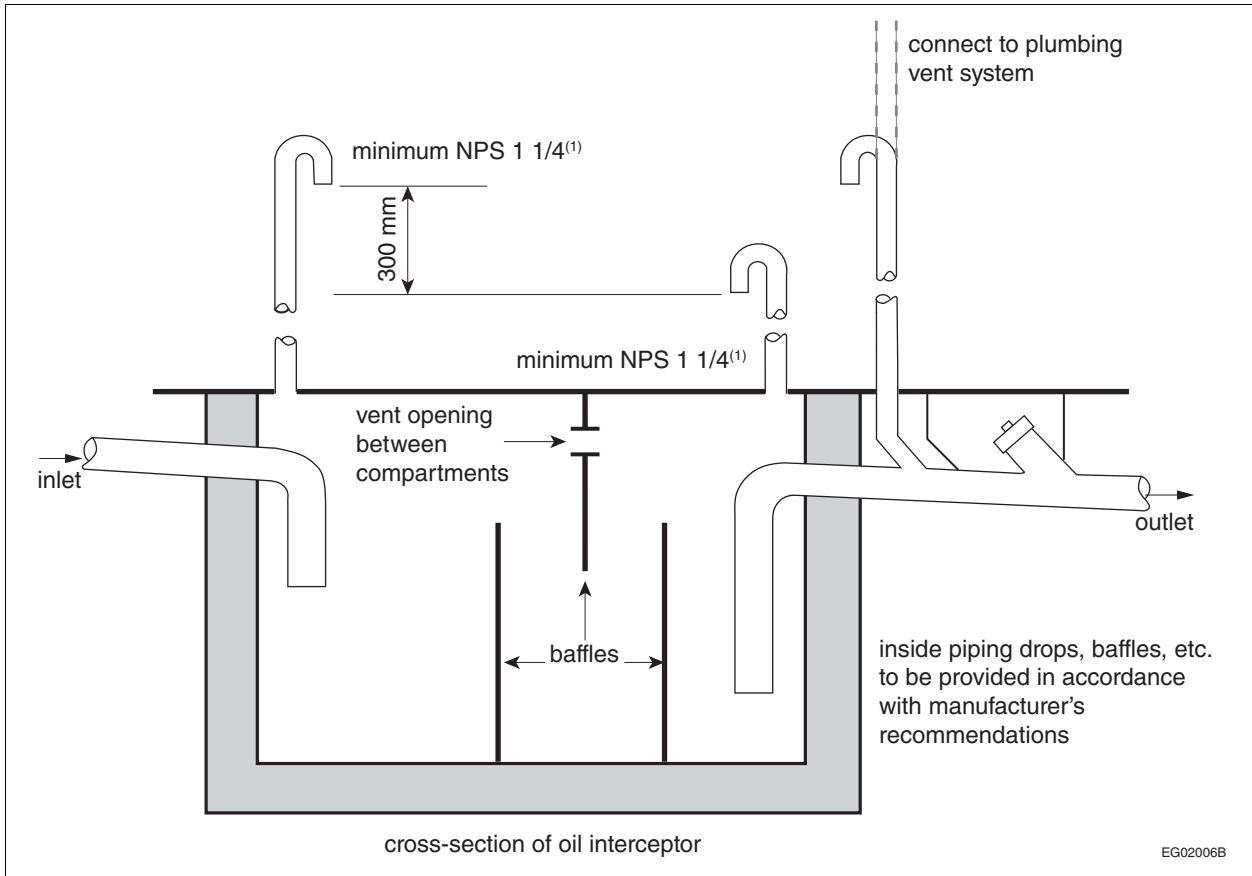


**Figure A-2.5.4.4.(1)**  
**Offset relief vents**

**A-2.5.4.5.(1) Fixture Connections to Vent Pipes.** When one or more fixture drains are connected to a vent pipe, the vent pipe becomes a wet vent. It must then conform to all the requirements that can apply to it as a drainage pipe and a vent pipe.



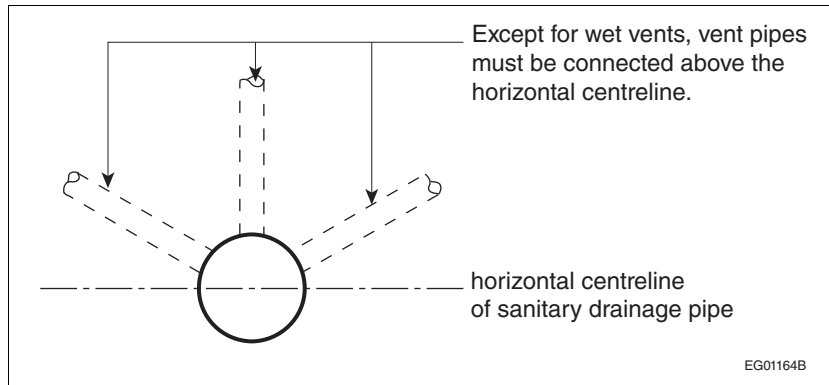
**A-2.5.5.2. Venting of Oil Interceptors.**



**Figure A-2.5.5.2.**  
**Venting of oil interceptors**

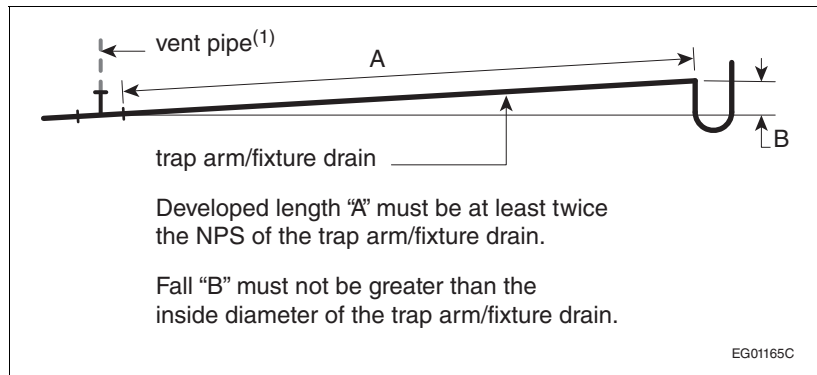
**Note to Figure A-2.5.5.2.:**  
(1) See Sentence 2.5.5.2.(4).

**A-2.5.6.2.(2) Vent Pipe Connections.** Fittings used to connect vent pipes to nominally horizontal sanitary drainage pipes are specified in Subsection 2.2.4.



**Figure A-2.5.6.2.(2)**  
**Vent pipe connections**

**A-2.5.6.3.(1) Vent Connection and Location of Vent Pipes.**

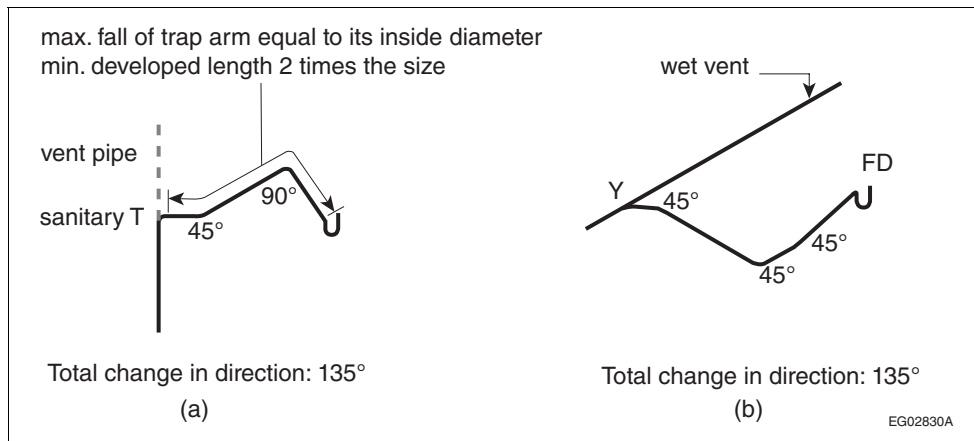


**Figure A-2.5.6.3.(1)-A**

**Vent connection**

**Note to Figure A-2.5.6.3.(1)-A:**

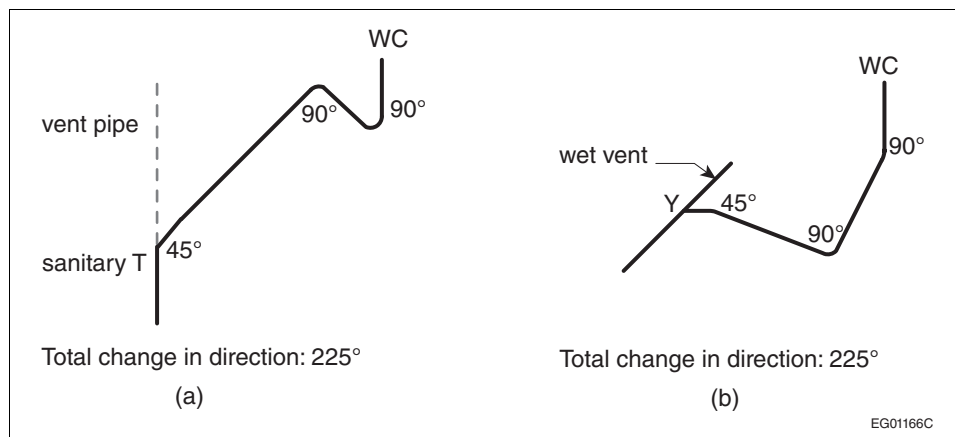
(1) The vent pipe must be connected in accordance with Article 2.5.6.2.



**Figure A-2.5.6.3.(1)-B**

**Location of vent pipes that protect fixture traps and maximum change in direction of trap arms**

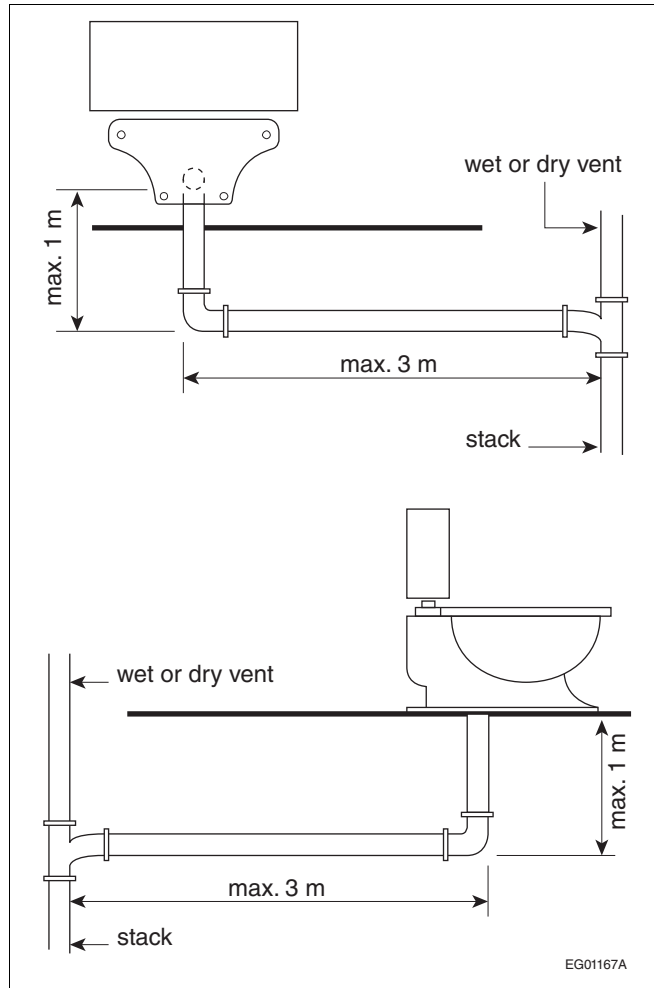
**A-2.5.6.3.(2) Location of Vent Pipes.**



**Figure A-2.5.6.3.(2)**

**Location of vent pipes and maximum change in direction of trap arms for fixtures that depend on siphonic action**

**A-2.5.6.3.(3) Length of Water-Closet Fixture Drain.**



**Figure A-2.5.6.3.(3)**  
**Length of water-closet fixture drain**

**Note to Figure A-2.5.6.3.(3):**

- (1) Fall and length of water-closet fixture drain applies to floor-mounted and wall-hung water closets.

© His Majesty the King in Right of Canada, as represented by the National Research Council of Canada, 2025 © Sa Majesté le Roi du chef du Canada, représenté par le Conseil national de recherches du Canada, 2025

**A-2.5.6.5.(4) Vent Terminals.** No vent pipe other than a fresh air inlet may terminate within the limits indicated.

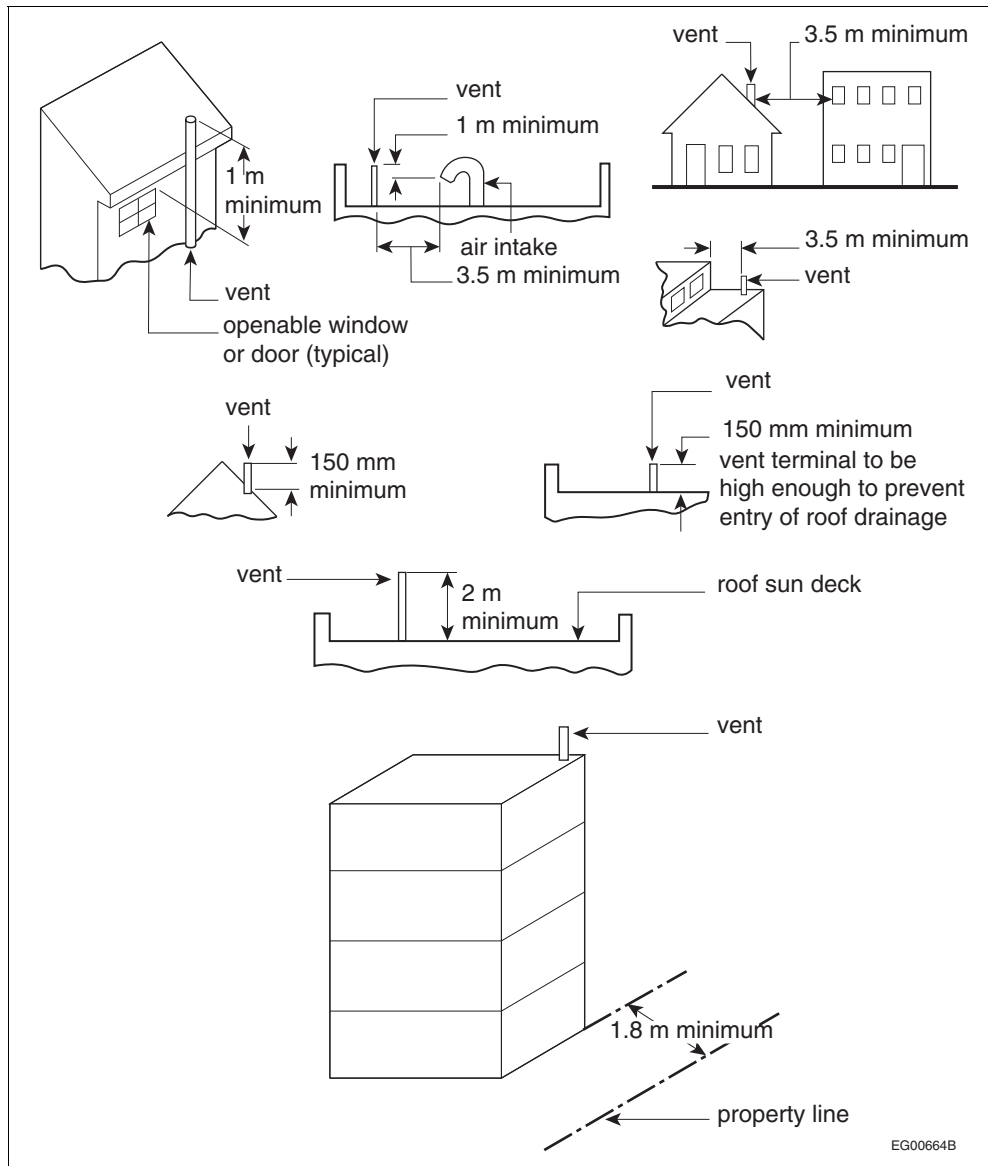
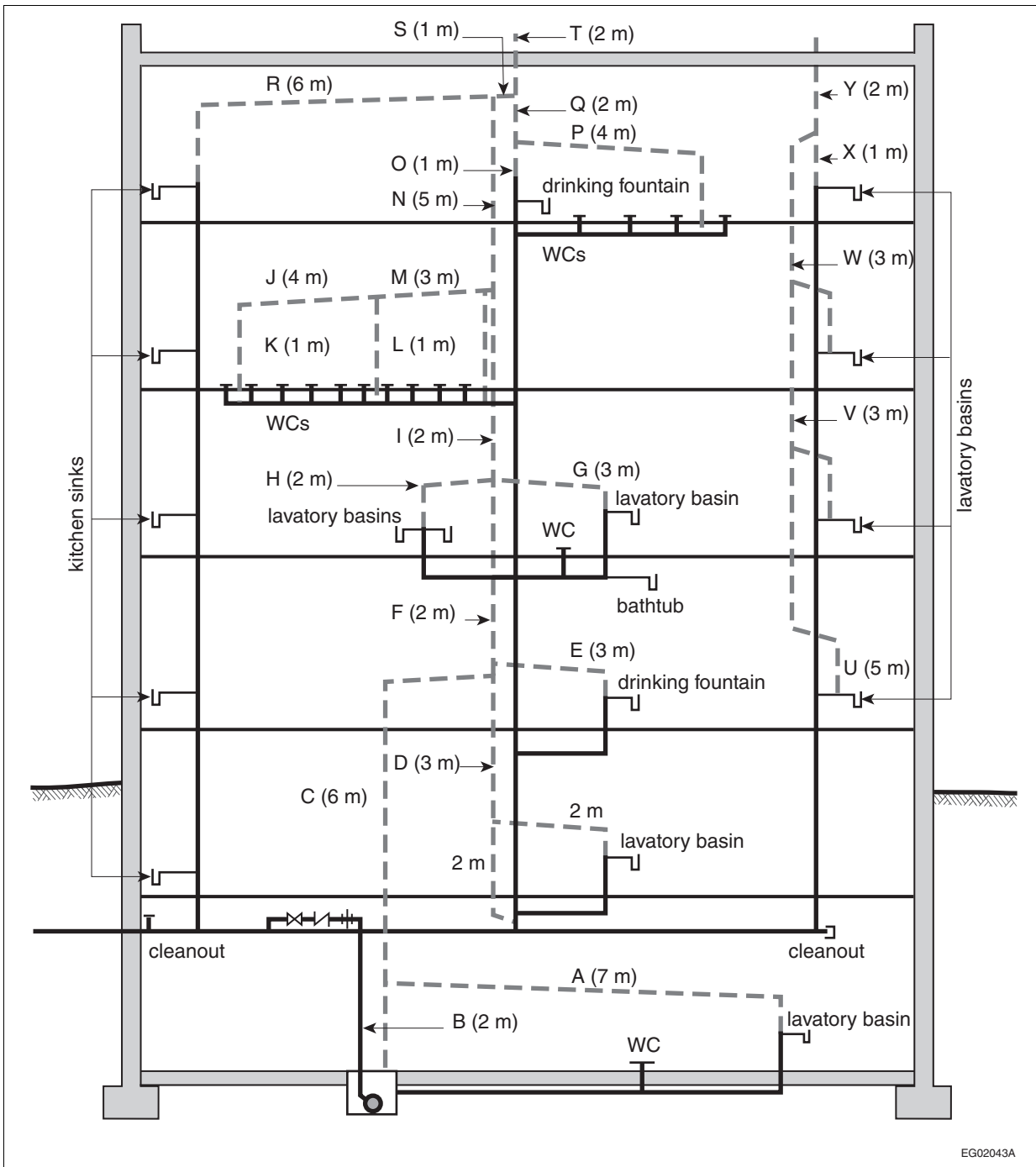


Figure A-2.5.6.5.(4)  
Vent terminals

EG00664B

**A-2.5.8. Sizing of Venting Systems.** Vent pipes are connected to the drainage system and terminate outside the building. They allow air to enter and circulate and they protect the trap seals in the drainage system. Except as permitted in Subsection 2.5.1., a trap shall always be protected by a vent pipe.



**Figure A-2.5.8.**  
Sizing of a venting system

**Notes to Figure A-2.5.8.:**

- (1) All water closets are 4 fixture units each.
- (2) The letters in columns 1 and 3 of Table A-2.5.8. correspond to the letters in this Figure.

**Sizing of Vent Pipes**

The nominal pipe sizes stated in Table 2.5.7.1. take precedence over all other venting tables.

**Sizing of Relief Vents**

Length is not taken into consideration when sizing a relief vent and an additional circuit vent. A relief vent connected to a circuit-vented branch is sized according to Sentences 2.5.7.3.(1) and (2).

An offset relief vent is sized according to Sentence 2.5.7.4.(1), which permits the offset relief vent to be one NPS smaller than the stack vent.

**Table A-2.5.8.**  
**Sizing of Venting Systems**

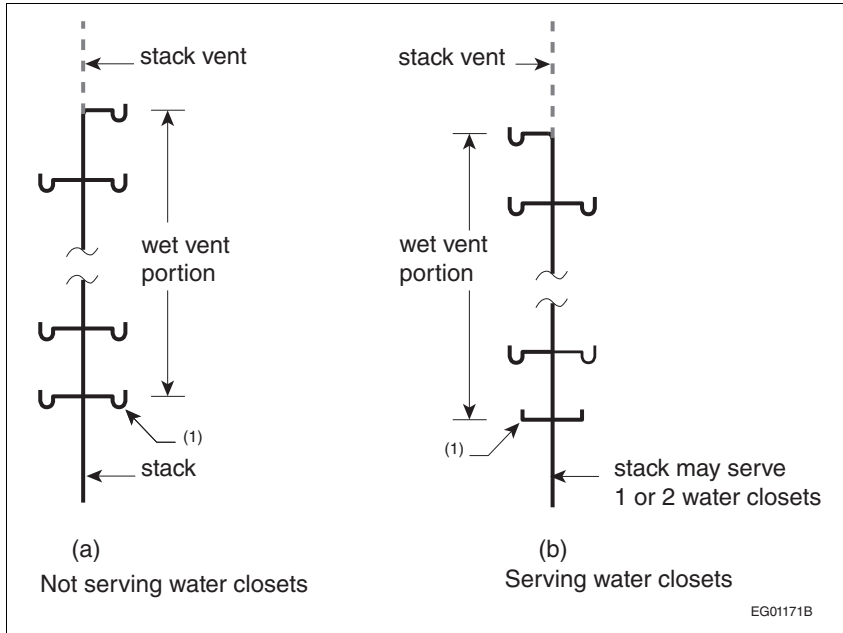
Vent Pipe <sup>(1)</sup>	Vent Name	Developed Length Used to Determine Nominal Pipe Size, m <sup>(1)</sup>	Hydraulic Load Used to Determine Nominal Pipe Size, fixture units	Code Reference	Minimum Nominal Pipe Size
A	Continuous vent	A + C = 13	5	2.5.7.1.	1½
B	Sump vent	n/a	n/a	2.5.7.7.(1)	2
C	Branch vent	A + C = 13	5	2.5.7.7.(2)	2
D	Vent stack	2 + D + F + I + N + S + T = 17	66	2.5.7.1. 2.5.7.2.	3
E	Individual and continuous vent	n/a	n/a	2.5.7.1.	1¼
F	Vent stack	Same as D = 17	71	Same as D	3
G	Continuous vent	G = 3	6	2.5.8.3.(5) 2.5.7.1.	1½
H	Dual and continuous vent	n/a	n/a	2.5.7.1.	1¼
I	Vent stack	Same as D = 17	71	Same as D	3
J	Circuit vent	J + M = 7	40	2.5.7.1. 2.5.8.3.(4)	1½
K	Additional circuit vent	n/a	n/a	2.5.7.1. 2.5.7.3.(1)	1½
L	Relief vent	n/a	n/a	2.5.7.1. 2.5.7.3.(1)	1½
M	Branch vent	J + M = 7	40	2.5.7.1. 2.5.7.2.	1½
N	Vent stack	Same as D = 17	71	Same as D	3
O	Stack vent	O + Q + T = 5	66	2.5.7.1. 2.5.8.4.	2
P	Circuit vent	P = 4	16	2.5.7.1. 2.5.8.3.(4)	1½
Q	Stack vent	Same as O = 5	66	2.5.7.1. 2.5.8.4.	2
R	Stack vent	R + S + T = 9	7.5	2.5.2.1.(1)(a)	3
S	Vent header	A + C + F + I + N + S + T = 25	78.5	2.5.8.3.(3)	3
T	Vent header	Same as S = 25	78.5	2.5.8.3.(3)	3
U	Individual vent	n/a	n/a	2.5.7.1.	1¼
V	Branch vent	U + V + W = 11	2	2.5.7.1. 2.5.7.2.	1¼
W	Branch vent	Same as V = 11	3	2.5.7.1. 2.5.7.2.	1¼
X	Stack vent	X + Y = 3	4	2.5.7.1. 2.5.8.4.	1¼
Y	Stack vent	Same as X = 3	4	2.5.7.1. 2.5.8.4.	1¼

**Table A-2.5.8. (Continued)**

**Notes to Table A-2.5.8.:**

(1) The letters in columns 1 and 3 correspond to the letters in Figure A-2.5.8.

**A-2.5.8.1.(2) Sizing of Wet Vent Systems.**

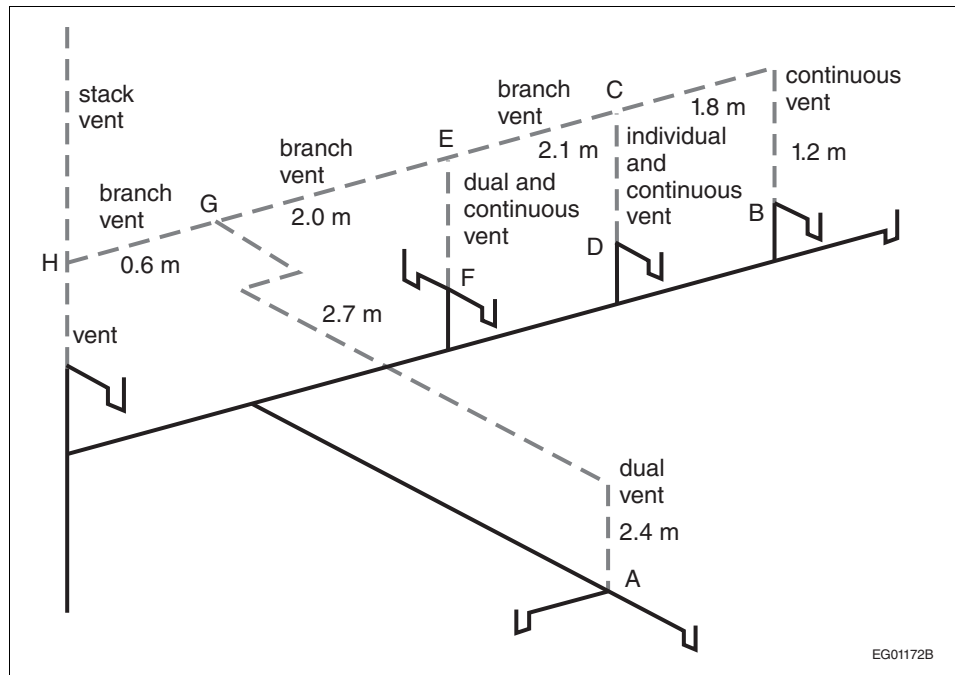


**Figure A-2.5.8.1.(2)**  
**Sizing of wet vent systems**

**Note to Figure A-2.5.8.1.(2):**

(1) These two fixtures are not included when determining the nominal pipe size of the wet vent portion using Table 2.5.8.1.

**A-2.5.8.3. and 2.5.8.4. Lengths to be Considered When Sizing Vent Pipes.**

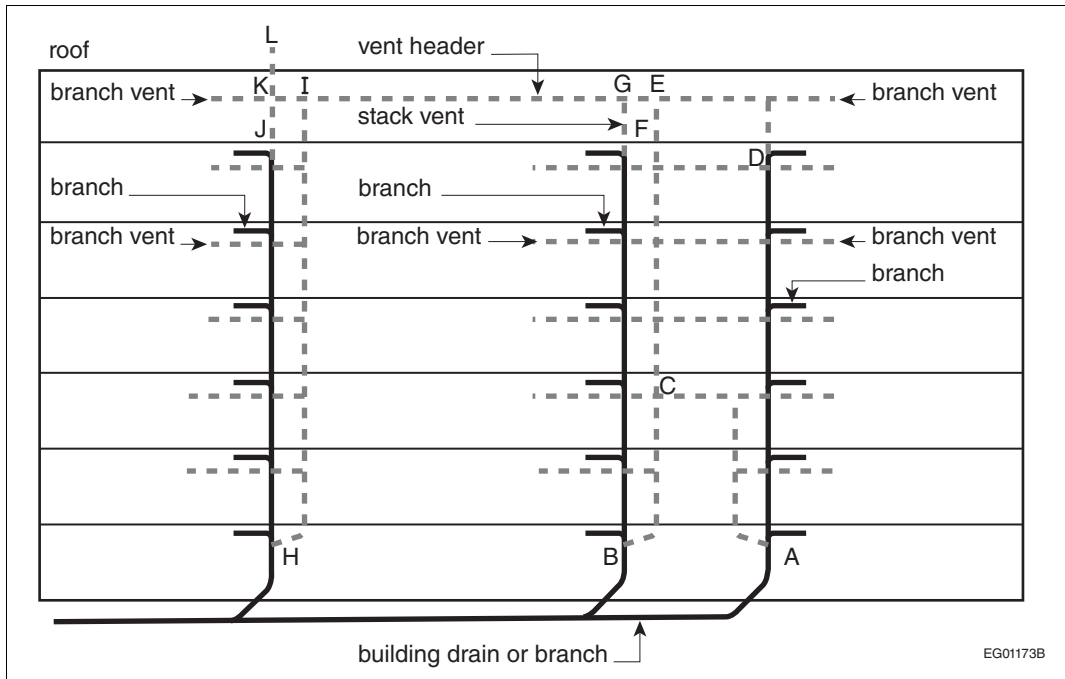


**Figure A-2.5.8.3. and 2.5.8.4.-A**  
**Lengths to be considered when sizing branch, continuous, dual and individual vent pipes**

**Notes to Figure A-2.5.8.3. and 2.5.8.4.-A:**

- (1) The length of the vent pipe does not apply when sizing vent pipes A-G, D-C and F-E. See Article 2.5.8.2.
- (2) The vent pipe length to be considered when sizing vent pipes B-C, C-E, E-G and G-H is based on the length of BCEGH (i.e., 1.2 + 1.8 + 2.1 + 2.0 + 0.6 = 7.7 m). See Article 2.5.8.3.





**Figure A-2.5.8.3. and 2.5.8.4.-B**  
**Lengths to be considered when sizing stack vent, vent stack and vent header pipes**

**Notes to Figure A-2.5.8.3. and 2.5.8.4.-B:**

- (1) The vent pipe lengths to be considered when sizing the vent stacks and stack vents are as follows:
  - vent stack A-C: ACEGIKL
  - vent stack B-C: BCEGIKL
  - vent stack H-I: HIKL
  - stack vent D-E: DEGIKL
  - stack vent F-G: FGIKL
  - stack vent J-K: JKL
 See Sentence 2.5.8.4.(2).
- (2) The vent pipe length to be considered when sizing the vent header pipe CEGIKL, or any section of it, is the length of ACEGIKL. See Sentence 2.5.8.3.(3).

**A-2.6.1.3.(5) Shut-off Valves.** Where multiple risers convey the water supply to dwelling units, each dwelling unit's water distribution system shall be provided with a shut-off valve located immediately where the water piping enters the suite so as to isolate the fixtures as well as the water distribution piping serving the dwelling unit's fixtures. Fixture stopcocks or shut-off valves located immediately adjacent to a fixture may not be adequate to protect the water distribution piping. Where a dwelling unit is served by a single shut-off valve on the water supply, additional shut-off valves may be required to achieve compliance with Sentences 2.6.1.3.(4) and (7).

**A-2.6.1.6.(5) Flush-Tank-Type Urinals in Seasonal Buildings.** Flush-tank-type urinals that are not in use for an extended period of time, such as those in seasonal buildings, are permitted to be set up to flush automatically at predetermined intervals. Automatic flushing prevents the depletion of the water seal due to evaporation or backflow conditions. The trap seal restricts the infiltration of gases, which can pose health and safety concerns.

**A-2.6.1.7.(5) Relief Valves.** If the discharge piping is longer than 2 m or more than two 90° elbows are used, the valve manufacturer's installation instructions should be followed to ensure that the piping does not affect the relief valves' discharge capacity.

**A-2.6.1.9.(1) Water Hammer Prevention.** Water hammer is a buildup of pressure in a length of horizontal or vertical pipe that occurs when a valve or faucet is closed suddenly. The longer the pipe and the greater the water velocity, the greater the pressure exerted on the pipe, which can be many times the normal static water pressure and be sufficient to damage the piping system. Since air chambers made from a piece of vertical pipe do not provide acceptable protection, pre-manufactured water hammer arresters are required to address this potential problem. Water hammer arresters need not be installed at every valve or faucet, nor in every piping system.

**A-2.6.1.11.(1) Thermal Expansion.** To accommodate the increase in pressure caused by thermal expansion within a closed water distribution system, one of the following should be installed:

- (1) a suitably sized diaphragm expansion tank designed for use within a potable water system,
- (2) an auxiliary thermal expansion relief valve (T.E.R. valve) conforming to CSA B125.3, “Plumbing fittings,” set at a pressure of 550 kPa or less and designed for repeated use, or
- (3) other means acceptable to the authority having jurisdiction.

**A-2.6.1.12.(1) Service Water Heaters.** Storing hot water at temperatures below 60°C in the hot water tank or in the delivery system may lead to the growth of legionella bacteria. Contemporary electric water heater tanks experience temperature stratification and thus tend to have legionella bacteria in the lower parts of the tank. Article 2.6.1.12. specifies a thermostat setting of 60°C, which addresses the concern over the growth of legionella bacteria in electric hot water storage tanks and is enforceable without introducing unnecessary complications. The growth of legionella bacteria is not a concern for other types of water heaters with different designs that use different fuels.

Electrically heated water heaters are shipped with the thermostat set at 60°C. Article 2.6.1.12. is included in the NPC to formalize this de facto temperature setting as a requirement. The thermostats have graduated temperature markings to allow such a setting, which is not the case with gas- or oil-heated water heaters.

**A-2.6.2.4.(2) Backflow from Fire Protection Systems.** The following document is considered to be good engineering practice when selecting a backflow preventer for installation on a fire protection system: AWWA M14, “Recommended Practice for Backflow Prevention and Cross-Connection Control.”

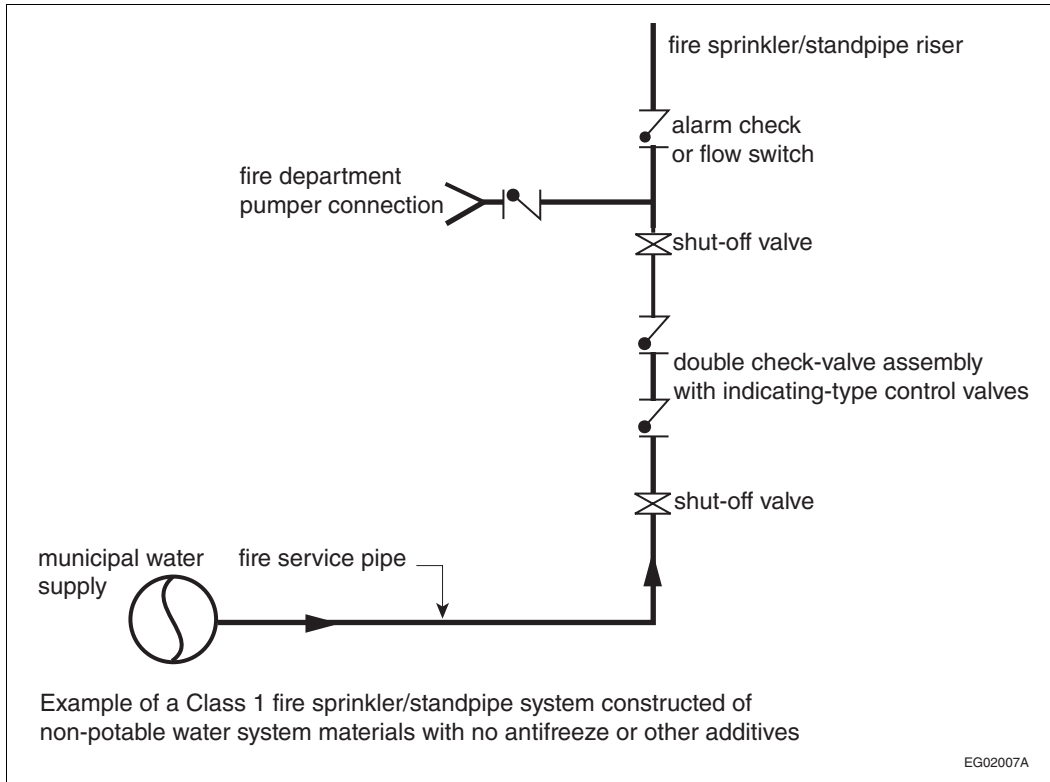
**Table A-2.6.2.4.(2)**  
**Selection Guide for Backflow Prevention Devices on Fire Sprinkler and Standpipe Systems**

CSA Standard Number	Type of Device <sup>(1)</sup>	Systems Made with Potable Water System Materials <sup>(2)</sup>		Systems Not Made with Potable Water System Materials <sup>(2)</sup>	
		Minor Hazard — Residential Partial Flow-Through System	Minor Hazard — Class 1 System	Moderate Hazard — Class 1, 2, 3 and 6 Systems	Severe Hazard — Any Class of System in which Antifreeze or Other Additives Are Used
CSA B64.6.1	DuCF	P	NP	NP	NP
CSA B64.9	SCVAF	P	P	NP	NP
CSA B64.5.1	DCVAF	P	P	P	NP
CSA B64.4.1	RPF	P	P	P	P

**Notes to Table A-2.6.2.4.(2):**

- (1) The “F” indicates that the product is only recommended for use on fire sprinkler and standpipe systems.
- (2) NP = not permitted and P = permitted.

**A-2.6.2.4.(3) Fire Department Pumper Connection and Backflow Protection.**



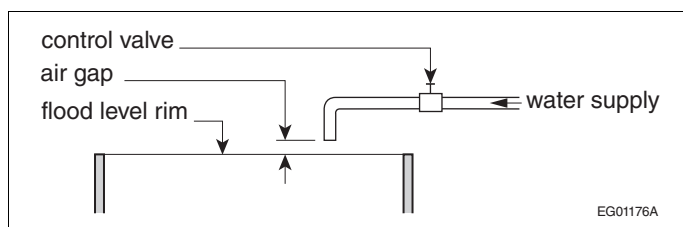
**Figure A-2.6.2.4.(3)**  
**Fire department pumper connection and backflow protection**

**A-2.6.2.6.(1) Locations Requiring Premise Isolation.** The following list is a guide to locations where premise isolation may be required:

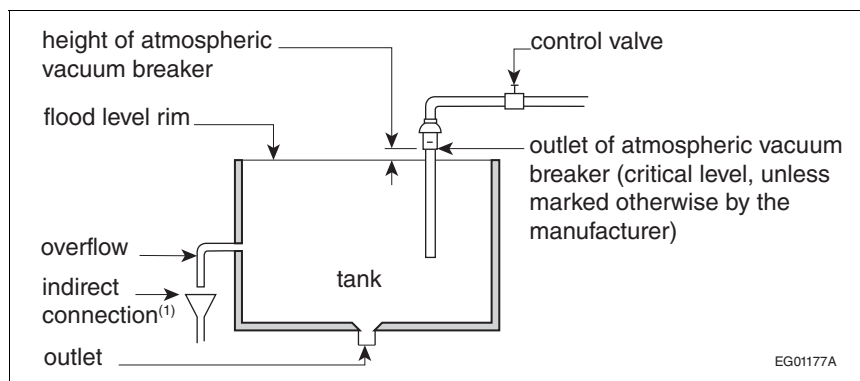
- hospital buildings with operating, mortuary or laboratory facilities
- radioactive material processing plants
- petroleum processing facilities
- premises where inspection is restricted
- sewage treatment plants
- commercial laundries (excluding laundromats)
- plating or chemical plants
- docks and dockside facilities
- food and beverage processing plants
- steam plants
- trackside facilities for trains

An assessment of the hazard must be carried out to determine the need, if any, for a backflow prevention device.

**A-2.6.2.9.(2) Installation of Air Gaps.**



**Figure A-2.6.2.9.(2)**  
**Installation of air gaps**

**A-2.6.2.10.(2) Installation of Atmospheric Vacuum Breakers.****Figure A-2.6.2.10.(2)****Installation of atmospheric vacuum breakers**

**Note to Figure A-2.6.2.10.(2):**

(1) See Sentence 2.3.3.11.(1).

**A-2.6.3. Water Systems.** Subsection 2.6.3. contains performance requirements for water systems. Two widely used references for the design of water systems are:

NIST Building Materials and Structures Report BMS 79, "Water-Distributing Systems for Buildings," United States Department of Commerce, National Bureau of Standards, Washington, D.C., and

McGraw-Hill 2009, "International Plumbing Codes Handbook," edited by V.T. Manas, McGraw-Hill Book Company, New York, U.S.A.

**A-2.6.3.1. Water Quality.** Water destined for use as potable water can originate from a variety of sources that are generally classified as surface waters or well waters, such as lakes, rivers, streams and aquifers. In some localities, there may be seasonal variations in the water supply, and surface and well waters may be blended at times.

Water composition is the primary consideration in determining the cause of corrosion in potable water systems. If the water has corrosive characteristics, water treatment may be necessary to control its corrosiveness: this may be as straightforward as adjusting the pH of the water at the treatment plant, or it may involve more extensive corrosion-control methods. Water purveyors normally consult treatment specialists to develop methods suitable for specific conditions. The treatment of water from private wells may also require expert consultation.

The past performance of plumbing materials and products in different localities often provides insight into what can be expected with new installations. In areas where water-related corrosion is known to occur, adjustment of water chemistry may be sufficient or it may be necessary to select alternative piping and fitting materials or more robust products.

It is important to note that not all corrosion can be attributed to water conditions: the improper design and installation of potable water systems may result in erosion corrosion, galvanic corrosion, fatigue cracking, and so forth.

**A-2.6.3.1.(2) Potable Water Systems.** The design procedures contained in the following documents are considered good engineering practice in the field of potable water systems:

- ASHRAE 2011, "ASHRAE Handbook – HVAC Applications," chapter on Service Water Heating,
- ASHRAE 2013, "ASHRAE Handbook – Fundamentals," chapter on Pipe Sizing,
- ASPE 2010, "Plumbing Engineering Design Handbook, Volume 2," chapter on Cold Water Systems, and
- ASPE 2010, "Plumbing Engineering Design Handbook, Volume 2," chapter on Domestic Water Heating Systems.

Alternatively, the following methods, which apply to both public and private water supplies, may be used in determining the size of each section of the water system using Table A-2.6.3.1.(2)-A (Small Building Method) and Table A-2.6.3.1.(2)-F (Average Pressure Loss Method). Where these methods are considered an alternative

to a detailed engineering design method, the hydraulic loads shall be the sum of the total fixture units given in Tables 2.6.3.2.-A, 2.6.3.2.-B, 2.6.3.2.-C and 2.6.3.2.-D.

### Small Building Method

Information required if using this method:

- (a) The developed length:
  - (i) from the property line or private water supply system when located outside the building to the water service entry point to the building, and
  - (ii) from the water service entry point to the building to the most remote water outlet.
- (b) Minimum static pressure:
  - (i) the minimum static pressure available at the property line or other water source (private water supply system), or
  - (ii) where there is a wide fluctuation of pressure in the main throughout the day, the minimum static pressure available.
- (c) Pressure losses:
  - (i) losses for meters, pressure-reducing valves, backflow preventers, water treatment systems, and any other devices, and
  - (ii) losses or gains due to changes in elevation.
- (d) The number of fixture units (FU) as determined by using the sum of the total values given in Tables 2.6.3.2.-A, 2.6.3.2.-B, 2.6.3.2.-C and 2.6.3.2.-D.
- (e) The maximum velocities permitted in accordance with the manufacturer's recommendations for the pipe and fittings chosen for the installation.

Note that a private water supply system must be capable of meeting the demands of the water distribution system.

#### Pipe Sizing Procedures (see Figure A-2.6.3.1.(2)-A)

##### Step 1: Water Service Piping (see Table A-2.6.3.1.(2)-B)

- (a) Obtain the total fixture units required for the installation using the sum of the total values given in Tables 2.6.3.2.-A, 2.6.3.2.-B, 2.6.3.2.-C and 2.6.3.2.-D and consider all other demands on the water supply.
- (b) Determine the minimum static pressure available at the property line or private water supply system and consider all pressure losses for the water service.
- (c) Select the pressure range group in Table A-2.6.3.1.(2)-A that is consistent with the minimum static pressure available including any other losses.
- (d) Select the length column in Table A-2.6.3.1.(2)-A that is equal to or greater than the developed length from the property line or private water supply system to the water service entry point to the building.
- (e) In that column, find the fixture unit value that is equal to or greater than the fixture unit demand for the installation and follow the row back to the first column to locate the nominal pipe size of the water service pipe.
- (f) To establish the adjusted static pressure available where the water service enters the building for sizing the water distribution system, subtract the actual static pressure losses for the water service from the minimum static pressure available at the property line.
- (g) The adjusted static pressure available where a private water supply system is installed should be the static pressure available from such a system at the entry to the building.

##### Step 2: Hot Water Piping (see Table A-2.6.3.1.(2)-C)

- (a) Start with the most remote outlet in the most distant occupancy that requires hot water.
- (b) Use the sum of the total fixture unit values given in Tables 2.6.3.2.-A, 2.6.3.2.-B, 2.6.3.2.-C and 2.6.3.2.-D and work back toward the service water heater, adding in the fixture unit values as they occur.
- (c) Select the pressure range group in Table A-2.6.3.1.(2)-A that is consistent with the minimum static pressure available at the water service entry and any other losses (e.g. elevation or devices such as backflow preventers, etc.). Use this pressure range group for all portions (hot and cold) of the water distribution system.
- (d) Select the length column that is equal to or greater than the developed length from the water service entry point to the building to the most remote outlet served with either hot or cold water.

- (e) In that column, find the fixture unit value that is equal to or greater than the fixture unit demand at each pipe and follow the row back to the second column to locate the nominal pipe size of the water distribution system.

Step 3: Cold Water Piping (see Table A-2.6.3.1.(2)-D)

- (a) Start with the most remote outlet on the cold water piping using the established total developed length column and pressure range group in Table A-2.6.3.1.(2)-A and work through Steps 2(c), (d) and (e) for hot water piping.
- (b) Use the sum of the total fixture unit values given in Tables 2.6.3.2.-A, 2.6.3.2.-B, 2.6.3.2.-C and 2.6.3.2.-D and work back toward the water service entry.
- (c) Where the service water heater distribution pipe occurs, add in the fixture unit demand of the fixtures served only with hot water and those that have not yet been added in as served to the cold water side of the most remote fixtures requiring both a hot and cold water supply.
- (d) Continue by sizing the cold water main between the service water heater distribution pipe and the water service entry.
- (e) Add in the fixtures served with cold water only from the main within the most remote occupancy as they occur and all common distribution piping serving hot and cold water to other occupancies as they occur.
- (f) Complete by sizing all distribution piping served by the main within the most remote occupancy and then the other occupancies not yet sized using the previously established total developed length and pressure range group in Table A-2.6.3.1.(2)-A.

**Table A-2.6.3.1.(2)-A  
Nominal Pipe Sizes for Water Systems Based on Number of Fixture Units Served Using the Small Building Method<sup>(1)</sup>**

Water Service Pipe, NPS	Water Distribution System, NPS	Maximum Allowable Length, m														
		12	18	24	30	46	61	76	91	122	152	183	213	244	274	305
		Number of Fixture Units Served														
		Flow Velocity, m/s			3.0	2.4	1.5									
Pressure Range 200 to 310 kPa																
¾	½	6	5	4	3	2	1	1	1	0	0	0	0	0	0	0
¾	⅝	12	10	9	7	5	3	3	3	2	2	1	1	1	1	0
¾	¾	18	16	14	12	9	6	5	5	4	4	3	2	2	2	1
1	1	36	31	27	25	20	17	15	13	12	10	8	6	6	6	6
1½	1¼	83	68	57	48	38	32	28	25	21	18	15	12	12	11	11
1½	1½	151	124	105	91	70	57	49	45	36	31	26	23	21	20	20
2	1½	151	151	132	110	80	64	53	46	38	32	27	23	21	20	20
2	2	359	329	292	265	217	185	164	147	124	96	70	61	57	54	51
2½	2½	445	418	390	370	330	300	280	265	240	220	198	175	158	143	133
Pressure Range 311 to 413 kPa																
¾	½	8	7	6	5	4	3	2	2	1	1	1	0	0	0	0
¾	⅝	13	13	12	11	9	7	5	5	3	3	2	2	1	1	1
¾	¾	21	21	19	17	14	11	9	8	6	5	4	4	3	3	3
1	1	42	42	41	36	30	25	23	20	18	15	12	10	9	8	8
1½	1¼	83	83	83	83	66	52	44	39	33	29	24	20	19	17	16
1½	1½	151	151	151	151	128	105	90	78	62	52	42	38	35	32	30
2	1½	151	151	151	151	150	117	98	84	67	55	42	38	35	32	30
2	2	359	359	359	359	359	318	280	250	205	165	142	123	110	102	94
2½	2½	611	611	610	580	535	500	470	440	400	365	335	315	285	267	250

**Table A-2.6.3.1.(2)-A (Continued)**

Water Service Pipe, NPS	Water Distribution System, NPS	Maximum Allowable Length, m														
		12	18	24	30	46	61	76	91	122	152	183	213	244	274	305
		Number of Fixture Units Served														
		Flow Velocity, m/s			3.0	2.4	1.5									
Pressure Over 413 kPa																
¾	½	8	8	7	6	5	4	3	3	2	1	1	1	1	1	0
¾	⅝	13	13	13	13	11	8	7	6	5	4	3	3	3	2	2
¾	¾	21	21	21	21	17	13	11	10	8	7	6	6	5	4	4
1	1	42	42	42	42	38	32	29	26	22	18	14	13	12	12	11
1½	1¼	83	83	83	83	83	74	62	54	43	34	26	25	23	22	21
1½	1½	151	151	151	151	151	151	130	113	88	73	51	51	46	43	40
2	1½	151	151	151	151	151	151	142	122	98	82	64	51	46	43	40
2	2	359	359	359	359	359	359	359	340	288	245	204	172	153	141	129
2½	2½	611	611	611	611	611	611	610	570	510	460	430	404	380	356	329

**Notes to Table A-2.6.3.1.(2)-A:**

(1) Where total fixture unit values exceed those given in this Table, the system must be designed according to a detailed engineering design method.

**Table A-2.6.3.1.(2)-B**  
**Sizing of Water Service Pipe Using Figure A-2.6.3.1.(2)-A and Table A-2.6.3.1.(2)-A<sup>(1)</sup>**

Fixture Units	Nominal Pipe Size
Total demand from Table A-2.6.3.1.(2)-E	210.8
Add in fixture units for fire sprinkler system, irrigation system and any other demands on water service	n/a in this example
<b>Total demand in this example</b>	<b>210.8</b>
	<b>2</b>

**Notes to Table A-2.6.3.1.(2)-B:**

(1) Based on 30 m developed length and minimum static pressure at property line of 565 kPa.

**Table A-2.6.3.1.(2)-C**  
**Sizing of Hot Water System Using Figure A-2.6.3.1.(2)-A and Table A-2.6.3.1.(2)-A with Pressure Drop<sup>(1)</sup>**

Pipe Number	Hot Water, fixture units	Nominal Pipe Size, NPS
1	8	¾
2	11	¾
3	15	1
4	6	⅝
5	21	1
<b>Total Fixture Units</b>	<b>21</b>	<b>1</b>

**Notes to Table A-2.6.3.1.(2)-C:**

(1) Based on 76 m developed length and adjusted static pressure at building entry of 540 kPa.

**Table A-2.6.3.1.(2)-D**  
**Sizing of Cold Water System Using Figure A-2.6.3.1.(2)-A and Table A-2.6.3.1.(2)-A<sup>(1)</sup>**

Pipe Letter	Cold Water, fixture units	Nominal Pipe Size, NPS
A	11	¾
B	21	1
C	21	1
D	29.8	1¼
E	20	1
F	49.8	1¼
G	20	1
H	69.8	1½
I	20	1
J	89.8	1½
K	20	1
L	109.8	1½
M	60	1¼
N	169.8	2
O	20	1
P	189.8	2
Q	21	1
R	210.8	2
Total Fixture Units	210.8	2

**Notes to Table A-2.6.3.1.(2)-D:**

(1) Based on 76 m developed length and minimum adjusted static pressure at building entry of 540 kPa.



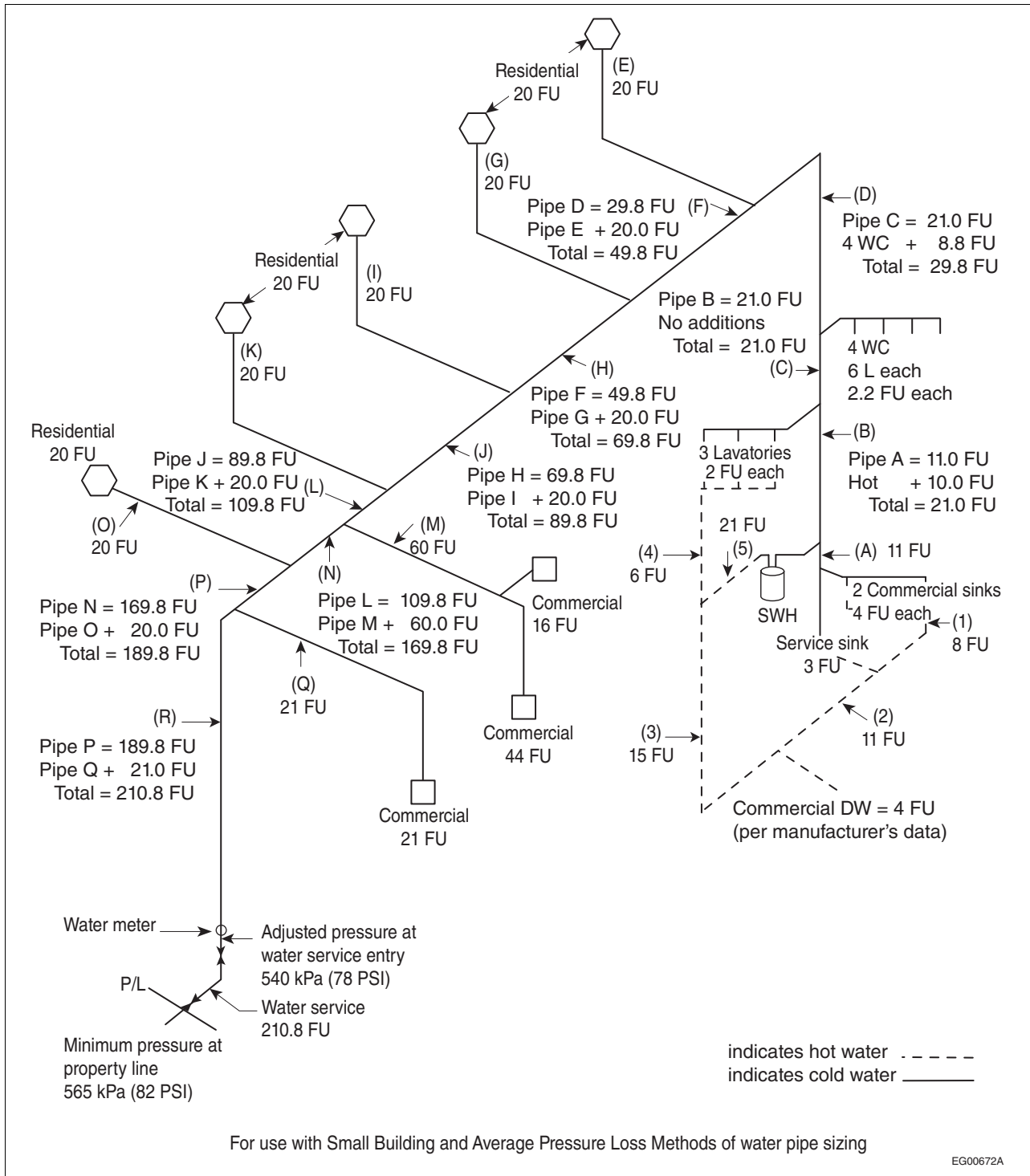


Figure A-2.6.3.1.(2)-A

Example of commercial and residential development to be used with water pipe sizing methods

Notes to Figure A-2.6.3.1.(2)-A:

- (1) This example is a development with 4 commercial occupancies on the lower floor and 5 residential occupancies on the upper floor, all with separate service water heaters.
- (2) For the purpose of water pipe sizing:
  - the minimum adjusted pressure available at building entry is 540 kPa (78 PSI);
  - the developed length of the water service is 30 m (98 ft); and
  - the developed length of the water distribution system is 76 m (249 ft).

**Table A-2.6.3.1.(2)-E**  
**Fixture Units Summary for Figure A-2.6.3.1.(2)-A Using Tables 2.6.3.2.-A, 2.6.3.2.-B, 2.6.3.2.-C and 2.6.3.2.-D**

Fixtures	Quantity	100% Fixture Unit Values	Total Demand (Quantity × Fixture Unit Values)
Lavatory, 8.3 LPM or less	3	2	6
Commercial sink	2	4	8
Service sink	1	3	3
WC, 6 LPM or less	4	2.2	8.8
Commercial dishwasher	1	4	4
Commercial occupancy	1	16	16
Commercial occupancy	1	44	44
Commercial occupancy	1	21	21
Residential occupancy	5	20	100
Total Fixture Units			210.8

**Average Pressure Loss Method**

Information required if using this method:

- (a) The developed length:
  - (i) from the property line or private water system when located outside the building to the water service entry point to the building, and
  - (ii) from the building entry of the water service to the most remote water outlet.
- (b) Minimum static pressure:
  - (i) the minimum static pressure available at the property line or other water source (private water supply system), or
  - (ii) where there is a wide fluctuation of pressure in the main throughout the day, the minimum static pressure available.
- (c) Pressure losses:
  - (i) losses for meters, pressure-reducing valves, backflow preventers, water treatment systems, and any other devices, and
  - (ii) losses or gains due to changes in elevation.
- (d) The number of fixture units as determined by using the sum of the total values given in Tables 2.6.3.2.-A, 2.6.3.2.-B, 2.6.3.2.-C and 2.6.3.2.-D.
- (e) The maximum velocities permitted in accordance with the manufacturer’s recommendations for the pipe and fittings chosen for the installation.

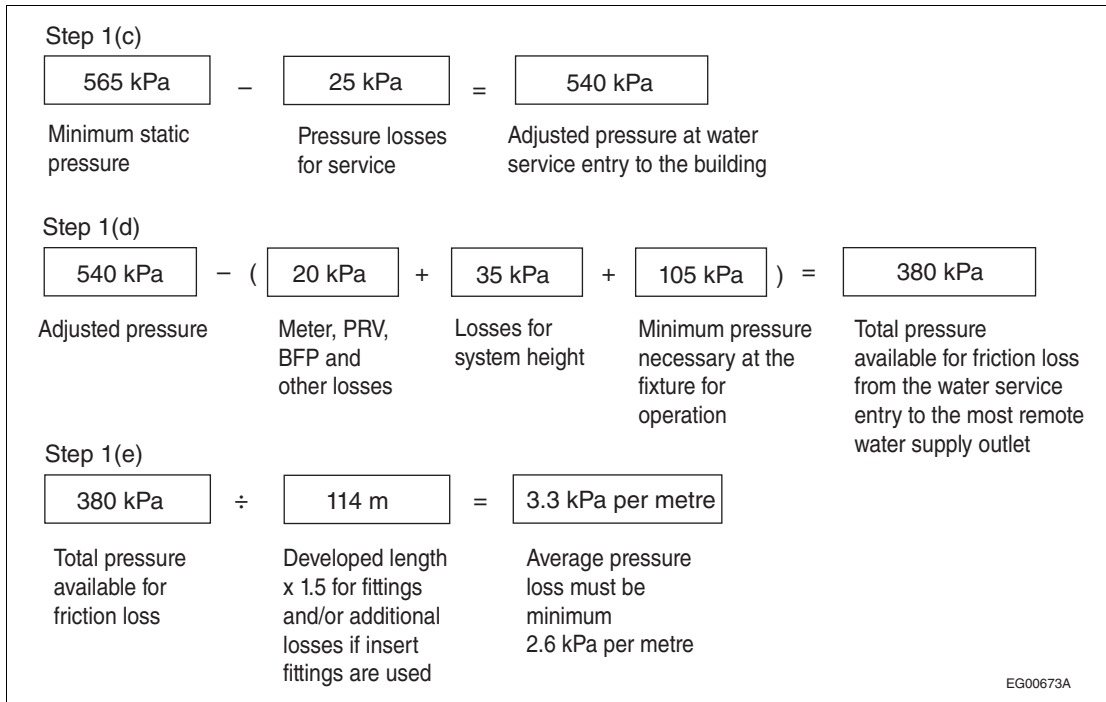
Note: The private water supply system must be capable of meeting the demands of the water distribution system.

To use this method, calculate the pressure available for friction loss which must be 2.6 kPa per metre or more; if it is less than that, the system must be designed according to a detailed engineering design method.

**Calculating Pressure Available for Friction Loss (see Figure A-2.6.3.1.(2)-B)**

- (a) Obtain the water service size, including pressure losses, and the design of the private water supply system if it is separate from the water distribution system.
- (b) To calculate the total equivalent length for the water distribution system, determine the developed length from the water service entry point to the building to the most remote water outlet, and
  - (i) where fitting inside diameter dimensions are at least equal to the NPS, multiply the developed length by 1.5 to allow for friction losses, and
  - (ii) where insert fittings are used, apply additional losses in accordance with the fitting manufacturer’s data.
- (c) To determine the adjusted pressure available at the water service entry for sizing the water distribution system, deduct the pressure losses for the water service from the minimum static pressure available at the property line or private water source.

- (d) To obtain the pressure available for friction loss, use the minimum adjusted static pressure available at the water service entry and deduct the minimum operating pressure necessary at the most remote water outlet, and losses for meters, pressure-reducing valves, backflow preventers, water treatment systems, and any other devices. Include pressure losses or gains due to changes in elevation between the water service entry and the most remote water outlet.
- (e) Divide the static pressure available for friction loss by the total equivalent length to obtain the pressure available for friction loss per metre.



**Figure A-2.6.3.1.(2)-B**  
**Determination of pressure available for friction loss**

**Pipe Sizing Procedures (see Figure A-2.6.3.1.(2)-A)**

**Step 1: Water Service Piping (see Table A-2.6.3.1.(2)-G)**

- (a) Obtain the total fixture units required for the installation using the sum of the total values given in Tables 2.6.3.2.-A, 2.6.3.2.-B, 2.6.3.2.-C and 2.6.3.2.-D and consider all other demands on the water supply.
- (b) Select the water service pipe size from Table A-2.6.3.1.(2)-F using the velocity column that is consistent with the pipe and fittings chosen for the installation.
- (c) Determine the minimum static pressure available at the property line or private water source and consider all pressure losses for the water service.
- (d) To establish the adjusted static pressure available where the water service enters the building for sizing the water distribution system, subtract the actual static pressure losses for the water service from the minimum static pressure available at the property line.
- (e) The adjusted static pressure available where a private water supply system is installed should be the static pressure available from such a system at the entry to the building.

**Step 2: Hot Water Piping (see Table A-2.6.3.1.(2)-H)**

- (a) Start with the most remote outlet in the most distant occupancy that requires hot water.
- (b) Use the sum of the total fixture unit values given in Tables 2.6.3.2.-A, 2.6.3.2.-B, 2.6.3.2.-C and 2.6.3.2.-D and work back toward the service water heater, adding in the fixture unit values as they occur.
- (c) Size the hot water system according to Table A-2.6.3.1.(2)-F using the velocity column that is consistent with the manufacturer's requirements for the pipe and fittings chosen when serving a hot water system.

Step 3: Cold Water Piping (see Table A-2.6.3.1.(2)-I)

- (a) Start with the most remote outlet requiring cold water in the most distant occupancy and working back towards the water service entry adding in the fixture unit values as they occur.
- (b) Obtain the fixture units using the sum of the total fixture unit values given in Tables 2.6.3.2.-A, 2.6.3.2.-B, 2.6.3.2.-C and 2.6.3.2.-D.
- (c) Size the cold water system to Table A-2.6.3.1.(2)-F using the velocity column that is consistent with the manufacturer's requirements for the pipe and fittings chosen when serving a cold water system.
- (d) Where the service water heater distribution pipe occurs, add in the fixture unit demand of the fixtures served with only hot water and those that have not yet been added in as served to the cold water side of the most remote fixtures requiring both hot and cold water supply.
- (e) Continue by sizing the cold water main between the service water heater distribution pipe and the water service entry.
- (f) Add in the fixtures served with only cold water from the main within the most remote occupancy as they occur and then all common distribution piping serving hot and cold water to other occupancies as they occur.
- (g) Complete by sizing all distribution piping served by the main in the most remote occupancy and then the other occupancies not yet sized using Table A-2.6.3.1.(2)-F.

**Table A-2.6.3.1.(2)-F  
Nominal Pipe Sizes for Water Systems Based on Number of Fixture Units Served Using the Average Pressure Loss Method**

Nominal Pipe Size	Water Velocity							
	3.0 m/s (10 ft/s)		2.4 m/s (8 ft/s)		1.5 m/s (5 ft/s)		1.2 m/s (4 ft/s)	
	Flow and Fixture Units Served							
	L/s	Fixture Units	L/s	Fixture Units	L/s	Fixture Units	L/s	Fixture Units
½	0.46	8	0.36	7	0.23	3.5	0.18	2.5
⅝	0.68	13	0.54	11	0.34	6.5	0.27	4.5
¾	0.95	21	0.77	17	0.48	9	0.38	7.5
1	1.62	42	1.26	30	0.81	18	0.65	14
1¼	2.47	83	1.8	54	1.24	29	0.99	22
1½	3.5	146	2.8	102	1.75	46	1.4	34
2	6.08	337	4.92	265	3.04	120	2.43	81
2½	9.39	692	7.89	500	4.69	245	3.75	170
3	13.23	1 018	10.73	750	6.7	400	5.36	295
4	23.94	2 480	18.9	1 800	11.78	850	9.42	600
5	37	4 400	29	3 350	18.35	1 625	14.68	1 125
6	52.1	6 600	42	4 800	26.38	2 875	21.11	2 125

**Table A-2.6.3.1.(2)-G  
Sizing of Water Service Pipe Using Figure A-2.6.3.1.(2)-A and Table A-2.6.3.1.(2)-F<sup>(1)</sup>**

Fixture Units	Nominal Pipe Size
Total demand from Table A-2.6.3.1.(2)-E	210.8
Add in fixture units for fire sprinkler system, irrigation system and any other demands on water service	n/a in this example
Total demand in this example	210.8
	2

**Notes to Table A-2.6.3.1.(2)-G:**

<sup>(1)</sup> Based on 30 m developed length and minimum static pressure at property line of 565 kPa.

**Table A-2.6.3.1.(2)-H**  
**Sizing of Hot Water System Using Figure A-2.6.3.1.(2)-A and Table A-2.6.3.1.(2)-F with Flow Velocity<sup>(1)</sup>**

Pipe Number	Hot Water, fixture units	Nominal Pipe Size, NPS
1	8	3/4
2	11	1
3	15	1
4	6	5/8
5	21	1 1/4
Total Fixture Units	21	1 1/4

**Notes to Table A-2.6.3.1.(2)-H:**

(1) Based on 1.5 m/s and adjusted static pressure at building entry of 540 kPa.

**Table A-2.6.3.1.(2)-I**  
**Sizing of Cold Water System Using Figure A-2.6.3.1.(2)-A and Table A-2.6.3.1.(2)-F<sup>(1)</sup>**

Pipe Letter	Cold Water, fixture units	Nominal Pipe Size, NPS
A	11	5/8
B	21	1
C	21	1
D	29.8	1
E	20	1
F	49.8	1 1/4
G	20	1
H	69.8	1 1/2
I	20	1
J	89.8	1 1/2
K	20	1
L	109.8	2
M	60	1 1/2
N	169.8	2
O	20	1
P	189.8	2
Q	21	1
R	210.8	2
Total Fixture Units	210.8	2

**Notes to Table A-2.6.3.1.(2)-I:**

(1) Based on 2.4 m/s velocity and adjusted static pressure at water service entry of 540 kPa.

**A-2.6.3.2.(4) Sizing for Flush Valves.** Distribution piping and water mains serving flush valves may be sized using the values assigned in Tables 2.6.3.2.-B and 2.6.3.2.-C, beginning with the most remote flush valve on each section of distribution piping served by the water main.

**A-2.6.3.4.(5) Sizing of Water Systems.** Sentence 2.6.3.4.(5) and Table 2.6.3.4. present a simplified method of water system sizing, which is permitted in buildings containing one or two dwelling units or row houses with separate water services.

### Simplified Method

This sizing method may be used in the buildings noted, where:

- (a) the total developed length from the property line to the most remote fixture is not more than 90 m, and
- (b) the static pressure available at the water service entry to the building is not less than 200 kPa.

Where either the developed length is exceeded or the minimum static pressure required is not known, a detailed engineering design method must be used to size the water service piping. The design must ensure a minimum static pressure of 200 kPa is available at the water service entry to the building.

Information required when using this method:

- (a) The total number of fixture units (FU) as determined by using the sum of the total fixture unit values given in Tables 2.6.3.2.-A, 2.6.3.2.-B, 2.6.3.2.-C and 2.6.3.2.-D.
- (b) Where the water service also serves a fire sprinkler system, irrigation system, or any other system, these demands must be added to the water service sizing.

### Pipe Sizing Procedures

#### Step 1: Water Service Pipe

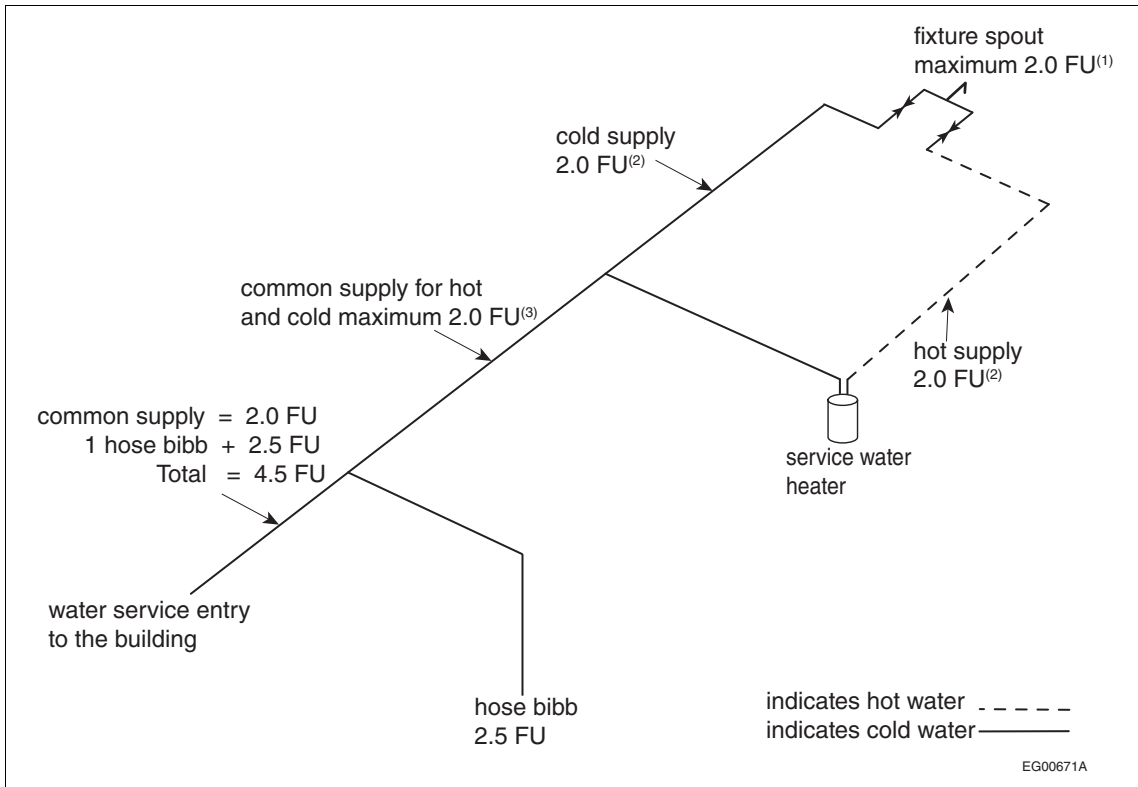
- (a) Obtain the total fixture units required for the installation using the sum of the total values given in Tables 2.6.3.2.-A, 2.6.3.2.-B, 2.6.3.2.-C and 2.6.3.2.-D and consider all other demands on the water supply.
- (b) Determine the water service pipe size using the water velocity column in Table 2.6.3.4. that is consistent with the pipe material chosen for the installation.

#### Step 2: Hot Water Piping

- (a) Start with the most remote fixture requiring a supply of hot water and work back toward the service water heater, adding in the fixture unit loads as they occur.
- (b) Determine the fixture units using the sum of the total fixture unit values given in Tables 2.6.3.2.-A, 2.6.3.2.-B, 2.6.3.2.-C and 2.6.3.2.-D.
- (c) Size the hot water system using the water velocity column in Table 2.6.3.4. that is consistent with the manufacturer's recommendations for the pipe and fittings chosen when serving a hot water system.

#### Step 3: Cold Water Piping

- (a) Start with the most remote fixture requiring a supply of cold water and work back toward the water service entry, adding in the fixture unit loads as they occur.
- (b) Obtain the fixture units using the sum of the total fixture unit values given in Tables 2.6.3.2.-A, 2.6.3.2.-B, 2.6.3.2.-C and 2.6.3.2.-D.
- (c) Size the cold water system using the water velocity column in Table 2.6.3.4. that is consistent with the manufacturer's recommendations for the pipe chosen when serving a cold water system.
- (d) Where the service water heater distribution pipe occurs, add in the fixture unit demand of the fixtures served with only hot water and those that have not yet been added in as served to the cold water side of the fixtures requiring both a hot and cold water supply.
- (e) Continue sizing the cold water main between the service water heater distribution pipe and the water service entry by adding all fixtures served with only a cold water supply as they occur.
- (f) Complete by sizing all cold water distribution piping served by the main between the water heater distribution pipe and the water service entry.



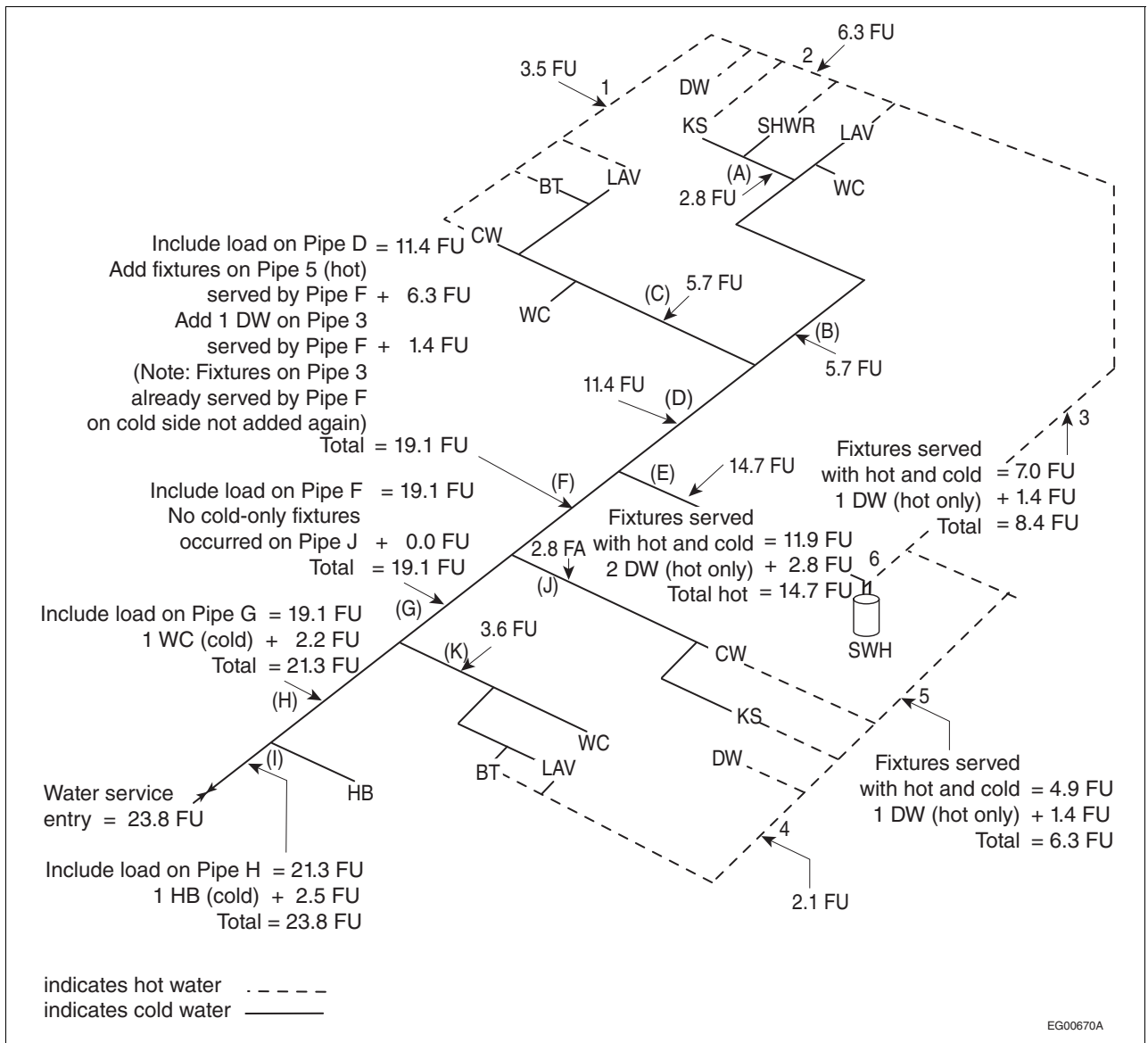
**Figure A-2.6.3.4.(5)-A**  
**Determining the hydraulic needs of a fixture**

**Notes to Figure A-2.6.3.4.(5)-A:**

- (1) The fixture spout delivers a maximum of 2.0 fixture units.
- (2) This would apply if only the hot side or the cold side were fully opened.
- (3) The common pipe that serves both the hot and cold sides of the faucet also delivers a maximum of 2.0 fixture units even if both the hot and cold valves at the faucet are fully opened at the same time.

**Table A-2.6.3.4.(5)-A**  
**Fixture Units Summary Using Figure A-2.6.3.4.(5)-B and Tables 2.6.3.2.-A, 2.6.3.2.-B, 2.6.3.2.-C and 2.6.3.2.-D**

Fixtures	Number of Fixtures	100% Fixture Unit Values	Total Demand (Quantity x Fixture Unit Values)
Bathtub	2	1.4	2.8
Clothes washer	2	1.4	2.8
Dishwasher	2	1.4	2.8
Hose bibb	1	2.5	2.5
Lavatory, 8.3 LPM or less	3	0.7	2.1
Shower, 9.5 LPM or less	1	1.4	1.4
Sink, 8.3 LPM or less	2	1.4	2.8
WC, 6 LPM or less	3	2.2	6.6
Total Fixture Units			23.8



**Figure A-2.6.3.4.(5)-B**  
Example of water pipe sizing for buildings containing one or two dwelling units or row houses with separate water services

**Table A-2.6.3.4.(5)-B**  
Sizing of Water Service Pipe Using Figure A-2.6.3.4.(5)-B and Table 2.6.3.4.

Fixture Units		Water Velocity, m/s		
		3.0	2.4	1.5
		Nominal Pipe Size, NPS		
Total fixture units	23.8	-	-	-
Fire sprinkler system	n/a	-	-	-
Irrigation system	n/a	-	-	-
Other	n/a	-	-	-
Total demand on water service	23.8	1	1	1¼



**Table A-2.6.3.4.(5)-C**  
Sizing of Hot Water System Using Figure A-2.6.3.4.(5)-B and Table 2.6.3.4.

Pipe Number	Hot Water Fixture Units	Water Velocity, m/s		
		3.0	2.4	1.5
		Nominal Pipe Size, NPS		
1	3.5	½	½	½
2	6.3	½	½	¾
3	8.4	¾	¾	¾
4	2.1	½	½	½
5	6.3	½	½	¾
6	14.7	¾	¾	1
Total Fixture Units	14.7			

**Table A-2.6.3.4.(5)-D**  
Sizing of Cold Water System Using Figure A-2.6.3.4.(5)-B and Table 2.6.3.4.

Pipe Letter	Cold Water Fixture Units	Water Velocity, m/s		
		3.0	2.4	1.5
		Nominal Pipe Size, NPS		
A	2.8	½	½	½
B	5.7	½	½	¾
C	5.7	½	½	¾
D	11.4	¾	¾	1
E	14.7	¾	¾	1
F	19.1	¾	1	1¼
G	19.1	¾	1	1¼
H	21.3	1	1	1¼
I	23.8	1	1	1¼
J	2.8	½	½	½
K	3.6	½	½	½
Total Fixture Units	23.8			

**A-2.7.1.1. Non-Potable Water System Design.** There is a growing interest in Canada in using available non-potable water supplies in the place of potable ones for selected purposes such as flushing water closets and irrigating lawns and gardens. Article 2.7.1.1. applies to non-potable water systems, regardless of the origin of the water. The non-potable water must meet applicable water quality standards as determined by an authority having jurisdiction.

**A-2.7.1.1.(1) Good Engineering Practice.** Examples of good engineering practice in the design, fabrication and installation of non-potable water systems can be found in

- the ASHRAE Handbooks,
- the ASPE Handbooks, and
- CAN/CSA-B128.1, "Design and Installation of Non-Potable Water Systems."

**A-2.7.2.1.(1) Aboveground Roof Surfaces.** While it is possible to harvest rainwater from surfaces other than above-ground roofs, such as patios, lawns, gardens, driveways, roadways, parking garages and parking lots, these surfaces are not suitable catchments for rainwater harvesting systems because of water quality concerns. Water collected from such surfaces may be contaminated with fertilizer, herbicides, fecal matter, garbage, oil or chemicals.

The outdoor environment in the local area of the building site, including its immediate surroundings, should be investigated to identify contaminants that could adversely affect the quality of the non-potable water delivered by the rainwater harvesting system. Contaminants of concern include industrial and urban traffic emissions, and pesticides and other agricultural chemicals. Other factors that can influence the levels of contaminants in the delivered non-potable water include the building's geometry, and prevailing winds and seasonal activity in the local area. Design features should be incorporated in the rainwater harvesting system to mitigate the risks associated with any identified contaminants of concern.

**A-2.7.2.2.(1) and 2.7.2.4.(3) and (4) Treatment for Use.** Harvested rainwater used in any permitted application must be treated appropriately for its intended end use.

**A-2.7.2.3.(1) Pedestrian Traffic.** The prohibition of pedestrian traffic on roof surfaces stated in Sentence 2.7.2.3.(1) is not intended to include access to roof surfaces by service personnel, such as window washers or HVAC mechanics.

**A-2.7.2.3.(2) Roofing and Conveyance Materials.** Water is considered to be the “universal solvent.” Accordingly, roofing components and conveyance systems that supply rainwater to a rainwater harvesting system should be constructed of materials that resist dissolution in water. NSF Pro 151-8-1, “Health Effects from Rainwater Catchment System Components,” although directed at potable water systems, is a useful source of information on roofing materials to consider.

**A-2.7.2.4.(1) Good Engineering Practice.** Examples of good engineering practice in the design, fabrication and installation of rainwater harvesting systems can be found in

- the ASHRAE Handbooks,
- the ASPE Handbooks,
- ARCSA/ASPE/ANSI 63, “Rainwater Catchment Systems,” and
- CSA B805/ICC 805, “Rainwater harvesting systems.”



---

## **Division C**

# **Administrative Provisions**



---

## **Division C**

# **Part 1 General**

<b>1.1.</b>	<b>Application</b>	
1.1.1.	Application .....	1-1
<b>1.2.</b>	<b>Terms and Abbreviations</b>	
1.2.1.	Definitions of Words and Phrases ..	1-1
1.2.2.	Symbols and Other Abbreviations ..	1-1



## **Division C**

# **Part 1 General**

## **Section 1.1. Application**

### **1.1.1. Application**

#### **1.1.1.1. Application**

**1)** This Part applies to all *plumbing systems* covered in this Code. (See Article 1.1.1.1. of Division A.)

## **Section 1.2. Terms and Abbreviations**

### **1.2.1. Definitions of Words and Phrases**

#### **1.2.1.1. Non-defined Terms**

**1)** Words and phrases used in Division C that are not included in the list of definitions in Article 1.4.1.2. of Division A shall have the meanings that are commonly assigned to them in the context in which they are used, taking into account the specialized use of terms by the various trades and professions to which the terminology applies.

**2)** Where objectives and functional statements are referred to in Division C, they shall be the objectives and functional statements described in Parts 2 and 3 of Division A.

**3)** Where acceptable solutions are referred to in Division C, they shall be the provisions stated in Part 2 of Division B.

**4)** Where alternative solutions are referred to in Division C, they shall be the alternative solutions mentioned in Clause 1.2.1.1.(1)(b) of Division A.

#### **1.2.1.2. Defined Terms**

**1)** The words and terms in italics in Division C shall have the meanings assigned to them in Article 1.4.1.2. of Division A.

### **1.2.2. Symbols and Other Abbreviations**

#### **1.2.2.1. Symbols and Other Abbreviations**

**1)** The symbols and other abbreviations in Division C shall have the meanings assigned to them in Article 1.4.2.1. of Division A.





---

## **Division C**

# **Part 2 Administrative Provisions**

<b>2.1.</b>	<b>Application</b>	
2.1.1.	Application .....	2-1
<b>2.2.</b>	<b>Administration</b>	
2.2.1.	Administration .....	2-1
2.2.2.	Plumbing Drawings and Related Documents .....	2-1
<b>2.3.</b>	<b>Alternative Solutions</b>	
2.3.1.	Documentation of Alternative Solutions .....	2-1
	<b>Notes to Part 2 .....</b>	<b>2-3</b>



## Division C

# Part 2 Administrative Provisions

## Section 2.1. Application

### 2.1.1. Application

#### 2.1.1.1. Application

1) This Part applies to all *plumbing systems* covered in this Code. (See Article 1.1.1.1. of Division A.)

## Section 2.2. Administration

### 2.2.1. Administration

#### 2.2.1.1. Administrative Requirements

1) This Code shall be administered in conformance with the appropriate provincial or territorial regulations, municipal bylaws or, in the absence of such regulations or bylaws, in conformance with the applicable requirements in the Administrative Requirements for Use with the National Building Code of Canada 1985.

### 2.2.2. Plumbing Drawings and Related Documents

#### 2.2.2.1. Information Required on Plumbing Drawings and Related Documents

1) Plumbing drawings and related documents submitted with the application for a plumbing permit shall show

- a) the location and *nominal pipe size* of every *building drain* and of every *trap* and *cleanout* fitting that is on a *building drain*,
- b) the location and *nominal pipe size* of every *sanitary drainage pipe*, *trap* and *vent pipe*, and
- c) a layout of the *potable water distribution system*, including *nominal pipe sizes* and valves.

## Section 2.3. Alternative Solutions

### 2.3.1. Documentation of Alternative Solutions

(See Note A-2.3.1.)

#### 2.3.1.1. Documentation

1) Documentation conforming to this Subsection shall be provided by the person requesting the use of an alternative solution to demonstrate that the proposed alternative solution complies with this Code.

- 2)** The documentation referred to in Sentence (1) shall include
  - a) a Code analysis outlining the analytical methods and rationales used to determine that the proposed alternative solution will achieve at least the level of performance required by Clause 1.2.1.1.(1)(b) of Division A, and
  - b) information concerning any special maintenance or operation requirements, including any *plumbing system* component commissioning requirements, that are necessary for the alternative solution to achieve compliance with the Code after the *plumbing system* is installed.
- 3)** The Code analysis referred to in Clause (2)(a) shall identify the applicable objectives, functional statements and acceptable solutions, and any assumptions, limiting or restricting factors, testing procedures, engineering studies or performance parameters that will support a Code compliance assessment.
- 4)** The Code analysis referred to in Clause (2)(a) shall include information about the qualifications, experience and background of the person or persons taking responsibility for the design.
- 5)** The information provided under Sentence (3) shall be in sufficient detail to convey the design intent and to support the validity, accuracy, relevance and precision of the Code analysis.
- 6)** Where the design of a *plumbing system* includes proposed alternative solutions that involve more than one person taking responsibility for different aspects of the design, the applicant for the permit shall identify a single person to co-ordinate the preparation of the design, Code analysis and documentation referred to in this Subsection.

# Notes to Part 2

## Administrative Provisions

**A-2.3.1. Documentation of Alternative Solutions.** Beyond the purposes of demonstrating compliance and acquiring an installation permit, there are other important reasons for requiring that the proponent of an alternative solution submit project documentation (i.e. a compliance report) to the authority having jurisdiction and for the authority having jurisdiction to retain that documentation for a substantial period following the installation of a plumbing system:

- Most jurisdictions require that a plumbing system be maintained in compliance with the codes under which it was installed. Alternative solutions made possible by objective-based codes may have special maintenance requirements, which would be described in the documentation.
- Documentation helps consultants perform code compliance assessments of existing buildings or facilities before they are sold and informs current owners or prospective buyers of existing buildings or facilities of any limitations pertaining to their future use or development.
- Documentation provides design professionals with the basic information necessary to design changes to an existing plumbing system.
- An alternative solution could be invalidated by a proposed alteration to a plumbing system. Designers and regulators must therefore know the details of the particular alternative solutions that were integral to the original design. Complete documentation should provide insight as to why one alternative solution was chosen over another.
- Documentation is the “paper trail” of the alternative solution negotiated between the designer and the regulator and should demonstrate that a rational process led to the acceptance of the alternative solution as an equivalency.
- It is possible that over time a particular alternative solution may be shown to be inadequate. It would be advantageous for a jurisdiction to know which plumbing systems included that alternative solution as part of their design: documentation will facilitate this type of analysis.
- Project documentation provides important information to a forensic team that is called to investigate an accident or why a design failed to provide the level of performance expected.

This subject is discussed in further detail in “Recommended Documentation Requirements for Projects Using Alternative Solutions in the Context of Objective-Based Codes,” which was prepared for the CCBFC Task Group on Implementation of Objective-Based Codes and is available on the CBHCC’s website.

---

These Notes are included for explanatory purposes only and do not form part of the requirements. The number that introduces each Note corresponds to the applicable requirement in this Part.



# Index

## A

### Abbreviations

- other abbreviations, 1.4.2.1.[A]
- proper names, 1.3.2.1.
- symbols, 1.4.2.1.[A]

Acceptable solutions, 1.1.2.1., 1.2.1.1.[A], 1.5.1.1.[A]

Accessibility of fixtures and equipment, 2.1.3.2.

Acrylonitrile-butadiene-styrene (ABS) pipe and pipe fittings, 2.2.5.9. - 2.2.5.11., 2.3.4.5., 2.4.6.4.

### Additional circuit vents

- for branches, 2.5.3.1.
- definition, 1.4.1.2.[A]
- for fixtures, 2.5.3.1.
- for fixtures draining into vent pipes, 2.5.4.5.
- sizing, 2.5.3.1., 2.5.7.3., 2.5.8.5.
- for traps, 2.5.1.1.

Administration of Code, 2.2.[C]

Air admittance valves, 1.4.1.2.[A], 2.2.10.16., 2.5.9.

Air breaks, 1.4.1.2.[A], 2.3.3.11., 2.4.2.3., 2.6.1.7.

Air gaps, 1.4.1.2.[A], 2.6.2.2., 2.6.2.3., 2.6.2.9., 2.7.2.4.

Air pressure tests, 2.3.6.1. - 2.3.6.3., 2.3.6.5., 2.3.7.1., 2.3.7.2.

Alloyed zinc, 1.4.1.2.[A], 2.2.10.14.

### Alternative solutions

- compliance with Code, 1.2.1.1.[A]
- documentation, 2.3.1.[C]

Ancillary buildings, 2.1.2.4.

### Application of Code

- Division A, 1.3.2.[A]
- Division B, 1.3.3.[A]
- Division C, 1.3.4.[A]
- general, 1.1.1.1.[A]

Autopsy tables, 2.4.9.3.

Auxiliary water supply, 1.4.1.2.[A]

## B

Backfilling of pipe trench, 2.3.5.1.

### Backflow

- caused by back pressure, 2.6.2.3., 2.6.2.4.
- definition, 1.4.1.2.[A]
- from fire protection systems, 2.6.2.4.
- protection of building drains, 2.4.6.4.
- protection of drainage pans on heating/cooling units, 2.4.2.1.

protection of drinking fountains, 2.4.2.1.

protection of make-up water, 2.7.2.4.

protection of potable water system, 2.6.2.6., 2.6.2.7., 2.7.2.4.

protection of rainwater storage tanks, 2.7.2.4.

### Backflow preventers

- for back-siphonage prevention, 2.6.2.2.
- definition, 1.4.1.2.[A]
- fire protection systems, used in, 2.6.2.4.
- installation, 2.6.2.1.
- maintenance of effectiveness, 2.6.2.12.
- for premise isolation, 2.6.2.6.
- protection against thermal expansion, 2.6.1.11.
- standards for, 2.2.10.10.

### Back pressure

- backflow caused by, 2.6.2.3.
- definition, 1.4.1.2.[A]
- fire protection systems, 2.6.2.4.

### Back-siphonage

- definition, 1.4.1.2.[A]
- with direct flush valves, 2.2.10.8.
- fire protection systems, 2.6.2.4.
- prevention, 2.6.2.2.
- with relief valves, 2.6.1.7.

### Back-siphonage preventers

- definition, 1.4.1.2.[A]
- standards for, 2.2.10.10.
- for tank-type water closets, 2.6.2.11.

### Backwater valves

- definition, 1.4.1.2.[A]
- protection of branches, 2.4.6.4.
- protection of building drains, 2.4.6.4.
- protection of drainage pans on heating/cooling units, 2.4.2.1.
- protection of drinking fountains, 2.4.2.1.
- protection of rainwater storage tanks, 2.7.2.4.
- protection of sumps, 2.4.3.6., 2.4.6.3.

Ball tests, 2.3.6.1., 2.3.6.2., 2.3.6.7.

Bathroom group, 1.4.1.2.[A], 2.4.9.3., 2.6.3.2.

Bathtubs, 2.2.2.2., 2.2.10.7., 2.4.9.3., 2.6.3.2.

Bedpan washers, 2.6.3.2.

Beer cabinets, 2.4.9.3.

Bell and spigot pipe, 2.3.2.7.

Bell traps, 2.2.3.1.

Bidets, 2.4.9.3., 2.6.3.2.

Bolts, 2.2.10.2., 2.2.10.3.

### Branches

- definition, 1.4.1.2.[A]

[A] – Reference occurs in Division A. [C] – Reference occurs in Division C. All other references occur in Division B.



- hydraulic loads, 2.4.10.6., 2.4.10.7.
  - protection from backflow, 2.4.6.4.
  - serving water closets, 2.4.9.2.
  - sizing, 2.4.9.2.
  - Branch vents
    - definition, 1.4.1.2.[A]
    - protection of drainage systems, 2.5.1.1.
    - sizing, 2.5.7.2., 2.5.8.3.
  - Brass floor flanges, 2.2.10.1.
  - Brass pipe, 2.2.7.1., 2.3.4.5.
  - Brass pipe flanges and flanged fittings, 2.2.7.2.
  - Brass threaded water fittings, 2.2.7.3.
  - Brazing alloys, 2.2.9.2.
  - Bronze pipe flanges and flanged fittings, 2.2.7.2.
  - Bronze threaded water fittings, 2.2.7.3.
  - Building drains
    - cleanouts, 2.4.7.1., 2.4.7.2.
    - combined, 1.4.1.2.[A], 2.1.2.1., 2.4.6.1.
    - definition, 1.4.1.2.[A]
    - drawings for plumbing permit, 2.2.2.1.[C]
    - hydraulic loads, 2.4.10.6., 2.4.10.8., 2.4.10.9.
    - protection from backflow, 2.4.6.4.
    - protection from damage, 2.3.5.
    - sanitary, 1.4.1.2.[A], 2.4.2.1., 2.4.6.1., 2.4.6.2.
    - sizing, 2.4.9.1., 2.4.9.2., 2.4.9.4.
    - storm, 1.4.1.2.[A], 2.4.10.9.
    - venting, 2.5.7.2., 2.5.8.4.
  - Buildings
    - ancillary, 2.1.2.4.
    - definition, 1.4.1.2.[A]
  - Building sewers
    - cleanouts, 2.4.7.1., 2.4.7.2.
    - combined, 1.4.1.2.[A], 2.4.5.2., 2.4.10.9.
    - definition, 1.4.1.2.[A]
    - developed length, 2.4.7.2.
    - hydraulic loads, 2.4.10.6., 2.4.10.8., 2.4.10.9.
    - mobile homes, 2.4.6.5.
    - sanitary, 1.4.1.2.[A], 2.4.7., 2.4.10.8.
    - sizing, 2.4.7.2., 2.4.9.4.
  - Building traps
    - cleanouts, 2.4.5.4.
    - definition, 1.4.1.2.[A]
    - fresh air inlets, 2.5.1.1., 2.5.5.4.
    - location, 2.4.5.4.
    - for sanitary drainage systems, 2.4.5.1., 2.4.5.3.
    - seals, 2.4.5.5.
    - for storm drainage systems, 2.4.5.2.
  - Butt fusion fittings, 2.2.5.4.
  - Butt weld pipe fittings, 2.3.2.8.
- C**
- Care, treatment or detention occupancy, 1.4.1.2.[A], 2.4.4.3.
  - Cast-iron drainage and vent pipe and fittings, 2.2.6.1., 2.2.6.3.
  - Cast-iron fittings, 2.2.6.1., 2.2.6.3., 2.2.6.5.
  - Cast-iron fixtures, 2.2.2.2.
  - Cast-iron pipes, 2.3.2.1., 2.3.3.3., 2.3.3.8., 2.3.4.5.
  - Cast-iron traps, 2.2.3.1., 2.3.3.8.
  - Cast-iron water pipe and fittings, 2.2.6.4., 2.2.6.5.
  - Catch basins
    - cast-iron frames and covers for, 2.2.6.2.
    - concrete, 2.2.5.2.
  - Caulked lead drainage joints, 2.3.2.1.
  - Caulking compounds, 2.3.2.7.
  - Cellular core PVC pipe and fittings, 2.2.5.16.
  - Cement mortar, 2.2.9.1.
  - Cement-mortar lining, 2.2.6.4.
  - Ceramic china fixtures, 2.2.2.2.
  - Check valves, 1.4.1.2.[A], 2.6.1.5., 2.6.1.11.
    - for backflow prevention, 2.4.6.4., 2.6.2.3., 2.6.2.4.
    - for back-siphonage prevention, 2.6.2.2.
    - protection of drainage pans on heating/cooling units, 2.4.2.1.
    - protection of drinking fountains, 2.4.2.1.
    - protection of pumped sump, 2.4.6.3.
  - Chemical storage locations, 2.4.3.4.
  - Chlorinated polyvinyl chloride (CPVC) pipe and fittings, 2.2.5.8., 2.2.5.9., 2.2.5.11., 2.3.4.5.
  - Circuit vents
    - additional (see Additional circuit vents)
    - for branches, 2.5.3.1.
    - definition, 1.4.1.2.[A]
    - for fixtures, 2.5.3.1.
    - for fixtures draining into vent pipes, 2.5.4.5.
    - sizing, 2.5.7.3., 2.5.8.3.
    - for traps, 2.5.1.1.
  - Classes of fire sprinkler/standpipe systems, 1.4.1.2.[A], 2.6.2.4.
  - Cleaning of potable water systems, 2.6.2.8.
  - Cleanouts
    - accessibility for cleaning and maintenance, 2.1.3.2.
    - definition, 1.4.1.2.[A]
    - for drainage systems, 2.4.7.1.
    - drawings for plumbing permit, 2.2.2.1.[C]
    - fittings, 2.2.10.3., 2.4.7.1.
    - installation, 2.4.7.
    - location, 2.1.3.2., 2.4.7.1., 2.4.7.4.
    - manholes as, 2.4.7.1., 2.4.7.3., 2.5.7.6.
    - rodding, 2.4.7.2., 2.4.7.4.
    - sizing and spacing, 2.4.7.2.
    - for traps, 2.2.3.1., 2.4.5.2. - 2.4.5.4., 2.4.7.1., 2.4.7.4.
  - Clear-water waste, 1.4.1.2.[A], 2.4.2.1., 2.4.4.2., 2.4.5.1.
  - Climatic data, for hydraulic load determination, 2.4.10.4.
  - Clothes washers, 2.4.2.1., 2.4.5.1., 2.4.9.3., 2.6.3.2., 2.7.2.2.
  - Cold-caulked joints, 2.3.2.7.
  - Combined building drains
    - definition, 1.4.1.2.[A]
    - hydraulic loads, 2.4.10.9.
    - restrictions on use, 2.1.2.1., 2.4.6.1.
  - Combined sewers
    - connections, 2.1.2.1., 2.1.2.2., 2.4.5.2.
    - definition, 1.4.1.2.[A]
  - Combined temperature- and pressure-relief valves, 2.2.10.11., 2.6.1.7.
  - Combustible
    - definition, 1.4.1.2.[A]
    - pipng, 2.2.5.11.

Compliance  
 with Code, 1.2.1.1.[A]  
 materials, systems and equipment, 1.2.2.[A]  
 Concrete pipe and fittings, 2.2.5.2.  
 Condensation, protection against, 2.3.5.5.  
 Conflicting requirements, 1.5.1.2.[A]  
 Connections  
 direct, 1.4.1.2.[A], 2.4.2.1., 2.4.2.3.  
 of dissimilar materials, 2.3.3.6.  
 drainage systems, 2.1.2.1., 2.1.2.2., 2.4.2., 2.4.3.4.,  
 2.4.5.3.  
 of drains, 2.4.2.1., 2.4.2.3., 2.4.3.4., 2.4.3.6.  
 of fixtures, 2.4.2.1. - 2.4.2.3., 2.4.3.4., 2.4.4.4., 2.5.4.2.,  
 2.5.5.5., 2.5.6.4.  
 increasers, 2.3.3.5.  
 indirect, 1.4.1.2.[A], 2.3.3.11., 2.4.2.1., 2.4.3.2.,  
 2.4.4.4., 2.4.5.1.  
 lead bend, 2.4.2.1.  
 nominally horizontal offset, 2.4.2.1.  
 nominally horizontal sanitary drainage pipe,  
 2.4.2.1.  
 of outlet fixtures, 2.3.3.8.  
 of overflows from rainwater tanks, 2.4.2.2., 2.7.2.4.  
 reducers, 2.3.3.5.  
 of roof drains, 2.3.3.7.  
 running thread and packing nut, 2.3.3.4.  
 of separate services, 2.1.2.4.  
 of storm drainage systems, 2.1.2.2., 2.4.5.2.  
 of subsoil drainage, 2.4.5.3., 2.4.6.4.  
 unions and slip joints, 2.3.3.4.  
 of vent pipes and circuit venting, 2.4.2.1., 2.5.3.,  
 2.5.5.5., 2.5.6.2., 2.5.6.4.  
 of water systems, 2.1.2.3., 2.6.2.1., 2.6.2.3., 2.6.2.4.,  
 2.7.1.1.  
 Contamination protection  
 hazardous waste, 2.4.7.4.  
 potable water systems, 2.6.2.  
 Continuous vents, 1.4.1.2.[A], 2.5.1.1., 2.5.2.1., 2.5.8.3.  
 Cooling of hot liquid waste, 2.4.4.2.  
 Copper joints, 2.3.3.12.  
 Copper pipe, 2.2.7.1., 2.3.4.3., 2.3.4.5.  
 Copper tube, 2.2.7.4., 2.3.3.2., 2.3.3.10., 2.3.4.3.  
 Corrosion-resistant materials, 2.2.2.1., 2.2.8., 2.2.10.2.,  
 2.4.7.3.  
 Couplings  
 corrugated steel, 2.2.6.8.  
 mechanical, 2.2.10.4.  
 CPVC (Chlorinated polyvinyl chloride) pipe and  
 fittings, 2.2.5.8., 2.2.5.9., 2.2.5.11., 2.3.4.5.  
 Critical level, 1.4.1.2.[A], 2.6.2.10.  
 Cross fittings, 2.2.4.1.  
 Crosslinked polyethylene/aluminum/crosslinked  
 polyethylene (PEX/AL/PEX) pipe and fittings,  
 2.2.5.13., 2.3.4.5.  
 Crosslinked polyethylene pipe and fittings, 2.2.5.6.,  
 2.3.4.5.  
 Cuspidors, 2.4.9.3., 2.6.3.2.

## D

Dead ends in piping, 1.4.1.2.[A], 2.4.6.1.  
 Definitions  
 defined terms, 1.4.1.2.[A]  
 non-defined terms, 1.4.1.1.[A]  
 Dental units, 2.4.9.3., 2.6.3.2.  
 Detention occupancy (see Care, treatment or  
 detention occupancy)  
 Developed length  
 of branch vents, 2.5.8.3.  
 of building sewers, 2.4.7.2.  
 of circuit vents, 2.5.8.3.  
 of continuous vents, 2.5.8.3.  
 definition, 1.4.1.2.[A]  
 of fixture outlet pipes, 2.4.8.2.  
 of potable water distribution systems, 2.6.1.1.  
 of stack vents, 2.5.8.4.  
 of trap arm for vent pipes, 2.5.6.3.  
 of vent headers, 2.5.8.3.  
 Dilution tanks, 2.4.4.4., 2.5.5.3., 2.5.7.7., 2.5.8.5.  
 Direct flush valves, 2.2.10.8.  
 Directly connected  
 definition, 1.4.1.2.[A]  
 fixture outlet pipes, 2.4.2.3.  
 fixtures, 2.4.2.1.  
 Dishwashers, 2.4.5.1., 2.4.9.3., 2.6.3.2.  
 Dishwashing sinks, overflows, 2.2.2.4.  
 Dissimilar materials, joints and connections for,  
 2.3.3.6.  
 Documents  
 plumbing drawings and related documents,  
 2.2.2.1.[C]  
 referenced, 1.5.1.[A]  
 Downspouts (see Leaders)  
 Drainage equipment, 2.4.6.3.  
 Drainage fittings  
 cast-iron, 2.2.6.3.  
 solder-joint, 2.2.7.5.  
 Drainage joints, caulked lead, 2.3.2.1.  
 Drainage pans, 2.4.2.1., 2.6.1.7.  
 Drainage piping  
 arrangement, 2.4.6.  
 cast iron, 2.2.6.1.  
 hydraulic loads, 2.4.10.  
 location, 2.4.6.2.  
 minimum slope and length, 2.4.8.  
 potable water distribution systems, 2.6.1.2.  
 sizing, 2.4.9.  
 Drainage systems  
 application of Code, 1.1.1.1.[A]  
 arrangement of piping, 2.4.6.  
 cleanouts, 2.4.7.  
 connections, 2.1.2.1., 2.1.2.2., 2.4.2., 2.4.3.4., 2.4.5.3.  
 definition, 1.4.1.2.[A]  
 materials and equipment, 2.2.1.1.  
 piping and fittings, 2.2.4.1., 2.2.5.3., 2.2.5.9., 2.2.6.,  
 2.2.7.3., 2.2.7.4.  
 sanitary, 2.1.2.1., 2.4.2.1., 2.4.4.1., 2.4.5.1., 2.4.7.1.  
 size of pipes, 2.4.9.  
 storm, 2.1.2.2., 2.4.5.2., 2.4.7.1.

testing, 2.3.6.  
 traps, 2.2.3.1., 2.4.5.1., 2.4.5.2.  
 treatment of sewage and wastes, 2.4.4.  
 venting, 2.5.1.1., 2.5.6.4.  
 Drains (see Building drains; Fixture drains; Floor drains; Roof drains)  
 Drawings and related documents, 2.2.2.[C]  
 Drilled and tapped joints, 2.3.3.1.  
 Drinking fountain bubblers, 2.2.10.9.  
 Drinking fountains, 2.4.2.1., 2.4.5.1., 2.4.9.3., 2.6.3.2.  
 Drum traps, 2.2.3.1.  
 Dual vents, 1.4.1.2.[A], 2.5.1.1., 2.5.8.2., 2.5.9.1.  
 Dwelling units, 1.4.1.2.[A], 2.6.3.1., 2.6.3.4.

## E

Eavestroughs (see Roof gutters)  
 Ejectors for sumps, 2.4.6.3.  
 Elbow (90°) fittings, 2.2.4.3.  
 Electrical insulation of piping supports, 2.3.4.3.  
 Elevator pits, 2.4.3.6.  
 Emergency floor drains, 1.4.1.2.[A], 2.5.2.1.  
 Enamelled fixtures, 2.2.2.2.  
 Expansion and contraction, piping system, 2.3.3.9., 2.6.1.11.  
 Exposure of materials, 2.2.1.1.  
 Extracted tees, 2.3.3.2.

## F

Ferrous pipe and fittings, 2.2.6.  
 Final tests, 2.3.6.6.  
 Fire protection systems, backflow, 2.6.2.4.  
 Fire separations, 1.4.1.2.[A], 2.2.5.11.  
 Fire service pipes, 1.4.1.2.[A], 2.6.2.4.  
 Fittings  
 90° elbows, 2.2.4.3.  
 ABS, 2.2.5.9.  
 brass or bronze, 2.2.7.2., 2.2.7.3.  
 butt-fusion, 2.2.5.4.  
 cast-iron, 2.2.6.1., 2.2.6.3., 2.2.6.5.  
 cellular core PVC, 2.2.5.16.  
 cleanouts, 2.2.10.3., 2.4.7.1., 2.4.7.4.  
 concrete, 2.2.5.2.  
 corrosion-resistant, 2.2.8.1.  
 couplings, 2.2.6.8., 2.2.10.4., 2.3.2.6.  
 CPVC, 2.2.5.8.  
 cross, 2.2.4.1.  
 crosslinked polyethylene, 2.2.5.6.  
 drainage, 2.5.4.3.  
 drawings for plumbing permit, 2.2.2.1.[C]  
 ferrous, 2.2.6., 2.2.10.3.  
 fibrocement, 2.2.5.1.  
 flanged, 2.2.7.2.  
 flared-joint, 2.2.7.7.  
 increasers, 2.3.3.5.  
 installation of pipe, 2.3.2.1.  
 lead, 2.2.7.8.  
 malleable-iron, 2.2.6.6.

marking, 2.2.1.3.  
 minimum pressure, 2.2.1.5.  
 non-ferrous, 2.2.7.  
 non-metallic, 2.2.5.  
 PE/AL/PE, 2.2.5.12.  
 PE-RT, 2.2.5.15.  
 PEX/AL/PEX, 2.2.5.13.  
 plastic, 2.2.5.9., 2.2.5.11.  
 polyethylene, 2.2.5.4.  
 polypropylene, 2.2.5.14.  
 PVC, 2.2.5.7.  
 reducers, 2.3.3.5.  
 restrictions on use, 2.2.4., 2.2.5.2., 2.2.5.3., 2.2.5.16., 2.2.6.1., 2.2.6.3., 2.2.6.5. - 2.2.6.7., 2.2.7.3. - 2.2.7.5.  
 sanitary T, 2.2.4.2., 2.5.4.5.  
 screwed, 2.2.6.5., 2.2.6.6.  
 solder-joint, 2.2.7.5., 2.2.7.6.  
 stainless steel butt weld, 2.2.6.11.  
 stainless steel threaded, 2.2.6.13.  
 supply and waste, 2.2.10.6.  
 T, 2.2.4.1.  
 used in buildings, 2.2.5.11.  
 used underground, 2.2.5.9.  
 vitrified clay, 2.2.5.3.

Fixture drains  
 cleanouts, 2.4.7.1.  
 connections to circuit vents, 2.5.3.1.  
 connections to wet vents, 2.5.2.1.  
 definition, 1.4.1.2.[A]  
 directly connected, 2.4.2.3.  
 fixture traps, 2.5.6.3.  
 for floor outlet fixtures, 2.3.3.8.  
 indirectly connected, 2.3.3.11.  
 protection from backflow, 2.4.6.4.  
 venting of traps, 2.5.1.1.  
 Fixture outlet pipes  
 as cleanouts, 2.4.7.1.  
 definition, 1.4.1.2.[A]  
 developed length, 1.4.1.2.[A], 2.4.8.2.  
 directly connected, 2.4.2.3.  
 size, 2.4.9.3.  
 Fixtures  
 in chemical storage locations, 2.4.3.4.  
 conformance to standards, 2.2.2.2.  
 connections, 2.3.3.8., 2.4.2.1. - 2.4.2.3.  
 construction, 2.2.2.  
 definition, 1.4.1.2.[A]  
 design, 2.6.1.1.  
 directly connected, 2.4.2.1., 2.4.2.3.  
 draining into vent pipes, 2.5.4.5.  
 hydraulic loads, 2.4.9.3., 2.4.10.2., 2.4.10.3., 2.4.10.12., 2.6.3.2.  
 indirectly connected, 2.3.3.11., 2.4.2.1., 2.4.5.1.  
 installation, 2.1.3.1., 2.3.4.1., 2.3.4.2., 2.4.3., 2.6.1.3.  
 location, 2.1.3.2., 2.4.7.4.  
 maximum water use, 2.6.1.6.  
 provision for future installation, 2.5.5.5.  
 restrictions on re-use, 2.2.1.2.  
 separately vented, 2.5.3.1.  
 size of supply pipe, 2.6.3.2.  
 surface requirements, 2.2.2.1.

trap arms, 2.5.6.3.  
 vent pipes, 2.5.6.4.  
 vent stacks for, 2.5.4.2.

Fixture units  
 conversion to litres, 2.4.10.5.  
 definitions, 1.4.1.2.[A]

Flanges  
 brass floor, 2.2.10.1., 2.3.3.8.  
 brass or bronze pipe, 2.2.7.2.  
 floor, 2.2.10.1., 2.2.10.2., 2.3.3.8.  
 lead, 2.3.2.2.  
 stainless steel pipe, 2.2.6.12.

Flared-joint fittings, 2.2.7.7., 2.3.3.12.

Flared joints, 2.3.2.5.

Flashing, vent pipe, 2.2.10.14., 2.5.6.5.

Flexible water connectors, 2.2.10.18.

Flood level rim, 1.4.1.2.[A]

Floor drains  
 in chemical storage locations, 2.4.3.4.  
 connections to drainage system, 2.4.2.1., 2.4.3.4.  
 emergency, 1.4.1.2.[A], 2.5.2.1.  
 size of outlet pipes, 2.4.9.3.  
 traps, 2.4.5.1., 2.4.5.2., 2.5.1.1.

Floor outlet fixtures, drain connections, 2.3.3.8.

Flow control roof drains, 1.4.1.2.[A], 2.4.10.4.

Flushing devices, 2.2.10.8., 2.6.1.6.

Fluxes, 2.2.9.2.

Food preparation sinks, overflows, 2.2.2.4.

Freezing  
 air admittance valves, 2.5.9.3.  
 protection against, 2.3.5.3.  
 storm drainage systems, 2.4.5.2.  
 test conditions, 2.3.7.1.

Fresh air inlets, 1.4.1.2.[A], 2.5.1.1., 2.5.5.4., 2.5.6.5.

Functional statements  
 application, 3.1.1.2.[A]  
 attribution to acceptable solutions, 2.8.1.1.  
 list of, 3.2.1.1.[A]

## G

Galvanized steel or iron pipe and fittings, 2.2.6.7.,  
 2.3.3.3., 2.3.4.5.

Garbage grinders, 2.4.3.3., 2.4.9.3.

Grease interceptors (see Interceptors)

Groove and shoulder mechanical couplings, 2.2.10.4.,  
 2.3.2.6.

Gutters, roof, 1.4.1.2.[A], 2.4.10.10.

## H

Hangers, pipe, 2.3.4.3., 2.3.4.5., 2.3.4.6.

Healthcare facilities, 2.2.10.6., 2.2.10.7., 2.4.7.4., 2.7.1.1.

Home-type care occupancy, 1.4.1.2.[A]

Horizontal offsets, 1.4.1.2.[A], 2.4.2.1., 2.4.9.5.,  
 2.4.10.6., 2.5.2.1., 2.5.4.4.

Horizontal piping, support, 2.3.4.5., 2.3.4.6.

Hose bibbs, 2.6.2.7., 2.6.3.2.

Hot water systems, 2.2.5.7., 2.2.5.12., 2.2.10.7.,  
 2.2.10.13., 2.4.4.2., 2.6.1.1., 2.6.1.8.

Hot water waste, cooling of, 2.4.4.2.

Hub and spigot pipe, 2.3.2.1.

Hydrants, frost-proof, 2.6.1.4.

Hydraulic loads  
 circuit vents, 2.5.3.1., 2.5.8.3.  
 continuous vents, 2.5.8.3.  
 determination, 2.4.10.  
 sizing of fixture outlet pipes, 2.4.9.3.  
 sizing of water distribution systems, 2.6.3.2.,  
 2.6.3.4.  
 vent stacks, 2.5.8.4.  
 wet vents, 2.5.2.1., 2.5.8.1.

Hydromassage bathtubs, 2.2.2.2.

## I

Iceboxes, 2.4.9.3.

Identification  
 materials and equipment, 2.2.1.3., 2.7.1.2.  
 non-potable water systems, 2.7.1.2.

Increaser fittings, 2.3.3.5.

Indirect connections, 2.3.3.11., 2.4.2.1., 2.4.3.2., 2.4.4.4.,  
 2.7.2.4.

Indirectly connected, 1.4.1.2.[A], 2.3.3.11., 2.4.2.1.,  
 2.4.5.1., 2.4.5.5.

Indirect service water heaters, 1.4.1.2.[A], 2.6.1.7.,  
 2.6.1.12.

Individual vents, 1.4.1.2.[A], 2.5.1.1., 2.5.8.2., 2.5.9.1.

Inlets, fresh air, 1.4.1.2.[A], 2.5.1.1., 2.5.5.4.

Inspection (see Testing)

Installation of fixtures  
 connections, 2.3.3.8., 2.4.2.1.  
 location, 2.1.3., 2.4.3., 2.5.3.1.  
 protection with traps, 2.4.5.1.  
 provision for future, 2.5.5.5.  
 relief valves, 2.6.1.7.  
 shut-off valves, 2.6.1.3.  
 support of piping, 2.3.4.1., 2.3.4.2.

Insulation, electrical, 2.3.4.3.

Interceptors  
 capacity, 2.4.4.3.  
 cleanouts, 2.4.7.1.  
 definition, 1.4.1.2.[A]  
 design, 2.2.3.2.  
 drum traps serving as, 2.2.3.1.  
 gasoline, 2.4.4.3.  
 grease, 2.2.3.2., 2.4.4.3.  
 location, 2.1.3.2.  
 oil, 2.4.4.3., 2.5.5.2.  
 replacing traps, 2.4.5.1.  
 restrictions on use, 2.4.3.3.  
 sand or grit, 2.4.4.3.  
 venting, 2.5.5.2.  
 where required, 2.4.4.3.

**J**

Jointing materials, 2.2.9.  
 Joints, pipe, 2.2.1.5., 2.2.5.2., 2.2.5.3., 2.2.6.4., 2.3.2., 2.3.3.

**L**

Laboratories  
 drainage systems, 2.2.8.1.  
 hazardous waste cleanouts, 2.4.7.4.  
 sizing of water distribution systems, 2.6.3.2.  
 traps for sinks, 2.4.5.1.  
 Laundry trays, 2.2.3.1., 2.4.5.1., 2.4.9.3., 2.7.2.2.  
 Lavatories, 2.2.3.1., 2.2.10.6., 2.4.9.3., 2.6.3.2.  
 Lead content of solders and fluxes, 2.2.9.2.  
 Leaders (downspouts)  
 connections to roof drains, 2.3.3.7.  
 definition, 1.4.1.2.[A]  
 external, exceptions to testing, 2.3.6.1., 2.3.6.2.  
 hydraulic loads, 2.4.10.11.  
 internal, cleanouts, 2.4.7.1.  
 internal, protection from condensation, 2.3.5.5.  
 sheet metal, 2.2.6.9.  
 size, 2.4.9.5.  
 traps, 2.4.5.2.  
 Lead waste pipe and fittings, 2.2.7.8., 2.3.4.5.  
 Lead water-closet bends, 2.2.7.8., 2.4.2.1.  
 Lead water-closet stubs, 2.3.3.8.  
 Lighting of rooms, 2.1.3.1.  
 Loads  
 hydraulic, 2.4.9.3., 2.4.10., 2.5.2.1., 2.5.3.1., 2.5.8.1., 2.5.8.3., 2.6.3.2., 2.6.3.4.  
 from walls, isolation of piping from, 2.3.5.2.

**M**

Macerating toilet systems, 2.2.2.2., 2.4.3.5., 2.4.9.2., 2.4.9.3., 2.5.7.7.  
 Maintenance holes (see Manholes)  
 Malleable-iron water fittings, screwed, 2.2.6.6.  
 Manholes  
 cast-iron frames and covers for, 2.2.6.2.  
 as cleanouts, 2.4.7.1., 2.4.7.3.  
 concrete, 2.2.5.2.  
 design, 2.4.7.3.  
 vent pipes for, 2.5.7.6.  
 Manually operated valves, 2.2.10.6.  
 Marking of pipes and fittings, 2.2.1.3., 2.7.1.2.  
 Materials and equipment  
 characteristics, 1.2.2.1.[A]  
 corrosion-resistant, 2.2.8., 2.2.10.2.  
 defects, 1.2.2.1.[A]  
 dissimilar, 2.3.3.6.  
 exposure, 2.2.1.1.  
 fixtures, 2.2.2.  
 identification, 2.2.1.3., 2.7.1.2.  
 for jointing, 2.2.9.  
 minimum pressure, 2.2.1.5.

miscellaneous, 2.2.10.  
 pipe fittings, 2.2.4.  
 pipe and fittings, ferrous, 2.2.6.  
 pipe and fittings, non-ferrous, 2.2.7.  
 pipe and fittings, non-metallic, 2.2.5.  
 traps and interceptors, 2.2.3.  
 used, 1.2.2.2.[A], 2.2.1.2.  
 Mechanical couplings, 2.2.10.4.  
 Mechanical damage, protection against, 2.3.5.4.  
 Mechanical joints  
 construction and use, 2.3.2.6., 2.3.3.6.  
 pipe couplings, 2.2.10.4.  
 Mobile homes  
 sewer service, 2.4.6.5.  
 water service pipes, 2.6.1.10.  
 Moisture, protection against, 2.3.5.5.  
 Mortar  
 cement, 2.2.9.1.  
 cement lining, 2.2.6.4.  
 Mortuaries  
 autopsy tables, 2.4.9.3.  
 cleanouts, 2.4.7.4.

**N**

Neutralizing tanks for corrosive or acid waste, 2.4.4.4., 2.5.5.3., 2.5.7.7.  
 Nominally horizontal  
 definition, 1.4.1.2.[A]  
 offset, in stacks, 2.4.2.1., 2.4.10.6.  
 pipes, sizing of cleanouts, 2.4.7.2.  
 piping, 2.3.4.5., 2.3.4.6.  
 sanitary drainage pipes, 2.2.4.2., 2.4.2.1., 2.5.2.1.  
 Nominally vertical  
 definition, 1.4.1.2.[A]  
 vent pipes, 2.5.6.2., 2.5.6.5.  
 Noncombustible  
 definition, 1.4.1.2.[A]  
 piping, 2.2.5.11.  
 Non-ferrous pipe and fittings, 2.2.7.  
 Non-metallic pipe and fittings, 2.2.5.  
 Non-potable rainwater harvesting systems  
 design, 2.7.2.4.  
 meaning of terms, 2.7.2.1.  
 permitted applications, 2.7.2.2.  
 protection of potable water system, 2.7.2.4.  
 roof surfaces and components, 2.7.2.3.  
 water collected, restrictions, 2.7.2.4.  
 Non-potable water systems  
 connections to potable water systems, 2.6.2.1., 2.7.1.1.  
 design, 2.7.1.1.  
 identification, 2.7.1.2.  
 location of pipes and outlets, 2.7.1.3., 2.7.1.4.  
 protection of public water system, 2.6.2.5.  
 use, 2.7.1.1.  
 Nuts, 2.2.10.2., 2.2.10.3.

## O

- Objectives
  - application, 2.1.1.2.[A]
  - attribution to acceptable solutions, 2.8.1.1.
  - list of, 2.2.1.1.[A]
- Occupancy, 1.4.1.2.[A]
- Offset relief vents
  - definition, 1.4.1.2.[A]
  - for fixtures draining into vent pipes, 2.5.4.5.
  - protection of drainage system, 2.5.1.1.
  - sizing, 2.5.7.4., 2.5.8.5.
  - for stacks, 2.5.4.4.
  - for traps, 2.5.1.1.
- Offsets (in piping)
  - definition, 1.4.1.2.[A]
  - leaders, 2.4.9.5.
  - stacks, 2.4.2.1., 2.4.10.6., 2.5.4.4.
  - wet vents, 2.5.2.1.
- Oil interceptors (see Interceptors)
- Organizations, 1.3.2., 1.5.2.[A]
- Outlets from non-potable water systems, 2.7.1.2., 2.7.1.4.
- Overflows
  - rainwater storage tanks, 2.4.2.2.
  - roof drain, control, 2.4.10.4.
  - sinks, 2.2.2.4.

## P

- Paved surfaces, hydraulic loads, 2.4.10.1., 2.4.10.4.
- PE/AL/PE (polyethylene/aluminum/polyethylene)
  - pipe and fittings, 2.2.5.12., 2.3.4.5.
- Permits, plumbing, 2.2.2.1.[C]
- Personal hygiene devices, 2.2.2.2.
- PE-RT (polyethylene of raised temperature) tube and fittings, 2.2.5.15., 2.3.4.5.
- PEX/AL/PEX (crosslinked polyethylene/aluminum/cross-linked polyethylene) composite pipe and fittings, 2.2.5.13., 2.3.4.5.
- Pipe
  - ABS, 2.2.5.9., 2.2.5.10., 2.3.4.5.
  - applications, summary, 2.2.5. - 2.2.8.
  - bell and spigot, 2.3.2.7.
  - brass, 2.2.7.1., 2.2.7.2., 2.3.4.2., 2.3.4.5.
  - cast-iron, 2.2.6.1., 2.2.6.4., 2.3.3.3., 2.3.3.8., 2.3.4.5.
  - cellular core PVC, 2.2.5.16.
  - combustible, 2.2.5.11.
  - concrete, 2.2.5.2.
  - copper, 2.2.7.1., 2.3.2.1., 2.3.4.3., 2.3.4.5.
  - corrosion-resistant, 2.2.8.
  - corrugated steel, 2.2.6.8.
  - CPVC, 2.2.5.8., 2.3.4.5.
  - crosslinked polyethylene, 2.2.5.6.
  - ductile-iron water, 2.2.6.4.
  - ferrous, 2.2.6.
  - fibrocement, 2.2.5.1.
  - hangers, 2.3.4.3., 2.3.4.5., 2.3.4.6.
  - hub and spigot, 2.3.2.1.
  - hydraulic loads, 2.4.10.1.

- joints and connections, 2.3.2., 2.3.3.
        - lead, 2.2.7.8., 2.3.4.5.
        - leaders, 1.4.1.2.[A], 2.2.6.9., 2.3.5.5., 2.4.7.1., 2.4.9.5., 2.4.10.11.
        - marking, 2.2.1.3., 2.7.1.2.
        - noncombustible, 2.2.5.11.
        - non-ferrous, 2.2.7.
        - non-metallic, 2.2.5.
        - open ended, 2.4.6.1.
        - PE/AL/PE, 2.2.5.12., 2.3.4.5.
        - PEX/AL/PEX, 2.2.5.13., 2.3.4.5.
        - plastic, 2.2.5.9., 2.2.5.11., 2.3.3.8., 2.3.4.5.
        - polyethylene, 2.2.5.4., 2.2.5.5.
        - polypropylene, 2.2.5.14.
        - protection, 2.3.5., 2.6.1.4.
        - PVC, 2.2.5.7., 2.3.4.5.
        - size, 2.4.9.
        - steel, 2.2.6.7., 2.2.6.8., 2.2.6.10., 2.2.6.15., 2.3.3.3., 2.3.4.5.
        - subsoil drainage, 2.4.5.3., 2.4.6.4.
        - underground, 2.3.4.6., 2.3.5.1.
        - vitrified clay, 2.2.5.3.
        - water service, 1.4.1.2.[A], 2.2.1.6., 2.6.1.3., 2.6.1.5., 2.6.1.10., 2.6.3.4.
- Pipe fittings (see Fittings)
- Pipe flanges
  - brass or bronze, 2.2.7.2.
  - stainless steel, 2.2.6.12.
- Piping
  - combustible, 1.4.1.2.[A], 2.2.5.11.
  - construction and use of joints, 2.3.2.
  - contraction accommodation, 2.3.3.9.
  - CPVC design temperature and pressure, 2.2.5.8.
  - drainage, 2.4.6.
  - expansion accommodation, 2.3.3.9.
  - horizontal, 2.3.4.5., 2.3.4.6.
  - installation, 2.3.5.2.
  - joints and connections, 2.3.3.
  - minimum pressure, 2.2.1.5.
  - noncombustible, 1.4.1.2.[A], 2.2.5.11.
  - protection, 2.3.5.
  - service, 2.1.2.4.
  - support, 2.3.4.
  - vertical, 2.3.4.4.
- Plastic fixtures, 2.2.2.2.
- Plastic pipe and fittings, 2.2.5.9., 2.2.5.11.
- Plumbing drawings and related documents, 2.2.2.1.[C]
- Plumbing facilities, 1.1.1.1.[A]
- Plumbing permits, drawing requirements, 2.2.2.1.[C]
- Plumbing systems
  - application of Code, 1.1.1.1.[A]
  - definition, 1.4.1.2.[A]
- Polyethylene/aluminum/polyethylene (PE/AL/PE)
  - pipe and fittings, 2.2.5.12., 2.3.4.5.
- Polyethylene pipe and fittings, 2.2.5.4., 2.2.5.5., 2.3.4.5.
- Polyethylene water pipe, 2.2.5.4.
- Polypropylene pipe and fittings, 2.2.5.14., 2.3.4.5.
- Polyvinyl chloride (PVC) pipe and fittings, 2.2.5.7., 2.3.4.5.
- Porcelain-enamelled fixtures, 2.2.2.2.

Potable, definition, 1.4.1.2.[A]  
 Potable water systems (see also Water distribution systems; Water service pipes; Water systems; Water temperature control; Water treatment devices)  
   arrangement of piping, 2.4.6.2., 2.6.1.  
   cleaning before use, 2.6.2.8.  
   connections, 2.1.2.3., 2.6.2.1., 2.7.1.1.  
   design, fabrication and installation, 2.6.1.1., 2.6.3.1.  
   drainage, 2.6.1.2.  
   drawings for plumbing permit, 2.2.2.1.[C]  
   lead content, restrictions on use, 2.2.9.2.  
   protection from contamination, 2.6.2., 2.7.2.4.  
   size and capacity of pipes, 2.6.3.  
   solar heating, 2.2.10.13., 2.6.1.8.  
   testing, 2.3.7.  
 Potato peelers, 2.4.3.3., 2.4.9.3.  
 Premise isolation, 2.6.2.6.  
 Pressure (see also Back pressure)  
   CPVC piping, 2.2.5.8.  
   PE/AL/PE piping in hot water systems, 2.2.5.12.  
   piping, fittings and joints, 2.2.1.5.  
   PVC piping, 2.2.5.7.  
   static, at fixtures, 2.6.3.3., 2.7.1.1., 2.7.2.4.  
   from suds, 2.4.2.1.  
   testing, 2.3.6.4., 2.3.7.  
   water service pipe, 2.2.1.6., 2.6.3.4.  
 Pressure-reducing valves, 2.2.10.12., 2.6.1.11., 2.6.3.3., 2.7.1.1., 2.7.2.4.  
 Pressure-relief valves, 2.2.10.11., 2.6.1.7.  
 Pressure vacuum breaker, 2.6.2.2., 2.6.2.10.  
 Private sewage disposal systems, 1.4.1.2.[A], 2.1.2.1., 2.4.4.1.  
 Private use, 1.4.1.2.[A], 2.6.3.2., 2.6.3.4.  
 Private water supply system, 1.4.1.2.[A], 2.1.2.3., 2.6.2.5.  
 Protection of piping, 2.3.5.  
 Public use, 1.4.1.2.[A], 2.2.2.5., 2.6.3.2.  
 Public washrooms, 2.2.2.5., 2.2.10.6.  
 Pumps for sumps, 2.4.6.3.  
 PVC (polyvinyl chloride) pipe and fittings, 2.2.5.7., 2.3.4.5.

## R

Rainfall, and hydraulic load, 2.4.10.4.  
 Rainwater harvesting systems, 2.7.2.  
 Rainwater tanks, overflows, 2.4.2.2., 2.7.2.4.  
 Receiving tanks, 2.4.6.3.  
 Reducer fittings, 2.3.3.5.  
 Reducing valves, 2.2.10.12., 2.6.1.11.  
 Referenced documents, 1.3.1., 1.5.1.[A]  
 Relief valves, 2.2.10.11., 2.6.1.7.  
 Relief vents  
   connections, 2.5.3.1., 2.5.6.4., 2.5.7.3.  
   definition, 1.4.1.2.[A]  
   offset, 1.4.1.2.[A], 2.5.1.1., 2.5.4.4., 2.5.4.5., 2.5.7.4., 2.5.8.5.  
   sizing, 2.5.7.3., 2.5.8.5.  
   for traps, 2.5.1.1.

Residential full flow-through fire sprinkler/standpipe system, 1.4.1.2.[A], 2.6.2.4.  
 Residential partial flow-through fire sprinkler/standpipe system, 1.4.1.2.[A], 2.6.2.4.  
 Risers  
   definition, 1.4.1.2.[A]  
   shut-off valves, 2.6.1.3.  
 Roof drains  
   connections to leaders, 2.3.3.7.  
   definition, 1.4.1.2.[A]  
   flow control, 1.4.1.2.[A], 2.4.10.4.  
 Roof gutters, 1.4.1.2.[A], 2.4.10.10.  
 Roofs, hydraulic load from, 2.4.10.4.  
 Rubber gasket joints, 2.2.5.2., 2.2.6.4.

## S

Saddle hubs or fittings, 2.2.10.5.  
 Sanitary building drains (see also Building drains)  
   definition, 1.4.1.2.[A]  
 Sanitary building sewers (see also Building sewers)  
   definition, 1.4.1.2.[A]  
 Sanitary drainage pipes  
   connections, 2.4.2.1., 2.5.6.2.  
   definition, 1.4.1.2.[A]  
   drawings for plumbing permit, 2.2.2.1.[C]  
   hydraulic loads, 2.4.10.6.  
   lead, 2.2.7.8., 2.3.4.5.  
   location, 2.4.6.2.  
   restrictions on use, 2.4.6.1.  
   sizing, 2.4.9.1.  
   vents, serving as, 2.5.2.1., 2.5.3.1., 2.5.7.3.  
 Sanitary drainage systems, 1.4.1.2.[A], 2.4.4.1., 2.4.4.4., 2.4.5.1., 2.4.7.1.  
   connections, 2.1.2.1., 2.4.2.1., 2.4.5.3.  
 Sanitary sewers, 1.4.1.2.[A], 2.1.2.1., 2.5.4.5.  
 Sanitary T fittings, 2.2.4.2.  
 Scope of Code, 1.3.1.[A]  
 Screwed cast-iron water fittings, 2.2.6.5.  
 Screwed joints, 2.3.2.3.  
 Screwed malleable-iron water fittings, 2.2.6.6.  
 Screws, 2.2.10.2.  
 Service water heaters, 1.4.1.2.[A], 2.6.1.7., 2.6.1.12.  
 Sewage  
   cooling of, 2.4.4.2.  
   definition, 1.4.1.2.[A]  
   including corrosive or acid waste, 2.4.4.4., 2.5.5.3.  
   including fats, oils or grease, 2.4.4.3.  
   including oil or gasoline, 2.4.4.3.  
   including sand or grit, 2.4.4.3.  
   received by sumps or tanks, 2.4.6.3., 2.5.5.1., 2.5.8.5.  
   treatment, 2.4.4.1.  
 Sewage disposal system, private, 1.4.1.2.[A], 2.1.2.1., 2.4.4.1.  
 Sewage sumps, venting, 2.5.5.1., 2.5.7.7.  
 Sewers (see Building sewers)  
 Sheet metal leaders, 2.2.6.9.  
 Showers and shower heads  
   construction and arrangement, 2.2.2.3.

- hydraulic loads, 2.6.3.2.
  - size of fixture outlet pipes, 2.4.9.3.
  - sizing of water distribution systems, 2.6.3.2.
  - temperature control, 2.2.10.7.
  - traps, 2.4.5.1.
  - water flow rates, 2.2.10.6.
  - Shut-off valves, 2.4.6.3., 2.6.1.3., 2.6.1.7.
  - Sinks
    - dishwashing and food preparation, 2.2.2.4.
    - floor-mounted service, 2.2.3.1.
    - hot water temperature, 2.2.10.7.
    - size of outlet pipes, 2.4.9.3.
    - sizing of water distribution systems, 2.6.3.2.
    - traps, 2.2.3.1., 2.4.5.1.
  - Size
    - ball, for test, 2.3.6.7.
    - building drains, 2.4.9.4.
    - building sewers, 2.4.9.4.
    - cleanouts, 2.4.7.2.
    - definition, 1.4.1.2.[A]
    - drainage pipes, 2.4.9.
    - fixture outlet pipes, 2.4.8.2., 2.4.9.3.
    - leaders, 2.4.9.5.
    - traps and trap arms, 2.5.1.1., 2.5.6.3.
    - vent pipes, 2.5.4.4., 2.5.5.2., 2.5.7., 2.5.8.
    - water distribution systems, 2.6.3.2.
    - water service pipes, 2.6.3.4.
    - water supply pipes, 2.6.1.7., 2.6.3.
  - Slip joints, 2.3.3.4.
  - Slope of drainage pipes, 2.4.8.1.
  - Soil pipe, cast-iron, 2.2.6.1., 2.3.3.3., 2.3.4.5.
  - Solar domestic hot water systems, 2.2.10.13., 2.6.1.8.
  - Soldered joints, 2.2.9.2., 2.3.2.4.
  - Solder-joint fittings, 2.2.7.5., 2.2.7.6., 2.2.9.2.
  - Solders, 2.2.9.2.
  - Solvent cement, 2.2.5.7., 2.2.5.9. - 2.2.5.11.
  - Sprinkler/standpipe systems, 1.4.1.2.[A], 2.6.2.4., 2.6.3.1.
  - Stacks
    - cleanouts, 2.4.7.1.
    - connections, 2.4.2.1., 2.5.4.2., 2.5.4.3.
    - definition, 1.4.1.2.[A]
    - hydraulic loads, 2.4.10.6.
    - size, 2.4.9.2.
    - vent pipes, 2.5.4.
  - Stack vents
    - definition, 1.4.1.2.[A]
    - length, 2.5.8.4.
    - protection of drainage systems, 2.5.1.1.
    - size, 2.5.7.2., 2.5.8.4.
    - for stacks, 2.5.4.1.
  - Stainless steel butt weld pipe fittings, 2.2.6.11.
  - Stainless steel fixtures, 2.2.2.2.
  - Stainless steel pipe, 2.2.6.10., 2.2.6.15., 2.3.4.3., 2.3.4.5.
  - Stainless steel pipe flanges, 2.2.6.12.
  - Stainless steel threaded fittings, 2.2.6.13.
  - Stainless steel tube, 2.2.6.14., 2.2.6.15., 2.3.4.5.
  - Stainless steel welded joints, 2.3.2.8.
  - Standpipe system, 2.6.2.4.
  - Static pressure, 2.6.3.3., 2.7.1.1., 2.7.2.4.
  - Steel pipe
    - corrugated, 2.2.6.8.
    - galvanized, 2.2.6.7., 2.3.3.3., 2.3.4.5.
    - stainless, 2.2.6.10., 2.2.6.15., 2.3.4.5.
    - welded and seamless, 2.2.6.7.
  - Stop-and-waste cocks, 2.6.1.4.
  - Storage-type service water heaters, 1.4.1.2.[A], 2.6.1.7., 2.6.1.12.
  - Storey, definition, 1.4.1.2.[A]
  - Storm building drains (see also Building drains), 1.4.1.2.[A], 2.4.5.2., 2.4.10.9.
  - Storm building sewers (see also Building sewers), 1.4.1.2.[A], 2.4.5.2., 2.4.10.9.
  - Storm drainage systems
    - cleanouts, 2.4.7.1.
    - connections, 2.1.2.2., 2.4.2.1.
    - definition, 1.4.1.2.[A]
    - location, 2.4.5.2.
    - traps, 2.4.5.2.
  - Storm sewers, 1.4.1.2.[A], 2.1.2.2., 2.4.10.13.
  - Storm water, 1.4.1.2.[A], 2.1.2.2., 2.4.2.1., 2.4.6.1., 2.5.6.5., 2.7.2.
  - Stubs, lead, water closet, 2.3.3.8., 2.4.2.1.
  - Subsoil drainage pipes
    - connections, 2.4.5.3., 2.4.6.4.
    - definition, 1.4.1.2.[A]
    - sumps, 2.4.6.3.
  - Suds pressure zones, 2.4.2.1.
  - Suites, 1.4.1.2.[A], 2.6.1.3.
  - Sumps
    - arrangement of drainage piping, 2.4.6.3.
    - elevator pits, 2.4.3.6.
    - venting, 2.5.5.1., 2.5.7.7.
  - Supply and waste fittings, 2.2.10.6.
  - Supports for piping, 2.3.4.
  - Symbols, 1.4.2.1.[A]
  - Systems, characteristics, 1.2.2.1.[A]
- ## T
- Tanks (drainage), 2.4.6.3.
  - Tank-type water closets, 2.6.2.11.
  - Tee joints, extracted, 2.3.3.2.
  - Temperature controls, 2.2.10.7., 2.6.1.7., 2.6.1.12.
  - Temperature-relief valves
    - specifications, 2.2.10.11.
    - where required, 2.6.1.7.
  - Terminals, vent pipes, 2.5.6.5., 2.5.9.1.
  - Testing
    - drainage and venting systems, 2.3.6.
    - in freezing conditions, 2.3.7.1.
    - potable water systems, 2.3.7.
  - T fittings, 2.2.4.1., 2.2.4.2.
  - Thermal expansion of piping, 2.3.3.9., 2.6.1.11.
  - Threaded cast-iron drainage fittings, 2.2.6.3.
  - Transition solvent cement, 2.2.5.10.
  - Trap arms, 1.4.1.2.[A], 2.3.4.5., 2.5.2.1., 2.5.4.5., 2.5.6.3.
  - Trap dips, 1.4.1.2.[A], 2.4.7.1.
  - Traps
    - bell, 2.2.3.1.



cleanouts, 2.2.3.1., 2.4.5.4., 2.4.7.1.  
 connections, 2.2.3.1.  
 definition, 1.4.1.2.[A]  
 design, 2.2.3.1.  
 drawings for plumbing permit, 2.2.2.1.[C]  
 drum, 2.2.3.1.  
 for fixtures, 2.4.5.1.  
 for floor drains, 2.4.5.2.  
 interceptors, used as, 2.2.3.1., 2.4.5.1.  
 location, 2.4.5.2., 2.4.5.4.  
 materials, 2.2.3.1.  
 restricted locations, 2.4.3.2.  
 for sanitary drainage systems, 2.4.4.4., 2.4.5.1.  
 seals, 2.4.5.5.  
 size, 2.4.10.2., 2.4.10.12., 2.5.7.1.  
 for storm drainage systems, 2.4.5.2.  
 for subsoil drains, 2.4.5.3.  
 tubular, 2.2.3.3.  
 venting, 2.5.1., 2.5.6.3.  
 Trap seal depth, 1.4.1.2.[A], 2.2.3.1.  
 Trap seals  
   maintaining, 2.4.5.5.  
   size, 2.2.3.1.  
 Trap standards  
   definition, 1.4.1.2.[A]  
   installation, 2.3.2.1., 2.3.3.8.  
   trap arms, 2.5.6.3.  
 Trap weirs, 1.4.1.2.[A], 2.3.3.4., 2.4.9.3.  
 Treatment occupancy (see Care, treatment or detention occupancy)  
 Treatment of sewage and wastes, 2.4.4.  
 Trenchless technology, 2.2.5.5.  
 Tube  
   copper, 2.2.7.4., 2.3.3.2., 2.3.3.10., 2.3.4.3., 2.3.4.5.  
   PE-RT, 2.2.5.15., 2.3.4.5.  
   stainless steel, 2.2.6.14., 2.2.6.15., 2.3.4.5.  
 Tubing (see Piping)

## U

Underground pipes  
   copper joints, 2.3.3.12.  
   protection, 2.3.5.1.  
   support, 2.3.4.6.  
 Unions, 2.3.3.4., 2.4.6.3.  
 Urinals  
   connections, 2.3.3.8.  
   flushing devices, 2.6.1.6.  
   hydraulic loads, 2.6.3.2.  
   location, 2.4.3.1.  
   size of fixture outlet pipes, 2.4.9.3.  
 Used materials and equipment, 1.2.2.2.[A], 2.2.1.2.

## V

Vacuum breakers (see also Back-siphonage preventers), 2.2.10.8., 2.6.2.2., 2.6.2.10.  
 Vacuum-relief valves, 2.2.10.11., 2.6.1.7.

Valves  
   accessibility, 2.1.3.2.  
   air admittance, 1.4.1.2.[A], 2.2.10.16., 2.5.9.  
   automatic compensating, 2.2.10.6., 2.2.10.7.  
   backflow preventers, 1.4.1.2.[A], 2.2.10.10., 2.6.1.11., 2.6.2.1., 2.6.2.2., 2.6.2.12., 2.7.2.4.  
   backwater, 1.4.1.2.[A], 2.4.2.1., 2.4.3.6., 2.4.6.3., 2.4.6.4., 2.7.2.4.  
   check, 1.4.1.2.[A], 2.4.2.1., 2.4.6.3., 2.6.1.5., 2.6.1.11., 2.6.2.2. - 2.6.2.4.  
   direct flush, 2.2.10.8., 2.4.9.3.  
   manually operated, 2.2.10.6.  
   pressure-reducing, 2.6.1.11., 2.6.3.3., 2.7.1.1., 2.7.2.4.  
   pressure-relief, 2.2.10.11., 2.6.1.7.  
   reducing, 2.2.10.12.  
   shut-off, 2.4.6.3., 2.6.1.3., 2.6.1.7.  
   temperature-relief, 2.2.10.11., 2.6.1.7.  
   vacuum-relief, 2.2.10.11., 2.6.1.7.  
 Velocity, water service pipes, 2.6.3.5.  
 Vent headers, 1.4.1.2.[A], 2.5.1.1., 2.5.7.2., 2.5.8.3.  
 Ventilation of rooms, 2.1.3.1.  
 Venting  
   circuit, 2.5.3.  
   corrosive drain piping, 2.5.5.3.  
   dilution tanks, 2.5.5.3., 2.5.7.7.  
   floor drains, 2.5.1.1.  
   interceptors, 2.5.5.2.  
   neutralizing tanks, 2.5.5.3., 2.5.7.7.  
   sewage sumps, 2.5.5.1.  
   wet, 2.5.2., 2.5.8.1.  
 Venting systems  
   definition, 1.4.1.2.[A]  
   design and installation, 2.5.  
   piping and materials, 2.2.4. - 2.2.6., 2.2.7.4., 2.2.8.1., 2.2.10., 2.3.2.1., 2.3.2.7., 2.3.3.4.  
   provision for future installation, 2.5.5.5.  
   testing, 2.3.6.  
 Vent pipes  
   arrangement, 2.5.6.  
   cast-iron, 2.2.6.1.  
   connections, 2.5.6.2.  
   definition, 1.4.1.2.[A]  
   for dilution tanks, 2.5.5.3., 2.5.7.7.  
   drainage, 2.5.6.1.  
   drawings for plumbing permit, 2.2.2.1.[C]  
   flashing, 2.2.10.14.  
   location, 2.5.6.3.  
   for macerating toilets, 2.5.7.7.  
   for manholes, 2.5.7.6.  
   miscellaneous, 2.5.5.  
   neutralizing tanks, 2.5.5.3., 2.5.7.7.  
   for sewage sumps, 2.5.7.7.  
   sizing, 2.5.7., 2.5.8.  
   for stacks, 2.5.4.  
   suds pressure zones, 2.4.2.1.  
   support above roof, 2.3.4.7.  
   terminals, 2.5.6.5.  
   for traps, 2.5.1.  
 Vents  
   additional circuit, 1.4.1.2.[A], 2.5.1.1., 2.5.3.1., 2.5.4.5., 2.5.7.3., 2.5.8.5.

branch, 1.4.1.2.[A], 2.5.1.1., 2.5.7.2., 2.5.8.3.  
circuit, 1.4.1.2.[A], 2.5.1.1., 2.5.3.1., 2.5.4.5., 2.5.7.3., 2.5.8.3.  
continuous, 1.4.1.2.[A], 2.5.1.1., 2.5.2.1., 2.5.8.3.  
dual, 1.4.1.2.[A], 2.5.1.1., 2.5.8.2., 2.5.9.1.  
individual, 1.4.1.2.[A], 2.5.1.1., 2.5.8.2., 2.5.8.3., 2.5.9.1.  
offset relief, 1.4.1.2.[A], 2.5.1.1., 2.5.4.4., 2.5.4.5., 2.5.7.4., 2.5.8.5.  
relief, 1.4.1.2.[A], 2.5.1.1., 2.5.3.1., 2.5.6.4., 2.5.7.3., 2.5.8.5.  
stack, 1.4.1.2.[A], 2.5.1.1., 2.5.4.1., 2.5.7.2., 2.5.8.4.  
wet, 1.4.1.2.[A], 2.5.1.1., 2.5.2.1., 2.5.8.1.  
yoke, 1.4.1.2.[A], 2.5.1.1., 2.5.4.3., 2.5.4.5., 2.5.7.5., 2.5.8.5.

Vent stacks  
definition, 1.4.1.2.[A]  
sizing, 2.5.7.2., 2.5.8.4.  
for stacks, 2.5.4.2.  
for traps, 2.5.1.

Vertical piping, support, 2.3.4.4.

Vitreous china fixtures, 2.2.2.2.

Vitrified clay pipe and fittings, 2.2.5.3.

## W

Washers, 2.2.10.2., 2.4.9.3., 2.6.3.2., 2.7.2.2.

Washing machines, 2.4.5.1., 2.4.9.3., 2.6.3.2.

Waste, cooling, 2.4.4.2.

Waste pipes (see Sanitary drainage pipes)

Water closets  
connections, 2.3.3.8.  
flushing devices, 2.6.1.6.  
hydraulic loads, 2.6.3.2.  
in public washrooms, 2.2.2.5.  
screws, bolts, nuts and washers, 2.2.10.2.  
size of pipes serving, 2.4.9.2., 2.4.9.3.  
tank-type, 2.2.10.10., 2.6.2.11.  
trap arms, 2.5.6.3.

Water coolers, 2.6.3.2.

Water distribution systems  
connection, 2.1.2.3.  
definition, 1.4.1.2.[A]  
design and installation, 2.6.1.1., 2.6.1.2.  
materials, 2.2.6.7., 2.2.6.15., 2.2.7.4.  
protection, 2.6.1.9.

Water flow rates, 2.2.10.6.

Water hammer arresters, 2.2.10.15.

Water hammer, prevention, 2.6.1.9.

Water heaters  
indirect service, 1.4.1.2.[A]  
pressure-relief valve, 2.6.1.7.  
storage-type, 1.4.1.2.[A]  
temperature controls, 2.6.1.7., 2.6.1.12.

Water pipes  
cast-iron, 2.2.6.4.  
CPVC, 2.2.5.8.  
polyethylene, 2.2.5.4.  
PVC, 2.2.5.7.  
size and capacity, 2.6.3.

Water pressure tests, 2.3.6.1. - 2.3.6.4., 2.3.7.1. - 2.3.7.3.

Water service pipes  
definition, 1.4.1.2.[A]  
mobile home, 2.6.1.10.  
sizing, 2.6.3.4.  
velocity, 2.6.3.5.  
working pressure, 2.2.1.6.

Water supply  
auxiliary, 1.4.1.2.[A]  
design, fabrication and installation, 2.6.3.1.  
private, 1.4.1.2.[A], 2.6.2.5.  
protection, 2.6.1.4.  
separation of public and private systems, 2.6.2.5.

Water systems (see also Non-potable water systems)  
definition, 1.4.1.2.[A]

Water temperature control, 2.2.10.7.

Water treatment devices, 2.2.10.17., 2.6.2.1.

Water usage per flush cycle, 2.6.1.6.

Welded joints  
restrictions on use, 2.3.3.3.  
stainless steel, 2.3.2.8.

Welded and seamless steel pipe, 2.2.6.7.

Wet venting, 2.5.2., 2.5.8.1.

Wet vents, 1.4.1.2.[A], 2.5.1.1., 2.5.2.1., 2.5.8.1.

Wiped joints, 2.3.2.2.

## Y

Yoke vents  
definition, 1.4.1.2.[A]  
for fixtures draining into vent pipes, 2.5.4.5.  
sizing, 2.5.7.5., 2.5.8.5.  
for stacks, 2.5.4.3.  
for traps, 2.5.1.1.

## Z

Zinc, alloyed, 1.4.1.2.[A], 2.2.10.14.

## Symbols and Abbreviations

The following symbols and abbreviations are used in the figures:

Water and drainage pipe \_\_\_\_\_

Subsoil drains \_ \_ \_ \_ \_

Vent pipe \_ \_ \_ \_ \_

BG	Bathroom group	KS	Kitchen sink
BT	Bathtub	LAV	Lavatory
CO	Cleanout	LT	Laundry tray
CW	Clothes washer	RD	Roof drain
DF	Drinking fountain	SHWR	Shower
DW	Dishwasher	SS	Slop sink
FD	Floor drain	SWH	Service water heater
FS	Floor sink	UR	Urinals
HB	Hose bibb	WC	Water closet

## Conversion Factors

To Convert	To	Multiply by
°C	°F	1.8 and add 32
kg	lb.	2.205
kg/m <sup>3</sup>	lb/ft. <sup>3</sup>	0.06243
kN	lb.	224.81
kN/m	lb/ft.	68.52
kN/m <sup>3</sup>	lb/ft. <sup>3</sup>	6.360
kPa	lb/in. <sup>2</sup> (psi)	0.1450
kPa	lb/ft. <sup>2</sup>	20.88
L	gal. (imp.)	0.2200
L/s	gal./min (gpm)	13.20
m	ft.	3.281
m <sup>2</sup>	ft. <sup>2</sup>	10.76
mm	in.	0.03937
m/s <sup>2</sup>	ft./s <sup>2</sup>	3.281

**Nominal Pipe Size (NPS) to Diameter Nominal (DN)  
Conversion Chart**

<b>NPS, in.</b>	<b>DN, mm</b>
1/8	6
1/4	8
3/8	10
1/2	15
3/4	20
1	25
1 1/4	32
1 1/2	38
2	50
2 1/2	65
3	75
4	100
5	125
6	150
8	200
10	250
12	300
14	350
16	400
18	450
20	500
22	550
24	600