

---

# **Model National Energy Code of Canada for Buildings 1997**

**Issued by the  
Canadian Commission on Building and Fire Codes  
National Research Council of Canada**

---

First Edition 1997

ISBN 0-660-16897-9

© National Research Council of Canada  
Ottawa  
World Rights Reserved  
NRCC 38731

Printed in Canada

Aussi disponible en français :  
Code modèle national de l'énergie pour les bâtiments – Canada 1997

# Table of Contents

<b>Preface</b> .....	v	<b>3.3.1.</b>	<b>Above-ground Components of the Building Envelope</b> .....	20
<b>A Guide to the Use of this Code</b> .....	ix	<b>3.3.2.</b>	<b>Special Interior Temperature Conditions</b> .....	21
<b>Canadian Commission on Building and Fire Codes and Standing Committees</b> .....	xi	<b>3.4.</b>	<b>Trade-offs</b> .....	22
<b>Part 1 Scope and Definitions</b>		<b>3.4.1.</b>	<b>General</b> .....	22
<b>1.1. General</b> .....	1	<b>3.4.2.</b>	<b>Simple Trade-offs</b> .....	22
<b>1.1.1. Administration</b> .....	1	<b>3.4.3.</b>	<b>Computer-assisted Trade-offs</b> ...	22
<b>1.1.2. Scope</b> .....	1	<b>3.5.</b>	<b>Building Energy Performance Compliance</b> .....	23
<b>1.1.3. Definitions of Words and Phrases</b> .....	1	<b>3.5.1.</b>	<b>Alternate Compliance Path</b> .....	23
<b>1.1.4. Abbreviations</b> .....	5	<b>Part 4 Lighting</b>		
<b>Part 2 General Requirements</b>		<b>4.1. General</b> .....	<b>25</b>	
<b>2.1. General</b> .....	9	<b>4.1.1. Scope</b> .....	<b>25</b>	
<b>2.1.1. Compliance</b> .....	9	<b>4.2. Mandatory Provisions</b> .....	<b>25</b>	
<b>2.2. Basic Data and Calculation Methods</b> .....	9	<b>4.2.1. Exterior Lighting Power</b> .....	<b>25</b>	
<b>2.2.1. Climatic Data</b> .....	9	<b>4.2.2. Exterior Lighting Controls</b> .....	<b>26</b>	
<b>2.2.2. Calculation Procedures</b> .....	9	<b>4.2.3. Interior Lighting Power</b> .....	<b>26</b>	
<b>2.3. Documentation</b> .....	11	<b>4.2.4. Interior Lighting Controls</b> .....	<b>26</b>	
<b>2.3.1. General</b> .....	11	<b>4.2.5. Ballasts</b> .....	<b>27</b>	
<b>2.4. Materials, Appliances, Systems and Equipment</b> .....	11	<b>4.2.6. Documentation</b> .....	<b>27</b>	
<b>2.4.1. General</b> .....	11	<b>4.3. Prescriptive Compliance</b> .....	<b>27</b>	
<b>2.5. Equivalents</b> .....	11	<b>4.3.1. Interior Connected Lighting Power</b> .....	<b>27</b>	
<b>2.5.1. General</b> .....	11	<b>4.3.2. Calculation of Interior Lighting Power Allowance by Building Type</b> .....	<b>28</b>	
<b>2.6. Referenced Documents</b> .....	12	<b>4.3.3. Calculation of Interior Lighting Power Allowance by Space Function</b> .....	<b>30</b>	
<b>2.6.1. Application</b> .....	12	<b>4.4. Building Energy Performance Compliance</b> .....	<b>33</b>	
<b>Part 3 Building Envelope</b>		<b>4.4.1. Alternate Compliance Path</b> .....	<b>33</b>	
<b>3.1. General</b> .....	17	<b>Part 5 Heating, Ventilating and Air-conditioning Systems</b>		
<b>3.1.1. Scope</b> .....	17	<b>5.1. General</b> .....	<b>35</b>	
<b>3.2. Mandatory Provisions</b> .....	17	<b>5.1.1. Scope</b> .....	<b>35</b>	
<b>3.2.1. General</b> .....	17	<b>5.2. Mandatory Provisions</b> .....	<b>35</b>	
<b>3.2.2. Above-ground Components of the Building Envelope</b> .....	18	<b>5.2.1. Equipment Sizing</b> .....	<b>35</b>	
<b>3.2.3. Building Assemblies in Contact with the Ground</b> .....	19	<b>5.2.2. Air Distribution Systems</b> .....	<b>35</b>	
<b>3.2.4. Airtightness</b> .....	19	<b>5.2.3. Air Intake and Outlet Dampers</b> ..	<b>37</b>	
<b>3.3. Prescriptive Compliance</b> .....	20	<b>5.2.4. Piping for Heating and Cooling Systems</b> .....	<b>37</b>	
		<b>5.2.5. Pumping System Design</b> .....	<b>38</b>	

5.2.6.	Equipment Installed Outdoors ...	38	8.2.	Performance Compliance .....	57
5.2.7.	Electric Heating Systems .....	38	8.2.1.	Compliance .....	57
5.2.8.	Recessed Heaters .....	39			
5.2.9.	Air Distribution Systems Serving Spaces with Special Requirements .....	39	<b>Appendix A</b>	<b>Regional Requirements.....</b>	<b>59</b>
5.2.10.	Temperature Controls .....	39	<b>Appendix B</b>	<b>Thermal Characteristics of Common Building Assemblies.....</b>	<b>131</b>
5.2.11.	Humidification .....	40			
5.2.12.	Shutoff and Setback .....	40	<b>Appendix C</b>	<b>Method for Calculating the Thermal Properties of Building Assemblies...</b>	<b>175</b>
5.2.13.	Equipment Efficiency .....	41			
5.2.14.	Documentation .....	44	<b>Appendix D</b>	<b>Energy Source Adjustment Factors....</b>	<b>193</b>
5.3.	Prescriptive Compliance .....	45	<b>Appendix E</b>	<b>Commentary .....</b>	<b>195</b>
5.3.1.	Fan System Design .....	45	<b>Appendix F</b>	<b>Determination of Regionally Sensitive Requirements.....</b>	<b>219</b>
5.3.2.	Cooling with Outdoor Air .....	45			
5.3.3.	Control of Heating, Ventilating and Air-conditioning Systems ....	46	<b>Appendix G</b>	<b>Conversion Factors.....</b>	<b>225</b>
5.3.4.	Heat Recovery .....	46			
5.4.	Building Energy Performance Compliance .....	47			
5.4.1.	Alternate Compliance Path .....	47			
<b>Part 6</b>	<b>Service Water Heating Systems</b>				
6.1.	General .....	49			
6.1.1.	Scope .....	49			
6.2.	Mandatory Provisions .....	49			
6.2.1.	System Design .....	49			
6.2.2.	Storage Vessels and Heating Equipment .....	49			
6.2.3.	Piping .....	51			
6.2.4.	Controls .....	52			
6.2.5.	Systems with More Than One End Use Design Temperature ....	52			
6.2.6.	Conservation of Hot Water .....	53			
6.2.7.	Swimming Pools .....	53			
6.3.	Prescriptive Compliance .....	53			
6.3.1.	Combination Equipment .....	53			
6.4.	Building Energy Performance Compliance .....	53			
6.4.1.	Alternate Compliance Path .....	53			
<b>Part 7</b>	<b>Electrical Power</b>				
7.1.	General .....	55			
7.1.1.	Scope .....	55			
7.2.	Mandatory Provisions .....	55			
7.2.1.	Electrical Distribution System ...	55			
7.2.2.	Power Controls .....	56			
7.2.3.	Transformers .....	56			
7.2.4.	Electrical Motors .....	56			
7.2.5.	Documentation .....	56			
<b>Part 8</b>	<b>Building Energy Performance Compliance</b>				
8.1.	General .....	57			
8.1.1.	Application .....	57			

---

# Preface

The Model National Energy Code of Canada for Buildings (MNECB) is prepared by the Canadian Commission on Building and Fire Codes (CCBFC) and is published by the National Research Council (NRC). Since, under the Constitution Act, regulation of building in Canada is the responsibility of provincial and territorial governments, the MNECB is prepared in the form of a model code to permit adoption by the appropriate authority.

Liaison between the Commission and provincial and territorial code authorities is maintained through the Provincial/Territorial Committee on Building Standards, established by these authorities to provide policy guidance to the CCBFC.

This is the first in what may become a series of separate stand-alone or “progeny” documents as envisaged in “Building the Future—The Strategic Plan of the Canadian Commission on Building and Fire Codes, 1995-2000.” Such documents are designed to account for situations in which broad consensus has not been reached as to whether an issue at hand should be controlled by regulation, but where there is sufficient agreement that having model national technical requirements would be beneficial. Regulatory authorities thus have these codes available should they decide to regulate in the subject areas covered by the codes, but can ignore them if such regulation is not part of their government’s agenda.

To identify these “progeny” documents, they will be designated in the title as “model” codes, in recognition that they have not yet achieved the same widespread use and acceptance as other CCBFC model codes such as the National Building Code of Canada (NBC) and the National Fire Code of Canada (NFC).

The MNECB differs from model codes traditionally produced by CCBFC in that it addresses environmental protection and resource conservation issues rather than the health and safety of occupants. It is essentially a set of minimum requirements for energy efficiency in buildings. These requirements are, for the most part, based on extensive cost-benefit analyses that take into consideration climate, fuel types and costs, and construction costs. The MNECB establishes a standard of construction for those features of buildings,

other than small residential buildings, which affect their energy efficiency. Energy efficiency in small residential buildings is addressed by a companion document, the Model National Energy Code of Canada for Houses (MNECH).

The CCBFC and NRC have not taken a position as to whether energy conservation should be regulated. The CCBFC has agreed, in response to requests from provincial and territorial energy ministries and agencies, to produce this model code so that authorities wishing to deal with energy conservation through regulation have access to a consensus-based, technically supportable set of requirements.

Where a jurisdiction has not decided to control energy use through regulation, this document can be used as a guide to a minimum level of energy performance.

The cost analyses on which the MNECB is based were intended to reflect the cost of construction as closely as practical for the regions considered, with due allowance for the essentially unstable nature of such costs and the local variations in construction techniques. Moreover, since the impact of energy conservation features in a building depends to a significant extent on the performance of other surrounding features, a certain degree of conservatism had to be introduced in order to avoid unreasonably stringent requirements. The cost studies for the MNECB did not take into account secondary effects such as the reduction of the size of heating and cooling equipment due to improvements in the building envelope. Similarly, they did not account for the cost of electricity incurred in running a furnace, because such costs will vary with the size and operation of the equipment. They also did not include the energy spent in fabricating and transporting materials, except to the extent that the cost of such energy is reflected in the costs of these materials. Finally, the cost studies did not take into account the effect of expected commercial or industrial processes on the energy consumption of the building, such as the effect of open freezers on heating and cooling in a supermarket, because they are not necessarily permanent fixtures in the building.

The requirements in this Code do not constitute a design procedure. Once the requirements of the Code have been determined, the designer should strive to design actual buildings and systems that will provide an effective and energy-efficient service in accordance with the use of the space, while meeting the requirements of the Code. Some design principles for energy-efficient buildings are contained in various referenced handbooks.

Because the requirements of the MNECB are based to a large extent on economic considerations, and particularly the economics of new construction, this Code is intended primarily to be applied to new construction, including buildings and additions. It may be suitable for application to the alteration or renovation of existing buildings, where the extent of alteration or renovation is such that the economics of new construction apply. For example, since additions to existing buildings are essentially new construction, this Code does apply to additions.

**Committees.** This Code has been developed and continues to be developed through the voluntary assistance of many experts from coast to coast. The members of the CCBFC are appointed by NRC. They serve as individuals and not as designated appointees of any organization and are broadly representative of all major phases of construction in Canada. The CCBFC has direct responsibility under NRC for the preparation and publication of the Code.

The CCBFC is assisted in the technical aspects of code writing by standing committees, each of which is responsible for specific portions of a code or its associated documents. The members of each standing committee are knowledgeable in the particular field for which the committee is responsible. Building and fire officials, architects, engineers, contractors, building owners and others share their experience in the national interest. The committees responsible for the MNECB and their memberships are listed in the following pages.

The CCBFC wishes to acknowledge the assistance provided by the many individuals who have contributed to the production of this edition of the Code and to express its appreciation to the standards development organizations whose standards are referenced throughout the Code documents.

**IRC Staff.** The staff of the Canadian Codes Centre of the Institute for Research in Construction (IRC) of NRC provide technical and administrative support at the direction of the CCBFC. Technical issues identified in developing and maintaining this Code are often referred to the research laboratories of IRC or to other agencies for study, to make available to the CCBFC the most up-to-date information on building technology on which to base its decisions.

**Technical Support.** As this is an entirely new code, a great deal of technical support was needed in its development, an amount beyond the normal capacity of IRC's research laboratories to provide. However, in this case, IRC was able to assemble sufficient resources from its Building Envelope and Structure Program to respond to the CCBFC's needs, thanks to funding provided by the Canadian Electrical Association, National Resources Canada and the energy ministries of provinces and territories. The CCBFC gratefully acknowledges the support of these organizations.

**Changes from the 1983 "Measures for Energy Conservation."** The new energy code incorporates several new and important features that make it significantly more than an updating of "Measures for Energy Conservation in New Buildings," the energy code last published in 1983 by the Associate Committee on the National Building Code (the predecessor to the CCBFC).

As with "Measures," the requirements in the MNECB have been based as much as possible on life-cycle costing, taking into account climate, fuel types and costs, and construction costs. In the case of "Measures," however, this determination was based on national average values for these parameters, whereas the requirements in the MNECB are based on regional values for these parameters, as determined in consultation with provincial/territorial governments. This has resulted in requirements that are economically justified and regionally sensitive. The process of determining these regionally sensitive requirements is described in more detail in Appendix F.

The MNECB also provides alternate compliance paths, allowing designers to follow a simple prescriptive path (with internal trade-off options) or a performance path based on computer simulation, i.e., a great deal of design flexibility is permitted provided it can be shown, using a prescribed computer simulation, that the building will use no more energy than it would if it were to comply with the prescriptive requirements of this Code.

**Coordination with the National Building Code of Canada.** The MNECB is intended to be used in conjunction with the NBC, which is a code of minimum regulations for public health, fire safety and structural sufficiency. For this reason, the MNECB does not address these issues but is based on the assumption that the buildings to which it is applied comply with the NBC or a provincial or municipal code based on the NBC. Those wishing to use the MNECB in conjunction with a building code that differs significantly from the NBC, or in the absence of a building code, should ensure that relevant aspects of the building not addressed in this Code are considered. This would include the installation of insulation, vapour barriers and air

barriers and the effectiveness and safety of heating, ventilating and air-conditioning systems.

**Public Comment and Inquiries.** Comments and inquiries on the use of this Code and suggestions for its improvement are welcomed and should be submitted to:

The Secretary  
Canadian Commission on Building and Fire Codes  
National Research Council Canada  
Ottawa, Ontario  
K1A 0R6.

The Commission also publishes “Guidelines for Proposing Changes to the National Code Documents,” a leaflet describing how to submit a proposed change to a National Code and what material to include to support the proposal.

**Related Documents.** NRC publishes other code-related documents that may be of interest to users of this Code:

**Model National Energy Code for Houses 1997.\***  
A model set of technical requirements for the construction of energy-efficient small residential buildings.

**National Building Code of Canada 1995.** A model set of technical requirements designed to establish a standard of safety for the construction of buildings, including extensions or alterations, the evaluation of buildings undergoing a change of occupancy and the upgrading of buildings to remove an unacceptable hazard.

**National Fire Code of Canada 1995.** A model set of technical requirements designed to provide an acceptable level of fire protection and fire prevention within a community.

**National Plumbing Code of Canada 1995.** Contains detailed requirements for the design and installation of plumbing systems in buildings.

**National Farm Building Code of Canada 1995.** A model set of minimum requirements affecting human health, fire safety and structural sufficiency for farm buildings.

**National Housing Code of Canada and Illustrated Guide 1997.\*** A compilation of all requirements from the National Building Code of Canada 1995 that apply to small residential buildings, including detached, semi-detached and row houses without shared egress.

**User’s Guide — NBC 1995 Fire Protection, Occupant Safety and Accessibility (Part 3).** Explains

the intent of many Part 3 requirements and provides a background to and reasons for many of its more complex requirements.

**User’s Guide — NBC 1995 Structural Commentaries (Part 4).** Provides commentaries on the structural design requirements of Part 4 of the Code, including a new commentary on Application of NBC Part 4 for the Structural Evaluation and Upgrading of Existing Buildings.

**User’s Guide — NBC 1995 Wind, Water and Vapour Protection (Part 5).\*** Describes the environmental loads on building envelopes, discusses means to respond to those loads, and indicates how the Code requirements relate to current knowledge of building envelope design and construction theory and practice.

**User’s Guide — NBC 1995 Housing and Small Buildings (Part 9).\*** Describes the principles behind many of the requirements of Part 9 and some of the historical background where this will assist users in understanding the objectives of certain provisions.

**CCBFC Policies and Procedures 1992.** Contains the terms of reference and operating procedures of the CCBFC and its standing committees, a statement on the supporting role of the Institute for Research in Construction of NRC and the membership matrices for the various standing committees.

**Copyright.** Copyright in the Model National Energy Code of Canada for Buildings is owned by the National Research Council of Canada. All rights are reserved. Reproduction of the Council’s copyright material by any means is prohibited without the written consent of the NRC. Requests for permission to reproduce the MNECB must be sent to: Head, Canadian Codes Centre, Institute for Research in Construction, National Research Council Canada, Ottawa, Ontario K1A 0R6.

\* Scheduled for publication in Fall/Winter 1997.



---

# A Guide to the Use of this Code

The MNECB is essentially a code of minimum regulations for energy efficiency in buildings, which takes into consideration climate, fuel types and costs, and construction costs. It establishes a standard of construction for the energy-related features of buildings, other than small residential buildings, including additions to existing buildings. It is not intended to be a textbook on building design, advice on which should be sought from professional sources. Its primary purpose is the promotion of a reasonable minimum level of energy efficiency in new buildings through the application of appropriate uniform building standards throughout Canada.

This Code is drafted in such a way that it may be adopted or enacted for legal use by any jurisdictional authority in Canada. It is divided into 8 Parts. A decimal numbering system has been used throughout the Code. The first number indicates the Part of the Code; the second, the Section in the Part; the third, the Subsection and the fourth, the Article in the Subsection. An Article may be further broken down into Sentences (indicated by numbers in brackets), and the Sentence further divided into Clauses and Subclauses. These divisions are illustrated as follows:

2	Part
2.8.	Section
2.8.2.	Subsection
2.8.2.1.	Article
2.8.2.1.(1)	Sentence
2.8.2.1.(1)(a)	Clause
2.8.2.1.(1)(a)(i)	Subclause

A summary of the contents of the Code follows:

## Part 1: Scope and Definitions

Part 1 describes the buildings and parameters covered by this Code. It also contains the definitions of all terms that have a constrained or specific meaning for the purposes of this Code. These terms appear in italic type where they are used in the Code. This Part also contains a list of abbreviations used in the Code.

## Part 2: General Requirements

Part 2 contains provisions of an administrative nature such as the use of referenced documents, climatic data, plans and specifications; calculation methods; provision for equivalent materials, systems, equipment, and procedures; and the construction review process.

## Part 3: Building Envelope

This Part contains requirements related to the thermal resistance and airtightness of the various building assemblies that make up the building envelope.

## Part 4: Lighting

This Part contains requirements intended to minimize energy use for lighting and to encourage the provision of means of efficiently controlling lighting.

## Part 5: Heating, Ventilating and Air-conditioning Systems

This Part includes requirements for the design and installation of heating, ventilating and air-conditioning systems with the characteristics and controls necessary to operate efficiently.

## Part 6: Service Water Heating Systems

This Part includes requirements for the design and installation of service water heating systems with the characteristics and controls necessary to operate efficiently.

## Part 7: Electrical Power

This Part contains requirements for those electricity-consuming features of buildings not covered in Parts 4, 5 and 6.

## Part 8: Building Energy Performance Compliance

Part 8 provides an alternative to the prescriptive requirements of other parts by specifying a means of demonstrating that a building will not use more energy than if it were to comply with those prescriptive requirements.

---

## **Appendix A: Regional Requirements**

Appendix A contains tables of regional requirements for the thermal characteristics of the envelope, for heat recovery and for energy source adjustment factors. These requirements form part of the prescriptive requirements of this Code, to the extent that the tables apply to the administrative region considered.

## **Appendix B: Thermal Characteristics of Common Building Assemblies**

Appendix B contains tables providing thermal characteristics of common building assemblies, such as exterior walls, windows, doors, roofs, exposed floors, foundation walls and floors on ground. They are given as an aid in assessing the compliance of building assemblies to the regional requirements of this Code and as such form part of its requirements.

## **Appendix C: Method for Calculating the Thermal Properties of Building Assemblies**

Appendix C describes methods required in Part 2 to be used in establishing the overall thermal transmittance of building assemblies for the purpose of checking compliance with the requirements of this Code. These methods form part of the requirements of this Code.

## **Appendix D: Energy Source Adjustment Factors**

Appendix D contains a table of regional energy source adjustment factors used in determining the principal heating source of a building and used by the computer-assisted trade-off software and the performance compliance software. This table forms part of the mandatory requirements of this Code.

## **Appendix E: Commentary**

Appendix E contains additional explanatory information to assist Code users in understanding the intent of the requirements contained in Parts 1 to 8. Appendix E does not form part of the requirements of this Code.

## **Appendix F: Determination of Regionally Sensitive Requirements**

Appendix F explains the calculation method used to establish the levels of the regional requirements of the Code and details the parameters considered. It allows the reader to understand the logic behind the requirements. Appendix F does not form part of the requirements of this Code.

## **Appendix G: Conversion Factors**

Appendix G gives a table of factors for converting units used in this Code from the metric system

to the imperial system. Appendix G does not form part of the requirements of this Code.

# Canadian Commission on Building and Fire Codes and Standing Committees

## Canadian Commission on Building and Fire Codes

E.I. Lexier ( <i>Chair</i> )	F.L. Nicholson
R.J. Desserud <sup>(1)</sup> ( <i>Deputy Chair</i> )	F.-X. Perreault
H.E. Carr	W.A. Porter
B.E. Clemmensen	T.L. Powell
J.G. Delage	W. Purchase
R.H. Duke	J. Reimer
G.S. Dunlop	J.M. Rubes
F.H.C. Edgecombe	C.A. Skakun
A. Forcier	M. Soper
C. Frégeau	A.C. Spurrell
P. Guérin	G.M. Taylor
R.B. Hasler	A.M. Thorimbert
J.C. Jofriet	D.K. Turner
S. Lacroix	E.Y. Uzumeri
J.G. MacGregor	F. Vaculik
E.I. Mackie	H.P. Vokey
D.E.J. Magnusson	
M. Maillet	A.J.M. Aikman <sup>(1)</sup>
R.J. McGrath	J.C. Haysom <sup>(1)</sup>
D.O. Monsen	M. Walsh <sup>(1)</sup>
G.R. Morris	

## CCBFC French Technical Verification Committee

F.-X. Perreault ( <i>Chair</i> )	I. Wagner
A. Gobeil	
G. Harvey	Y.E. Forgues <sup>(1)</sup>
S. Larivière	P. Myre-Bisaillon <sup>(1)</sup>
C. Millaire	M.K. Payant <sup>(1)</sup>
J.-P. Perreault	C. St-Louis <sup>(1)</sup>
	L. Tessier <sup>(1)</sup>

(1) IRC staff who provided assistance to the Committee.

(2) Term completed during the preparation of the 1997 Model National Energy Codes.

## Standing Committee on Energy Conservation in Buildings

E.I. Mackie ( <i>Chair</i> )	K. Klassen
W.G. Colborne	G. Lallier
D.F. Colwell	K.W. Lau
J.J. Doll	M.A. Riley
R.S. Dumont	D. Reich
P.E. Dumouchel	C.J. Smith
G. Foote	W.A. Smithies
C.A.E. Fowler	W. Webster
A. Gagné <sup>(2)</sup>	K. Wilson
S.T. Gertsman	
R. Gervais	G.A. Chown <sup>(1)</sup>
J. Gibson	J.C. Haysom <sup>(1)</sup>
R.L. Hajas <sup>(2)</sup>	M. Lacroix <sup>(1)</sup>
A.D. Jenkins	D. Sander <sup>(1)</sup>
D.D. Kerr	M.C. Swinton <sup>(1)</sup>



---

# Part 1

## Scope and Definitions

### Section 1.1. General

#### 1.1.1. Administration

##### 1.1.1.1. Administrative Requirements

1) This Code shall be administered in conformance with the relevant provincial, territorial or municipal regulations or, in the absence of such regulations, in conformance with the Canadian Commission on Building and Fire Codes' Administrative Requirements for Use with the National Building Code of Canada.

#### 1.1.2. Scope

##### 1.1.2.1. Buildings Covered by this Code

1) Except as provided in Sentences (2) to (5), the requirements of this Code apply to the design, construction and *occupancy* of new *buildings* and to *additions* to existing *buildings* (see Appendix E).

2) The following *buildings* shall comply with the Model National Energy Code for Houses 1997:

- a) new *buildings* of 3 *storeys* or less in *building height*, having a *building area* not exceeding 600 m<sup>2</sup> and containing only *dwelling units*, related ancillary *service rooms*, shared means of egress or garages serving the units,
- b) all new *buildings* of *residential occupancy* containing not more than one *dwelling unit*, and
- c) *additions* to existing *buildings* of the types described in Clauses (a) and (b).

(See Appendix E.)

3) This Code does not apply to *buildings* less than 10 m<sup>2</sup> in *building area*.

4) This Code does not apply to *farm buildings*.

5) The *authority having jurisdiction* may exempt a *building* or part of a *building* from some or all of the requirements of this Code where it can be shown that the nature or duration of the *occupancy* makes it impractical to apply those requirements (see Appendix E).

##### 1.1.2.2. Building Parameters Covered by this Code

1) This Code defines requirements for the design and construction of the *building envelope*, and the design and construction or specification of systems and equipment for heating, ventilating or air-conditioning, *service water* heating, lighting, and provision of electrical power, excluding process loads.

##### 1.1.2.3. Relationship to Other Building Regulations

1) This Code is to be used in conjunction with the relevant provincial, territorial or municipal building regulations or, in the absence of such regulations, in conjunction with the National Building Code of Canada.

2) In cases where the requirements of this Code are in conflict with the requirements of the relevant provincial, territorial or municipal building regulations or, where relevant, with the National Building Code of Canada, the requirements of the relevant building regulations shall supersede those of this Code.

#### 1.1.3. Definitions of Words and Phrases

##### 1.1.3.1. Words Not Defined Herein

1) Words and phrases used in this Code that are not included in the list of definitions in this Part shall have the meanings that are commonly assigned to them in the context in which they are used in this Code, taking into account the specialized use of terms within the various trades and professions to which the terminology applies (see Appendix E).

##### 1.1.3.2. Words Italicized in this Code

1) The words and terms in italics in this Code have the following meanings:

*Addition* means any *conditioned space* that is added to an existing *building* and that increases the *building's floor surface area* by more than 10 m<sup>2</sup>.

*Air flow control area* means a portion of a *building* to which the flow of air from the heating, ventilating

### 1.1.3.2.

or air-conditioning air distribution system can be reduced or stopped without reducing or stopping the flow of air to other portions of the *building*.

*Annual adjusted energy consumption* means the annual sum of the lighting energy consumption, *service water* heating energy consumption and space-conditioning energy consumption of the proposed *building* design, as calculated in accordance with the requirements of Part 8 of this Code.

*Assembly occupancy\** means the *occupancy* or the use of a *building*, or part thereof, by a gathering of persons for civic, political, travel, religious, social, educational, recreational or like purposes, or for the consumption of food or drink (see Appendix E).

*Attic\** means the space between the roof and the ceiling of the top *storey* or between a dwarf wall and a sloping roof.

*Authority having jurisdiction\** means the governmental body responsible for the enforcement of any part of this Code or the official or agency designated by that body to exercise such a function.

*Boiler* means an appliance intended to supply hot water or steam for space or *service water* heating purposes, except *storage-type service water heaters*.

*Building\** means any structure used or intended for supporting or sheltering any use or *occupancy*.

*Building area\** means the greatest horizontal area of a *building* above *grade* within the outside surface of exterior walls or within the outside surface of exterior walls and the centre line of *firewalls*.

*Building energy target* means the *annual adjusted energy consumption* of a hypothetical replica of the proposed *building*, using the same energy sources for the same functions and having the same environmental requirements, *occupancy*, climate data and operation schedules, but made to comply with all applicable prescriptive requirements of this Code.

*Building envelope* means the collection of components that separate *conditioned space* from unconditioned space, the exterior air or the ground, or which separate *conditioned spaces* that are intended to be conditioned to temperatures differing by more than 10°C at design conditions (see Appendix E).

*Building height\** (in *storeys*) means the number of *storeys* contained between the roof and the floor of the *first storey*.

*Business and personal services occupancy\** means the *occupancy* or use of a *building* or part thereof for the transaction of business or the rendering or re-

ceiving of professional or personal services (see Appendix E).

*Care or detention occupancy\** means the *occupancy* or use of a *building* or part thereof by persons who require special care or treatment because of cognitive or physical limitations or by persons who are restrained from, or are incapable of, self-preservation because of security measures not under their control (see Appendix E).

*Ceiling height (CH)* means the average height of the ceiling where there is a ceiling and the average height of the base of the installed luminaires where there is no ceiling.

*Coefficient of performance (COP)* means, for a heat pump in the heating mode, the ratio of the rate of net heat output to the total energy input expressed in consistent units and under designated rating conditions, as described in the referenced standards; for refrigerating equipment or a heat pump in the cooling mode, COP means the ratio of the rate of heat removal to the rate of energy input in consistent units and under designated rating conditions, as described in the referenced standards.

*Combustion efficiency (E<sub>c</sub>)* means a measure of the efficiency of fuel-burning equipment in converting fuel to heat, as obtained through the procedures described in the referenced standards.

*Conditioned space* means any space within a *building*, the air temperature of which is controlled to limit variation in response to the exterior ambient air temperature or interior differential temperatures by the provision, either directly or indirectly, of heating or cooling over substantial periods of the year (see Appendix E).

*Dwelling unit\** means a *suite* operated as a house-keeping unit, used or intended to be used as a domicile by one or more persons and usually containing cooking, eating, living, sleeping and sanitary facilities.

*Effective thermal resistance (RSI-value)* means the inverse of the *overall thermal transmittance*. For assemblies in contact with the ground, it excludes the resistance of the ground and exterior air film on the surface of the ground.

*Energy-efficiency ratio (EER)*, for refrigerating equipment or a heat pump in the cooling mode, means the ratio of net cooling capacity in Btu/h to the total rate of electric input in watts, under designated operating conditions, as described in the referenced standards.

*Energy factor (EF)* means a dimensionless measure of the overall efficiency of a *service water* heater and is obtained as described in the referenced standards.

*Energy rating (ER)* means a method of rating the relative thermal performance of windows that gives,

\* The definition for this word or term is identical to that in the National Building Code of Canada 1995.

in a single number, a window's combined response to solar heat gain, conductive heat loss and air leakage in typical Canadian climatic conditions. It is based on the total performance of all window components, including glazing, spacers, sash and frame.

*Energy source adjustment factor* means the factor by which the consumption of a given energy source is multiplied to obtain the *annual adjusted energy consumption* of a *building* for the purposes of trade-off calculations described in Section 3.4. and *building* energy performance compliance calculations described in Part 8, where more than one energy source is used by the *building*.

*Exhaust duct* means a duct through which air is conveyed from an interior space to the outdoors or to unconditioned space.

*Exit\** means that part of a *means of egress†*, including doorways, that leads from the *floor area†* it serves, to a separate *building*, an open public thoroughfare, or an exterior open space protected from fire exposure from the *building* and having access to an open public thoroughfare.

*Exterior entrance* means a doorway that is used for entering, or entering and exiting, a *building*, which leads from an exterior space to the area served by the entrance, and where the area served is provided with *interior lighting*.

*Exterior exit* means a doorway that is used for exiting only, which leads from the area it serves to an exterior space, and where the area served is provided with *interior lighting*.

*Exterior lighting* means lighting that is not defined as *interior lighting*.

*Facade lighting* means lighting installed to highlight features of the principal front of a *building* or a face of a *building* that overlooks a street or open space. *Facade lighting* includes lighting installed on the facade and lighting installed on constructed or natural surfaces in close proximity to the facade. *Facade lighting* does not include signage, or other lighting installed on the facade but intended to light exterior spaces or surfaces other than the facade.

*Farm building\** means a *building* or part thereof that does not contain a *residential occupancy* and that is associated with and located on land devoted to the practice of farming, and used essentially for the housing of equipment or livestock, or the production, storage or processing of agricultural and horticultural produce or feeds.

*Fenestration* means all *building envelope* assemblies that transfer visible light, including windows, clerestories, *skylights*, glass blocks, transoms, side-

lights, sliding or swinging glass doors, and glazed inserts in doors.

*Fenestration-to-wall ratio* means a parameter that is calculated as described in Sentence 2.2.2.8.(4) and that is used in the establishment of required thermal characteristics of *fenestration* from tables in Appendix A.

*Firewall\** means a type of *fire separation†* of *noncombustible construction†* that subdivides a *building* or separates adjoining *buildings* to resist the spread of fire and that has a *fire-resistance rating†*, as prescribed in the National Building Code of Canada, and has structural stability to remain intact under fire conditions for the required fire-rated time.

*First storey\** means the uppermost *storey* having its floor level not more than 2 m above *grade*.

*Floor surface area* means the area of a floor surface, including heated garages, measured from the interior surface of the perimeter walls at or near floor level, including the area occupied by columns, interior walls and openings in the floor.

*Foundation\** means a system or arrangement of *foundation units†* through which the loads from a *building* are transferred to the supporting *soil†* or *rock†*.

*Frame* in a door, window or other glazed area means the associated head, jambs, sill and, where applicable, mullions that, when assembled, house the door, sash or fixed glazing.

*Furnace\** means a *space-heating appliance* using warm air as the heating medium and usually having provision for the attachment of ducts.

*Grade\** (as applying to the determination of *building height*) means the lowest of the average levels of finished ground adjoining each exterior wall of a *building*, except that localized depressions such as those for vehicle or pedestrian entrances need not be considered in the determination of average levels of finished ground (See *First storey*).

*Gross lighted area (GLA)* means the total area served by *interior lighting*, including the areas occupied by *partitions* but excluding areas occupied by exterior enclosing assemblies and by elevator and service shafts (see Appendix E).

*Heat trap* means an energy-conserving arrangement of the water piping entering or leaving a *service water* heater constructed to counteract the convective forces of the hot water (thermosyphoning) during standby periods.

*Industrial occupancy\** means the *occupancy* or use of a *building* or part thereof for the assembling, fabricating, manufacturing, processing, repairing or storing of goods and materials (see Appendix E).

*Integrated part-load value (IPLV)* means a single-number figure of merit based on part-load *energy-efficiency ratio* or *coefficient of performance*

† See the National Building Code of Canada 1995 for these definitions.

### 1.1.3.2.

expressing part-load efficiency for air-conditioning and heat pump equipment on the basis of weighted operation at various load capacities for the equipment, as described in the referenced standards.

*Interior lighting* means

- (a) lighting installed in spaces that are within the *building envelope*,
- (b) lighting installed in spaces that are sheltered from the outdoor environment, whether or not they are *conditioned spaces*, where the lighting is intended to light only those spaces, except for spaces at *exterior entrances* and *exterior exits*, and
- (c) lighting installed in unsheltered exterior spaces that serve *occupancies* that are usually accommodated within the confines of the *building envelope*.

(See Appendix E.)

*Landscape lighting* means lighting installed to highlight landscape elements, such as trees, shrubs, rocks and pools. *Landscape lighting* does not include lighting of exterior spaces or walkways.

*Luminous efficacy* means the total luminous flux emitted by a luminaire divided by the total power input to the luminaire, including lamps and ballasts.

*Mercantile occupancy\** means the *occupancy* or use of a *building* or part thereof for the displaying or selling of retail goods, wares or merchandise (see Appendix E).

*Occupancy\** means the use or intended use of a *building* or part thereof for the shelter or support of persons, animals or property.

*Opaque component* of the *building envelope* means a *building* assembly that does not let any light pass through, and refers to assemblies other than *fenestration* and doors.

*Overall thermal transmittance (U-value)* is a measure of the rate at which heat is transferred through a *building* assembly subject to a temperature difference. It is expressed as the amount of heat transferred through a unit area in a unit of time induced under steady-state conditions by a unit temperature difference between the environments on its two faces. As used in this Code, it reflects the resistance to such heat transfer of all elements through the thickness of the assembly, as well as that of air films on both faces. Where the resistance to heat transfer is not homogeneous across the area being considered, an average value of the *overall thermal transmittance* must be calculated in accordance with the procedures prescribed in this Code.

*Partition\** means an interior wall one *storey* or part-*storey* in height that is not *loadbearing*<sup>†</sup>.

*Party wall*<sup>†</sup> means a wall jointly owned and jointly used by 2 parties under easement agreement or by right in law and erected at or upon a line separating 2 parcels of land each of which is, or has the potential of being, a separate real-estate entity.

*Plenum\** means a chamber forming part of an air duct system.

*Principal heating source* of a *building* or part of a *building* means the source with the highest *energy source adjustment factor* in Table D-1 of Appendix D that accounts for more than 10% of the installed space-heating capacity for the *building* or part of the *building*. In the case of purchased heat, the *principal heating source* of the plant supplying the heat shall be considered (see Appendix E).

*Repair garage\** means a *building* or part thereof where facilities are provided for the repair or servicing of motor vehicles.

*Residential occupancy\** means the *occupancy* or use of a *building* or part thereof by persons for whom sleeping accommodation is provided but who are not harboured or detained to receive medical care or treatment or are not involuntarily detained (see Appendix E).

*Return duct*<sup>†</sup> means a duct for conveying air from a space being heated, ventilated or air-conditioned back to the heating, ventilating or air-conditioning *appliance*<sup>†</sup>.

*RSI-value* — see *effective thermal resistance*.

*Sash* means an assembly of secondary framing members that fits within the primary *frame* of a window and whose main purpose is to hold and support the glass in operable windows; however, a *sash* is often included in fixed windows to maintain a uniform appearance with operable windows.

*Service establishment* means an establishment where functional performance is important and tasks are related to the provision of personal services such as hair cutting and styling, self-service laundries, drycleaning, and small tool and appliance rental and repair.

*Service room\** means a room provided in a *building* to contain equipment associated with *building* services (see Appendix E).

*Service space\** means space provided in a *building* to facilitate or conceal the installation of *building* service facilities such as chutes, ducts, pipes, shafts or wires.

*Service water* means water for plumbing services, excluding systems used exclusively for space heating or cooling or for processes.

*Skylight* means a form of *fenestration* that is inclined less than 60° from horizontal.

*Skylight-to-roof ratio* means a parameter calculated as described in Sentence 2.2.2.8.(5) and used in the establishment of required thermal characteristics of *skylights* (see Sentence 3.3.1.2.(2)).

*Solid masonry wall* means a wall made of one or more wythes of solid or hollow units, where there is no cavity or air space between wythes.

*Space heater\** means a *space-heating appliance* for heating the room or space within which it is located, without the use of ducts.

*Space-heating appliance\** means an *appliance†* intended for the supplying of heat to a room or space directly, such as a *space heater*, fireplace or *unit heater*, or to rooms or spaces of a *building* through a heating system such as a central *furnace* or *boiler*.

*Standby losses* are the heat losses incurred by a *storage-type service water heater* under a stable condition when no water is withdrawn from the tank and the water temperature is held constant by the thermostats.

*Storage garage\** means a *building* or part thereof intended for the storage or parking of motor vehicles and containing no provision for the repair or servicing of such vehicles.

*Storage-type service water heater\** means a *service water heater* with an integral hot water storage tank.

*Storey\** means that portion of a *building* that is situated between the top of any floor and the top of the floor next above it, and if there is no floor above it, that portion between the top of such floor and the ceiling above it.

*Suite\** means a single room or series of rooms of complementary use, operated under a single tenancy, and includes *dwelling units*, individual guest rooms in motels, hotels, boarding houses, rooming houses and dormitories, as well as individual stores and individual or complementary rooms for *business and personal services occupancies* (see Appendix E).

*Supply air handler* means that part of a heating, ventilating and air-conditioning system that conditions return air and/or outdoor air and delivers it to the *supply ducts*.

*Supply duct\** means a duct for conveying air from a heating, ventilating or air-conditioning *appliance†* to a space to be heated, ventilated or air-conditioned.

*Temperature-control zone* means the space that is controlled by an individual temperature-control device.

*Theatre\** means a place of public assembly intended for the production and viewing of the performing arts or the screening and viewing of motion pic-

tures, and consisting of an auditorium with permanently fixed seats intended solely for a viewing audience.

*Thermal break* means an insulating material incorporated in a metal window, *skylight* or door *frame* or *sash* to reduce thermal conduction.

*Thermal efficiency (E<sub>t</sub>)* means a measure of the efficiency of fuel-burning equipment in converting fuel to heat, as obtained through the procedures described in the referenced standards.

*U-value* — see *overall thermal transmittance*.

*Unit heater\** means a suspended *space heater* with an integral air circulating fan, which is not ducted.

## 1.1.4. Abbreviations

### 1.1.4.1. Addresses and Abbreviations of Proper Names

1) The abbreviations of proper names in this Code shall have the meanings assigned to them in this Article. The appropriate addresses are shown in brackets following the name.

AGA	American Gas Association (55 Scarsdale Road, Don Mills, Ontario M3B 2R3)
AHAM	Association of Home Appliance Manufacturers (20 North Wacker Drive, Suite 1500, Chicago, Illinois 60606 U.S.A.)
AMCA	Air Movement and Control Association (30 West University Drive, Arlington Heights, Illinois 60004 U.S.A.)
ANSI	American National Standards Institute (11 West 42nd Street, 13th Floor, New York, New York 10036 U.S.A.)
ARI	Air Conditioning and Refrigeration Institute (4301 North Fairfax Drive, Suite 425, Arlington, Virginia 22203 U.S.A.)
ASHRAE	American Society of Heating, Refrigerating and Air-Conditioning Engineers (1791 Tullie Circle N.E., Atlanta, Georgia 30329 U.S.A.)
ASTM	American Society for Testing and Materials (100 Barr Harbor Drive, West Conshohocken, Pennsylvania 19428-2959 U.S.A.)
CAN	National Standard of Canada designation (The number or name following the CAN designation

## 1.1.4.2.

represents the agency under whose auspices the standard is issued. CAN1 designates CGA, CAN2 designates CGSB, and CAN3 designates CSA).

U.S. Government U.S. Government Printing Office (P.O. Box 371954, Pittsburgh, Pennsylvania 15250 U.S.A.)

CCBFC	Canadian Commission on Building and Fire Codes (National Research Council of Canada, Ottawa, Ontario K1A 0R6)
CGA	Canadian Gas Association (International Approval Services Canada Inc., 55 Scarsdale Road, Don Mills, Ontario M3B 2R3)
CGSB	Canadian General Standards Board (Place du Portage, Phase III, 6B1, 11 Laurier Street, Hull, Quebec K1A 1G6)
CSA	Canadian Standards Association (178 Rexdale Blvd., Etobicoke, Ontario M9W 1R3)
CTI	Cooling Tower Institute (P.O. Box 73383, Houston, Texas 77273 U.S.A.)
Government of Canada	Canada Communications Group Publishing (Ottawa, Ontario K1A 0R9)
HI	Hydronics Institute (35 Russo Place, Berkeley Heights, New Jersey 07922 U.S.A.)
HRAI	Heating, Refrigerating and Air-Conditioning Institute of Canada (5045 Orbitor Drive, Building 11, Suite 300, Mississauga, Ontario L4W 4Y4)
IESNA	Illuminating Engineering Society of North America (40 West 13th Street, New York, New York 10011 U.S.A.)
NBC	National Building Code of Canada
NRC	National Research Council Canada (Ottawa, Ontario K1A 0R6)
SMACNA	Sheet Metal and Air Conditioning Contractors National Association Inc. (8224 Old Courthouse Road, Vienna, Virginia 22180 U.S.A.)
TIAC	The Thermal Insulation Association of Canada (44 Byward Market Square, Ottawa, Ontario K1N 7A2)
UL	Underwriters' Laboratories Inc. (1285 Walt Whitman Road, Melville, New York, New York 11747-3081 U.S.A.)

### 1.1.4.2. Symbols and Other Abbreviations

**1)** The symbols and other abbreviations in this Code shall have the meanings assigned to them in this Article.

A	ampere(s)
AF	area factor
BT	building type
Btu	British thermal unit(s)
Btu/h	British thermal unit(s) per hour
CLP	connected lighting power
COP	<i>coefficient of performance</i>
°	degree(s)
°C	degree(s) Celsius
db	dry bulb (temperature)
$E_t$	<i>thermal efficiency</i>
$E_c$	<i>combustion efficiency</i>
EER	<i>energy-efficiency ratio</i>
EF	<i>energy factor</i>
ER	<i>energy rating</i>
°F	degree(s) Fahrenheit
%	per cent
>	greater than
≥	greater than or equal to
<	less than
≤	less than or equal to
GLA	<i>gross lighted area</i>
h	hour(s)
HVAC	heating, ventilating and air-conditioning
ICLP	interior connected lighting power
ILPA	interior lighting power allowance
IPLV	<i>integrated part-load value</i>
kg	kilogram(s)
kVA	kilovolt ampere(s)
kW	kilowatt(s)
L	litre(s)
lin	linear
lm	lumen(s)
LPA	lighting power allowance
LPD	lighting power density
lx	lux
m	metre(s)
max.	maximum
min.	minimum
mm	millimetre(s)

No.	.....	number
o.c.	.....	on centre
Pa	.....	pascal(s)
RSI	.....	thermal resistance value in the metric system
s	.....	second(s)
SF	.....	space function
SL	.....	standby loss
$\Delta t$	.....	temperature difference
US gal.	.....	US gallon(s)
V	.....	volt(s)
$V_t$	.....	storage volume
W	.....	watt(s)
wb	.....	wet bulb (temperature)
wt	.....	weight



# Part 2

## General Requirements

### Section 2.1. General

#### 2.1.1. Compliance

##### 2.1.1.1. Compliance with Mandatory Provisions

1) *Buildings* within the scope of this Code shall comply with the mandatory provisions of Sections 3.2., 4.2., 5.2., 6.2. and 7.2.

##### 2.1.1.2. Prescriptive or Performance Compliance

(See Appendix E.)

- 1) Except as provided in Sentence (2), *buildings* shall comply with
- the prescriptive requirements of Part 3, Building Envelope; Part 4, Lighting; Part 5, Heating, Ventilating and Air-conditioning Systems; and Part 6, Service Water Heating Systems; or
  - the performance requirements of Part 8, Building Energy Performance Compliance.
- 2) *Building envelope* components need not comply with the prescriptive requirements of Section 3.3. if compliance can be shown using the trade-off procedures in Section 3.4.

### Section 2.2. Basic Data and Calculation Methods

#### 2.2.1. Climatic Data

##### 2.2.1.1. Climatic Values

1) The climatic values required for the design of *buildings* under this Code shall be in conformance with the values established by the *authority having jurisdiction* or, in the absence of such data, with the climatic values in Appendix C, Climatic Information for Building Design in Canada, of the National Building Code of Canada for the location nearest to the *building* site (see Appendix E).

#### 2.2.2. Calculation Procedures

##### 2.2.2.1. Good Practice

1) Calculations carried out to ensure compliance with this Code and not described in the balance of this Subsection or in other Parts of this Code shall be carried out using procedures recognized as good practice for the particular purposes.

##### 2.2.2.2. Thermal Characteristics of Building Assemblies

(See Appendix E.)

1) The thermal characteristics of materials shall be determined in accordance with the relevant product standards listed in the National Building Code or, in the absence of such a standard or where such a standard does not address determination of thermal characteristics, in accordance with ASTM Standard C 518, "Standard Test Method for Steady-State Heat Flux Measurements and Thermal Transmission Properties by Means of the Heat Flow Meter Apparatus," or ASTM Standard C 177, "Standard Test Method for Steady-State Heat Flux Measurements and Thermal Transmission Properties by Means of the Guarded-Hot-Plate Apparatus."

2) Calculations and tests performed according to Sentence (1) shall be carried out at an average temperature of 24°C ( $\pm 3^\circ\text{C}$ ) and under a temperature difference of 22°C ( $\pm 2^\circ\text{C}$ ).

3) The *overall thermal transmittance* of windows and of sliding glass doors that are within the scope of CSA Standard A440.2, "Energy Performance Evaluation of Windows and Sliding Glass Doors" shall be determined for the reference sizes listed in accordance with that standard.

4) The *overall thermal transmittance* of forms of *fenestration* not covered under Sentence (3) shall be determined from

- calculations carried out using the procedure described in the ASHRAE Handbook — Fundamentals, or
- laboratory tests performed in accordance with ASTM C 236, "Standard Test Method for Steady-State Thermal Performance of Building Assemblies by Means of a Guarded Hot Box."

### 2.2.2.3.

5) Calculations and tests performed according to Sentence (4) shall be carried out on the basis of reference window sizes called for in CSA Standard A440.2, "Energy Performance Evaluation of Windows and Sliding Glass Doors."

6) Tests conducted according to Clause (4)(b) shall be carried out with an indoor air temperature of 21°C ( $\pm 1^\circ\text{C}$ ) and an outdoor air temperature of  $-18^\circ\text{C}$  ( $\pm 1^\circ\text{C}$ ) measured at the mid-height of the window.

7) The overall thermal transmittance of swinging doors that are within the scope of CSA Standard A453, "Energy Performance Evaluation of Swinging Doors," shall be determined for the reference sizes listed in accordance with that standard.

8) The thermal characteristics of other building assemblies shall be determined from

- a) the tables in Appendix B,
- b) calculations carried out using the procedure described in Appendix C, or
- c) laboratory tests performed in accordance with ASTM Standard C 236, "Standard Test Method for Steady-State Thermal Performance of Building Assemblies by Means of a Guarded Hot Box."

(See Appendix E.)

9) Tests conducted according to Clause (8)(c) shall be carried out at an average temperature of 24°C ( $\pm 3^\circ\text{C}$ ) and under a temperature difference of 22°C ( $\pm 2^\circ\text{C}$ ).

#### 2.2.2.3. Areas of Roof Assemblies

1) For the purposes of trade-off calculations described in Section 3.4. and building energy performance compliance calculations described in Part 8, the insulated surface areas of roof assemblies

- a) shall be calculated along the plane of the insulation using dimensions measured to the interior surfaces of intersecting exterior walls, and
- b) shall exclude openings for skylights and chimneys as measured to the surfaces of structural framing surrounding such openings.

#### 2.2.2.4. Areas of Above-ground Wall Assemblies

1) For the purposes of trade-off calculations described in Section 3.4. and building energy performance compliance calculations described in Part 8, the insulated surface areas of exterior above-ground wall assemblies

- a) shall be calculated using dimensions measured to the interior surfaces of intersecting exterior walls and to the exterior ground level, but shall not include the

perimeter areas where floor or roof slabs interrupt the wall construction (see Appendix note E-3.2.2.2.(1));

- b) shall include perimeter areas of intersecting interior walls; and
- c) shall exclude openings for doors and fenestration, as measured to the surfaces of structural framing surrounding such openings.

#### 2.2.2.5. Areas of Above-ground Floor Assemblies

1) For the purposes of trade-off calculations described in Section 3.4. and building energy performance compliance calculations described in Part 8, the insulated surface areas of above-ground exterior floor assemblies shall be calculated using dimensions measured to the interior surface of perimeter walls.

#### 2.2.2.6. Areas of Wall Assemblies in Contact with the Ground

1) For the purposes of building energy performance compliance calculations described in Part 8, the insulated surface areas of wall assemblies in contact with the ground shall be calculated using dimensions measured horizontally to the interior surfaces of perimeter wall assemblies in contact with the ground and vertically from the exterior ground level to the surface of intersecting floors in contact with the ground.

#### 2.2.2.7. Areas of Floor Assemblies in Contact with the Ground

1) For the purposes of building energy performance compliance calculations described in Part 8, the insulated surface areas of floor assemblies in contact with the ground shall be calculated using dimensions measured to the interior surfaces of perimeter walls.

#### 2.2.2.8. Areas of Doors and Fenestration

1) For the calculation of the fenestration-to-wall ratio and of the skylight-to-roof ratio, doors and fenestration shall be considered to include all related frame and sash members (in addition to the glazing) and their areas shall be measured to the rough opening in the wall (see Appendix E).

2) Except as provided in Sentence (3), the area of fenestration made of curved panes or flat panes that are not all in the same plane shall be measured along the glass surface (see Appendix E).

3) The area of skylights having a rough opening of not more than 5 m<sup>2</sup> and for which the height above the curb is not greater than half the

largest dimension of the base may be approximated by multiplying the area of the rough opening by 1.5.

4) The *fenestration-to-wall ratio* shall be calculated as the total area of *fenestration*, as determined in Sentences (1) and (2), divided by the sum of the areas of the projections onto vertical planes of all above-ground *building envelope* components, including *fenestration* (see Appendix E).

5) The *skylight-to-roof ratio* shall be calculated as the total area of *skylights*, as determined in Sentences (1) and (2), divided by the sum of insulated roof areas plus *skylights*.

6) For the purpose of *fenestration-to-wall ratio* and *skylight-to-roof ratio* calculations, the compliance of *additions* shall be based upon either

- a) the *addition* being considered by itself, or
- b) the *addition* being considered together with the existing *building*.

## Section 2.3. Documentation

### 2.3.1. General

#### 2.3.1.1. Required Information

1) Sufficient information shall be provided to show that the proposed work will conform to this Code (see Appendix E).

#### 2.3.1.2. Required Plans

1) Plans shall be drawn to scale and shall indicate the nature and extent of the work and proposed *occupancy* in sufficient detail to establish that, when completed, the work and the proposed *occupancy* will conform to this Code.

#### 2.3.1.3. Design Calculations and Analysis

1) The calculations and analysis made in the process of ensuring conformity with the requirements of this code shall be available for inspection upon request.

## Section 2.4. Materials, Appliances, Systems and Equipment

### 2.4.1. General

#### 2.4.1.1. Characteristics

1) All materials, appliances, systems and equipment installed to meet the requirements of this Code shall possess the necessary characteristics to

perform their intended functions when installed in a *building*.

#### 2.4.1.2. Storage on the Building Site

1) All *building* materials, appliances and equipment on the *building* site shall be stored in such a way as to prevent deterioration or impairment of their essential properties.

#### 2.4.1.3. Used Materials, Appliances and Equipment

1) Unless otherwise specified, used materials, appliances and equipment may be reused when they meet the requirements of this Code for new materials and are satisfactory for the intended use.

## Section 2.5. Equivalents

### 2.5.1. General

#### 2.5.1.1. Alternate Materials, Appliances, Systems and Equipment Permitted

1) The provisions of this Code are not intended to limit the appropriate use of materials, appliances, systems, equipment, methods of design, methods of calculations or construction procedures not specifically described herein.

#### 2.5.1.2. Evidence of Equivalent Performance

1) Any person wishing to provide an equivalent to satisfy one or more of the requirements of this Code shall submit sufficient evidence to demonstrate that the proposed equivalent will provide the level of performance required by this Code.

#### 2.5.1.3. Equivalence Demonstrated by Past Performance, Test or Evaluation

1) Materials, appliances, systems, equipment, methods of design, methods of calculation and construction procedures not specifically described herein, or that vary from the specific requirements in this Code, may be used if it can be shown that these alternatives are suitable on the basis of past performance, tests or evaluations (see Appendix E).

#### 2.5.1.4. Equivalent Test Standards

1) The results of tests based on test standards other than as described in this Code may be used provided such alternate test standards will provide comparable results.

## 2.6.1.1.

# Section 2.6. Referenced Documents

## 2.6.1. Application

### 2.6.1.1. Application to Buildings

1) The provisions of referenced documents in this Code apply only to the extent that they relate to the purpose of this Code.

### 2.6.1.2. Conflicting Requirements

1) In the case of conflict between the provisions of this Code and those of a referenced document, the provisions of this Code shall govern.

### 2.6.1.3. Effective Date

1) Unless otherwise specified herein, the documents referenced in this Code shall include all amendments, revisions and supplements effective to 30 June 1996.

2) Where documents are referenced in this Code, they shall be the editions designated in Table 2.6.1.3.

**Table 2.6.1.3.**  
**Documents Referenced in the Model National Energy Code for Buildings 1997**  
Forming Part of Sentence 2.6.1.3.(2)

Issuing Agency	Document Number	Document Title	Code Reference
AGA	ANSI Z21.10.3-1993	Gas Water Heaters-Volume III—Storage, with Input Ratings above 75,000 Btu per Hour, Circulating and Instantaneous Water Heaters (including Addenda)	Table 6.2.2.1.
AGA	ANSI Z21.13-1991	Gas-Fired Low-Pressure Steam and Hot Water Boilers (including Addenda Z21.13a-1993 and Z21.13b-1994)	Table 5.2.13.1.
AGA	ANSI Z21.47-1993	Gas-Fired Central Furnaces (except Direct-Vent Central Furnaces) (revision and consolidation of ANSI Z21.47-1990, Z21.47a-1990, Z21.47b-1992, Z21.64-1990 and Z21.64a-1992, and CAN/CGA 2.3-M87)	Table 5.2.13.1.
AGA	ANSI Z21.56-1994	Gas-Fired Pool Heaters	Table 6.2.2.1.
AHAM	ANSI/AHAM RAC-1-1982 (R1992)	Room Air Conditioners	Table 5.2.13.1.
AMCA	Standard 500-1989	Test Methods for Louvers, Dampers and Shutters	Table 5.2.3.2.(2)
ANSI	C82.11-1993	High-Frequency Fluorescent Lamp Ballasts	4.2.5.1.(2)
ARI	210/240-94	Unitary Air-Conditioning and Air-Source Heat Pump Equipment (Addendum)	Table 5.2.13.1.
ARI	340-93	Commercial and Industrial Unitary Heat Pump Equipment	Table 5.2.13.1.
ARI	360-93	Commercial and Industrial Unitary Air-Conditioning Equipment	Table 5.2.13.1.
ARI	365-94	Commercial and Industrial Unitary Air-Conditioning Condensing Units	Table 5.2.13.1.
ASHRAE		ASHRAE 1997 Handbook—Fundamentals, SI edition	2.2.2.2.(4)(a)
ASME	ANSI/ASME PTC 4.1-1964 (R1991)	Performance Test Code—Steam Generating Units (including addenda ASME 1968 and ASME 1969)	Table 5.2.13.1.
ASTM	C 177-85 (1993)	Standard Test Method for Steady-State Heat Flux Measurements and Thermal Transmission Properties by Means of the Guarded-Hot-Plate Apparatus	2.2.2.2.(1)

Table 2.6.1.3. (Continued)

Issuing Agency	Document Number	Document Title	Code Reference
ASTM	C 236-89 (1993)	Standard Test Method for Steady-State Thermal Performance of Building Assemblies by Means of a Guarded Hot Box	2.2.2.2.(4)(b) 2.2.2.2.(8)(c)
ASTM	C 335-95	Standard Test Method for Steady-State Heat Transfer Properties of Horizontal Pipe Insulation	5.2.4.3.(7) 6.2.3.1.(4)
ASTM	C 518-91	Standard Test Method for Steady-State Heat Flux Measurements and Thermal Transmission Properties by Means of the Heat Flow Meter Apparatus	2.2.2.2.(1)
ASTM	E 283-91	Standard Test Method for Determining Rate of Air Leakage Through Exterior Windows, Curtain Walls, and Doors Under Specified Pressure Differences Across the Specimen	3.2.4.3.(2)(a) 3.2.4.3.(3)
CGA	CAN/CGA-2.3-M93	Gas-Fired Central Furnaces	Table 5.2.13.1.
CGA	CAN/CGA-2.6-M86 (R1996)	Gas Unit Heaters (including August 1986 and January 1989 Amendments)	Table 5.2.13.1.
CGA	CGA 2.8-M86 (R1996)	Gas-Fired Duct Furnaces (including August 1986 and January 1989 Amendments)	Table 5.2.13.1.
CGA	CAN1-4.1-M85	Gas-Fired Automatic Storage Type Water Heaters with Inputs Less than 75,000 Btuh (including November 1992 and June 1994 Amendments)	Table 6.2.2.1.
CGA	CAN1-4.3-M85	Circulating Tank, Instantaneous and Large Automatic Storage Type Gas Water Heaters (including November 1992 Amendment)	Table 6.2.2.1.
CGA	CAN1-4.7-M85 (R1996)	Gas-Fired Pool Heaters	Table 6.2.2.1.
CGA	CGA 4.9-1969	Gas-Fired Steam and Hot Water Boilers (including September 1974 Amendment)	Table 5.2.13.1.
CGSB	CAN/CGSB-82.1-M89	Sliding Doors	3.2.4.3.(1)
CGSB	CAN/CGSB-82.5-M88	Insulated Steel Doors	3.2.4.3.(4)
CSA	CAN/CSA-A440-M90	Windows	3.2.4.2.(1)
CSA	A440.2-93	Energy Performance Evaluation of Windows and Sliding Glass Doors	2.2.2.2.(3) 2.2.2.2.(5)
CSA	A453-95	Energy Performance Evaluation of Swinging Doors	2.2.2.2.(7) 3.3.1.3.(1)
CSA	B125-M93	Plumbing Fittings	6.2.6.1.(1) 6.2.6.2.(1)
CSA	B140.4-1974 (R1991)	Oil-Fired Warm Air Furnaces	Table 5.2.13.1.
CSA	CAN/CSA-B211-M90 (R1996)	Seasonal Energy Utilization Efficiencies of Oil-Fired Water Heaters	Table 6.2.2.1.
CSA	B212-93	Seasonal Energy Utilization Efficiencies of Oil-Fired Furnaces and Boilers	Table 5.2.13.1.
CSA	CAN3-C17-M84 (R1995)	Alternating-Current Electricity Metering	7.2.1.1.(3)
CSA	CAN/CSA-C273.3-M91	Performance Standard for Split-System Central Air-Conditioners and Heat Pumps (including General Instruction No. 4)	Table 5.2.13.1.

## 2.6.1.3.

Table 2.6.1.3. (Continued)

Issuing Agency	Document Number	Document Title	Code Reference
CSA	C273.4-M1978 (R1992)	Performance Requirements for Electric Heating Line-Voltage Wall Thermostats	5.2.7.2.(1)
CSA	CAN/CSA-C368.1-M90 (R1996)	Performance Standard for Room Air Conditioners	Table 5.2.13.1.
CSA	C390-93	Energy Efficiency Test Methods for Three-Phase Induction Motors	7.2.4.2.(1) 7.2.4.2.(2)
CSA	CAN/CSA-C439-88	Standard Methods of Test for Rating the Performance of Heat-Recovery Ventilators	5.3.4.3.(2)
CSA	CAN/CSA-C446-94	Performance of Ground Source Heat Pumps	Table 5.2.13.1.
CSA	CAN/CSA-C654-M91	Fluorescent Lamp Ballast Efficacy Measurements	4.2.5.1.(1) 4.2.5.1.(2)
CSA	CAN/CSA-C655-M91	Performance Standard for Internal Water-Loop Heat Pumps	Table 5.2.13.1.
CSA	CAN/CSA-C656-M92	Performance Standard for Single Package Central Air-Conditioners and Heat Pumps (including General Instruction No. 2)	Table 5.2.13.1.
CSA	C743-93	Performance Standard for Rating Packaged Water Chillers	Table 5.2.13.1.
CSA	C744-93	Standard for Packaged Terminal Air Conditioners and Heat Pumps (Bi-national Standard, with ARI 310/380-93)	Table 5.2.13.1.
CSA	CAN/CSA-C745-95	Energy Efficiency of Electric Storage Tank Water Heaters and Heat Pump Water Heaters	Table 6.2.2.1.
CSA	CAN/CSA-C746-93	Performance Standard for Rating Large Air Conditioners and Heat Pumps	Table 5.2.13.1.
CSA	C748-94	Performance of Direct-Expansion (DX) Ground-Source Heat Pumps	Table 5.2.13.1.
CSA	CAN/CSA-C802-94	Maximum Losses for Distribution, Power, and Dry-Type Transformers	7.2.3.1.(2)
CSA	CAN/CSA-C861-95	Performance of Compact Fluorescent Lamps and Ballasted Adapters	4.2.1.1.(3)
CTI	201(86)	Certification Standard for Commercial Water Cooling Towers	Table 5.2.13.1.
Government of Canada	LMB-EG-01-1986	Canadian Regulations Relating to the Inspection of Electricity and Gas Meters and Supplies	7.2.1.1.(1)
HI	1989	Testing and Rating Standard for Heating Boilers	Table 5.2.13.1.
NRC		Administrative Requirements for Use with the National Building Code of Canada	1.1.1.1.
NRC		Model National Energy Code of Canada for Houses 1997	1.1.2.1.(2)

Table 2.6.1.3. (Continued)

Issuing Agency	Document Number	Document Title	Code Reference
NRC		National Building Code of Canada 1995	1.1.2.3.(1) 1.1.2.3.(2) 1.1.3.2.(1) 2.2.1.1.(1) 3.2.1.1.(1) 3.2.2.3.(3)(f) 3.2.4.1.(1) 3.3.1.1.(3) 5.2.1.1.(1) 5.2.4.1.(1) 5.3.4.3.(2)(b)
NRC		National Plumbing Code of Canada 1995	6.2.1.1.(1)
NRC		Performance Compliance for Buildings: Specifications for Calculation Procedures for Demonstrating Compliance to the Model National Energy Code for Buildings Using Whole Building Performance, 1997	8.2.1.3.(1) 8.2.1.6.(1)
NRC		Trade-off Compliance for Buildings: Specifications for Calculation Procedures for Demonstrating Compliance to the Model National Energy Code for Buildings Using Trade-offs, 1997	3.4.3.3.(1)
SMACNA		HVAC Duct Construction Standards — Metal and Flexible, 1985	5.2.2.3.(2)
SMACNA		HVAC Air Duct Leakage Test Manual, 1985	5.2.2.4.(1)
TIAC		TIAC National Insulation Standards, 1992	5.2.2.5.(6) 5.2.4.3.(8)
UL	ANSI/UL 726-1990	Standard for Oil-Fired Boiler Assemblies	Table 5.2.13.1.
UL	UL 795-94 (1986, 1989)	Standard for Commercial-Industrial Gas Heating Equipment (including January 1996 Revisions)	Table 5.2.13.1.
U.S. Government		DOE Test Procedures, US Code of Federal Regulations, 10 CFR, Part 430, Subpart B, Appendix E, Uniform Test Method for Measuring the Energy Consumption of Water Heaters (55 FR 42619, October 17, 1990)	Table 6.2.2.1.
U.S. Government		National Appliance Energy Conservation Act of 1987 (Public Law 100-12)	



---

# Part 3

## Building Envelope

### Section 3.1. General

#### 3.1.1. Scope

##### 3.1.1.1. Application

1) Except as provided in Sentences (2) to (4), this Part applies to the components of a *building envelope* for all *buildings* within the scope of this Code.

2) This Part does not apply to *buildings* that are not equipped with space heating or cooling systems and have no provisions for future installation of such systems (see Appendix E).

3) This Part does not apply to *buildings* for which the maximum design rate of energy use for other than manufacturing or processing operations is less than 10 W/m<sup>2</sup> of *floor surface area* (see Appendix E).

4) The *authority having jurisdiction* may exempt a *building* or part of a *building* from some or all of the requirements of this Part where it can be shown that the nature and duration of the *occupancy* makes it impractical to apply these requirements (see Appendix E).

##### 3.1.1.2. Compliance

1) The mandatory provisions of Section 3.2. must be satisfied regardless of the compliance path chosen.

2) The prescriptive requirements of Section 3.3. must be satisfied unless the trade-offs permitted in Section 3.4. are used or the *building energy performance compliance path* described in Part 8 is followed.

### Section 3.2. Mandatory Provisions

#### 3.2.1. General

##### 3.2.1.1. Construction

1) Components of the *building envelope* shall be constructed in accordance with the appropriate provincial, territorial or municipal *building*

regulations or, in the absence of such regulations, or where components of the building envelope are not covered by such regulations, with the National Building Code of Canada.

##### 3.2.1.2. Continuity of Insulation

1) Except as provided in Sentences (2) to (10), interior *building* components that meet components of a *building envelope* and major structural members that partly penetrate the *building envelope* shall not break the continuity of the insulation and shall not increase the *overall thermal transmittance* at their projected area to more than that permitted in Section 3.3. (see Appendix E).

2) In calculating the *overall thermal transmittance* of assemblies for purposes of comparison with the prescriptive requirements in Section 3.3., the thermal bridging effect of closely-spaced, repetitive structural members such as studs and joists, and of ancillary members such as lintels, sills and plates, shall be accounted for as described in Appendices B and C.

3) In calculating the *overall thermal transmittance* of assemblies for purposes of comparison with the prescriptive requirements in Section 3.3., the thermal bridging effect of major structural members, such as columns and spandrel beams, that are parallel to the plane of the *building envelope* and partly penetrate that *building envelope* assembly need not be taken into account provided they do not increase the *overall thermal transmittance* at the projected area of the member to more than twice that permitted in Section 3.3. (see Appendix E).

4) In calculating the *overall thermal transmittance* of assemblies for purposes of comparison with the prescriptive requirements in Section 3.3., pipes, ducts, equipment with through-the-wall venting, packaged terminal air-conditioners or heat pumps, shelf angles, anchors and ties and associated fasteners, and other minor structural members that must completely penetrate the *building envelope* to perform their intended function need not be taken into account provided that the insulation is installed tight against the outline of the penetration.

### 3.2.2.1.

5) In calculating the *overall thermal transmittance* of assemblies for purposes of comparison with the prescriptive requirements in Section 3.3., major structural penetrations, such as floor and roof decks, balcony slabs, beams, girders, columns and other structural members that must completely penetrate the *building envelope* to perform their intended function need not be taken into account, provided that

- a) the insulation is installed tight against the outline of the penetration, and
- b) the sum of the cross-sectional areas at such major structural penetrations is limited to a maximum of 2% of the above-ground *building envelope* area.

6) Where a *foundation wall, firewall* or *party wall* built of concrete or masonry penetrates an exterior wall or insulated roof or ceiling and breaks the continuity of the *building envelope*, it shall be insulated

- a) on both of its sides inward or outward from the *building envelope* for a distance equal to 4 times the uninsulated thickness of the penetrating wall, and
- b) to an *overall thermal transmittance* no more than that required for the exterior wall.

7) Except as provided in Sentence (5), where a floor other than a floor on ground intersects an exterior wall, the intersection shall be insulated,

- a) for concrete slab construction, so that the thermal conductance of the insulation for the projected area of the floor shall be no more than twice the *overall thermal transmittance* permitted for the wall above the floor, and
- b) for all other floor constructions, to the same nominal level of insulation as the wall above the floor.

8) Except as provided in Sentence (5), where a roof other than an *attic-type* roof intersects an exterior wall, the intersection shall be insulated,

- a) for concrete slab construction, so that the thermal conductance of the insulation for the projected area of the roof shall be no more than twice the *overall thermal transmittance* permitted for the wall below the roof, and
- b) for all other roof constructions, to the same nominal level of insulation as the wall below the roof.

9) Where part of a component of a *building envelope* meets another part where the planes of insulation do not physically join, the 2 expanses of insulation shall be lapped for a distance of at least 4 times the distance separating the planes of insulation (see Appendix E).

10) Pipes and ducts that partly penetrate the *building envelope* shall be located on the warm side

of the insulation and shall not increase the *overall thermal transmittance* at the projected area of the pipe or duct to more than that permitted in Section 3.3.

11) Except as provided by Sentence (9), joints between components of the *building envelope*, such as expansion or construction joints, or joints between walls and doors or *fenestration*, shall be insulated in a manner that provides continuously across such joints an *overall thermal transmittance* no more than the higher of the 2 required for the components (see Appendix E).

### 3.2.2. Above-ground Components of the Building Envelope

#### 3.2.2.1. Roofs

1) Roof assemblies shall be considered to include all related structural framing.

2) A ceiling assembly shall be considered to constitute part of the related roof assembly and the entire assembly shall be insulated at either the ceiling level or the roof level or both, as dictated by good practice, in order to limit the *overall thermal transmittance* to that permitted.

3) For sloped *attic-type* roofs, the *overall thermal transmittance* may be increased to the extent made necessary by the roof slope and ventilation clearances, but in no case shall it exceed that permitted for the exterior wall below (see Appendix E).

#### 3.2.2.2. Walls

1) Wall assemblies shall be considered to include all related structural framing and perimeter areas of intersecting interior walls for purposes of determining the *overall thermal transmittance* permitted, but shall not include the perimeter areas where floor or roof slabs interrupt the wall construction (see Appendix E).

#### 3.2.2.3. Vestibules

1) Except as provided in Sentence (3), a door that separates *conditioned space* from the exterior shall be protected with an enclosed vestibule with all doors opening into and out of the vestibule equipped with self-closing devices.

2) Except for doors equipped with power operators in barrier-free entrances, vestibules required in Sentence (1) shall be designed so that, in passing through the vestibule, it is not necessary for a user to open the interior and exterior doors at the same time.

3) Vestibules are not required for exterior doors where

- a) the door is a revolving door,

- b) the door is used primarily to facilitate vehicular movement or material handling,
- c) the door is intended to be used as a service or emergency *exit* door only,
- d) the door opens directly from a *dwelling unit*,
- e) the door opens directly from a retail space less than 200 m<sup>2</sup> in area or from a space less than 150 m<sup>2</sup> for other uses, or
- f) the door is located in a *building* less than 5 storeys in *building height* in any area that has fewer than 3500 degree-days (°C) as listed in Appendix C of the National Building Code of Canada.

### 3.2.3. Building Assemblies in Contact with the Ground

#### 3.2.3.1. Roofs

1) The *effective thermal resistance* of below-ground roofs that are part of a *building envelope* and are less than 1.2 m below the exterior ground level shall be not less than that shown in Table A-3.2.3.1. of Appendix A for the administrative region considered and for the *principal heating source* for the *building* or part of the *building* enclosed by the component.

#### 3.2.3.2. Walls

1) Except as provided in Sentence (2), the *effective thermal resistance* of walls that are below the exterior ground level and are part of a *building envelope* shall be not less than that shown in Table A-3.2.3.1. of Appendix A for the administrative region considered and for the *principal heating source* for the *building* or part of the *building* enclosed by the component.

2) Where radiant heating cables, pipes or membranes are embedded in the surface of a wall that is below the exterior ground level and that separates *conditioned space* from the ground, that wall shall have an *effective thermal resistance* 20% greater than that required by Sentence (1) (see Appendix note E-3.3.1.1.(5)).

3) Insulation on walls in contact with the ground shall extend down

- a) to the level of the first floor encountered or to 2.4 m below the exterior ground level, whichever is less, but
- b) no less than 0.6 m below the exterior ground level, except as provided in Sentence (4).

(See Appendix E.)

4) Where the depth at the top of the footing is less than 0.6 m below the exterior ground level, wall insulation shall extend down to the top of the footing and the same level of insulation shall be

placed on the top or bottom surface of the floor for a distance not less than 1 m from the perimeter.

5) Where a wall in contact with the ground is constructed of hollow masonry and is insulated on its interior surface, the wall shall be insulated over its full height or its cells must be sealed at the level of the bottom part of the insulation (see Appendix E).

#### 3.2.3.3. Floors

(See Appendix E.)

1) The *effective thermal resistance* of floors separating *conditioned space* from the ground that are less than 0.6 m below *grade* and of all floors with imbedded heating ducts, cables or pipes shall be not less than that shown in Table A-3.2.3.1. of Appendix A for the administrative region considered and for the *principal heating source* for the *building* or part of the *building* enclosed by the component.

2) Floors on ground with no imbedded heating ducts, cables or pipes and required to be insulated shall have insulation placed on their top or bottom surface for a distance of not less than 1 m from their perimeter or over their full area as shown in Table A-3.2.3.1. of Appendix A for the administrative region considered and for the *principal heating source* for the *building* or part of the *building* enclosed by the component.

3) Floors on ground with imbedded heating ducts, cables or pipes and required to be insulated shall have insulation placed under their full bottom surface.

4) Except where the wall insulation is placed on the outside of the *foundation* wall and extends down to the level of the bottom of the floor, floors on ground required to be insulated shall have their insulation extended vertically around their perimeter so as to reduce heat losses from the slab to the *foundation* wall.

### 3.2.4. Airtightness

#### 3.2.4.1. General

1) Air barrier systems shall be provided in accordance with the appropriate provincial, territorial or municipal *building* regulations or, in the absence of such regulations or where air barrier systems are not covered by such regulations, with the applicable requirements of Part 5 and Section 9.25. of the National Building Code of Canada.

#### 3.2.4.2. Windows

1) Windows shall comply with the relevant federal, provincial or territorial appliance or equipment energy-efficiency act or, in the absence of such an act or where windows are not covered

### 3.2.4.3.

by such an act, with at least the A2 air leakage classification of CAN/CSA-A440-M, "Windows."

#### 3.2.4.3. Doors

1) Sliding door assemblies that are part of a *building envelope* shall comply with the relevant federal, provincial or territorial appliance or equipment energy-efficiency act or, in the absence of such an act or where doors are not covered by such an act, with at least the A2 air leakage classification of CAN/CGSB-82.1-M, "Sliding Doors."

2) Except as provided in Sentences (3) and (4), swing-type door assemblies that are part of a *building envelope* and open directly into a *dwelling unit* or an individually rented hotel or motel room or *suite* shall

- a) be designed to limit the rate of air leakage to no more than 0.82 L/s for each metre of door crack when tested in conformance with ASTM E 283, "Standard Test Method for Determining Rate of Air Leakage Through Exterior Windows, Curtain Walls, and Doors Under Specified Pressure Differences Across the Specimen," at a static air pressure difference of 75 Pa, or
- b) be weather-stripped on all edges.

3) Except for doors used primarily to facilitate the movement of vehicles or the handling of materials, door assemblies other than those described in Sentences (1), (2) and (4) that are part of a *building envelope* shall be designed to limit the rate of air leakage to no more than 17.0 L/s for each metre of door crack when tested in conformance with ASTM E 283, "Standard Test Method for Determining Rate of Air Leakage Through Exterior Windows, Curtain Walls, and Doors Under Specified Pressure Differences Across the Specimen," at a static air pressure difference of 75 Pa (see Appendix E).

4) Insulated steel doors prehung in a wood or steel *frame* shall conform to the air leakage requirements of CAN/CGSB-82.5-M, "Insulated Steel Doors."

5) Overhead doors that separate *conditioned space* from unconditioned space or the exterior space shall be weather-stripped on all edges.

6) Air curtains shall not be used in place of exterior doors.

#### 3.2.4.4. Fireplace Doors

1) Fireplaces shall be equipped with doors or enclosures to restrict air movement in the chimney when the fireplace is not in use.

## Section 3.3. Prescriptive Compliance

### 3.3.1. Above-ground Components of the Building Envelope

#### 3.3.1.1. Thermal Characteristics of Opaque Components of the Building Envelope

1) Except as provided in Sentences (3) to (5) and in Subsection 3.3.2., the *overall thermal transmittance* of above-ground *opaque components* of the *building envelope* shall be not more than that shown in Table A-3.3.1.1.(1) of Appendix A for the administrative region considered and for the *principal heating source* for the *building* or part of the *building* enclosed by the component (see Appendix E).

2) For the purpose of the requirements of Sentence (1), wall assemblies inclined less than 60° from horizontal are considered to be roof assemblies, and roof assemblies inclined 60° or more from horizontal are considered to be wall assemblies.

3) Where *solid masonry walls* are exempted in Table A-3.3.1.1.(3) of Appendix A and such walls are installed with no interior or exterior finish that incorporates insulation or creates a space that could accommodate insulation, such walls need not comply with the *overall thermal transmittance* requirements of Sentence (1) or with the continuity of insulation requirements of Article 3.2.1.2., provided the ungrouted cores of the masonry units are filled with insulation having a thermal conductivity no greater than 0.07 W/m·°C (see Appendix E regarding application of Part 5 of the National Building Code).

4) Portions of a *foundation* wall that are above ground, where the top of a *foundation* wall is less than 1.2 m above the adjoining ground level, may be insulated to the levels required by Sentence 3.2.3.2.(1).

5) Where radiant heating cables, pipes or membranes are embedded in the surface of an above-ground component of the *building envelope*, that component shall have an *overall thermal transmittance* no greater than 80% of that required by Sentence (1) (see Appendix E).

#### 3.3.1.2. Thermal Characteristics of Fenestration

1) Except as provided in Sentences (2) to (5) and in Subsection 3.3.2., the *overall thermal transmittance* of *fenestration*, including sliding glass doors but excluding swinging doors, shall be not

more than that shown in Tables A-3.3.1.2. of Appendix A for the administrative region considered and for the *principal heating source* of the *building* or part of the *building* enclosed by the component.

**2)** Where the *skylight-to-roof ratio* does not exceed 2%, *skylights* need not comply with Sentence (1) provided that

- they are at least double-glazed and their *frames*, if metallic, are provided with *thermal breaks*, or
- they have an *overall thermal transmittance* of not more than  $3.4 \text{ W/m}^2 \cdot ^\circ\text{C}$  (see Appendix E).

**3)** Automatic sliding glass doors and revolving doors need not comply with the *overall thermal transmittance* requirement of Sentence (1) (see Appendix E).

**4)** Glazing in overhead doors in *buildings* of *industrial occupancy* need not comply with the *overall thermal transmittance* requirement of Sentence (1).

**5)** The *overall thermal transmittance* of *fenestration* made of glass blocks shall not be more than 125% of that permitted in Sentence (1) for fixed glazing with *sash*.

### 3.3.1.3. Doors and Access Hatches

**1)** Except as provided in Sentences (4) and (5), swinging doors and integral transoms and sidelights that are part of a *building envelope* and are within the scope of CSA Standard A453, "Energy Performance Evaluation of Swinging Doors," shall have a label indicating an *overall thermal transmittance* of not more than that shown in Table 3.3.1.3. for the glazing category of the door (see Appendix E).

**Table 3.3.1.3.**  
Overall Thermal Transmittance for Swinging Doors  
Forming Part of Sentence 3.3.1.3.(1)

Glazing Category	Thermal Transmittance, $\text{W/m}^2 \cdot ^\circ\text{C}$
No glazing	2.1
Minimal glazing	2.2
1/2 glazing	2.5
Full glazing	2.7

**2)** Except as provided in Sentences (5) and (6), swinging doors and integral transoms and sidelights that are part of a *building envelope* and are not included in Sentence (1) shall have a nominal thermal transmittance of not more than  $1.3 \text{ W/m}^2 \cdot ^\circ\text{C}$ , not taking into account stiffeners or edge construction.

**3)** Overhead doors and access hatches that are part of a *building envelope* shall be insulated to a nominal thermal transmittance of not more than  $1.3 \text{ W/m}^2 \cdot ^\circ\text{C}$ , not taking into account stiffeners or edge construction.

**4)** Swinging glass doors with or without framing members on the door leaf need not comply with the *overall thermal transmittance* requirement of Sentences (1) and (3) (see Appendix E).

**5)** Storm doors need not comply with Sentences (1) and (2).

### 3.3.1.4. Effect of an Unconditioned Space

**1)** Where a component of the *building envelope* is protected by an enclosed unconditioned space, such as a sun porch, enclosed veranda or vestibule, the unconditioned enclosure may be considered to provide a thermal resistance of  $0.16 \text{ m}^2 \cdot ^\circ\text{C/W}$  or the equivalent of one layer of glass (see Appendix E).

## 3.3.2. Special Interior Temperature Conditions

### 3.3.2.1. Spaces Heated to Different Temperatures

**1)** Except in *dwelling units*, the *overall thermal transmittance* ( $U_I$ ) of *building* assemblies separating *conditioned spaces* that are intended to be heated to temperatures that differ by more than  $10^\circ\text{C}$  shall not be greater than that obtained with the formula

$$U_I = [(t_2 - t_0) / (t_2 - 0.5 \cdot t_1 - 0.5 \cdot t_0)] \cdot U$$

where

$t_1$  = indoor heating design temperature of the colder *conditioned space* ( $^\circ\text{C}$ ),

$t_2$  = indoor heating design temperature of the warmer *conditioned space* ( $^\circ\text{C}$ ),

$t_0$  = outdoor 2.5% January design temperature as specified in Sentence 2.2.1.1.(1) ( $^\circ\text{C}$ ), and

$U$  = *overall thermal transmittance* required in Sentences 3.3.1.1.(1), 3.3.1.2.(1) and 3.3.1.3.(1) ( $\text{W/m}^2 \cdot ^\circ\text{C}$ ).

(See Appendix E.)

### 3.4.1.1.

## Section 3.4. Trade-offs

(See Appendix note E-2.1.1.2.)

### 3.4.1. General

#### 3.4.1.1. Limitations

1) Trade-off calculations described in this Section shall be subject to the limitations described in Sentences (2) to (6).

2) The *overall thermal transmittance* of *opaque components* of the *building envelope* shall not be increased to more than 167% of the maximum *overall thermal transmittance* permitted in Section 3.3.

3) The *overall thermal transmittance* of components of the *building envelope* that have radiant heating cables, pipes or membranes embedded in them shall not be increased to more than the *overall thermal transmittance* permitted by Sentence 3.3.1.1.(5).

4) *Solid masonry walls* exempted under the provisions of Sentence 3.3.1.1.(3) shall not be the subject of trade-off calculations.

5) Doors covered in Sentences 3.3.1.3. (2) to (5) shall not be the subject of trade-off calculations.

6) Where construction techniques are used that are more thermally efficient than those permitted in the mandatory provisions of Section 3.2, the extra performance over the mandatory provisions shall not be used in trade-off calculations (see Appendix E).

#### 3.4.1.2. Treatment of Additions

1) In calculating trade-offs for an *addition*, it is not permitted to take into account improvements being made to existing components of the *building* (see also Sentence 2.2.2.8.(6)) (see Appendix E).

### 3.4.2. Simple Trade-offs

#### 3.4.2.1. Above-ground Components of the Building Envelope

1) Subject to the limitations of Article 3.4.1.1., the *overall thermal transmittance* of one or more above-ground components of the *building envelope* of a single *building* is permitted to be more than required in Section 3.3., provided the *overall thermal transmittance* of one or more other above-ground components of the *building envelope* of the same *building* is decreased, so that the sum of the areas of all above-ground components of the *building envelope* multiplied by their respective *overall thermal transmittances* is not more than it would be if all components were to comply with Section 3.3.

### 3.4.3. Computer-assisted Trade-offs

#### 3.4.3.1. Components of the Building Envelope

1) Subject to the limitations of Article 3.4.1.1. and Sentence (2), the thermal characteristics of one or more components of the *building envelope* of a single *building* may be less energy-efficient than otherwise required in this Part, provided it is demonstrated, using computer software conforming to Article 3.4.3.3., that the *building* will not use more energy than it would if all components were to comply with Section 3.3. (see Appendix E).

2) This type of trade-off calculation may only be carried out where

- a) all walls and windows of the *building* are vertical, and
- b) the total area of *skylights* is no greater than 2% of the total roof area, including *skylights*.

(See Appendix E.)

#### 3.4.3.2. Energy Source Adjustment Factor

1) When calculating the *building energy target* and the *annual adjusted energy consumption* of a *building* under Subsection 3.4.3., the consumption of energy from each source shall be adjusted by multiplying it by the *energy source adjustment factor* shown in Table D-1 of Appendix D for the administrative region considered.

#### 3.4.3.3. Compliance Software

1) Evaluation of compliance with Article 3.4.3.1. shall be done using computer software that conforms to specifications detailed in "Trade-off Compliance for Buildings: Specifications for Calculation Procedures for Demonstrating Compliance to the Model National Energy Code for Buildings Using Trade-offs," published by the Canadian Commission on Building and Fire Codes.

## **Section 3.5. Building Energy Performance Compliance**

(See Appendix note E-2.1.1.2.)

### **3.5.1. Alternate Compliance Path**

#### **3.5.1.1. Non-compliance with Prescriptive Requirements**

**1)** Where the *building envelope* does not comply with the requirements of Sections 3.3. or 3.4., it shall be demonstrated, using the procedures described in Part 8, Building Energy Performance Compliance, that the *building* will not use more energy than it would if the *building envelope* did comply with Sections 3.3. or 3.4.



# Part 4 Lighting

## Section 4.1. General

### 4.1.1. Scope

#### 4.1.1.1. Application

- 1) Except as provided in Sentence (2), this Part applies to lighting for *buildings* within the scope of this Code, including
  - a) lighting in interior spaces,
  - b) lighting of *building* exteriors and exterior *building* areas such as *exterior entrances*, *exterior exits*, and loading docks, and
  - c) lighting for grounds, parking and other exterior areas associated with the *building* site.
- 2) Lighting in a *building*, a part of a *building*, or certain exterior spaces associated with a *building* may be exempted from some or all requirements of this Part, where it can be shown that the nature of the *occupancy* makes it impractical to apply these requirements (see Appendix E).

#### 4.1.1.2. Compliance

- 1) The mandatory provisions of Section 4.2. must be satisfied regardless of the compliance path chosen.
- 2) The prescriptive requirements of Section 4.3. must be satisfied unless the *building* energy performance compliance path (Part 8) is followed.

## Section 4.2. Mandatory Provisions

### 4.2.1. Exterior Lighting Power

(See Appendix E.)

(See Section 4.3. for lighting in *storage garages*.)

#### 4.2.1.1. High-efficacy Exterior Lighting

- 1) Except as provided in Sentence (2), lamps for *exterior lighting* shall have an initial *luminous efficacy* of not less than 60 lm/W determined according to accepted good practice.

- 2) Lamps for *exterior lighting* need not comply with Sentence (1) where:
  - a) the lighting or spaces lit are identified in Table 4.2.1.1.,
  - b) power allowances are specified in Article 4.2.1.2., or
  - c) power limits are specified in Article 4.2.1.3.
- 3) Efficacy of compact fluorescent lamps shall be determined according to CAN/CSA-C861 "Performance of Compact Fluorescent Lamps and Ballasted Adapters."

Table 4.2.1.1.  
Exceptions to High Efficacy Requirement for Exterior Lighting  
Forming Part of Sentence 4.2.1.1.(2)

Category of Space	Lighting
Assembly spaces	Lighting for outdoor athletic facilities
Industrial spaces	Lighting of outdoor manufacturing and processing facilities
General	<i>Landscape lighting</i> Lighting of monuments Signs

#### 4.2.1.2. Entrance and Exit Lighting

- 1) Except as provided in Sentence (2), the connected *exterior lighting* power for *exterior entrances* and *exterior exits* shall not be greater than the total of the lighting power allowances provided in Table 4.2.1.2.

- 2) High-risk security *exterior entrances* and *exterior exits* identified either by local ordinances or regulations, or by security or safety officials, as requiring additional lighting need not comply with Sentence (1).

- 3) Trade-offs of *exterior entrance* and *exterior exit* lighting power allowances are permitted between *buildings* in multi-*building* facilities.

### 4.2.1.3.

**Table 4.2.1.2.**  
**Entrance and Exit Lighting Unit Power Allowances<sup>(1)</sup>**  
Forming Part of Sentence 4.2.1.2.(1)

Area Description	Allowance	
	W/lin m of threshold	W/m <sup>2</sup> of canopied area
<i>Exterior exit</i> with or without canopy	82.0	-
<i>Exterior entrance</i> without canopy	98.0	-
<i>Exterior entrance</i> with canopy		
<i>Assembly occupancy</i>	-	108
<i>Care or Detention occupancy</i>	-	43
<i>Residential occupancy</i>	-	43
<i>Business occupancy</i>	-	43
<i>Mercantile occupancy</i>	-	108
<i>Industrial occupancy</i>	-	43

**Notes to Table 4.2.1.2.:**

(1) Refer to Section 4.3., Table 4.3.2.1. and Table 4.3.3.4. for requirements relating to covered parking lot and *storage garage* lighting.

#### 4.2.1.3. Facade Lighting

**1)** The connected lighting power for *facade lighting* on any facade of a *building* shall be not greater than 2.4 W/m<sup>2</sup> of the facade surface area.

**2)** The facade surface area described in Sentence (1) is that delimited by the projection of the facade onto a vertical plane parallel to the facade.

#### 4.2.2. Exterior Lighting Controls

##### 4.2.2.1. Requirements

**1)** Except as provided in Sentence (2), *exterior lighting* shall be controlled by

- a) lighting schedule controllers,
- b) photocells, or
- c) a combination of lighting schedule controllers and photocells.

**2)** *Exterior lighting* need not be controlled as described in Sentence (1) where the lighting

- a) is intended for 24-h continuous use, or
- b) serves an outdoor sports facility (see Appendix E).

**3)** Lighting schedule controllers required in Sentence (1) shall be of the automatic type or otherwise capable of being programmed for 7 days and for seasonal daylight schedule variations.

**4)** All lighting schedule controllers shall be equipped with backup provisions to keep time during a power outage for at least 4 h.

#### 4.2.3. Interior Lighting Power

##### 4.2.3.1. Exit Signs

**1)** Power requirements for lighting units for *exit signs* shall not exceed 22 W per *exit sign*.

##### 4.2.3.2. Lighting Power in Dwellings

(See Section 4.3. for lighting of shared spaces in *buildings of residential occupancy*.)

**1)** Lighting within *dwelling units* is exempt from allowances and limits on *interior lighting* power (see Appendix E).

#### 4.2.4. Interior Lighting Controls

(See Appendix E.)

##### 4.2.4.1. Requirement for Controls

(See Appendix E.)

**1)** Except as permitted in Sentence (2), all *interior lighting* systems shall be provided with manual, automatic, or programmable controls.

- 2)** Controls are not required where
  - a) continuous lighting is required for safety or security purposes, or
  - b) lighting is emergency or *exit lighting*.

**3)** Each space enclosed by walls or ceiling-height *partitions* shall be provided with one or more controls that are capable of turning off all the hard-wired lights within the space.

**4)** At least one control shall be installed on each circuit.

##### 4.2.4.2. Controls for Night Lighting

(See Appendix E.)

**1)** Controls to permit lower lighting levels at night are required for office spaces

- a) 40 m<sup>2</sup> or more in area,
- b) enclosed by walls or ceiling-height *partitions*,
- c) in which the connected lighting is greater than 12 W/m<sup>2</sup>, and
- d) with more than one luminaire.

**2)** Where night lighting controls are required, at least one fixture shall be controlled separately from the remaining fixtures to provide a minimum level of light to allow safe passage across the space when the space is otherwise not being used.

**3)** The fixtures controlled to provide night lighting shall

- a) be located at a density of not more than one fixture for each area of 40 m<sup>2</sup>, and

- b) provide an average lighting level at the floor of not less than 10 lx.

(See also Sentence 4.2.4.3.(4).)

#### 4.2.4.3. Location of Controls

- 1) Except as provided in Sentences (2) and (3), lighting controls shall be
  - a) located next to the main entrance or entrances to the room or space whose lighting is controlled by those controls,
  - b) located such that there is a clear line of sight from the control to the area lighted, and
  - c) readily accessible to persons occupying or using the space.
- 2) Lighting controls may be centralized in remote locations where
  - a) controls are automatic,
  - b) controls are programmable, or
  - c) it is desirable, for security or safety reasons, that lighting be under the control of staff or *building* management (see Appendix E).
- 3) Where task lighting is installed other than in the ceiling, it shall be provided with switches located in or adjacent to the work station served.
- 4) Where one or more controls are installed as required by Article 4.2.4.2., those controls shall be located closest to the entrance to the room or space whose lighting is actuated by those controls (see Appendix E).
- 5) Except as provided in Sentence (6), where lighting controls are grouped, each control shall be identified to indicate the area controlled.
- 6) Controls need not comply with Sentence (5) where they are installed within a *dwelling unit*.

#### 4.2.4.4. Controls for Hotel Guest Rooms

- 1) In hotels and motels, guest rooms and *suites* shall be provided with one or more master switches at the main entry door to each guest room or *suite*, or each room within a *suite*, to turn off all permanently wired lighting fixtures and switched receptacles, except those located in bathrooms (see Appendix E).

### 4.2.5. Ballasts

#### 4.2.5.1. Fluorescent Lamp Ballasts

- 1) Except as provided in Sentence (3), fluorescent lamp ballast types within the scope of CAN/CSA-C654-M, “Fluorescent Lamp Ballast Efficacy Measurements,” shall conform to that standard.

- 2) Except as provided in Sentence (3), electronic fluorescent lamp ballasts within the scope of ANSI C82.11, “High-Frequency Fluorescent Lamp Ballasts,” but not within the scope of CAN/CSA-C654-M, “Fluorescent Lamp Ballast Efficacy Measurements,” shall conform to the ANSI C82.11 standard.

- 3) Fluorescent lamp ballasts shall comply with the relevant federal, provincial or territorial appliance or equipment energy-efficiency act.

### 4.2.6. Documentation

#### 4.2.6.1. System Design and Operation

- 1) A statement of design intent and operational recommendations shall be provided to enable the system to be operated in an efficient manner.
- 2) The statement required in Sentence (1) shall include
  - a) a single-line diagram of the lighting control system showing the location of each zone and associated switches,
  - b) a luminaire schedule indicating lamp and ballast replacement, and
  - c) manufacturers’ operation and maintenance instructions for installed automatic lighting controls.

(See Appendix E.)

## Section 4.3. Prescriptive Compliance

(See Appendix E.)

### 4.3.1. Interior Connected Lighting Power

#### 4.3.1.1. Limits

- 1) The total interior connected lighting power (ICLP), as determined in Article 4.3.1.2., shall not exceed the value of the interior lighting power allowance (ILPA) as determined either by *building* type (see Subsection 4.3.2.) or by space function (see Subsection 4.3.3.).

#### 4.3.1.2. Calculation

(See Appendix E.)

- 1) Except as provided in Sentences (3) and (4), ICLP shall be calculated using the following equation:

$$\text{ICLP} = \text{the sum of the CLPs for all luminaires that provide interior lighting}$$

### 4.3.2.1.

where

ICLP = interior connected lighting power, and  
 CLP = connected lighting power for each luminaire, including ballasts and transformers required between the control and the lamp.

- 2) The determination of ICLP shall
  - a) include connected lighting power for both permanently installed *interior lighting* and supplemental or task-related *interior lighting* provided by movable or plug-in luminaires (see Appendix E), and
  - b) reflect the selection of types and numbers of luminaires in accordance with good lighting design practice, taking into account the intended use of the space lit by the luminaires.

(See Appendix E.)

3) The following types of lighting shall not be included in the calculation of ICLP:

- a) lighting within *dwelling units*, and
- b) lighting for enclosed display cases in retail facilities.

4) Lighting for functions, spaces or equipment need not be included in the calculation of ICLP where

- a) the functions, spaces or equipment are identified in Table 4.3.1.2., or
- b) it can be shown that inclusion will adversely affect the intended functions, or the use of the space or equipment.

### 4.3.2. Calculation of Interior Lighting Power Allowance by Building Type

(See Appendix E.)

#### 4.3.2.1. Interior Lighting Power Allowance by Building Type

1) Calculation of interior lighting power allowance by *building* type (ILPA<sub>BT</sub>) as provided in this Subsection may be applied only where

- a) the ILPA is being determined for an entire *building*, and
- b) the *building* type is identified in Table 4.3.2.1.

(See Appendix E.)

**Table 4.3.1.2.**  
**Exclusions from Calculation of Interior Connected Lighting Power**

Forming Part of Sentence 4.3.1.2.(4)

Category of space	Exclusions
Assembly spaces	<p>Lighting for theatrical productions, television broadcasting, audio-visual presentations</p> <p>Lighting for those portions of entertainment facilities such as stage areas in hotels, nightclubs, discos and casinos where lighting is an essential technical element of the function performed</p> <p>Display lighting for art exhibits, or displays in galleries or museums</p>
Care or detention spaces	Specialized lighting for medical, dental or research purposes
Business and personal services spaces	Specialized lighting for medical, dental or research purposes
Mercantile spaces	Storefront, exterior, enclosed display windows in retail facilities
Industrial spaces	Lighting to be used solely for indoor plant growth during the hours of 22:00 to 06:00
General	<p>Lighting in high risk security areas or in any area identified by local ordinances or regulations, or by safety or security officials, as requiring additional lighting</p> <p>Spaces specifically designed for the visually or hearing impaired, or for senior citizens</p> <p>Lighting for signs</p> <p>Emergency lighting that is automatically OFF during normal building operation</p>

**Table 4.3.2.1.**  
**Lighting Power Density by Building Type (LPD<sub>BT</sub>), W/m<sup>2</sup>**  
 Forming Part of Article 4.3.2.1.

Building or Area Type	Gross Lighted Area of Building or Area <sup>(1)</sup> , m <sup>2</sup>					
	0 to 200	201 to 1000	1001 to 2500	2501 to 5000	5001 to 25000	>25000
Assembly						
Food service						
Fast food/cafeteria	16.2	14.8	14.4	14.2	14.1	14.0
Leisure dining/bar	23.7	20.6	18.4	16.8	15.7	15.1
Schools						
Pre-school/elementary	19.4	19.4	18.5	17.8	16.9	16.2
Junior high/high school	20.4	20.4	20.2	19.7	18.9	18.3
Technical/vocational	25.8	25.1	23.4	21.6	19.8	18.3
Business and Personal Services						
Offices	20.4	19.5	18.5	17.8	16.9	16.2
Service establishment	29.1	25.5	22.4	20.7	19.4	18.3
Mercantile						
Retail	35.5	33.2	30.9	26.9	24.5	22.6
Mall concourse						
Multi-store service	17.2	17.0	16.4	15.7	15.4	15.1
Industrial						
Storage garages	3.2	3.0	2.6	2.4	2.3	2.2
Warehouse/storage	8.6	7.1	6.0	5.2	4.6	4.3

**Notes to Table 4.3.2.1.:**

(1) See Appendix E.

**2)** Where the *building* is of a type other than those listed in Table 4.3.2.1., the ILPA shall be calculated by the space function method described in Subsection 4.3.3.

**3)** Except as provided in Sentence (5), ILPA calculations shall be based on the primary use for which the *building* is intended.

**4)** Except as provided in Sentence (5), ILPA shall be calculated using the following equation:

$$\text{ILPA} = \text{LPD}_{\text{BT}} \cdot \text{GLA}$$

where

ILPA = interior lighting power allowance (W),

LPD<sub>BT</sub> = lighting power density for the *building* type (W/m<sup>2</sup>), as provided in Table 4.3.2.1., and

GLA = gross lighted area (m<sup>2</sup>).

**5)** If 10% or more of the *gross lighted area* of the *building* can be classified as being of a *building*

type other than the principal type for the *building*, then

- a) the lighting power for each of these areas shall be calculated based on
  - i) the LPD<sub>BT</sub> of the related *building* types (see Table 4.3.2.1.), and
  - ii) the *gross lighted area* of those areas, and
- b) the values derived from Clause (a) shall be added together to obtain the ILPA for the total *building*.

(See Appendix E.)

### 4.3.3.1.

#### 4.3.3. Calculation of Interior Lighting Power Allowance by Space Function

(See Appendix E.)

##### 4.3.3.1. Interior Lighting Power Allowance by Space Function

1) Interior lighting power allowance by space function ( $ILPA_{SF}$ ) shall be calculated using the following equation:

$$ILPA = \text{the sum of } LPA_{SF} \text{ for all listed spaces}$$

where

$ILPA$  = interior lighting power allowance (W), and

$LPA_{SF}$  = lighting power allowance by space function (W), determined as provided in Article 4.3.3.2.

##### 4.3.3.2. Lighting Power Allowance by Space Function

1) The lighting power allowance by space function ( $LPA_{SF}$ ) shall be determined based on the function of each space.

2) Except as provided in Articles 4.3.3.6. and 4.3.3.7., the lighting power allowance of each interior space shall be determined in accordance with the following equation:

$$LPA_{SF} = A \cdot LPD_{SF} \cdot AF$$

where

$LPA_{SF}$  = lighting power allowance for the space function (W),

$A$  = area of the space ( $m^2$ ), as provided in Article 4.3.3.3.,

$LPD_{SF}$  = lighting power density for the space function ( $W/m^2$ ), as provided in Article 4.3.3.4., and

$AF$  = area factor of the space, as provided in Article 4.3.3.5.

##### 4.3.3.3. Determination of Area

1) The area ( $A$ ) shall be calculated from the inside dimensions of the space.

##### 4.3.3.4. Determination of Lighting Power Density by Space Function

1) Except as provided in Sentence (2), the lighting power density by space function ( $LPD_{SF}$ ) shall be selected from Table 4.3.3.4.

Table 4.3.3.4.  
Lighting Power Densities by Space Function  
Forming Part of Sentence 4.3.3.4.(1)

Space Function	$LPD_{SF}$ , $W/m^2$
Assembly Spaces	
Art galleries	
General exhibition space	20.4
Auditoria	17.2
Churches and similar places of worship	
Preaching and sermon/choir	29.1
Worship/congregational	26.9
Conference centres	
Banquet, multi-purpose rooms	25.8
Conference, meeting rooms	19.4
Exhibition halls	28.0
Lecture halls/Classrooms	21.5
Libraries	
Audio-visual	11.8
Card file and cataloguing	17.2
Reading area	20.4
Stack area <sup>(1)</sup>	
Stack mounted lighting	16.2
Ceiling space lighting	32.3
Licensed beverage establishments	
Kitchen	15.1
Seating area	26.9
Museums	
General exhibition space	20.4
Passenger stations and depots	
Baggage area	10.8
Concourse/main thruway	9.7
Ticket counter	26.9
Waiting and lounge area	12.9
Restaurants	
Fast food/Cafeteria food pick-up and seating area <sup>(2)</sup>	14.0
Kitchen	15.1
Leisure dining, seating area <sup>(2)</sup>	26.9
Sports venues	
Seating area (all sports)	4.3
Badminton	
Club	5.4
Tournament	8.6
Basketball/Volleyball	
College	14.0
Intramural	8.6
Professional	20.4

Table 4.3.3.4. (Continued)

Space Function	LPD <sub>SF</sub> , W/m <sup>2</sup>
Bowling	
Approach area	5.4
Lanes	10.8
Boxing and wrestling (platform)	
Amateur	25.8
Professional	51.7
Gymnasium	
General exercising and recreation only	10.8
Handball/Racquetball/Squash	
Club	14.0
Tournament	28.0
Hockey, ice	
Amateur	14.0
College or professional	28.0
Skating rink	
Exhibition professional	28.0
Recreational	6.5
Swimming	
Exhibition	16.2
Recreational	9.6
Underwater	10.8
Tennis	
Club/College (Class II)	20.4
Professional (Class I)	28.0
Recreational (Class III)	14.0
Tennis, table	
Club	10.8
Tournament	17.2
Theatres	
Lobbies	10.8
Motion picture	16.2
Opera houses	16.2
Other, including experimental theatres	16.2
<b>Business and Personal Services Spaces</b>	
Bank	
Banking activity area	30.1
Customer queuing, waiting area (see also office categories below)	11.8
Barber and beauty parlour	21.5
Computer/Office equipment	22.6
Conference/Meeting room	19.4
Filing, inactive	10.8
Laundry (self-serve)	
Ironing and sorting	14.0
Washing	9.7
Mail room	19.4

Table 4.3.3.4. (Continued)

Space Function	LPD <sub>SF</sub> , W/m <sup>2</sup>
Office category 1	
Accounting	22.6
Drafting	23.0
Reading, typing and filing	19.4
Office category 2	
Accounting	25.8
Drafting	31.2
Reading, typing and filing	20.4
Office category 3	
Accounting	29.1
Drafting	36.7
Reading, typing and filing	23.7
Post office	
Lobby	11.8
Sorting and mailing	22.6
<b>Care or Detention Spaces</b>	
Hospitals, nursing homes	
Corridor	14.0
Dental suite	
Examination/treatment	24.8
General area	22.6
Emergency	24.7
Laboratory	20.4
Lounge/waiting room	9.7
Medical supplies	25.8
Nursery	21.5
Nurse station	22.6
Occupational therapy/physical therapy	17.2
Patient room	15.1
Pharmacy	18.3
Radiology	22.6
Surgical and obstetrical suites	
General area	22.6
Operating room	75.3
Recovery	24.8
Jails, penitentiaries, police stations, prisons	
Jail cell	8.6
<b>Residential Spaces</b>	
Dormitories	
Bedroom	11.8
Bedroom with study	15.1
Recreation, lounge	7.5
Study hall	19.4

### 4.3.3.4.

Table 4.3.3.4. (Continued)

Space Function	LPD <sub>SF</sub> , W/m <sup>2</sup>
<b>Hotels</b>	
Banquet, multi-purpose rooms	25.8
Bathroom/powder rooms	12.9
Conference, meeting rooms	19.4
Guest rooms	15.1
Lobbies	20.4
Public areas	12.9
Reception desks	25.8
<b>Industrial Spaces</b>	
Fire department	
Fire engine room	7.5
Inspection/Restoration	
Museum artifacts	42.0
Laboratory	24.8
Laundry (non-self-serve)	
Ironing and sorting	14.0
Washing	9.7
Service station/Auto repair	3.2
Shop	
Carpentry	24.8
Electrical/electronic	26.9
Machinery	26.9
Painting	17.2
Welding	12.9
Storage garage <sup>(2)</sup>	10.8
Storage and warehouse	
Active storage, bulky, general	3.2
Active storage, fine, museum artifacts	7.5
Inactive storage, general	3.2
Inactive storage, museum artifacts	6.5
Material handling	10.8
<b>Mercantile Spaces</b>	
Mall concourse	15.1
Retail establishments <sup>(2)</sup>	
Jewellery merchandising	53.8
General merchandising	35.5
Fine merchandising	34.4
Mass merchandising	33.4
Food and miscellaneous	30.1
Service establishments	29.1
Retail support areas	
Dressing/Fitting rooms	15.1
Tailoring	22.6

Table 4.3.3.4. (Continued)

Space Function	LPD <sub>SF</sub> , W/m <sup>2</sup>
<b>General Spaces</b>	
Corridor	8.6
Electrical/Mechanical equipment room	
General	7.5
Control rooms	16.2
Lobby (general)	
Atrium (multi-storey)	
First 3 floors	7.5
Each additional floor	2.2
Elevator lobbies	8.6
Reception and waiting	10.8
Locker room and shower	8.6
Stair	
Active traffic	6.5
Emergency exit	4.3
Toilet and washroom	8.7
Unlisted space	2.2

**Notes to Table 4.3.3.4.:**

- (1) Appropriate light levels on vertical surfaces of library stacks would be difficult to meet with 16.2 W/m<sup>2</sup> power level when lighting is ceiling-mounted. An alternate level of 32.3 W/m<sup>2</sup> is provided for ceiling lighting.
- (2) See Appendix E.

**2)** For areas or activities other than those given in Table 4.3.3.4., values shall be selected for similar areas or activities.

**3)** LPD<sub>SF</sub> for an office category shall apply where not less than 90% of all work stations are enclosed by *partitions* at least the height specified for the category in Sentences (4), (5) and (6).

- 4)** LPD<sub>SF</sub> for office category 1 shall apply to:
  - a) offices enclosed by walls or ceiling-height *partitions*,
  - b) open-plan offices without *partitions*,
  - c) offices less than 85 m<sup>2</sup>, and
  - d) open-plan offices where the distance between the top of the *partitions* and the ceiling is more than 1370 mm.

- 5)** LPD<sub>SF</sub> for office category 2 shall apply to open plan offices
  - a) that are 85 m<sup>2</sup> or larger, and
  - b) where the distance between the top of the *partitions* and the ceiling is between 1070 mm and 1370 mm.

- 6)** LPD<sub>SF</sub> for office category 3 shall apply to open plan offices
  - a) that are 85 m<sup>2</sup> or larger, and

- b) where the distance between the top of the partitions and the ceiling is less than 1070 mm.

7)  $LPD_{SF}$  for retail establishments shall apply to all lighting, including accent and display lighting, installed in purchasing and circulation areas, but excluding lighting installed in display cases.

#### 4.3.3.5. Determination of Area Factor

1) Except as provided in Sentences (4) and (5), the area factor (AF) shall be determined from the following equation:

$$AF = 0.2 + 0.8(1/0.9^n)$$

where

$$n = \frac{10.21(CH-0.76)}{\sqrt{A}} - 1,$$

CH = ceiling height, m, and  
A = area of space (m<sup>2</sup>);

and,

if AF < 1.0, then AF = 1.0, and

if AF > 1.8, then AF = 1.8

(See Appendix E.)

2) Rooms of identical ceiling height and activity may be evaluated as a group.

3) The area factor of a group of rooms shall be determined from the average area of these rooms.

4) The area factor shall be 1.55 for spaces in office category 1.

5) The area factor shall be 1.0 for

- a) corridors,
- b) electrical and mechanical equipment rooms,
- c) spaces in office categories 2 and 3, and
- d) indoor athletic areas.

#### 4.3.3.6. Special Spaces and Activities

1) For rooms serving multiple functions such as hotel banquet or meeting rooms and office conference or presentation rooms, an adjustment factor of 1.3 times the  $LPD_{SF}$  may be used if a supplementary system with independent controls is installed.

2) In rooms containing multiple simultaneous activities, such as a large general office having separate accounting and drafting areas within the same room, the  $LPA_{SF}$  for the rooms shall be the weighted average of the activities in proportion to the areas being served.

3) The area of activity of indoor sports shall be considered as extending 3 m beyond the playing boundaries of the sport, but not exceeding the total

floor area of the indoor sports space minus the spectator seating area (see Appendix E).

## Section 4.4. Building Energy Performance Compliance

### 4.4.1. Alternate Compliance Path

#### 4.4.1.1. Non-compliance with Prescriptive Requirements

1) Where the lighting system does not comply with the requirements of Section 4.3., it shall be demonstrated, according to the procedures described in Part 8, Building Energy Performance Compliance, that the building will not use more energy than it would if the lighting system did comply with Section 4.3.



---

# Part 5 Heating, Ventilating and Air-conditioning Systems

## Section 5.1. General

### 5.1.1. Scope

#### 5.1.1.1. Application

**1)** Except as permitted in Sentences (2) and (3), and except for systems and equipment used exclusively for the control of smoke in the event of a fire, this Part applies to heating, ventilating and air-conditioning systems and equipment.

**2)** The *authority having jurisdiction* may exempt a heating, ventilating or air-conditioning system or part of a system from some or all of the requirements of this Part, where it can be shown that the nature of the *occupancy* or the type of heating, ventilating or air-conditioning equipment used makes it impractical to apply these requirements (see Appendix E).

**3)** This Part does not apply to the existing components of systems that are extended to serve *additions*.

#### 5.1.1.2. Compliance

**1)** The mandatory provisions of Section 5.2. must be satisfied regardless of the compliance path chosen.

**2)** The prescriptive requirements of Section 5.3. must be satisfied unless the *building* energy performance compliance path described in Part 8 is followed.

## Section 5.2. Mandatory Provisions

### 5.2.1. Equipment Sizing

#### 5.2.1.1. Load Calculations

**1)** Heating, ventilating and air-conditioning systems shall be sized to meet the needs of the *conditioned spaces* in which they are installed, in accordance with the relevant provincial, territorial or municipal regulations or, in the absence of such regulations, or where heating, ventilating and air-conditioning systems are not covered by such

regulations, with the National Building Code of Canada (see Appendix E).

### 5.2.2. Air Distribution Systems

#### 5.2.2.1. Design and Installation of Ducts

**1)** Ducts shall be designed and installed in accordance with the relevant provincial, territorial or municipal *building* regulations or, in the absence of such regulations, or where ducts are not covered by such regulations, with the National Building Code of Canada (see Appendix E).

#### 5.2.2.2. Provision for Balancing

**1)** All air distribution systems shall be designed so that they can be balanced (see Appendix E).

#### 5.2.2.3. Duct Sealing

**1)** Air handling ducts and *plenums* forming part of a heating, ventilating or air-conditioning system shall be

- a) constructed, installed and sealed in accordance with Sentence (2), or
- b) tested to meet the requirements of Article 5.2.2.4.

**2)** Except as provided in Sentences (3) to (5), all air-handling ducts and *plenums* forming part of a heating, ventilating or air-conditioning system shall be constructed, installed and sealed as described in the SMACNA “HVAC Duct Construction Standards — Metal and Flexible,” and in accordance with Table 5.2.2.3. (see Appendix E).

**3)** *Return ducts* located within *conditioned space* or in spaces used as return air *plenums* need not comply with Sentence (2).

**4)** Except for *supply ducts* located upstream of zone coils, mixing boxes, variable-air-volume boxes and diffusers with integral variable-air-volume controls, *supply ducts* located within the *conditioned space* to which they supply air need not comply with Sentence (2) (see Appendix E).

**5)** Sealing tape shall not be used as the primary sealant where such ducts are designed to operate at static pressures of 250 Pa or greater.

## 5.2.2.4.

**Table 5.2.2.3.**  
**Sealing of Ducts**  
Forming Part of Sentence 5.2.2.3.(2)

Static Pressure Class <sup>(1)(2)</sup>	Seal Class <sup>(1)</sup>
≤ 2	C
> 2 and < 4	B
≥ 4	A

**Notes to Table 5.2.2.3.:**

- (1) In accordance with SMACNA HVAC Duct Construction Standards.  
(2) Refers to SMACNA Static Pressure Class (inches, water gauge), not the actual design static pressure; these classes include both negatively and positively pressurized ducts.

### 5.2.2.4. Duct Leakage Testing

**1)** Where ducts are not constructed, installed and sealed in accordance with Sentence 5.2.2.3.(2), they shall be leakage-tested in conformance with the SMACNA “HVAC Air Duct Leakage Test Manual” and shall meet the requirements of Sentence (2) (see Appendix E).

**2)** For ducts tested in accordance with Sentence (1), the maximum permitted leakage shall be calculated as follows:

$$L_{\max} = (C_L \cdot (P)^{0.65}) / 720$$

where:

- $L_{\max}$  = maximum permitted leakage, L/s/100 m<sup>2</sup> of duct surface area,  
 $C_L$  = leakage class from Table 5.2.2.4., and  
 $P$  = maximum operating static pressure (Pa).

**Table 5.2.2.4.**  
**Leakage Class ( $C_L$ )**  
Forming Part of Sentence 5.2.2.4.(2)

Shape	Maximum Operating Static Pressure, Pa		
	< 500	500-750	> 750
Leakage Class, $C_L$			
Rectangular	24	12	6
Round	12	6	3

### 5.2.2.5. Duct and Plenum Insulation

**1)** Except as provided in Sentences (2) to (5), all air-handling ducts, *plenums* and run-outs forming part of a heating, ventilating, or air-conditioning system shall be thermally insulated in accordance with Table 5.2.2.5.

**Table 5.2.2.5.**  
**Insulation of Ducts**  
Forming Part of Sentence 5.2.2.5. (1)

Temperature Difference, <sup>(1)</sup> °C	Min. Thermal Resistance for Ducts and Plenums, m <sup>2</sup> ·°C/W	Min. Thermal Resistance for Run-outs, <sup>(2)</sup> m <sup>2</sup> ·°C/W
< 5	0	0
5 to 22	0.58	0.58
> 22	0.88	0.58

**Notes to Table 5.2.2.5.:**

- (1) The temperature difference at design conditions between the space within which the duct is located and the design air temperature of the air carried by the duct. Where a duct is used for both heating and cooling purposes, the larger temperature difference shall be used.  
(2) Ducts not exceeding 3 m in length connecting to terminal grilles or diffusers.

**2)** *Exhaust ducts, return ducts and plenums* located within *conditioned space* need not comply with Sentence (1).

**3)** Ducts and *plenums* located within *conditioned space* in a *dwelling unit* and serving only that *dwelling unit* need not comply with Sentence (1).

**4)** Except for relief and outside air ducts and except as provided in Sentence (5), all air-handling ducts and *plenums* forming part of a heating, ventilating, or air-conditioning system — and located outside the *building envelope* — shall be insulated to the same level as required for walls in Subsection 3.3.1.

**5)** Factory-installed *plenums*, or ducts furnished as a part of equipment tested and rated in accordance with Subsection 5.2.13., need not comply with Sentences (1) and (4), provided they are insulated to a thermal resistance no less than 0.58 m<sup>2</sup>·°C/W.

**6)** Insulation material required in Sentence (1) shall be installed in accordance with good practice such as described in “TIAC National Insulation Standards,” published by the Thermal Insulation Association of Canada.

### 5.2.2.6. Protection of Duct Insulation

**1)** Insulation on cold-air *supply ducts* shall be provided with vapour barrier protection to prevent condensation, where the surface temperature of the duct is below the dew point of the air surrounding the duct.

**2)** Duct insulation located in areas where it may be subject to mechanical damage or weathering shall be protected.

### 5.2.3. Air Intake and Outlet Dampers

#### 5.2.3.1. Required Dampers

1) Except as provided in Sentences (2) to (4), every duct or opening intended to discharge air from a *conditioned space* to the outdoors or to unconditioned space, and every outdoor air intake duct or opening, shall be equipped with a motorized damper.

2) Where dampers are not permitted by other regulations, air intakes and outlets need not comply with Sentence (1).

3) Air intakes and outlets serving systems required to operate continuously need not comply with Sentence (1).

4) Where the duct or opening does not exceed 0.08 m<sup>2</sup> in cross-sectional area, air intake dampers required in Sentence (1) may be manually operated and air outlet dampers required by Sentence (1) may consist of gravity or spring-operated backflow dampers.

#### 5.2.3.2. Type and Location of Dampers

1) Except as provided in Sentences (3) and (4), dampers required by Article 5.2.3.1. shall be located as near as possible to the plane of the *building envelope* and shall be designed to close automatically when the system is not in operation.

2) Motorized dampers required in Article 5.2.3.1. shall be designed so that air flow with the damper in the closed position does not exceed 15 L/s for each square metre of cross-sectional area at a pressure difference of 250 Pa, when tested in accordance with AMCA Standard 500, "Test Methods for Louvers, Dampers and Shutters."

3) Dampers required in Article 5.2.3.1. may be located inboard of the *building envelope*, provided the portion of the duct between the damper and *building envelope* is insulated in conformance with the requirements in Sentence 5.2.2.5.(4) for ducts located outdoors.

4) Dampers in air intakes and outlets serving air heating or cooling equipment located outside of the *building envelope* may be located within the equipment.

### 5.2.4. Piping for Heating and Cooling Systems

#### 5.2.4.1. Design and Installation of Piping

1) Piping shall be designed and installed in accordance with the relevant provincial, territorial

or municipal building regulations or, in the absence of such regulations, or where piping is not covered by such regulations, with the National Building Code of Canada.

#### 5.2.4.2. Provision for Balancing

1) All hydronic systems shall be designed so that they can be balanced (see Appendix E).

#### 5.2.4.3. Piping Insulation

1) Except as provided in Sentences (2) to (6), all piping shall be thermally insulated in accordance with Table 5.2.4.3.

2) Except for suction-line piping of direct expansion systems, piping located within *conditioned space* in a *dwelling unit* and that serves only that *dwelling unit* need not comply with Sentence (1).

3) All piping forming part of a heating, ventilating or air-conditioning system and located outside the *building envelope* shall be insulated to the level specified in Table 5.2.4.3. for heating system pipes with fluid design operating temperatures above 177°C.

4) Piping that conveys fluids with a design operating temperature range of between 13°C and 40°C need not comply with Table 5.2.4.3.

5) Where pipe insulation has a thermal conductivity of more than the range given in Table 5.2.4.3., the thickness given in the table shall be increased by the ratio  $u_1/u_2$ , where  $u_1$  is the higher end of the Conductivity Range for the operating temperature and  $u_2$  is the measured thermal conductivity of the insulation at the Mean Rating Temperature.

6) Where pipe insulation has a thermal conductivity of less than the range given in Table 5.2.4.3., the thickness given in the table shall be decreased by the ratio  $u_1/u_2$ , where  $u_1$  is the lower end of the Conductivity Range for the operating temperature and  $u_2$  is the measured thermal conductivity of the insulation at the Mean Rating Temperature.

7) The thermal conductivity of pipe insulation at the Mean Rating Temperature shall be determined in conformance with ASTM C 335, "Standard Test Method for Steady-State Heat Transfer Properties of Horizontal Pipe Insulation."

8) Insulation material required in Sentence (1) shall be installed in accordance with good practice such as described in "TIAC National Insulation Standards," published by the Thermal Insulation Association of Canada.

## 5.2.4.4.

**Table 5.2.4.3.**  
**Minimum Pipe Insulation Thickness, mm**  
Forming Part of Sentence 5.2.4.3.(1)

Design Operating Temperature Range, °C	Insulation Conductivity		Nominal Pipe Diameter, inches (mm)				
	Conductivity Range, W/m·°C	Mean Rating Temperature, °C	Runouts <sup>(1)</sup> ≤ 2 (51)	≤ 1 (25.4)	1 1/4 to 2 (32 to 51)	2 1/2 to 4 (64 to 102)	≥ 5 (127)
<b>Heating Systems (Steam, Steam condensate and Hot water)</b>							
> 177	0.046-0.049	121	38.1	63.5	63.5	76.2	88.9
122-177	0.042-0.045	93	38.1	50.8	63.5	63.5	88.9
94-121	0.039-0.043	65	25.4	38.1	38.1	50.8	50.8
61-93	0.036-0.042	52	25.4	25.4	25.4	38.1	38.1
41-60	0.035-0.040	38	25.4	25.4	25.4	25.4	38.1
<b>Cooling Systems (Chilled water, Brine and Refrigerant)<sup>(2)</sup></b>							
5-13	0.033-0.039	24	25.4	25.4	25.4	25.4	25.4
< 5	0.033-0.039	24	25.4	25.4	38.1	38.1	38.1

### Notes to Table 5.2.4.3.:

(1) Runouts to individual terminal units not exceeding 3.7 m in length.

(2) The required minimum thicknesses do not consider water vapour transmission and condensation. Additional insulation, vapour barriers, or both, may be required to limit water vapour transmission and condensation.

### 5.2.4.4. Protection of Piping Insulation

**1)** Insulation on chilled fluid piping shall be provided with vapour barrier protection to prevent condensation, where the surface temperature of the pipe is below the dew point of the air.

**2)** Piping insulation located in areas where it may be subject to mechanical damage or weathering shall be protected.

required for the proper operation of primary equipment serving the system, such as chillers and *boilers*,

- b) to systems with a single control valve, or
- c) to systems that include controls to reset the fluid supply temperature based on either outdoor temperature or system loads.

### 5.2.5. Pumping System Design

#### 5.2.5.1. Application

**1)** This Subsection applies to all heating, ventilating or air-conditioning pumping systems with total pump system motor power of 7.5 kW or greater.

#### 5.2.5.2. Variable-Flow Pumping Systems

**1)** Except as provided in Sentence (2), pumping systems that serve control valves designed to modulate or to open and close in steps as a function of load shall be designed for variable fluid flow and shall be capable of reducing system flow to 50% of design flow or less (see Appendix E).

- 2)** Sentence (1) does not apply
  - a) to systems where a minimum flow greater than 50% of the design flow is

### 5.2.6. Equipment Installed Outdoors

#### 5.2.6.1. Manufacturer's Designation

**1)** Equipment installed outdoors or in an unconditioned space shall be designated by the manufacturer for such installation.

### 5.2.7. Electric Heating Systems

#### 5.2.7.1. Electric Resistance Heater Units

**1)** Electric heaters of the baseboard type shall be controlled by remotely-mounted thermostats.

#### 5.2.7.2. Line-voltage Thermostats

**1)** Line-voltage thermostats used to control electric resistance heater units shall conform to CSA

Standard C273.4-M, "Performance Requirements for Electric Heating Line-Voltage Wall Thermostats."

## 5.2.8. Recessed Heaters

### 5.2.8.1. Insulation Behind Recessed Heaters

1) Recessed heaters that partly penetrate the *building envelope* shall be located on the warm side of the insulation and shall not increase the *overall thermal transmittance* at the projected area of the heater to more than that permitted in Section 3.3. (see Appendix E).

## 5.2.9. Air Distribution Systems Serving Spaces with Special Requirements

### 5.2.9.1. Separate Air Distribution Systems

1) Except as provided in Sentence (2), spaces with special process temperature requirements, humidity requirements, or both,

- a) shall be served by air distribution systems separate from those serving spaces requiring only comfort conditions, or
- b) shall include supplementary provisions so that the primary systems may be specifically controlled to satisfy the requirements of the zones controlled for comfort purposes only.

2) Spaces requiring only comfort heating or comfort cooling may be served by a system primarily used for process temperature and humidity control, if the total design supply air flow to these comfort zones is no more than 10% of the total design system supply air flow or does not exceed 3000 L/s.

## 5.2.10. Temperature Controls

### 5.2.10.1. System Temperature Control

1) Each heating, ventilating or air-conditioning system intended to provide comfort heating or cooling shall include at least one automatic space temperature control device.

2) Each *dwelling unit* shall be controlled by at least one thermostatic control device.

### 5.2.10.2. Temperature Control within Dwelling Units

1) *Dwelling units* shall be provided with a means to reduce the heating of each room by automatic devices, or by means of manually-operated dampers, valves or switches, as appropriate for the heating system used.

### 5.2.10.3. Characteristics of Thermostatic Controls

1) Thermostatic controls for comfort heating shall be capable of adjusting the temperature of the space they serve down to at least 13°C.

2) Thermostatic controls for comfort cooling shall be capable of adjusting the temperature of the space they serve up to at least 29°C.

### 5.2.10.4. Installation of Thermostats

1) Sensors of wall-mounted thermostats shall be installed in accordance with manufacturer's instructions and located

- a) between 1400 and 1500 mm above the floor,
- b) on interior *partitions* or walls, or on exterior walls where a minimum *effective thermal resistance* of 3.5 m<sup>2</sup>·°C/W is provided between the sensor and outdoors,
- c) away from direct exposure to sunlight and heat-producing sources, and
- d) away from draughts or dead pockets of air.

(See Appendix E.)

### 5.2.10.5. Heat Pump Controls

1) Heat pumps equipped with supplementary heaters shall incorporate controls to prevent supplementary heater operation when the heating load can be met by the heat pump alone, except during defrost cycles.

### 5.2.10.6. Space Temperature Control

1) Except as provided in Sentence (2), the supply of heating and cooling energy to a zone shall be controlled by individual thermostatic controls responding to temperature within the zone.

2) Independent perimeter systems that are designed to offset only *building envelope* heat losses or gains, or both, may be used where

- a) the perimeter system includes at least one thermostatic control for each *building* exposure having exterior walls facing only one orientation for an uninterrupted distance of 15 m or more (see Appendix E), and
- b) the perimeter system heating and cooling supply are controlled by thermostat(s) located within the zone(s) served by the system.

3) Where separate thermostatic controls are provided to control heating and cooling to a space, means shall be provided to prevent these controls from simultaneously calling for heating and cooling (see Appendix E).

## 5.2.10.7.

### 5.2.10.7. Ice- and Snow-melting Heater Controls

1) Ice- and snow-melting heaters shall be provided with either automatic controls or readily accessible manual controls that enable them to be shut down when not required.

2) Controls for ice- and snow-melting heaters shall be

- a) clearly labeled, and
- b) provided with an indicator light.

### 5.2.11. Humidification

#### 5.2.11.1. Humidification Controls

1) If a system is equipped with a means for adding or removing moisture to maintain specific humidity levels in a space, an automatic humidity control device shall be provided.

2) Humidistats required by Sentence (1) shall be capable of being set to prevent the use of energy to increase relative humidity above 30% or to decrease relative humidity below 60% for comfort purposes.

### 5.2.12. Shutoff and Setback

#### 5.2.12.1. Off-hours Controls

1) Except as provided in Sentences (3) and (4), each heating, ventilating or air-conditioning system shall be equipped with automatic controls capable of accomplishing a reduction of energy use through control temperature setback or equipment shutdown during periods of non-use of the spaces served by the system (see Appendix E).

2) Controls required by Sentence (1) shall be capable of

- a) shutdown of fan systems as well as heating and cooling equipment and auxiliaries, where appropriate, when conditioning is not required by the space,
- b) setback of the space-heating temperature setpoint,
- c) setup of the space-cooling temperature setpoint if cooling system operation is required during periods when the space is not in use,
- d) reduction or shutoff of outdoor air during heating or cooling operation when the space is not in use, such as setback or morning pickup periods, and
- e) in the case of heat pumps, temporary suppression of electrical backup or adaptive anticipation of the recovery point, in order to prevent the unit from resorting to supplementary heat at the time of recovery (see Appendix E).

3) Systems serving areas other than *dwelling units* and intended to operate continuously need not comply with Sentence (1).

4) Equipment with heating or cooling capacity of 2 kW or less may be controlled by readily accessible manual controls.

5) Controls required by Sentence (1) shall be designed so that lowering a heating thermostat setpoint will not cause energy for cooling to be expended to reach the lowered setting and raising a cooling thermostat setpoint will not cause energy for heating to be expended to reach the raised setting.

#### 5.2.12.2. Air Flow Control Areas

1) Each air distribution system serving multiple *temperature-control zones* having a combined *floor surface area of conditioned space* of more than 2500 m<sup>2</sup> shall be divided into *air flow control areas*, so that the supply of air to individual *air flow control areas* can be reduced or stopped independently of other *air flow control areas* served by the system (see Appendix E).

2) Each *air flow control area* required by Sentence (1) shall include only *temperature-control zones* intended to be operated simultaneously (see Appendix E).

3) Each *air flow control area* required by Sentence (1) shall not exceed 2500 m<sup>2</sup> in *floor surface area* and shall not span more than one *storey*.

4) Each *air flow control area* required by Sentence (1) shall be equipped with controls meeting the requirements of Article 5.2.12.1.

5) The system shall be designed such that a reduction in air delivery to any level down to 50% of design flow results in at least a proportional reduction in fan power.

6) Controls and devices shall be provided to allow stable operation of all fan systems and associated primary heating and cooling equipment for any length of time while serving a single *air flow control area*.

7) *Temperature-control zones* in which *occupancy* requirements prevent the reduction or stopping of the air supply need not be incorporated into *air flow control areas*.

#### 5.2.12.3. Seasonal Shutdown

1) Pumping systems that are used on a seasonal basis, such as heating and chilled water pumping systems, shall be provided with

- a) automatic controls, or
- b) readily accessible and clearly labeled manual controls that enable them to be shut down when not required.

#### 5.2.12.4. Multiple Boilers

1) Systems with multiple *boilers* shall incorporate means for preventing heat losses through the *boilers* when they are not in operation, such as means for preventing the flow of heat-carrying fluid through *boilers* or dampers installed in the flues.

### 5.2.13. Equipment Efficiency

#### 5.2.13.1. Unit and Packaged Equipment

1) Heating, ventilating or air-conditioning equipment and components that are included in the scope of a standard referenced in Table 5.2.13.1. shall comply with the relevant federal, provincial or territorial appliance or equipment energy-efficiency act or, in the absence of such an act or where equipment is not covered by such an act, with the relevant standard in Table 5.2.13.1.

(See Appendix E.)

(See also Article 6.3.1.1.)

**Table 5.2.13.1.**  
**Heating, Ventilation and Air-Conditioning Equipment Performance Standards**  
 Forming Part of Sentence 5.2.13.1.(1)

Component	Cooling Capacity	Standard	Rating Conditions	Minimum Performance
<b>Air-cooled Unitary Air-conditioners and Heat Pumps — Electrically operated (Except Packaged Terminal Air-conditioners and Room Air-conditioners)</b>				
Split-system	≤ 19 kW	CAN/CSA-C273.3-M (including General Instruction No. 4)		in Standard
Single package	≤ 19 kW	CAN/CSA-C656-M (including General Instruction No. 2)		
All Phases	> 19 and < 73 kW	CAN/CSA-C746		
Air-conditioners, all phases	73 - 222.7 kW (250 000 - 760 000 Btu/h)	ARI 360		EER = 8.5 <sup>(1)</sup> IPLV = 7.5 <sup>(2)</sup>
	> 222.7 kW (760 000 Btu/h)			EER = 8.2 <sup>(1)</sup> IPLV = 7.5 <sup>(2)</sup>
Heat Pumps	73 - 222.7 kW (250 000 - 760 000 Btu/h)	ARI 340	Cooling mode	EER = 8.5 <sup>(1)</sup> IPLV = 7.5 <sup>(2)</sup>
			Heating mode	47°F (8.3°C)
	17°F (-8.3°C)			COP = 2.0 <sup>(3)</sup>
	> 222.7 kW (760 000 Btu/h)		Cooling mode	EER = 8.7 <sup>(1)</sup> IPLV = 7.5 <sup>(2)</sup>
Heating mode		47°F (8.3°C)	COP = 2.9 <sup>(3)</sup>	
	17°F (-8.3°C)	COP = 2.0 <sup>(3)</sup>		

## 5.2.13.1.

Table 5.2.13.1. (Continued)

Component	Cooling Capacity	Standard	Rating Conditions	Minimum Performance
<b>Evaporatively cooled and Water/Evaporatively cooled Unitary Air-conditioners and Heat Pumps — Electrically operated (Except Packaged Terminal Air-conditioners and Room Air-conditioners)</b>				
Evaporatively cooled	≤ 19 kW (65 000 Btu/h)	ARI 210/240, CTI 201	Indoor air 80°F db/67°F wb (26.7°C db/19.4°C wb)	EER = 9.3 <sup>(1)</sup>
			Outdoor air 95°F db/75°F wb (35.0°C db/23.9°C wb)	
			80°F db/67°F wb (26.7°C db/19.4°C wb)	IPLV = 8.5 <sup>(2)</sup>
Evaporatively cooled, water/evaporatively cooled	> 19 and < 73 kW	CAN/CSA-C746		in Standard
Water/evaporatively cooled air-conditioners	≥ 73 kW	ARI 360, CTI 201		EER = 9.6 <sup>(1)</sup> IPLV = 9.0 <sup>(2)</sup>
<b>Condensing Units</b>				
Air-cooled and water/evap- oratively cooled	> 19 and < 73 kW	CAN/CSA-C746		in Standard
Air-cooled	≥ 73 kW	ARI 365		EER = 9.9 <sup>(1)</sup> IPLV = 11.0 <sup>(2)</sup>
Water/evaporatively cooled		ARI 365, CTI 201		EER = 12.9 <sup>(1)</sup> IPLV = 12.9 <sup>(2)</sup>
<b>Water-cooled Unitary Air-conditioners and Heat Pumps — Electrically operated</b>				
Ground/water-source heat pumps	< 35 kW	CAN/CSA-C446		in Standard
Internal water-loop heat pumps	< 40 kW	CAN/CSA-C655-M		
Water-cooled air- conditioners	< 19 kW	ARI 210/240, CTI 201	Indoor air 80°F db/67°F wb (26.7°C db/19.4°C wb)	EER = 9.3 <sup>(1)</sup>
			Entering water 85°F (29.4°C)	IPLV = 8.3 <sup>(2)</sup>
	Entering water 75°F (23.9°C)			
	19 - 39.5 kW		Indoor air 80°F db/67°F wb (26.7°C db/19.4°C wb)	EER = 10.5 <sup>(1)</sup>
			Entering water 85°F (29.4°C)	
<b>Direct-expansion Ground-source Heat Pumps — Electrically operated</b>				
Direct-expansion ground- source heat pumps	≤ 21 kW	CSA C748		in Standard

Table 5.2.13.1. (Continued)

Component	Cooling Capacity	Standard	Rating Conditions	Minimum Performance
<b>Packaged Terminal Air-conditioners and Heat Pumps</b>				
Packaged terminal air-conditioners and heat pumps, air-cooled, electrically operated		CSA C744 (joint standard with ARI 310/380)		in Standard
<b>Room Air-conditioners and Room Air-conditioners/Heat Pumps</b>				
Without reverse cycle	< 10.55 kW	CAN/CSA-C368.1-M		in Standard
With reverse cycle with louvered sides without louvered sides		ANSI/AHAM RAC-1		EER = 8.5 <sup>(1)</sup> EER = 8.0 <sup>(1)</sup>
<b>Packaged Water Chillers</b>				
Vapour compression, air- or water-cooled, electrically operated	< 5600 kW	CSA C743		in Standard
Absorption, single- or double-effect, indirect- or direct-fired				
<b>Boilers</b>				
Gas-fired <i>boilers</i> , <sup>(4)</sup> ≤ 117.23 kW		CGA 4.9		in Standard
Gas-fired <i>boilers</i> , > 117.23 kW		ANSI Z21.13, HI Heating Boiler Standard, ANSI/ASME PTC 4.1, UL 795	Maximum rated capacity, steady state	$E_c = 80\%$ <sup>(5)</sup>
			Minimum rated capacity, steady state	$E_c = 80\%$ <sup>(5)</sup>
Oil-fired <i>boilers</i> , ≤ 88 kW		CSA B212		in Standard
Oil-fired <i>boilers</i> (residual), > 88 kW		HI Heating Boiler Standard, ANSI/ASME PTC 4.1	Maximum rated capacity, steady state	$E_c = 83\%$ <sup>(5)</sup>
			Minimum rated capacity, steady state	$E_c = 83\%$ <sup>(5)</sup>
Oil-fired <i>boilers</i> (other), > 88 kW		ANSI/UL 726, HI Heating Boiler Standard, ANSI/ASME PTC 4.1	Maximum rated capacity, steady state	$E_c = 83\%$ <sup>(5)</sup>
			Minimum rated capacity, steady state	$E_c = 83\%$ <sup>(5)</sup>

## 5.2.13.2.

Table 5.2.13.1. (Continued)

Component	Cooling Capacity	Standard	Rating Conditions	Minimum Performance
<b>Warm-air Furnaces, Combination Warm-air Furnaces/Air-conditioning Units, Duct Furnaces and Unit Heaters</b>				
Gas-fired warm-air furnaces, <sup>(4)</sup> ≤ 117.23 kW		CAN/CGA-2.3-M		in Standard
Gas-fired warm-air furnaces, > 117.23 kW		ANSI Z21.47	Maximum rated capacity, steady state	E <sub>t</sub> = 80% <sup>(6)</sup>
			Minimum rated capacity, steady state	E <sub>t</sub> = 78% <sup>(6)</sup>
Gas-fired duct furnaces, <sup>(4)</sup> ≤ 117.23 kW		CGA 2.8-M		in Standard
Gas-fired unit heaters, <sup>(4)</sup> ≤ 117.23 kW		CAN/CGA-2.6-M		
Oil-fired warm-air furnaces, ≤ 66 kW		CSA B212		in Standard
Oil-fired warm-air furnaces, > 66 kW		CSA B140.4		
Oil-fired duct furnaces and unit heaters				

### Notes to Table 5.2.13.1.:

- (1) EER is the *energy efficiency ratio* in Btu/(h·W) (no metric equivalent)
- (2) IPLV is the *integrated part-load value* (no units)
- (3) COP is the *coefficient of performance* in W/W
- (4) Includes propane
- (5) E<sub>c</sub> is the combustion efficiency (%)
- (6) E<sub>t</sub> is the thermal efficiency (%)

### 5.2.13.2. Field-assembled Equipment and Components

**1)** When components from more than one manufacturer are used as parts of heating, ventilating or air-conditioning equipment, the system shall be designed in accordance with good engineering practice, based on component efficiency data provided by the component manufacturers, to provide the overall efficiency called for in Article 5.2.13.1.

### 5.2.13.3. Service Water Heating Equipment Used for Space Heating

**1)** *Service water* heating equipment used to provide space heating solely or in combination with *service water* heating shall comply with the relevant federal, provincial or territorial appliance or equipment energy efficiency act or, in the absence of such an act or where equipment is not covered by such an act, with the standard of Table 6.2.2.1. that is relevant to that piece of equipment.

## 5.2.14. Documentation

### 5.2.14.1. System Design and Operation

**1)** A statement of design intent and operational recommendations shall be provided to enable the systems to be operated in an efficient manner.

**2)** The statement required in Sentence (1) shall include

- a) descriptive information about each system, detailing its function, design capability, performance characteristics and distribution arrangement,
- b) schematic and control diagrams and sequence of operation; start/stop and adjustment procedures, and
- c) changeover, startup and shutdown sequences.

(See Appendix E.)

## Section 5.3. Prescriptive Compliance

### 5.3.1. Fan System Design

#### 5.3.1.1. Application

- 1) This Subsection applies to all fan systems
  - a) that are used for comfort heating, ventilating or air-conditioning, or any combination thereof,
  - b) for which the total of all fan motor nameplate ratings is 10 kW or more (see Appendix note E-5.3.1.1.(2)), and
  - c) with the exception of equipment covered by Article 5.2.13.1. for which the minimum performance includes fan energy.
- 2) For purposes of this Subsection, the power demand of a fan system is the sum of the demand of all fans required to operate at design conditions to supply air to the *conditioned space* (see Appendix E).

#### 5.3.1.2. Constant-volume Fan Systems

- 1) For systems in which the fans produce a constant air flow rate whenever the system is operating, the power demand required by the motors for the combined supply and return fan system at design conditions shall not exceed 1.6 W per L/s of supply air delivered to the *conditioned space*, as calculated using the equation given in Sentence (2) (see Appendix E).
- 2) For purposes of compliance with Sentence (1), the power demand for a fan is calculated from the following equation:

$$W = 0.001 \cdot F \cdot SP / \eta$$

where

- W = power demand (watts),  
 F = flow rate (L/s),  
 SP = design static pressure across the fan (Pa),  
 and  
 $\eta$  = combined fan-drive-motor efficiency,  
 expressed as a decimal fraction.

#### 5.3.1.3. Variable-air-volume Fan Systems

- 1) For systems in which air flow through fans varies automatically as a function of load, the power demand required by the motors for the combined supply and return fan system, as calculated using the equation in Sentence 5.3.1.2.(2), shall not exceed 2.65 W per L/s of supply air delivered to the *conditioned space* at design conditions (see Appendix E).
- 2) In variable-air-volume systems, any individual supply, relief or return fan with a power

demand greater than 7.5 kW and less than 25 kW, as calculated using the equation in Sentence 5.3.1.2.(2), shall incorporate controls and devices such that a reduction of air delivery volume to 50% of design air volume shall result in a corresponding fan power demand of no more than 55% of design wattage, based on the manufacturer's test data.

- 3) In variable-air-volume systems, any individual supply, relief or return fan with a power demand of 25 kW and larger, as calculated using the equation in Sentence 5.3.1.2.(2), shall incorporate controls and devices necessary to prevent the fan motor from demanding more than 30% of design wattage at 50% of design air volume, based on the manufacturer's test data.

### 5.3.2. Cooling with Outdoor Air

#### 5.3.2.1. Cooling with Outdoor Air Required

- 1) Except for systems serving only *dwelling units* or hotel or motel rooms, each system that incorporates mechanical cooling and has an air handling capacity of more than 1 500 L/s or a cooling capacity of more than 20 kW shall be designed to use outdoor air to reduce mechanical cooling energy by one of the means covered in this Subsection.

#### 5.3.2.2. Cooling by Direct Use of Outdoor Air (Air Economizer System)

- 1) Systems that reduce mechanical cooling energy use by direct use of outdoor air shall be capable of mixing return air with outdoor air up to 100% outdoor air to produce the temperature required to condition the space.

- 2) Systems described in Sentence (1) shall be designed to automatically revert to the minimum outdoor air flow required for acceptable indoor air quality, when either the return air temperature is less than the outdoor air temperature or the return air enthalpy is less than the outdoor air enthalpy (see Appendix E).

- 3) Except as provided in Sentence (6), systems described in Sentence (1) shall be designed to mix outdoor air and return air to a temperature as near as possible to that required to condition the space, even when mechanical cooling is being provided.

- 4) Systems described in Sentence (1) and with cooling capacities of 70 kW or more shall incorporate cooling equipment that can operate at less than full capacity, with the lowest stage providing no more than 25% of the full capacity of each system.

- 5) Systems described in Sentence (1) and with cooling capacities more than 25 kW but less

### 5.3.2.3.

than 70 kW shall incorporate cooling equipment that can operate at less than full capacity, with the lowest stage providing no more than 50% of the full capacity of each system.

**6)** Direct expansion systems may include controls to reduce the quantity of outdoor air at the lowest stage of cooling equipment output as necessary to permit proper operation of the equipment, such as to prevent coil frosting.

#### 5.3.2.3. Cooling by Indirect Use of Outdoor Air (Water Economizer System)

**1)** Systems that reduce mechanical cooling energy use by using outdoor air to chill cooling distribution fluid by direct evaporation, indirect evaporation, or both, shall be capable of cooling supply air so as to provide 100% of the cooling load when the outdoor air wet-bulb temperature is 7°C or below.

**2)** Systems that reduce mechanical cooling energy use by using outdoor air to chill cooling distribution fluid by sensible heat transfer shall be capable of cooling supply air so as to provide 100% of the cooling load when the outdoor air dry-bulb temperature is 10°C or below.

### 5.3.3. Control of Heating, Ventilating and Air-conditioning Systems

#### 5.3.3.1. Control of Temperature of Air Leaving the Supply Air Handler

**1)** Except as provided in Sentences (2) and (3), a *supply air handler* shall be designed and equipped with controls to achieve the supply air temperature without:

- a) heating previously cooled air,
- b) cooling previously heated air, or
- c) heating outdoor air, separately or mixed with return air, that is in excess of the minimum required for ventilation.

**2)** Reheating the supply air for humidity control is permitted where specified humidity levels are required to satisfy process needs or environmental requirements not related to human comfort (see Appendix E).

**3)** Reheating the supply air is permitted when such reheating does not increase the consumption of electricity or fossil fuel.

#### 5.3.3.2. Control of Space Temperature by Reheating or Recooling

**1)** Except as provided in Sentence (4), systems that control the temperature of a space by reheating previously cooled air shall be equipped with controls that will automatically adjust the

temperature of the cool air supply to the highest temperature that will satisfy the *temperature-control zone* requiring the coolest air.

**2)** Except as provided in Sentence (4), systems that control the temperature of a space by recooling previously heated air shall be equipped with controls that will automatically adjust the temperature of the warm air supply to the lowest temperature that will satisfy the *temperature-control zone* requiring the warmest air.

**3)** Except as provided in Sentence (4), systems that control the temperature of a space by mixing heated supply air and cooled supply air shall be equipped with controls that will

- a) automatically adjust the temperature of the warm supply air to the lowest temperature that will satisfy the *temperature-control zone* requiring the warmest air, and
- b) automatically adjust the temperature of the cool supply air to the highest temperature that will satisfy the *temperature-control zone* requiring the coolest air.

**4)** Systems that are designed to reduce the air supplied to each *temperature-control zone* to a minimum before reheating, recooling or mixing takes place and where this minimum supply is no greater than 2 L/s per m<sup>2</sup> of *floor surface area* of the *temperature-control zone* need not comply with Sentences (1), (2), and (3).

### 5.3.4. Heat Recovery

#### 5.3.4.1. Heat Recovery from Dehumidification in Swimming Pools

**1)** Except for pools with a water surface area of less than 10 m<sup>2</sup> and except as provided in Sentence (3), systems that exhaust air from swimming pools within *conditioned spaces* shall be capable of recovering at least 40% of sensible recoverable heat from exhaust air at design conditions (see Appendix E).

**2)** The recoverable heat from exhaust air is the sensible heat content of the total quantity of exhaust and is calculated in kilowatts as follows:

$$\text{recoverable heat} = 0.00123 \cdot Q \cdot (t_e - t_o)$$

where

- $t_e$  = temperature of exhaust air before heat recovery (°C),  
 $t_o$  = outdoor 2.5% January design temperature (°C), and

Q = rated capacity of exhaust system at normal exhaust air temperature (L/s).

- 3) Indoor swimming pools need not comply with Sentence (1) if they
- utilize a non-portable mechanical or dessicant dehumidifying system, and
  - provide 80% of the dehumidification that would result from compliance with Sentence (1).

#### 5.3.4.2. Heat Recovery from Ice-making Machines in Ice Arenas and Curling Rinks

1) Where an ice arena or a curling rink has a heating requirement, the refrigeration system shall incorporate means of recovering heat rejected by the system to the extent that the heat recovered can be used to satisfy some or all of the heating requirements (see Appendix E).

#### 5.3.4.3. Heat Recovery in Dwelling Units

1) Where a self-contained mechanical ventilation system is used to serve a single *dwelling unit* and where required in Table A-5.3.4.3. of Appendix A for the administrative region considered and for the *principal heating source* for the *building* or part of the *building* ventilated by the equipment, the principal exhaust component of such a ventilation system shall be equipped with heat-recovery capability (see Appendix E).

2) Heat-recovery ventilators used to meet the requirements of Sentence (1) shall have a sensible heat-recovery efficiency, obtained in conformity with the low temperature thermal and ventilation test method described in CAN/CSA-C439, "Standard Methods of Test for Rating the Performance of Heat-Recovery Ventilators,"

- of at least 65% at an outside air (Station 1) test temperature of 0°C, and
- of not less than that required in Table 5.3.4.3. for the 2.5% January design temperature for the *building* location, as listed in Appendix C, Climatic Information for Building Design in Canada, of the National Building Code of Canada.

(See Appendix E.)

**Table 5.3.4.3.**  
Performance of Heat-recovery Ventilators  
Forming Part of Sentence 5.3.4.3.(2)

2.5% January Design Temperature at <i>Building</i> Location	Outside Air Test Temperature at Station 1, °C	Sensible Heat-recovery Efficiency
≥ -10	0	65
< -10 and > -30	-25	55
≤ -30	-40	45

3) The tests described in Sentence (2) shall be performed at the rated air flow for continuous operation of the equipment, which meets the principal exhaust component of the ventilating system referred to in Sentence (1).

4) Where a form of heat recovery other than a heat-recovery ventilator is used to meet the requirements of Sentence (1), the alternate system shall have a heat-recovery performance equivalent to that required in Sentence (2) for heat-recovery ventilators.

## Section 5.4. Building Energy Performance Compliance

### 5.4.1. Alternate Compliance Path

#### 5.4.1.1. Non-compliance with Prescriptive Requirements

1) Where the heating, ventilating or air-conditioning system does not comply with the requirements of Section 5.3., it shall be demonstrated, using the procedures described in Part 8, Building Energy Performance Compliance, that the *building* will not use more energy than it would if the heating, ventilating or air-conditioning system did comply with Section 5.3.



---

# Part 6

## Service Water Heating Systems

### Section 6.1. General

#### 6.1.1. Scope

##### 6.1.1.1. Application

- 1) This Part applies to *service water* heating systems.
- 2) The *authority having jurisdiction* may exempt a *service water* heating system or part of a system from some or all of the requirements of this Part where it can be shown that the nature of the *occupancy* or the type of *service water* heating equipment used makes it impractical to apply these requirements (see Appendix E).

##### 6.1.1.2. Compliance

- 1) The mandatory provisions of Section 6.2. must be satisfied regardless of the compliance path chosen.
- 2) The prescriptive requirements of Section 6.3. must be satisfied unless the *building* energy performance compliance path described in Part 8 is followed.

### Section 6.2. Mandatory Provisions

#### 6.2.1. System Design

##### 6.2.1.1. Regulations

- 1) *Service water* heating systems shall be designed in accordance with the relevant provincial,

territorial or municipal building regulations or, in the absence of such regulations, or where *service water* heating systems are not covered by such regulations, with the National Plumbing Code of Canada 1995 (see Appendix E).

#### 6.2.2. Storage Vessels and Heating Equipment

##### 6.2.2.1. Equipment Efficiency

- 1) *Service water* heaters, *boilers*, storage tanks and pool heaters that are included in the scope of a standard referenced in Table 6.2.2.1. shall comply with the relevant federal, provincial or territorial appliance or equipment energy-efficiency act or, in the absence of such an act or where equipment or vessels are not covered by such an act, with the relevant standard in Table 6.2.2.1. (see Appendix E).
- 2) Except as provided by Sentence (3) and except for tanks covered by Sentence (1), hot *service water* storage tanks shall be covered with insulation having a maximum *U-value* of  $0.8 \text{ W/m}^2\cdot\text{C}$ .
- 3) Hot *service water* storage tanks located outside or in unconditioned spaces shall be covered with insulation having a maximum *U-value* of  $0.55 \text{ W/m}^2\cdot\text{C}$ .
- 4) Tank insulation located in areas where it may be subject to mechanical damage shall be protected.

## 6.2.2.1.

**Table 6.2.2.1.**  
**Service Water Heating Equipment Performance Standards**  
 Forming Part of Sentence 6.2.2.1.(1)

Component	Input	Capacity, L	V <sub>t</sub> , US gal. (L)	Input/V <sub>t</sub> , Btuh/US gal. (W/L)	Standard	Rating Conditions	Performance Requirement	
<b>Storage-type and Non-storage (Instantaneous) Service Water Heaters</b>								
Electric	≤ 12 kW	50-454			CAN/CSA-C745		in Standard	
	> 12 kW				ANSI Z21.10.3 <sup>(1)</sup>	Δt = 80°F (44.4°C)	SL ≤ 0.30 + 27/V <sub>t</sub> <sup>(2)(3)</sup>	
		> 454						
Heat pump water heaters	≤ 24 A and ≤ 250 V				CAN/CSA-C745		in Standard	
Gas-fired <sup>(4)</sup>	< 22 kW				CGA CAN1-4.1-M		in Standard	
	22-117 kW				CGA CAN1-4.3-M			
	> 117 kW				< 4000 (310)	ANSI Z21.10.3	Δt = 90°F (50°C)	E <sub>t</sub> ≥ 78% <sup>(5)</sup> SL ≤ 1.3 + 95/V <sub>t</sub> <sup>(2)(3)</sup>
				< 10 (37.8)	≥ 4000 (310)		E <sub>t</sub> ≥ 80% <sup>(5)</sup>	
			≥ 10 (37.8)	≥ 4000 (310)	Δt = 90°F (50°C)		E <sub>t</sub> ≥ 77% <sup>(5)</sup> SL ≤ 2.3 + 67/V <sub>t</sub> <sup>(2)(3)</sup>	
Oil-fired, instantaneous	≤ 61.5 kW NAECA- covered <sup>(6)</sup>				DOE test procedures, US Code of Federal Regulations, 10CFR, Part 430, Subpart B, Appendix E		EF ≥ 0.59 – 0.0019·V <sub>t</sub> <sup>(7)(8)</sup>	
		Others		< 4000 (310)	ANSI Z21.10.3 <sup>(9)</sup>	Δt = 90°F (50°C)	E <sub>t</sub> ≥ 78% <sup>(5)</sup> SL ≤ 1.3 + 95/V <sub>t</sub> <sup>(2)(3)</sup>	
	< 10 (37.8)		≥ 4000 (310)	E <sub>t</sub> ≥ 80% <sup>(5)</sup>				
	≥ 10 (37.8)		≥ 4000 (310)	Δt = 90°F (50°C)		E <sub>t</sub> ≥ 77% <sup>(5)</sup> SL ≤ 2.3 + 67/V <sub>t</sub> <sup>(2)(3)</sup>		

Table 6.2.2.1. (Continued)

Component	Input	Capacity, L	V <sub>t</sub> , US gal. (L)	Input/V <sub>t</sub> , Btuh/US gal. (W/L)	Standard	Rating Conditions	Performance Requirement
Oil-fired, storage-type	≤ 30.5 kW	≤ 190			CAN/CSA-B211-M		in Standard
	≤ 30.5 kW	> 190			DOE test procedures, US Code of Federal Regulations, 10 CFR, Part 430, Subpart B, Appendix E		EF ≥ 0.59 – 0.0019·V <sup>(7)(8)</sup>
	> 30.5 kW	> 190		< 4000 (310)	ANSI Z21.10.3 <sup>(9)</sup>	Δt = 90°F (50°C)	E <sub>t</sub> ≥ 78% <sup>(5)</sup> SL ≤ 1.3 + 95/V <sub>t</sub> <sup>(2)(3)</sup>
			< 10 (37.8)	≥ 4000 (310)		E <sub>t</sub> ≥ 80% <sup>(5)</sup>	
≥ 10 (37.8)	≥ 4000 (310)	Δt = 90°F (50°C)	E <sub>t</sub> ≥ 77% <sup>(5)</sup> SL ≤ 2.3 + 67/V <sub>t</sub> <sup>(2)(3)</sup>				
<b>Pool Heaters</b>							
Gas-fired <sup>(4)</sup>	< 117.2 kW				CGA CAN1-4.7-M		in Standard
Oil-fired					ANSI Z21.56		E <sub>t</sub> ≥ 78% <sup>(5)</sup>

**Notes to Table 6.2.2.1.:**

- (1) When testing an electric *storage-type service water heater* for *standby loss* using the test procedure of Section 2.9. of the referenced standard, the electrical supply voltage shall be maintained within ± 1% of the centre of the voltage range specified on the water heater nameplate. Also, when needed for calculations, the *thermal efficiency* (E<sub>t</sub>) shall be 98%.
- (2) V<sub>t</sub> is the storage volume in US gallons as measured according to the referenced standard.
- (3) SL is the *standby loss* (%/h).
- (4) Includes propane
- (5) E<sub>t</sub> is the thermal efficiency with 70°F (38.9°C) water temperature difference.
- (6) Consistent with the U.S. National Appliance Energy Conservation Act of 1987.
- (7) EF is the *energy factor* (%/h).
- (8) V is the storage volume in US gallons as specified by the manufacturer.
- (9) When testing an oil-fired water heater using the test procedures of Sections 2.8. and 2.9. of the referenced standard, the following modifications shall be made:
  - A vertical length of flue pipe of sufficient height to establish the minimum draft specified in the manufacturer's installation instructions shall be connected to the flue gas outlet.
  - All measurements of oil consumption shall be taken by instruments with an accuracy of ± 1% or better.
  - The burner rate shall be adjusted to achieve an hourly Btu input rate within ± 2% of the manufacturer's specified input rate, with the carbon dioxide (CO<sub>2</sub>) reading as specified by the manufacturer, with smoke number no greater than 1 and the fuel pump pressure within ± 1% of the manufacturer's specification.

**6.2.2.2. Location of Heating Equipment**

**1)** *Service water* heating equipment other than hot water storage tanks shall be installed in a *conditioned space*.

**6.2.3. Piping****6.2.3.1. Insulation**

**1)** All hot *service water* piping in circulating systems, non-circulating systems without *heat traps* and non-circulating systems with electric heating elements along the pipes to maintain temperature

shall be insulated in accordance with Table 6.2.3.1. and Sentences (2) to (4) (see Appendix E).

**2)** Where pipe insulation has a thermal conductivity of more than the range given in Table 6.2.3.1., the thickness given in the Table shall be increased by the ratio u<sub>1</sub>/u<sub>2</sub>, where u<sub>1</sub> is the higher end of the Conductivity Range for the operating temperature and u<sub>2</sub> is the measured thermal conductivity of the insulation at the Mean Rating Temperature.

**3)** Where pipe insulation has a thermal conductivity of less than the range given in

## 6.2.4.1.

Table 6.2.3.1., the thickness given in the Table shall be decreased by the ratio  $u_1/u_2$ , where  $u_1$  is the lower end of the Conductivity Range for the operating temperature and  $u_2$  is the measured thermal conductivity of the insulation at the Mean Rating Temperature.

4) The thermal conductivity of pipe insulation at the Mean Rating Temperature shall be determined in conformance with ASTM C 335,

“Standard Test Method for Steady-State Heat Transfer Properties of Horizontal Pipe Insulation.”

5) On non-circulating systems with *heat traps*, the inlet and outlet piping between the storage or heating vessel and the *heat traps*, and the first 2.4 m of outlet piping downstream of the *heat trap*, shall be insulated in accordance with Table 6.2.3.1. and Sentences 5.2.4.3.(5) to (7).

**Table 6.2.3.1.**  
**Minimum Pipe Insulation Thickness for Service Hot Water Systems**  
Forming Part of Sentences 6.2.3.1.(1), (2), (3) and (5)

Piping Location	Insulation Conductivity		Nominal Pipe Diameter, inch (mm)	Minimum Pipe Insulation Thickness, <sup>(1)</sup> mm
	Conductivity Range, W/m·°C	Mean Rating Temperature, °C		
Conditioned space	0.035-0.040	38	Runouts <sup>(1)</sup> ≤ 2 (51)	25.4
			≤ 1 (25.4)	
			1 1/4 to 2 (32 to 51)	
			2 1/2 to 4 (64 to 102)	
Non-conditioned space or outside	0.046-0.049	121	≥ 5 (127)	38.1
			Runouts <sup>(1)</sup> ≤ 2 (51)	63.5
			≤ 1 (25.4)	
			1 1/4 to 2 (32 to 51)	76.2
2 1/2 to 4 (64 to 102)	88.9			
			≥ 5 (127)	

### Notes to Table 6.2.3.1.:

(1) Applies to recirculating sections of service hot water systems and the first 2.4 m from storage tanks for non-recirculating systems.

## 6.2.4. Controls

### 6.2.4.1. Temperature Controls

1) *Service water* heating systems with storage tanks shall be equipped with automatic temperature controls capable of adjustment between the lowest and the highest acceptable temperature settings for the intended use (see Appendix E).

### 6.2.4.2. Shutdown

1) Except for systems in which the storage capacity is less than 100 L, each *service water* heating system shall be equipped with a readily accessible and clearly labeled device to allow shutting off the system, including any electric heating elements installed along the pipes to maintain temperature (see Appendix E).

### 6.2.4.3. Electric Heat Maintenance Systems

1) Electric heating elements installed along service water pipes to maintain temperature shall incorporate automatic controls that maintain hot water temperature within the range required for the intended use.

## 6.2.5. Systems with More Than One End Use Design Temperature

### 6.2.5.1. Remote or Booster Heaters

1) When less than 50% of the total design flow of a *service water* heating system has a design discharge temperature higher than 60°C, separate remote heaters or booster heaters shall be installed

for those portions of the system with a design temperature higher than 60°C (see Appendix E).

## 6.2.6. Conservation of Hot Water

### 6.2.6.1. Showers

1) Individual shower heads used for other than safety reasons shall have integral means of limiting the maximum water discharge to 9.5 L/min, when tested according to CSA Standard B125-M, "Plumbing Fittings" (see Appendix E).

2) Where multiple shower heads are served by one temperature control, each shower head shall be provided with a device, such as an occupancy sensor or self-closing valve, capable of automatically shutting off the flow of water when the shower is not in use.

### 6.2.6.2. Lavatories

1) Except in *dwelling units*, lavatory faucets shall have integral means of limiting the flow of hot water to a maximum of 8.3 L/min, when tested according to CSA Standard B125-M, "Plumbing Fittings."

2) Each lavatory in a public access wash-room of an *assembly occupancy building* shall be equipped with a device, such as an occupancy sensor or self-closing valve, capable of automatically shutting off the flow of water when the lavatory is not in use.

## 6.2.7. Swimming Pools

### 6.2.7.1. Controls

1) Pool heaters shall be equipped with a readily accessible and clearly labelled device to allow shutting off the heater without adjusting the thermostat setting and, where applicable, to allow restarting the heater without manually relighting the pilot light.

2) Except for pumps required by public health standards to operate on a 24-h basis and pumps required to operate solar or waste-heat-recovery pool-heating systems, swimming pool pumps and swimming pool heaters shall be equipped with time switches or other controls that can be set to automatically turn off the pumps and heaters when their operation is not required.

### 6.2.7.2. Pool Covers

1) Except for pools deriving more than 60% of their pool-heating energy from site-recovered energy or site solar energy, heated outdoor and indoor swimming pools and heated tubs shall be equipped with pool covers.

2) Pool covers required by Sentence (1) shall be capable of covering at least 90% of the water surface.

3) For pools and tubs heated to a temperature above 32°C, the pool cover shall have a nominal thermal transmittance of no more than 0.48 W/m<sup>2</sup>·°C.

## Section 6.3. Prescriptive Compliance

### 6.3.1. Combination Equipment

#### 6.3.1.1. Combination Service Water and Space-heating Equipment

1) Equipment shall not be used to provide both space heating and *service water* heating except when one of the following conditions is met:

- input to the combination equipment is less than 45 kW,
- input to the combination equipment is less than twice the design *service water* heating load.

(See Appendix E.)

#### 6.3.1.2. Space Heating Equipment Used for Service Water Heating

1) Space heating equipment used to provide *service water* heating solely or in combination with space heating shall comply with the relevant federal, provincial or territorial appliance or equipment energy-efficiency act or, in the absence of such an act or where equipment is not covered by such an act, with the relevant standard in Table 5.2.13.1.

## Section 6.4. Building Energy Performance Compliance

### 6.4.1. Alternate Compliance Path

#### 6.4.1.1. Non-compliance with Prescriptive Requirements

1) Where the *service water* heating system does not comply with the requirements of Section 6.3., it shall be demonstrated, using the procedures described in Part 8, Building Energy Performance Compliance, that the *building* will not use more energy than it would if the *service water* heating system did comply with Section 6.3.



# Part 7

## Electrical Power

### Section 7.1. General

#### 7.1.1. Scope

##### 7.1.1.1. Application

**1)** Except as provided in Sentence (2), this Part applies to electrical systems in *buildings* within the scope of this Code, including

- a) electrical systems serving interior spaces,
- b) electrical systems serving *building* exteriors and exterior *building* areas such as *exterior entrances*, *exterior exits*, and loading docks, and
- c) electrical systems serving grounds, parking and other exterior areas associated with the *building* site.

**2)** Required emergency systems need not comply with this Part.

##### 7.1.1.2. Compliance

**1)** The mandatory provisions of Section 7.2. must be satisfied regardless of the compliance path chosen.

### Section 7.2. Mandatory Provisions

#### 7.2.1. Electrical Distribution System

##### 7.2.1.1. Metering

**1)** Except as provided in Sentence (2), individual metering to billing accuracy, in conformance with the Canadian Regulations Relating to the Inspection of Electricity and Gas Meters and Supplies, shall be provided for

- a) *dwelling units*, and
- b) *suites* in which all electrical loads in the suite are supplied by a feeder serving only that suite.

(See Appendix E.)

**2)** *Suites* need not be metered as described in Sentence (1) where these are

- a) guest rooms or *suites* in hotels or motels,

- b) rooms or *suites* in
  - i) student residences, or
  - ii) boarding or lodging houses that do not contain cooking facilities, or
- c) *suites* in office *buildings*.

**3)** Meters required in Sentence (1) shall conform to CSA Standard CAN3-C17-M, "Alternating-Current Electricity Metering."

##### 7.2.1.2. Monitoring

(See Appendix E.)

**1)** Electrical distribution systems whose load-carrying capacity is greater than 250 kVA shall be designed to facilitate the installation of a means to monitor the energy consumption of:

- a) each tenant having a connected load of 100 kVA or more, or
- b) services, appliances and equipment serving each *storey* with a *floor surface area* greater than 1000 m<sup>2</sup> that is intended to be used as office space, including
  - i) medical offices,
  - ii) dental offices,
  - iii) radio stations, and
  - iv) support spaces serving the office space, including circulation space, service rooms, washrooms and storerooms.

(See Appendix E.)

**2)** Except as provided in Sentence (3), electrical distribution systems whose load-carrying capacity is greater than 250 kVA shall be designed to facilitate the installation of a means to monitor separately the energy consumption of electrical power feeders for:

- a) hard-wired lighting,
- b) heating, ventilating or air-conditioning systems and equipment serving multiple tenants,
- c) *service water* heating,
- d) elevators, and
- e) special equipment or systems of more than 20 kW including
  - i) computer rooms,
  - ii) kitchens,
  - iii) printing equipment, and
  - iv) baling presses.

## 7.2.2.1.

3) Ten per cent or less of the loads on a feeder described in Sentence (2) may be from another usage category.

## 7.2.2. Power Controls

### 7.2.2.1. Controls for Power Receptacles

(See Appendix E.)

1) Where exterior receptacles are provided, at least one exterior receptacle shall be controlled.

2) In addition to the requirements of Sentence (1), where receptacles are provided for indoor or outdoor parking, and where these receptacles are supplied from a panelboard that also serves a *suite*, these receptacles shall be controlled.

3) The controls referred to in Sentences (1) and (2) shall be

- switches, or
- timers, with or without manual over-ride.

4) The controls referred to in Sentences (1) and (2) shall be selected and installed in accordance with good practice, considering the operating environment of the control.

5) The controls referred to in Sentence (1) shall be located inside the *building*.

6) The controls referred to in Sentence (2) shall be accessible only to the tenants of the *suite* that is supplied by the same panelboard that supplies the receptacle.

## 7.2.3. Transformers

### 7.2.3.1. Transformer Selection

1) Selection of transformers shall comply with the relevant federal, provincial or territorial appliance or equipment energy-efficiency act or, in the absence of such an act or where transformers are not covered by such an act, with good practice.

2) Transformers shall conform to CAN/CSA-C802, "Maximum Losses for Distribution, Power, and Dry-Type Transformers," where the installed transformer falls within the scope of the standard.

## 7.2.4. Electrical Motors

### 7.2.4.1. Scope

1) Except for elevator motors and motors that are components of rated equipment, permanently wired polyphase motors serving the *building* shall comply with the relevant federal, provincial or territorial appliance or equipment energy-efficiency act or, in the absence of such an

act or where motors are not covered by such an act, with the requirements of Article 7.2.4.2.

### 7.2.4.2. Efficiency

1) Motors included in the scope of CSA Standard C390, "Energy Efficiency Test Methods for Three-Phase Induction Motors," shall have a nominal full-load motor efficiency not less than the minimum specified in Clause 4.10 of that standard.

2) Efficiency ratings of motors included in the scope of CSA Standard C390, "Energy Efficiency Test Methods for Three-Phase Induction Motors," shall be based upon a statistically valid quality control procedure conforming with that standard.

3) The nameplates of motors referred to in Sentences (1) and (2) shall list the nominal full-load motor efficiency.

## 7.2.5. Documentation

### 7.2.5.1. System Design and Operation

1) Documentation on the electrical power system shall be provided and shall include

- a single-line diagram of the *building* electrical distribution system indicating the locations of means to monitor energy consumption,
- schematic diagrams of electrical control systems for systems other than heating, ventilating and air-conditioning, and
- manufacturer's operational and maintenance information for electrical equipment.

(See Appendix E.)

---

# Part 8

## Building Energy Performance Compliance

### Section 8.1. General

#### 8.1.1. Application

##### 8.1.1.1. Scope

**1)** Except as required in Sentences (2) and (3), this Part may be used as an alternative to the prescriptive requirements of Sections 3.3., 4.3., 5.3. and 6.3. of this Code and the trade-off provisions of Section 3.4. (see Appendix note E-2.1.1.2.).

**2)** This Part shall be used only for a *building* for which sufficient information in the following categories is available to permit a performance analysis according to Article 8.2.1.3., and where this information is submitted with the permit application:

- a) the *occupancy* of the *building*,
- b) plans or specifications describing the *building envelope*, or
- c) plans or specifications for a space-conditioning system.

**3)** This Part shall not be used for a *building* in which there is no mechanical system to provide outdoor air to each *conditioned space*, or which includes systems or features that have a significant effect on energy use but cannot be analyzed using the compliance software required in Article 8.2.1.6.

**4)** The procedures of this Part shall be applied to a single *building* at a time.

##### 8.1.1.2. Staged Permit Compliance

**1)** Where the lighting installation of the *building* is not yet built and its design is not included in the current *building* permit application, the lighting shall be assumed to just meet the prescriptive requirements of this Code.

### Section 8.2. Performance Compliance

#### 8.2.1. Compliance

##### 8.2.1.1. Mandatory Provisions

**1)** In the establishment of the *building energy target*, all *building* features and systems must be accounted for in conformity with the mandatory provisions of Sections 3.2., 4.2., 5.2., 6.2. and 7.2. of this Code.

**2)** Except as provided in Sentence (3), where construction techniques are used that are more thermally efficient than those permitted in the mandatory provisions, the extra performance over the mandatory provisions shall not be used for performance compliance calculations (see Appendix note E-3.4.1.1.(6)).

**3)** In the following cases, where construction techniques are used that are more thermally efficient than those required in the mandatory provisions, performance compliance calculations may take into account the extra performance over the mandatory provisions:

- a) power allowances for entrance and exit lighting in Sentence 4.2.1.2.(1);
- b) efficiency of unit and packaged equipment listed in Table 5.2.13.1.; or
- c) efficiency of *service water* heating equipment listed in Table 6.2.2.1.

**4)** Lighting of unconditioned spaces must satisfy the requirements of Section 4.3.

**5)** *Building* assemblies in contact with the ground must satisfy the requirements of Subsection 3.2.3. for the administrative region considered and for the *principal heating source* for the *building*.

##### 8.2.1.2. Prescriptive Requirements

**1)** In the establishment of the *building energy target*, all *building* features and systems must be accounted for in conformity with the prescriptive requirements of Sections 3.3., 4.3., 5.3. and 6.3. for the administrative region considered and for the *principal heating source* for the *building* or part of the *building* enclosed by the components.

## 8.2.1.3.

### 8.2.1.3. General Requirements

1) Subject to the provisions of this Section and to the limitations of Article 8.2.1.4., the *annual adjusted energy consumption* of the *building* or part of the *building*, as determined in accordance with the rules and specifications detailed in “Performance Compliance for Buildings: Specifications for Calculation Procedures for Demonstrating Compliance to the Model National Energy Code for Buildings Using Whole Building Performance,” published by the Canadian Commission on Building and Fire Codes, shall not exceed the *building energy target* (see Appendix E).

### 8.2.1.4. Limitations

1) *Building* performance calculations described in this Part shall be subject to the limitations described in Sentences (2) to (5).

2) The *overall thermal transmittance* of *opaque components* of the *building envelope* shall not be increased to more than 167% of the maximum *overall thermal transmittance* permitted in Section 3.3.

3) The *overall thermal transmittance* of components of the *building envelope* that have radiant heating cables, pipes or membranes embedded in them shall not be increased to more than the *overall thermal transmittance* permitted by Sentence 3.3.1.1.(5).

4) *Solid masonry walls* exempted under the provisions of Sentence 3.3.1.1.(3) shall not be the subject of performance compliance calculations.

5) Doors covered in Sentences 3.3.1.3.(2) to (5) shall not be the subject of performance calculations.

### 8.2.1.5. Treatment of Additions

(See Appendix E.)

1) For the purpose of performance compliance calculations, the compliance of *additions* shall be based upon either

- a) the *addition* being considered by itself, or
- b) the *addition* being considered together with the existing *building*, in which case both the *building energy target* and the *annual adjusted energy consumption* of the *building* shall be determined using the existing thermal characteristics of existing components of the *building envelope*.

2) When evaluating an *addition* together with the existing *building* for compliance with this Part, the existing characteristics of a component that is already built shall be its actual characteristics as determined, to the extent possible, in the same way as required in Part 2 of this Code for new components.

### 8.2.1.6. Compliance Software

1) Evaluation of compliance with Article 8.2.1.3. shall be done through computer software that conforms to specifications detailed in “Performance Compliance for Buildings, Specifications for Calculation Procedures for Demonstrating Compliance to the Model National Energy Code for Buildings Using Whole Building Performance,” published by the Canadian Commission on Building and Fire Codes.

### 8.2.1.7. Energy Source Adjustment Factor

1) When calculating the *building energy target* and the *annual adjusted energy consumption* of a *building* under this Part, the consumption of energy from each source shall be adjusted by multiplying it by the *energy source adjustment factor* shown in Table D-1 of Appendix D for the administrative region considered.

### 8.2.1.8. Energy Excluded

1) Loads of redundant or backup equipment may be excluded, on the condition that controls are provided to allow such equipment to operate only when the primary equipment is not operating.

---

# Appendix A

## Regional Requirements

**General** The legal definition and/or geographical boundaries of the regions listed in this Appendix shall be as described in the adopting legislation of the authority having jurisdiction.

**A-3.3.1.1.(1) Roof and Floor Types in Appendix A Tables.** The tables in Appendix A differentiate between various types of construction for roofs and floors:

- **Type I Roofs:** roofs where the space available for the inclusion of insulation is ample, such as for attic-type roofs, hopper roofs and pitched or scissors trusses; “attic” here implies that the roof and ceiling are framed separately;
- **Type II Roofs and Type I Floors:** roofs or floors where the space available for the inclusion of insulation is limited because of the large incremental cost of a greater depth of the structural members, such as for sawn-lumber joists and wood I-joists, sheet-steel and open-web joists, or parallel-chord trusses;
- **Type III Roofs and Type II Floors:** generally all other types of roofs or floors, such as those where rigid insulation is used and where the insulation is not contained within the depth of the structural members but is installed above or below the deck; for example, concrete decks with rigid insulation.

**A-3.3.1.2.(1) Windows in Appendix A Tables:**

### Solar Heat Gain Coefficient

Appendix A does not contain requirements for the solar heat gain coefficient of fenestration. An attempt to account for the solar heat gain coefficient resulted, in nearly all cases, in a penalty for tinted glazing; analysis showed that a lower solar heat gain coefficient reduced cooling, but increased heating resulted in an increase in total energy consumption. Since it is generally accepted that a lower solar heat gain coefficient has benefits such as system size reductions and comfort improvements, such a penalty for tinted glazing was not considered appropriate. Therefore, this Code treats the solar heat gain coefficient as being completely neutral; a design is neither rewarded nor penalized for tinted glazing.

### Fixed and Operable Windows Having Different Requirements

It may appear illogical that the U-value requirement for operable windows would be a less stringent requirement than that for fixed windows, for the same zone and fuel. A partial explanation is that the two types of windows are evaluated under the CSA standard using different arbitrary sizes: therefore, the two types do not have the same frame-to-glass ratio. Another reason is that for the same technology (type of glass, number of layers of glass, edge-filler type, etc.), an operable window will have poorer performance than its fixed counterpart because the extra sashes and hardware needed to make the window operable generally have a negative impact on overall energy performance. Therefore, different requirements for fixed and operable windows don't necessarily involve different technologies. In fact, the window requirements for houses were chosen to ensure that the same technology could be used for both fixed and operable windows in a given house. However, because of the complexity of window selection in other types of buildings, this kind of rationalization was not necessary for the Model National Energy Code of Canada for Buildings and both cases were optimized separately.



# Newfoundland

## Region A – Island, except Northern Peninsula

**Table A-3.2.3.1.**  
**Mandatory Provisions – Building Assemblies in Contact with the Ground**  
 Forming Part of Sentences 3.2.3.1.(1), 3.2.3.2.(1) and 3.2.3.3.(1) and (2)

Assembly Description	Principal Heating Source		
	Electricity, Other	Oil, Propane, Heat Pump	–
	Minimum Effective Thermal Resistance (RSI-value), m <sup>2</sup> ·°C/W		
<b>Walls and Roofs:</b>			
Type I - finished	3.10	2.00	–
Type II - otherwise unfinished	3.10	2.00	–
<b>Floors-on-ground:</b>			
Type I - with imbedded heating cables, ducts or pipes (e.g., radiant heating slabs)	2.80 @ full floor area	1.08 @ full floor area	–
Type II - other floors-on-ground less than 0.6 m below grade (e.g., concrete slab with rigid insulation)	1.50 @ perimeter	1.08 @ perimeter	–

**Table A-3.3.1.1.(1)**  
**Prescriptive Requirements – Above-ground Building Assemblies**  
 Forming Part of Sentence 3.3.1.1.(1)

Assembly Description	Principal Heating Source		
	Electricity, Other	Oil, Propane, Heat Pump	–
	Maximum Overall Thermal Transmittance (U-value), W/m <sup>2</sup> ·°C		
<b>Roofs (See Appendix Note A-3.3.1.1.(1)):</b>			
Type I - attic-type roofs	0.100	0.180	–
Type II - parallel-chord trusses and joist-type roofs	0.200	0.230	–
Type III - all other roofs (e.g., concrete decks with rigid insulation)	0.250	0.410	–
<b>Walls</b>	0.270	0.480	–
<b>Floors:</b>			
Type I - parallel-chord trusses and joist-type floors	0.200	0.220	–
Type II - all other floors (e.g., concrete slabs with rigid insulation)	0.250	0.410	–

**Table A-3.3.1.1.(3)**  
**Prescriptive Requirements – Solid Masonry Walls**  
 Forming Part of Sentence 3.3.1.1.(3)

Wall Description	Principal Heating Source		
	Electricity, Other	Oil, Propane, Heat Pump	–
Solid masonry walls with no interior or exterior finish that incorporates insulation or creates a space that could accommodate insulation	not exempted	exempted	–

**Table A-3.3.1.2.**  
**Prescriptive Requirements – Fenestration<sup>(1)</sup>**  
 Forming Part of Sentence 3.3.1.2.(1)

Assembly Description	Fenestration-to-Wall Ratio	Principal Heating Source		
		Electricity, Other	Oil, Propane, Heat Pump	–
		Maximum Overall Thermal Transmittance (U-value), W/m <sup>2</sup> .°C		
Fixed Glazing without Sash	up to 0.4	1.80	3.20	–
	> 0.4 to 0.5	1.70	2.80	–
	> 0.5 to 0.6	1.60	2.50	–
	> 0.6 to 0.7	1.60	2.30	–
	> 0.7 to 0.8	1.50	2.10	–
	> 0.8 to 0.9	1.40	2.00	–
	> 0.9	1.40	1.90	–
Operable or Fixed Glazing with Sash	up to 0.4	1.90	3.40	–
	> 0.4 to 0.5	1.80	3.00	–
	> 0.5 to 0.6	1.70	2.60	–
	> 0.6 to 0.7	1.60	2.40	–
	> 0.7 to 0.8	1.50	2.20	–
	> 0.8 to 0.9	1.50	2.10	–
	> 0.9	1.40	1.90	–

**Notes to Table A-3.3.1.2.:**

(1) See Appendix Note A-3.3.1.2.(1)

**Table A-5.3.4.3.**  
**Prescriptive Requirements – Heat Recovery**  
 Forming Part of Sentence 5.3.4.3.(1)

Description	Principal Heating Source		
	Electricity, Other	Oil, Propane, Heat Pump	–
Heat recovery on principal exhaust component of the mechanical ventilation system in dwelling units	required	required	–

**Region B – Northern Peninsula and Labrador Coast**

**Table A-3.2.3.1.**  
**Mandatory Provisions – Building Assemblies in Contact with the Ground**  
 Forming Part of Sentences 3.2.3.1.(1), 3.2.3.2.(1) and 3.2.3.3.(1) and (2)

Assembly Description	Principal Heating Source		
	Electricity, Other	Oil, Propane, Heat Pump	-
	Minimum Effective Thermal Resistance (RSI-value), m <sup>2</sup> ·°C/W		
<b>Walls and Roofs:</b>			
Type I - finished	3.10	2.40	-
Type II - otherwise unfinished	3.10	2.40	-
<b>Floors-on-ground:</b>			
Type I - with imbedded heating cables, ducts or pipes (e.g., radiant heating slabs)	2.80 @ full floor area	1.08 @ full floor area	-
Type II - other floors-on-ground less than 0.6 m below grade (e.g., concrete slab with rigid insulation)	2.80 @ full floor area	1.08 @ perimeter	-

**Table A-3.3.1.1.(1)**  
**Prescriptive Requirements – Above-ground Building Assemblies**  
 Forming Part of Sentence 3.3.1.1.(1)

Assembly Description	Principal Heating Source		
	Electricity, Other	Oil, Propane, Heat Pump	-
	Maximum Overall Thermal Transmittance (U-value), W/m <sup>2</sup> ·°C		
<b>Roofs (See Appendix Note A-3.3.1.1.(1)):</b>			
Type I - attic-type roofs	0.100	0.140	-
Type II - parallel-chord trusses and joist-type roofs	0.130	0.230	-
Type III - all other roofs (e.g., concrete decks with rigid insulation)	0.180	0.290	-
<b>Walls</b>	0.270	0.370	-
<b>Floors:</b>			
Type I - parallel-chord trusses and joist-type floors	0.130	0.220	-
Type II - all other floors (e.g., concrete slabs with rigid insulation)	0.180	0.290	-

**Table A-3.3.1.1.(3)**  
**Prescriptive Requirements – Solid Masonry Walls**  
 Forming Part of Sentence 3.3.1.1.(3)

Wall Description	Principal Heating Source		
	Electricity, Other	Oil, Propane, Heat Pump	-
Solid masonry walls with no interior or exterior finish that incorporates insulation or creates a space that could accommodate insulation	not exempted	not exempted	-

**Table A-3.3.1.2.**  
**Prescriptive Requirements – Fenestration<sup>(1)</sup>**  
 Forming Part of Sentence 3.3.1.2.(1)

Assembly Description	Fenestration-to-Wall Ratio	Principal Heating Source		
		Electricity, Other	Oil, Propane, Heat Pump	-
		Maximum Overall Thermal Transmittance (U-value), W/m <sup>2</sup> .°C		
Fixed Glazing without Sash	up to 0.4	1.20	2.10	-
	> 0.4 to 0.5	1.20	1.80	-
	> 0.5 to 0.6	1.20	1.60	-
	> 0.6 to 0.7	1.10	1.50	-
	> 0.7 to 0.8	1.10	1.40	-
	> 0.8 to 0.9	1.10	1.30	-
	> 0.9	1.10	1.20	-
Operable or Fixed Glazing with Sash	up to 0.4	1.60	2.80	-
	> 0.4 to 0.5	1.50	2.40	-
	> 0.5 to 0.6	1.40	2.10	-
	> 0.6 to 0.7	1.40	1.90	-
	> 0.7 to 0.8	1.30	1.80	-
	> 0.8 to 0.9	1.30	1.70	-
	> 0.9	1.20	1.60	-

**Notes to Table A-3.3.1.2.:**

(1) See Appendix Note A-3.3.1.2.(1)

**Table A-5.3.4.3.**  
**Prescriptive Requirements – Heat Recovery**  
 Forming Part of Sentence 5.3.4.3.(1)

Description	Principal Heating Source		
	Electricity, Other	Oil, Propane, Heat Pump	-
Heat recovery on principal exhaust component of the mechanical ventilation system in dwelling units	required	required	-

**Region C – Goose Bay/Happy Valley**

**Table A-3.2.3.1.**  
**Mandatory Provisions – Building Assemblies in Contact with the Ground**  
 Forming Part of Sentences 3.2.3.1.(1), 3.2.3.2.(1) and 3.2.3.3.(1) and (2)

Assembly Description	Principal Heating Source		
	Electricity, Other	Oil, Propane, Heat Pump	-
	Minimum Effective Thermal Resistance (RSI-value), m <sup>2</sup> ·°C/W		
<b>Walls and Roofs:</b>			
Type I - finished	2.40	2.40	-
Type II - otherwise unfinished	2.40	2.40	-
<b>Floors-on-ground:</b>			
Type I - with imbedded heating cables, ducts or pipes (e.g., radiant heating slabs)	1.08 @ full floor area	1.08 @ full floor area	-
Type II - other floors-on-ground less than 0.6 m below grade (e.g., concrete slab with rigid insulation)	1.08 @ perimeter	1.08 @ perimeter	-

**Table A-3.3.1.1.(1)**  
**Prescriptive Requirements – Above-ground Building Assemblies**  
 Forming Part of Sentence 3.3.1.1.(1)

Assembly Description	Principal Heating Source		
	Electricity, Other	Oil, Propane, Heat Pump	-
	Maximum Overall Thermal Transmittance (U-value), W/m <sup>2</sup> ·°C		
<b>Roofs (See Appendix Note A-3.3.1.1.(1)):</b>			
Type I - attic-type roofs	0.140	0.140	-
Type II - parallel-chord trusses and joist-type roofs	0.230	0.230	-
Type III - all other roofs (e.g., concrete decks with rigid insulation)	0.290	0.290	-
<b>Walls</b>	0.330	0.370	-
<b>Floors:</b>			
Type I - parallel-chord trusses and joist-type floors	0.220	0.220	-
Type II - all other floors (e.g., concrete slabs with rigid insulation)	0.290	0.290	-

**Table A-3.3.1.1.(3)**  
**Prescriptive Requirements – Solid Masonry Walls**  
 Forming Part of Sentence 3.3.1.1.(3)

Wall Description	Principal Heating Source		
	Electricity, Other	Oil, Propane, Heat Pump	-
Solid masonry walls with no interior or exterior finish that incorporates insulation or creates a space that could accommodate insulation	not exempted	not exempted	-

**Table A-3.3.1.2.**  
**Prescriptive Requirements – Fenestration<sup>(1)</sup>**  
 Forming Part of Sentence 3.3.1.2.(1)

Assembly Description	Fenestration-to-Wall Ratio	Principal Heating Source		
		Electricity, Other	Oil, Propane, Heat Pump	-
		Maximum Overall Thermal Transmittance (U-value), W/m <sup>2</sup> .°C		
Fixed Glazing without Sash	up to 0.4	2.10	2.10	-
	> 0.4 to 0.5	1.90	1.90	-
	> 0.5 to 0.6	1.80	1.80	-
	> 0.6 to 0.7	1.70	1.70	-
	> 0.7 to 0.8	1.60	1.60	-
	> 0.8 to 0.9	1.60	1.50	-
	> 0.9	1.50	1.50	-
Operable or Fixed Glazing with Sash	up to 0.4	2.80	2.80	-
	> 0.4 to 0.5	2.50	2.50	-
	> 0.5 to 0.6	2.30	2.30	-
	> 0.6 to 0.7	2.10	2.10	-
	> 0.7 to 0.8	2.00	2.00	-
	> 0.8 to 0.9	1.90	1.90	-
	> 0.9	1.80	1.80	-

**Notes to Table A-3.3.1.2.:**

(1) See Appendix Note A-3.3.1.2.(1)

**Table A-5.3.4.3.**  
**Prescriptive Requirements – Heat Recovery**  
 Forming Part of Sentence 5.3.4.3.(1)

Description	Principal Heating Source		
	Electricity, Other	Oil, Propane, Heat Pump	-
Heat recovery on principal exhaust component of the mechanical ventilation system in dwelling units	required	required	-

**Region D – Western Labrador**

**Table A-3.2.3.1.**  
**Mandatory Provisions – Building Assemblies in Contact with the Ground**  
 Forming Part of Sentences 3.2.3.1.(1), 3.2.3.2.(1) and 3.2.3.3.(1) and (2)

Assembly Description	Principal Heating Source		
	Electricity, Other	Oil, Propane, Heat Pump	-
	Minimum Effective Thermal Resistance (RSI-value), m <sup>2</sup> ·°C/W		
<b>Walls and Roofs:</b>			
Type I - finished	2.40	2.40	-
Type II - otherwise unfinished	2.40	2.40	-
<b>Floors-on-ground:</b>			
Type I - with imbedded heating cables, ducts or pipes (e.g., radiant heating slabs)	1.08 @ full floor area	1.08 @ full floor area	-
Type II - other floors-on-ground less than 0.6 m below grade (e.g., concrete slab with rigid insulation)	1.08 @ perimeter	1.08 @ perimeter	-

**Table A-3.3.1.1.(1)**  
**Prescriptive Requirements – Above-ground Building Assemblies**  
 Forming Part of Sentence 3.3.1.1.(1)

Assembly Description	Principal Heating Source		
	Electricity, Other	Oil, Propane, Heat Pump	-
	Maximum Overall Thermal Transmittance (U-value), W/m <sup>2</sup> ·°C		
<b>Roofs (See Appendix Note A-3.3.1.1.(1)):</b>			
Type I - attic-type roofs	0.140	0.140	-
Type II - parallel-chord trusses and joist-type roofs	0.230	0.230	-
Type III - all other roofs (e.g., concrete decks with rigid insulation)	0.290	0.290	-
<b>Walls</b>	0.370	0.330	-
<b>Floors:</b>			
Type I - parallel-chord trusses and joist-type floors	0.220	0.220	-
Type II - all other floors (e.g., concrete slabs with rigid insulation)	0.290	0.290	-

**Table A-3.3.1.1.(3)**  
**Prescriptive Requirements – Solid Masonry Walls**  
 Forming Part of Sentence 3.3.1.1.(3)

Wall Description	Principal Heating Source		
	Electricity, Other	Oil, Propane, Heat Pump	-
Solid masonry walls with no interior or exterior finish that incorporates insulation or creates a space that could accommodate insulation	not exempted	not exempted	-

**Table A-3.3.1.2.**  
**Prescriptive Requirements – Fenestration<sup>(1)</sup>**  
 Forming Part of Sentence 3.3.1.2.(1)

Assembly Description	Fenestration-to-Wall Ratio	Principal Heating Source		
		Electricity, Other	Oil, Propane, Heat Pump	-
		Maximum Overall Thermal Transmittance (U-value), W/m <sup>2</sup> .°C		
Fixed Glazing without Sash	up to 0.4	2.10	2.10	-
	> 0.4 to 0.5	1.90	1.90	-
	> 0.5 to 0.6	1.80	1.80	-
	> 0.6 to 0.7	1.70	1.70	-
	> 0.7 to 0.8	1.60	1.60	-
	> 0.8 to 0.9	1.60	1.60	-
	> 0.9	1.50	1.50	-
Operable or Fixed Glazing with Sash	up to 0.4	2.80	2.80	-
	> 0.4 to 0.5	2.50	2.50	-
	> 0.5 to 0.6	2.30	2.30	-
	> 0.6 to 0.7	2.10	2.10	-
	> 0.7 to 0.8	2.00	2.00	-
	> 0.8 to 0.9	1.90	1.90	-
	> 0.9	1.80	1.80	-

**Notes to Table A-3.3.1.2.:**

(1) See Appendix Note A-3.3.1.2.(1)

**Table A-5.3.4.3.**  
**Prescriptive Requirements – Heat Recovery**  
 Forming Part of Sentence 5.3.4.3.(1)

Description	Principal Heating Source		
	Electricity, Other	Oil, Propane, Heat Pump	-
Heat recovery on principal exhaust component of the mechanical ventilation system in dwelling units	required	required	-

# Prince Edward Island

## Region A – Prince Edward Island

**Table A-3.2.3.1.**  
**Mandatory Provisions – Building Assemblies in Contact with the Ground**  
 Forming Part of Sentences 3.2.3.1.(1), 3.2.3.2.(1) and 3.2.3.3.(1) and (2)

Assembly Description	Principal Heating Source		
	Electricity, Other	Propane	Oil, Heat Pump
	Minimum Effective Thermal Resistance (RSI-value), m <sup>2</sup> ·°C/W		
<b>Walls and Roofs:</b>			
Type I - finished	3.10	3.10	2.40
Type II - otherwise unfinished	3.10	3.10	2.40
<b>Floors-on-ground:</b>			
Type I - with imbedded heating cables, ducts or pipes (e.g., radiant heating slabs)	1.90 @ full floor area	1.50 @ full floor area	1.08 @ full floor area
Type II - other floors-on-ground less than 0.6 m below grade (e.g., concrete slab with rigid insulation)	1.50 @ perimeter	1.08 @ perimeter	1.08 @ perimeter

**Table A-3.3.1.1.(1)**  
**Prescriptive Requirements – Above-ground Building Assemblies**  
 Forming Part of Sentence 3.3.1.1.(1)

Assembly Description	Principal Heating Source		
	Electricity, Other	Propane	Oil, Heat Pump
	Maximum Overall Thermal Transmittance (U-value), W/m <sup>2</sup> ·°C		
<b>Roofs (See Appendix Note A-3.3.1.1.(1)):</b>			
Type I - attic-type roofs	0.100	0.120	0.140
Type II - parallel-chord trusses and joist-type roofs	0.200	0.200	0.230
Type III - all other roofs (e.g., concrete decks with rigid insulation)	0.250	0.270	0.290
<b>Walls</b>	0.270	0.270	0.370
<b>Floors:</b>			
Type I - parallel-chord trusses and joist-type floors	0.200	0.200	0.220
Type II - all other floors (e.g., concrete slabs with rigid insulation)	0.250	0.270	0.290

**Table A-3.3.1.1.(3)**  
**Prescriptive Requirements – Solid Masonry Walls**  
 Forming Part of Sentence 3.3.1.1.(3)

Wall Description	Principal Heating Source		
	Electricity, Other	Propane	Oil, Heat Pump
Solid masonry walls with no interior or exterior finish that incorporates insulation or creates a space that could accommodate insulation	not exempted	not exempted	not exempted

**Table A-3.3.1.2.**  
**Prescriptive Requirements – Fenestration<sup>(1)</sup>**  
 Forming Part of Sentence 3.3.1.2.(1)

Assembly Description	Fenestration-to-Wall Ratio	Principal Heating Source		
		Electricity, Other	Propane	Oil, Heat Pump
		Maximum Overall Thermal Transmittance (U-value), W/m <sup>2</sup> ·°C		
Fixed Glazing without Sash	up to 0.4	1.80	2.10	2.10
	> 0.4 to 0.5	1.70	1.90	1.90
	> 0.5 to 0.6	1.60	1.70	1.70
	> 0.6 to 0.7	1.50	1.60	1.60
	> 0.7 to 0.8	1.50	1.50	1.50
	> 0.8 to 0.9	1.40	1.50	1.40
	> 0.9	1.30	1.40	1.30
Operable or Fixed Glazing with Sash	up to 0.4	1.90	2.80	2.80
	> 0.4 to 0.5	1.80	2.50	2.40
	> 0.5 to 0.6	1.70	2.20	2.20
	> 0.6 to 0.7	1.60	2.10	2.00
	> 0.7 to 0.8	1.50	2.00	1.90
	> 0.8 to 0.9	1.40	1.80	1.80
	> 0.9	1.40	1.80	1.70

**Notes to Table A-3.3.1.2.:**

(1) See Appendix Note A-3.3.1.2.(1)

**Table A-5.3.4.3.**  
**Prescriptive Requirements – Heat Recovery**  
 Forming Part of Sentence 5.3.4.3.(1)

Description	Principal Heating Source		
	Electricity, Other	Propane	Oil, Heat Pump
Heat recovery on principal exhaust component of the mechanical ventilation system in dwelling units	required	required	-

# Nova Scotia

## Region A – Nova Scotia

**Table A-3.2.3.1.**  
**Mandatory Provisions – Building Assemblies in Contact with the Ground**  
 Forming Part of Sentences 3.2.3.1.(1), 3.2.3.2.(1) and 3.2.3.3.(1) and (2)

Assembly Description	Principal Heating Source		
	Electricity, Other	Propane, Heat Pump	Oil
	Minimum Effective Thermal Resistance (RSI-value), m <sup>2</sup> ·°C/W		
<b>Walls and Roofs:</b>			
Type I - finished	3.10	2.70	1.70
Type II - otherwise unfinished	3.10	2.70	1.70
<b>Floors-on-ground:</b>			
Type I - with imbedded heating cables, ducts or pipes (e.g., radiant heating slabs)	1.50 @ full floor area	1.08 @ full floor area	1.08 @ full floor area
Type II - other floors-on-ground less than 0.6 m below grade (e.g., concrete slab with rigid insulation)	1.08 @ perimeter	1.08 @ perimeter	1.08 @ perimeter

**Table A-3.3.1.1.(1)**  
**Prescriptive Requirements – Above-ground Building Assemblies**  
 Forming Part of Sentence 3.3.1.1.(1)

Assembly Description	Principal Heating Source		
	Electricity, Other	Propane, Heat Pump	Oil
	Maximum Overall Thermal Transmittance (U-value), W/m <sup>2</sup> ·°C		
<b>Roofs (See Appendix Note A-3.3.1.1.(1)):</b>			
Type I - attic-type roofs	0.120	0.140	0.200
Type II - parallel-chord trusses and joist-type roofs	0.200	0.230	0.230
Type III - all other roofs (e.g., concrete decks with rigid insulation)	0.270	0.290	0.410
<b>Walls</b>	0.270	0.370	0.480
<b>Floors:</b>			
Type I - parallel-chord trusses and joist-type floors	0.200	0.220	0.220
Type II - all other floors (e.g., concrete slabs with rigid insulation)	0.270	0.290	0.410

**Table A-3.3.1.1.(3)**  
**Prescriptive Requirements – Solid Masonry Walls**  
 Forming Part of Sentence 3.3.1.1.(3)

Wall Description	Principal Heating Source		
	Electricity, Other	Propane, Heat Pump	Oil
Solid masonry walls with no interior or exterior finish that incorporates insulation or creates a space that could accommodate insulation	not exempted	not exempted	exempted

**Table A-3.3.1.2.**  
**Prescriptive Requirements – Fenestration<sup>(1)</sup>**  
 Forming Part of Sentence 3.3.1.2.(1)

Assembly Description	Fenestration-to-Wall Ratio	Principal Heating Source		
		Electricity, Other	Propane, Heat Pump	Oil
		Maximum Overall Thermal Transmittance (U-value), W/m <sup>2</sup> .°C		
Fixed Glazing without Sash	up to 0.4	1.80	2.10	3.20
	> 0.4 to 0.5	1.70	1.90	2.80
	> 0.5 to 0.6	1.60	1.80	2.50
	> 0.6 to 0.7	1.60	1.70	2.30
	> 0.7 to 0.8	1.50	1.60	2.10
	> 0.8 to 0.9	1.50	1.50	2.00
	> 0.9	1.40	1.50	1.90
Operable or Fixed Glazing with Sash	up to 0.4	2.80	2.80	3.40
	> 0.4 to 0.5	2.50	2.50	3.00
	> 0.5 to 0.6	2.30	2.30	2.60
	> 0.6 to 0.7	2.20	2.10	2.40
	> 0.7 to 0.8	2.00	2.00	2.20
	> 0.8 to 0.9	1.90	1.90	2.10
	> 0.9	1.90	1.80	1.90

**Notes to Table A-3.3.1.2.:**

(1) See Appendix Note A-3.3.1.2.(1)

**Table A-5.3.4.3.**  
**Prescriptive Requirements – Heat Recovery**  
 Forming Part of Sentence 5.3.4.3.(1)

Description	Principal Heating Source		
	Electricity, Other	Propane, Heat Pump	Oil
Heat recovery on principal exhaust component of the mechanical ventilation system in dwelling units	required	required	-

# New Brunswick

## Region A – New Brunswick

**Table A-3.2.3.1.**  
**Mandatory Provisions – Building Assemblies in Contact with the Ground**  
 Forming Part of Sentences 3.2.3.1.(1), 3.2.3.2.(1) and 3.2.3.3.(1) and (2)

Assembly Description	Principal Heating Source		
	Electricity, Other	Propane	Oil, Heat Pump
	Minimum Effective Thermal Resistance (RSI-value), m <sup>2</sup> ·°C/W		
<b>Walls and Roofs:</b>			
Type I - finished	2.40	3.10	1.70
Type II - otherwise unfinished	2.40	3.10	1.70
<b>Floors-on-ground:</b>			
Type I - with imbedded heating cables, ducts or pipes (e.g., radiant heating slabs)	1.08 @ full floor area	1.50 @ full floor area	1.08 @ full floor area
Type II - other floors-on-ground less than 0.6 m below grade (e.g., concrete slab with rigid insulation)	1.08 @ perimeter	1.08 @ perimeter	1.08 @ perimeter

**Table A-3.3.1.1.(1)**  
**Prescriptive Requirements – Above-ground Building Assemblies**  
 Forming Part of Sentence 3.3.1.1.(1)

Assembly Description	Principal Heating Source		
	Electricity, Other	Propane	Oil, Heat Pump
	Maximum Overall Thermal Transmittance (U-value), W/m <sup>2</sup> ·°C		
<b>Roofs (See Appendix Note A-3.3.1.1.(1)):</b>			
Type I - attic-type roofs	0.140	0.120	0.180
Type II - parallel-chord trusses and joist-type roofs	0.230	0.200	0.230
Type III - all other roofs (e.g., concrete decks with rigid insulation)	0.290	0.270	0.410
<b>Walls</b>	0.330	0.270	0.480
<b>Floors:</b>			
Type I - parallel-chord trusses and joist-type floors	0.220	0.200	0.220
Type II - all other floors (e.g., concrete slabs with rigid insulation)	0.290	0.270	0.410

**Table A-3.3.1.1.(3)**  
**Prescriptive Requirements – Solid Masonry Walls**  
 Forming Part of Sentence 3.3.1.1.(3)

Wall Description	Principal Heating Source		
	Electricity, Other	Propane	Oil, Heat Pump
Solid masonry walls with no interior or exterior finish that incorporates insulation or creates a space that could accommodate insulation	not exempted	not exempted	exempted

**Table A-3.3.1.2.**  
**Prescriptive Requirements – Fenestration<sup>(1)</sup>**  
 Forming Part of Sentence 3.3.1.2.(1)

Assembly Description	Fenestration-to-Wall Ratio	Principal Heating Source		
		Electricity, Other	Propane	Oil, Heat Pump
		Maximum Overall Thermal Transmittance (U-value), W/m <sup>2</sup> ·°C		
Fixed Glazing without Sash	up to 0.4	2.10	1.80	3.20
	> 0.4 to 0.5	1.90	1.70	2.80
	> 0.5 to 0.6	1.80	1.60	2.50
	> 0.6 to 0.7	1.70	1.60	2.30
	> 0.7 to 0.8	1.60	1.50	2.10
	> 0.8 to 0.9	1.50	1.40	2.00
	> 0.9	1.50	1.40	1.90
Operable or Fixed Glazing with Sash	up to 0.4	2.80	2.80	3.40
	> 0.4 to 0.5	2.50	2.50	3.00
	> 0.5 to 0.6	2.30	2.30	2.70
	> 0.6 to 0.7	2.10	2.10	2.40
	> 0.7 to 0.8	2.00	2.00	2.20
	> 0.8 to 0.9	1.90	1.90	2.10
	> 0.9	1.80	1.80	2.00

**Notes to Table A-3.3.1.2.:**

(1) See Appendix Note A-3.3.1.2.(1)

**Table A-5.3.4.3.**  
**Prescriptive Requirements – Heat Recovery**  
 Forming Part of Sentence 5.3.4.3.(1)

Description	Principal Heating Source		
	Electricity, Other	Propane	Oil, Heat Pump
Heat recovery on principal exhaust component of the mechanical ventilation system in dwelling units	required	required	-

# Quebec

## Region A – (existing Zone A)

**Table A-3.2.3.1.**  
**Mandatory Provisions – Building Assemblies in Contact with the Ground**  
 Forming Part of Sentences 3.2.3.1.(1), 3.2.3.2.(1) and 3.2.3.3.(1) and (2)

Assembly Description	Principal Heating Source		
	All Sources	-	-
	Minimum Effective Thermal Resistance (RSI-value), m <sup>2</sup> ·°C/W		
<b>Walls and Roofs:</b>			
Type I - finished	2.40	-	-
Type II - otherwise unfinished	2.40	-	-
<b>Floors-on-ground:</b>			
Type I - with imbedded heating cables, ducts or pipes (e.g., radiant heating slabs)	1.08 @ full floor area	-	-
Type II - other floors-on-ground less than 0.6 m below grade (e.g., concrete slab with rigid insulation)	1.08 @ perimeter	-	-

**Table A-3.3.1.1.(1)**  
**Prescriptive Requirements – Above-ground Building Assemblies**  
 Forming Part of Sentence 3.3.1.1.(1)

Assembly Description	Principal Heating Source		
	All Sources	-	-
	Maximum Overall Thermal Transmittance (U-value), W/m <sup>2</sup> ·°C		
<b>Roofs (See Appendix Note A-3.3.1.1.(1)):</b>			
Type I - attic-type roofs	0.140	-	-
Type II - parallel-chord trusses and joist-type roofs	0.230	-	-
Type III - all other roofs (e.g., concrete decks with rigid insulation)	0.290	-	-
<b>Walls</b>	0.330	-	-
<b>Floors:</b>			
Type I - parallel-chord trusses and joist-type floors	0.220	-	-
Type II - all other floors (e.g., concrete slabs with rigid insulation)	0.290	-	-

**Table A-3.3.1.1.(3)**  
**Prescriptive Requirements – Solid Masonry Walls**  
 Forming Part of Sentence 3.3.1.1.(3)

Wall Description	Principal Heating Source		
	All Sources	-	-
Solid masonry walls with no interior or exterior finish that incorporates insulation or creates a space that could accommodate insulation	not exempted	-	-

**Table A-3.3.1.2.**  
**Prescriptive Requirements – Fenestration<sup>(1)</sup>**  
 Forming Part of Sentence 3.3.1.2.(1)

Assembly Description	Fenestration-to-Wall Ratio	Principal Heating Source		
		All Sources	-	-
		Maximum Overall Thermal Transmittance (U-value), W/m <sup>2</sup> ·°C		
Fixed Glazing without Sash	up to 0.4	2.10	-	-
	> 0.4 to 0.5	1.90	-	-
	> 0.5 to 0.6	1.70	-	-
	> 0.6 to 0.7	1.60	-	-
	> 0.7 to 0.8	1.50	-	-
	> 0.8 to 0.9	1.50	-	-
	> 0.9	1.40	-	-
Operable or Fixed Glazing with Sash	up to 0.4	2.80	-	-
	> 0.4 to 0.5	2.50	-	-
	> 0.5 to 0.6	2.20	-	-
	> 0.6 to 0.7	2.10	-	-
	> 0.7 to 0.8	1.90	-	-
	> 0.8 to 0.9	1.80	-	-
	> 0.9	1.70	-	-

**Notes to Table A-3.3.1.2.:**

(1) See Appendix Note A-3.3.1.2.(1)

**Table A-5.3.4.3.**  
**Prescriptive Requirements – Heat Recovery**  
 Forming Part of Sentence 5.3.4.3.(1)

Description	Principal Heating Source		
	All Sources	-	-
Heat recovery on principal exhaust component of the mechanical ventilation system in dwelling units	required	-	-

## Region B – (existing Zones B, C and D)

**Table A-3.2.3.1.**  
**Mandatory Provisions – Building Assemblies in Contact with the Ground**  
 Forming Part of Sentences 3.2.3.1.(1), 3.2.3.2.(1) and 3.2.3.3.(1) and (2)

Assembly Description	Principal Heating Source		
	All Sources	-	-
	Minimum Effective Thermal Resistance (RSI-value), m <sup>2</sup> ·°C/W		
<b>Walls and Roofs:</b>			
Type I - finished	2.70	-	-
Type II - otherwise unfinished	2.70	-	-
<b>Floors-on-ground:</b>			
Type I - with imbedded heating cables, ducts or pipes (e.g., radiant heating slabs)	1.08 @ full floor area	-	-
Type II - other floors-on-ground less than 0.6 m below grade (e.g., concrete slab with rigid insulation)	1.08 @ perimeter	-	-

**Table A-3.3.1.1.(1)**  
**Prescriptive Requirements – Above-ground Building Assemblies**  
 Forming Part of Sentence 3.3.1.1.(1)

Assembly Description	Principal Heating Source		
	All Sources	-	-
	Maximum Overall Thermal Transmittance (U-value), W/m <sup>2</sup> ·°C		
<b>Roofs (See Appendix Note A-3.3.1.1.(1)):</b>			
Type I - attic-type roofs	0.120	-	-
Type II - parallel-chord trusses and joist-type roofs	0.230	-	-
Type III - all other roofs (e.g., concrete decks with rigid insulation)	0.290	-	-
<b>Walls</b>	0.300	-	-
<b>Floors:</b>			
Type I - parallel-chord trusses and joist-type floors	0.220	-	-
Type II - all other floors (e.g., concrete slabs with rigid insulation)	0.290	-	-

**Table A-3.3.1.1.(3)**  
**Prescriptive Requirements – Solid Masonry Walls**  
 Forming Part of Sentence 3.3.1.1.(3)

Wall Description	Principal Heating Source		
	All Sources	-	-
Solid masonry walls with no interior or exterior finish that incorporates insulation or creates a space that could accommodate insulation	not exempted	-	-

**Table A-3.3.1.2.**  
**Prescriptive Requirements – Fenestration<sup>(1)</sup>**  
 Forming Part of Sentence 3.3.1.2.(1)

Assembly Description	Fenestration-to-Wall Ratio	Principal Heating Source		
		All Sources	-	-
		Maximum Overall Thermal Transmittance (U-value), W/m <sup>2</sup> ·°C		
Fixed Glazing without Sash	up to 0.4	2.10	-	-
	> 0.4 to 0.5	1.90	-	-
	> 0.5 to 0.6	1.80	-	-
	> 0.6 to 0.7	1.70	-	-
	> 0.7 to 0.8	1.60	-	-
	> 0.8 to 0.9	1.50	-	-
	> 0.9	1.50	-	-
Operable or Fixed Glazing with Sash	up to 0.4	2.80	-	-
	> 0.4 to 0.5	2.50	-	-
	> 0.5 to 0.6	2.30	-	-
	> 0.6 to 0.7	2.10	-	-
	> 0.7 to 0.8	2.00	-	-
	> 0.8 to 0.9	1.90	-	-
	> 0.9	1.80	-	-

**Notes to Table A-3.3.1.2.:**

(1) See Appendix Note A-3.3.1.2.(1)

**Table A-5.3.4.3.**  
**Prescriptive Requirements – Heat Recovery**  
 Forming Part of Sentence 5.3.4.3.(1)

Description	Principal Heating Source		
	All Sources	-	-
Heat recovery on principal exhaust component of the mechanical ventilation system in dwelling units	required	-	-

## Region C – (existing Zones E and F)

**Table A-3.2.3.1.**  
**Mandatory Provisions – Building Assemblies in Contact with the Ground**  
 Forming Part of Sentences 3.2.3.1.(1), 3.2.3.2.(1) and 3.2.3.3.(1) and (2)

Assembly Description	Principal Heating Source		
	All Sources	-	-
	Minimum Effective Thermal Resistance (RSI-value), m <sup>2</sup> ·°C/W		
<b>Walls and Roofs:</b>			
Type I - finished	3.10	-	-
Type II - otherwise unfinished	3.10	-	-
<b>Floors-on-ground:</b>			
Type I - with imbedded heating cables, ducts or pipes (e.g., radiant heating slabs)	1.90 @ full floor area	-	-
Type II - other floors-on-ground less than 0.6 m below grade (e.g., concrete slab with rigid insulation)	1.50 @ perimeter	-	-

**Table A-3.3.1.1.(1)**  
**Prescriptive Requirements – Above-ground Building Assemblies**  
 Forming Part of Sentence 3.3.1.1.(1)

Assembly Description	Principal Heating Source		
	All Sources	-	-
	Maximum Overall Thermal Transmittance (U-value), W/m <sup>2</sup> ·°C		
<b>Roofs (See Appendix Note A-3.3.1.1.(1)):</b>			
Type I - attic-type roofs	0.100	-	-
Type II - parallel-chord trusses and joist-type roofs	0.200	-	-
Type III - all other roofs (e.g., concrete decks with rigid insulation)	0.250	-	-
<b>Walls</b>	0.270	-	-
<b>Floors:</b>			
Type I - parallel-chord trusses and joist-type floors	0.200	-	-
Type II - all other floors (e.g., concrete slabs with rigid insulation)	0.250	-	-

**Table A-3.3.1.1.(3)**  
**Prescriptive Requirements – Solid Masonry Walls**  
 Forming Part of Sentence 3.3.1.1.(3)

Wall Description	Principal Heating Source		
	All Sources	-	-
Solid masonry walls with no interior or exterior finish that incorporates insulation or creates a space that could accommodate insulation	not exempted	-	-

**Table A-3.3.1.2.**  
**Prescriptive Requirements – Fenestration<sup>(1)</sup>**  
 Forming Part of Sentence 3.3.1.2.(1)

Assembly Description	Fenestration-to-Wall Ratio	Principal Heating Source		
		All Sources	-	-
		Maximum Overall Thermal Transmittance (U-value), W/m <sup>2</sup> ·°C		
Fixed Glazing without Sash	up to 0.4	1.80	-	-
	> 0.4 to 0.5	1.70	-	-
	> 0.5 to 0.6	1.60	-	-
	> 0.6 to 0.7	1.50	-	-
	> 0.7 to 0.8	1.50	-	-
	> 0.8 to 0.9	1.40	-	-
	> 0.9	1.40	-	-
Operable or Fixed Glazing with Sash	up to 0.4	1.90	-	-
	> 0.4 to 0.5	1.80	-	-
	> 0.5 to 0.6	1.70	-	-
	> 0.6 to 0.7	1.60	-	-
	> 0.7 to 0.8	1.50	-	-
	> 0.8 to 0.9	1.40	-	-
	> 0.9	1.40	-	-

**Notes to Table A-3.3.1.2.:**

(1) See Appendix Note A-3.3.1.2.(1)

**Table A-5.3.4.3.**  
**Prescriptive Requirements – Heat Recovery**  
 Forming Part of Sentence 5.3.4.3.(1)

Description	Principal Heating Source		
	All Sources	-	-
Heat recovery on principal exhaust component of the mechanical ventilation system in dwelling units	required	-	-

# Ontario

## Region A – < 5000 Degree-days

**Table A-3.2.3.1.**  
**Mandatory Provisions – Building Assemblies in Contact with the Ground**  
 Forming Part of Sentences 3.2.3.1.(1), 3.2.3.2.(1) and 3.2.3.3.(1) and (2)

Assembly Description	Principal Heating Source		
	Electricity, Other	Oil, Propane, Heat Pump	Natural Gas
	Minimum Effective Thermal Resistance (RSI-value), m <sup>2</sup> ·°C/W		
<b>Walls and Roofs:</b>			
Type I - finished	2.40	1.70	1.30
Type II - otherwise unfinished	2.40	no insulation required	no insulation required
<b>Floors-on-ground:</b>			
Type I - with imbedded heating cables, ducts or pipes (e.g., radiant heating slabs)	1.08 @ full floor area	1.08 @ full floor area	1.08 @ full floor area
Type II - other floors-on-ground less than 0.6 m below grade (e.g., concrete slab with rigid insulation)	1.08 @ perimeter	no insulation required	no insulation required

**Table A-3.3.1.1.(1)**  
**Prescriptive Requirements – Above-ground Building Assemblies**  
 Forming Part of Sentence 3.3.1.1.(1)

Assembly Description	Principal Heating Source		
	Electricity, Other	Oil, Propane, Heat Pump	Natural Gas
	Maximum Overall Thermal Transmittance (U-value), W/m <sup>2</sup> ·°C		
<b>Roofs (See Appendix Note A-3.3.1.1.(1)):</b>			
Type I - attic-type roofs	0.140	0.200	0.200
Type II - parallel-chord trusses and joist-type roofs	0.230	0.230	0.230
Type III - all other roofs (e.g., concrete decks with rigid insulation)	0.290	0.410	0.470
<b>Walls</b>	0.330	0.480	0.550
<b>Floors:</b>			
Type I - parallel-chord trusses and joist-type floors	0.220	0.220	0.220
Type II - all other floors (e.g., concrete slabs with rigid insulation)	0.290	0.410	0.470

**Table A-3.3.1.1.(3)**  
**Prescriptive Requirements – Solid Masonry Walls**  
 Forming Part of Sentence 3.3.1.1.(3)

Wall Description	Principal Heating Source		
	Electricity, Other	Oil, Propane, Heat Pump	Natural Gas
Solid masonry walls with no interior or exterior finish that incorporates insulation or creates a space that could accommodate insulation	not exempted	exempted	exempted

**Table A-3.3.1.2.**  
**Prescriptive Requirements – Fenestration<sup>(1)</sup>**  
 Forming Part of Sentence 3.3.1.2.(1)

Assembly Description	Fenestration-to-Wall Ratio	Principal Heating Source		
		Electricity, Other	Oil, Propane, Heat Pump	Natural Gas
		Maximum Overall Thermal Transmittance (U-value), W/m <sup>2</sup> .°C		
Fixed Glazing without Sash	up to 0.4	2.10	3.20	3.20
	> 0.4 to 0.5	1.80	2.70	2.80
	> 0.5 to 0.6	1.70	2.40	2.40
	> 0.6 to 0.7	1.60	2.20	2.20
	> 0.7 to 0.8	1.50	2.00	2.00
	> 0.8 to 0.9	1.40	1.80	1.90
	> 0.9	1.30	1.70	1.80
Operable or Fixed Glazing with Sash	up to 0.4	2.80	3.40	3.40
	> 0.4 to 0.5	2.40	2.90	2.90
	> 0.5 to 0.6	2.20	2.50	2.50
	> 0.6 to 0.7	2.00	2.30	2.30
	> 0.7 to 0.8	1.90	2.10	2.10
	> 0.8 to 0.9	1.70	1.90	1.90
	> 0.9	1.70	1.80	1.80

**Notes to Table A-3.3.1.2.:**

(1) See Appendix Note A-3.3.1.2.(1)

**Table A-5.3.4.3.**  
**Prescriptive Requirements – Heat Recovery**  
 Forming Part of Sentence 5.3.4.3.(1)

Description	Principal Heating Source		
	Electricity, Other	Oil, Propane, Heat Pump	Natural Gas
Heat recovery on principal exhaust component of the mechanical ventilation system in dwelling units	required	-	-

**Region B – ≥ 5000 Degree-days**

**Table A-3.2.3.1.**  
**Mandatory Provisions – Building Assemblies in Contact with the Ground**  
 Forming Part of Sentences 3.2.3.1.(1), 3.2.3.2.(1) and 3.2.3.3.(1) and (2)

Assembly Description	Principal Heating Source		
	Electricity, Other	Oil, Propane, Heat Pump	Natural Gas
	Minimum Effective Thermal Resistance (RSI-value), m <sup>2</sup> ·°C/W		
<b>Walls and Roofs:</b>			
Type I - finished	2.70	2.00	1.70
Type II - otherwise unfinished	2.70	2.00	no insulation required
<b>Floors-on-ground:</b>			
Type I - with imbedded heating cables, ducts or pipes (e.g., radiant heating slabs)	1.50 @ full floor area	1.08 @ full floor area	1.08 @ full floor area
Type II - other floors-on-ground less than 0.6 m below grade (e.g., concrete slab with rigid insulation)	1.08 @ perimeter	1.08 @ perimeter	no insulation required

**Table A-3.3.1.1.(1)**  
**Prescriptive Requirements – Above-ground Building Assemblies**  
 Forming Part of Sentence 3.3.1.1.(1)

Assembly Description	Principal Heating Source		
	Electricity, Other	Oil, Propane, Heat Pump	Natural Gas
	Maximum Overall Thermal Transmittance (U-value), W/m <sup>2</sup> ·°C		
<b>Roofs (See Appendix Note A-3.3.1.1.(1)):</b>			
Type I - attic-type roofs	0.120	0.180	0.200
Type II - parallel-chord trusses and joist-type roofs	0.200	0.230	0.230
Type III - all other roofs (e.g., concrete decks with rigid insulation)	0.270	0.350	0.410
<b>Walls</b>	0.270	0.370	0.480
<b>Floors:</b>			
Type I - parallel-chord trusses and joist-type floors	0.200	0.220	0.220
Type II - all other floors (e.g., concrete slabs with rigid insulation)	0.270	0.350	0.410

**Table A-3.3.1.1.(3)**  
**Prescriptive Requirements – Solid Masonry Walls**  
 Forming Part of Sentence 3.3.1.1.(3)

Wall Description	Principal Heating Source		
	Electricity, Other	Oil, Propane, Heat Pump	Natural Gas
Solid masonry walls with no interior or exterior finish that incorporates insulation or creates a space that could accommodate insulation	not exempted	exempted	exempted

**Table A-3.3.1.2.**  
**Prescriptive Requirements – Fenestration<sup>(1)</sup>**  
 Forming Part of Sentence 3.3.1.2.(1)

Assembly Description	Fenestration-to-Wall Ratio	Principal Heating Source		
		Electricity, Other	Oil, Propane, Heat Pump	Natural Gas
		Maximum Overall Thermal Transmittance (U-value), W/m <sup>2</sup> .°C		
Fixed Glazing without Sash	up to 0.4	1.80	3.20	3.20
	> 0.4 to 0.5	1.70	2.80	2.80
	> 0.5 to 0.6	1.60	2.50	2.50
	> 0.6 to 0.7	1.50	2.30	2.30
	> 0.7 to 0.8	1.50	2.20	2.10
	> 0.8 to 0.9	1.40	2.00	2.00
	> 0.9	1.40	1.90	1.90
Operable or Fixed Glazing with Sash	up to 0.4	2.80	3.40	3.40
	> 0.4 to 0.5	2.50	3.00	2.90
	> 0.5 to 0.6	2.30	2.70	2.60
	> 0.6 to 0.7	2.10	2.40	2.40
	> 0.7 to 0.8	2.00	2.20	2.20
	> 0.8 to 0.9	1.90	2.10	2.10
	> 0.9	1.80	2.00	1.90

**Notes to Table A-3.3.1.2.:**

(1) See Appendix Note A-3.3.1.2.(1)

**Table A-5.3.4.3.**  
**Prescriptive Requirements – Heat Recovery**  
 Forming Part of Sentence 5.3.4.3.(1)

Description	Principal Heating Source		
	Electricity, Other	Oil, Propane, Heat Pump	Natural Gas
Heat recovery on principal exhaust component of the mechanical ventilation system in dwelling units	required	-	-

# Manitoba

## Region A – South of the 53rd Parallel (< 6500 Degree-days approx.)

**Table A-3.2.3.1.**  
**Mandatory Provisions – Building Assemblies in Contact with the Ground**  
 Forming Part of Sentences 3.2.3.1.(1), 3.2.3.2.(1) and 3.2.3.3.(1) and (2)

Assembly Description	Principal Heating Source		
	Electricity, Oil, Propane, Other	Natural Gas, Heat Pump	-
	Minimum Effective Thermal Resistance (RSI-value), m <sup>2</sup> ·°C/W		
<b>Walls and Roofs:</b>			
Type I - finished	2.40	2.00	-
Type II - otherwise unfinished	2.40	2.00	-
<b>Floors-on-ground:</b>			
Type I - with imbedded heating cables, ducts or pipes (e.g., radiant heating slabs)	1.08 @ full floor area	1.08 @ full floor area	-
Type II - other floors-on-ground less than 0.6 m below grade (e.g., concrete slab with rigid insulation)	1.08 @ perimeter	1.08 @ perimeter	-

**Table A-3.3.1.1.(1)**  
**Prescriptive Requirements – Above-ground Building Assemblies**  
 Forming Part of Sentence 3.3.1.1.(1)

Assembly Description	Principal Heating Source		
	Electricity, Oil, Propane, Other	Natural Gas, Heat Pump	-
	Maximum Overall Thermal Transmittance (U-value), W/m <sup>2</sup> ·°C		
<b>Roofs (See Appendix Note A-3.3.1.1.(1)):</b>			
Type I - attic-type roofs	0.140	0.180	-
Type II - parallel-chord trusses and joist-type roofs	0.230	0.230	-
Type III - all other roofs (e.g., concrete decks with rigid insulation)	0.290	0.350	-
<b>Walls</b>	0.330	0.370	-
<b>Floors:</b>			
Type I - parallel-chord trusses and joist-type floors	0.220	0.220	-
Type II - all other floors (e.g., concrete slabs with rigid insulation)	0.290	0.350	-

**Table A-3.3.1.1.(3)**  
**Prescriptive Requirements – Solid Masonry Walls**  
 Forming Part of Sentence 3.3.1.1.(3)

Wall Description	Principal Heating Source		
	Electricity, Oil, Propane, Other	Natural Gas, Heat Pump	-
Solid masonry walls with no interior or exterior finish that incorporates insulation or creates a space that could accommodate insulation	not exempted	exempted	-

**Table A-3.3.1.2.**  
**Prescriptive Requirements – Fenestration<sup>(1)</sup>**  
 Forming Part of Sentence 3.3.1.2.(1)

Assembly Description	Fenestration-to-Wall Ratio	Principal Heating Source		
		Electricity, Oil, Propane, Other	Natural Gas, Heat Pump	-
		Maximum Overall Thermal Transmittance (U-value), W/m <sup>2</sup> .°C		
Fixed Glazing without Sash	up to 0.4	2.10	2.10	-
	> 0.4 to 0.5	1.90	1.80	-
	> 0.5 to 0.6	1.70	1.70	-
	> 0.6 to 0.7	1.60	1.60	-
	> 0.7 to 0.8	1.50	1.50	-
	> 0.8 to 0.9	1.40	1.40	-
	> 0.9	1.40	1.30	-
Operable or Fixed Glazing with Sash	up to 0.4	2.80	3.40	-
	> 0.4 to 0.5	2.40	2.90	-
	> 0.5 to 0.6	2.20	2.60	-
	> 0.6 to 0.7	2.00	2.40	-
	> 0.7 to 0.8	1.90	2.20	-
	> 0.8 to 0.9	1.80	2.00	-
	> 0.9	1.70	1.90	-

**Notes to Table A-3.3.1.2.:**

(1) See Appendix Note A-3.3.1.2.(1)

**Table A-5.3.4.3.**  
**Prescriptive Requirements – Heat Recovery**  
 Forming Part of Sentence 5.3.4.3.(1)

Description	Principal Heating Source		
	Electricity, Oil, Propane, Other	Natural Gas, Heat Pump	-
Heat recovery on principal exhaust component of the mechanical ventilation system in dwelling units	required	-	-

## Region B – At or North of the 53rd Parallel

**Table A-3.2.3.1.**  
**Mandatory Provisions – Building Assemblies in Contact with the Ground**  
 Forming Part of Sentences 3.2.3.1.(1), 3.2.3.2.(1) and 3.2.3.3.(1) and (2)

Assembly Description	Principal Heating Source		
	Electricity, Oil, Propane, Other	Natural Gas, Heat Pump	-
	Minimum Effective Thermal Resistance (RSI-value), m <sup>2</sup> ·°C/W		
<b>Walls and Roofs:</b>			
Type I - finished	2.70	2.40	-
Type II - otherwise unfinished	2.70	2.40	-
<b>Floors-on-ground:</b>			
Type I - with imbedded heating cables, ducts or pipes (e.g., radiant heating slabs)	1.50 @ full floor area	1.08 @ full floor area	-
Type II - other floors-on-ground less than 0.6 m below grade (e.g., concrete slab with rigid insulation)	1.08 @ perimeter	1.08 @ perimeter	-

**Table A-3.3.1.1.(1)**  
**Prescriptive Requirements – Above-ground Building Assemblies**  
 Forming Part of Sentence 3.3.1.1.(1)

Assembly Description	Principal Heating Source		
	Electricity, Oil, Propane, Other	Natural Gas, Heat Pump	-
	Maximum Overall Thermal Transmittance (U-value), W/m <sup>2</sup> ·°C		
<b>Roofs (See Appendix Note A-3.3.1.1.(1)):</b>			
Type I - attic-type roofs	0.120	0.140	-
Type II - parallel-chord trusses and joist-type roofs	0.200	0.230	-
Type III - all other roofs (e.g., concrete decks with rigid insulation)	0.270	0.290	-
<b>Walls</b>	0.270	0.370	-
<b>Floors:</b>			
Type I - parallel-chord trusses and joist-type floors	0.200	0.220	-
Type II - all other floors (e.g., concrete slabs with rigid insulation)	0.270	0.290	-

**Table A-3.3.1.1.(3)**  
**Prescriptive Requirements – Solid Masonry Walls**  
 Forming Part of Sentence 3.3.1.1.(3)

Wall Description	Principal Heating Source		
	Electricity, Oil, Propane, Other	Natural Gas, Heat Pump	-
Solid masonry walls with no interior or exterior finish that incorporates insulation or creates a space that could accommodate insulation	not exempted	exempted	-

**Table A-3.3.1.2.**  
**Prescriptive Requirements – Fenestration<sup>(1)</sup>**  
 Forming Part of Sentence 3.3.1.2.(1)

Assembly Description	Fenestration-to-Wall Ratio	Principal Heating Source		
		Electricity, Oil, Propane, Other	Natural Gas, Heat Pump	-
		Maximum Overall Thermal Transmittance (U-value), W/m <sup>2</sup> .°C		
Fixed Glazing without Sash	up to 0.4	1.80	2.10	-
	> 0.4 to 0.5	1.70	1.90	-
	> 0.5 to 0.6	1.60	1.70	-
	> 0.6 to 0.7	1.50	1.60	-
	> 0.7 to 0.8	1.50	1.60	-
	> 0.8 to 0.9	1.40	1.50	-
	> 0.9	1.40	1.40	-
Operable or Fixed Glazing with Sash	up to 0.4	2.80	2.80	-
	> 0.4 to 0.5	2.50	2.50	-
	> 0.5 to 0.6	2.20	2.20	-
	> 0.6 to 0.7	2.10	2.10	-
	> 0.7 to 0.8	2.00	1.90	-
	> 0.8 to 0.9	1.90	1.80	-
	> 0.9	1.80	1.80	-

**Notes to Table A-3.3.1.2.:**

(1) See Appendix Note A-3.3.1.2.(1)

**Table A-5.3.4.3.**  
**Prescriptive Requirements – Heat Recovery**  
 Forming Part of Sentence 5.3.4.3.(1)

Description	Principal Heating Source		
	Electricity, Oil, Propane, Other	Natural Gas, Heat Pump	-
Heat recovery on principal exhaust component of the mechanical ventilation system in dwelling units	required	required	-

# Saskatchewan

## Region A – Saskatchewan

**Table A-3.2.3.1.**  
**Mandatory Provisions – Building Assemblies in Contact with the Ground**  
 Forming Part of Sentences 3.2.3.1.(1), 3.2.3.2.(1) and 3.2.3.3.(1) and (2)

Assembly Description	Principal Heating Source		
	Electricity, Oil, Propane, Other	Natural Gas, Heat Pump	-
	Minimum Effective Thermal Resistance (RSI-value), m <sup>2</sup> ·°C/W		
<b>Walls and Roofs:</b>			
Type I - finished	3.10	1.70	-
Type II - otherwise unfinished	3.10	no insulation required	-
<b>Floors-on-ground:</b>			
Type I - with imbedded heating cables, ducts or pipes (e.g., radiant heating slabs)	1.50 @ full floor area	1.08 @ full floor area	-
Type II - other floors-on-ground less than 0.6 m below grade (e.g., concrete slab with rigid insulation)	1.08 @ perimeter	no insulation required	-

**Table A-3.3.1.1.(1)**  
**Prescriptive Requirements – Above-ground Building Assemblies**  
 Forming Part of Sentence 3.3.1.1.(1)

Assembly Description	Principal Heating Source		
	Electricity, Oil, Propane, Other	Natural Gas, Heat Pump	-
	Maximum Overall Thermal Transmittance (U-value), W/m <sup>2</sup> ·°C		
<b>Roofs (See Appendix Note A-3.3.1.1.(1)):</b>			
Type I - attic-type roofs	0.100	0.200	-
Type II - parallel-chord trusses and joist-type roofs	0.200	0.230	-
Type III - all other roofs (e.g., concrete decks with rigid insulation)	0.250	0.410	-
<b>Walls</b>	0.270	0.480	-
<b>Floors:</b>			
Type I - parallel-chord trusses and joist-type floors	0.200	0.220	-
Type II - all other floors (e.g., concrete slabs with rigid insulation)	0.250	0.410	-

**Table A-3.3.1.1.(3)**  
**Prescriptive Requirements – Solid Masonry Walls**  
 Forming Part of Sentence 3.3.1.1.(3)

Wall Description	Principal Heating Source		
	Electricity, Oil, Propane, Other	Natural Gas, Heat Pump	-
Solid masonry walls with no interior or exterior finish that incorporates insulation or creates a space that could accommodate insulation	not exempted	exempted	-

**Table A-3.3.1.2.**  
**Prescriptive Requirements – Fenestration<sup>(1)</sup>**  
 Forming Part of Sentence 3.3.1.2.(1)

Assembly Description	Fenestration-to-Wall Ratio	Principal Heating Source		
		Electricity, Oil, Propane, Other	Natural Gas, Heat Pump	-
		Maximum Overall Thermal Transmittance (U-value), W/m <sup>2</sup> .°C		
Fixed Glazing without Sash	up to 0.4	1.80	3.20	-
	> 0.4 to 0.5	1.70	2.70	-
	> 0.5 to 0.6	1.60	2.40	-
	> 0.6 to 0.7	1.50	2.20	-
	> 0.7 to 0.8	1.40	2.00	-
	> 0.8 to 0.9	1.30	1.80	-
	> 0.9	1.30	1.70	-
Operable or Fixed Glazing with Sash	up to 0.4	1.90	3.40	-
	> 0.4 to 0.5	1.70	2.90	-
	> 0.5 to 0.6	1.60	2.50	-
	> 0.6 to 0.7	1.50	2.30	-
	> 0.7 to 0.8	1.40	2.10	-
	> 0.8 to 0.9	1.30	1.90	-
	> 0.9	1.30	1.80	-

**Notes to Table A-3.3.1.2.:**  
 (1) See Appendix Note A-3.3.1.2.(1)

**Table A-5.3.4.3.**  
**Prescriptive Requirements – Heat Recovery**  
 Forming Part of Sentence 5.3.4.3.(1)

Description	Principal Heating Source		
	Electricity, Oil, Propane, Other	Natural Gas, Heat Pump	-
Heat recovery on principal exhaust component of the mechanical ventilation system in dwelling units	required	-	-

# Alberta

## Region A – Calgary/Lethbridge

**Table A-3.2.3.1.**  
**Mandatory Provisions – Building Assemblies in Contact with the Ground**  
 Forming Part of Sentences 3.2.3.1.(1), 3.2.3.2.(1) and 3.2.3.3.(1) and (2)

Assembly Description	Principal Heating Source		
	Electricity, Other	Propane, Oil, Heat Pump	Natural Gas
	Minimum Effective Thermal Resistance (RSI-value), m <sup>2</sup> ·°C/W		
<b>Walls and Roofs:</b>			
Type I - finished	2.70	2.70	1.70
Type II - otherwise unfinished	2.70	2.70	no insulation required
<b>Floors-on-ground:</b>			
Type I - with imbedded heating cables, ducts or pipes (e.g., radiant heating slabs)	1.50 @ full floor area	1.08 @ full floor area	1.08 @ full floor area
Type II - other floors-on-ground less than 0.6 m below grade (e.g., concrete slab with rigid insulation)	1.08 @ perimeter	1.08 @ perimeter	no insulation required

**Table A-3.3.1.1.(1)**  
**Prescriptive Requirements – Above-ground Building Assemblies**  
 Forming Part of Sentence 3.3.1.1.(1)

Assembly Description	Principal Heating Source		
	Electricity, Other	Propane, Oil, Heat Pump	Natural Gas
	Maximum Overall Thermal Transmittance (U-value), W/m <sup>2</sup> ·°C		
<b>Roofs (See Appendix Note A-3.3.1.1.(1)):</b>			
Type I - attic-type roofs	0.140	0.140	0.200
Type II - parallel-chord trusses and joist-type roofs	0.230	0.230	0.230
Type III - all other roofs (e.g., concrete decks with rigid insulation)	0.290	0.290	0.470
<b>Walls</b>	0.330	0.330	0.550
<b>Floors:</b>			
Type I - parallel-chord trusses and joist-type floors	0.220	0.220	0.220
Type II - all other floors (e.g., concrete slabs with rigid insulation)	0.290	0.290	0.470

**Table A-3.3.1.1.(3)**  
**Prescriptive Requirements – Solid Masonry Walls**  
 Forming Part of Sentence 3.3.1.1.(3)

Wall Description	Principal Heating Source		
	Electricity, Other	Propane, Oil, Heat Pump	Natural Gas
Solid masonry walls with no interior or exterior finish that incorporates insulation or creates a space that could accommodate insulation	not exempted	not exempted	exempted

**Table A-3.3.1.2.**  
**Prescriptive Requirements – Fenestration<sup>(1)</sup>**  
 Forming Part of Sentence 3.3.1.2.(1)

Assembly Description	Fenestration-to-Wall Ratio	Principal Heating Source		
		Electricity, Other	Propane, Oil, Heat Pump	Natural Gas
		Maximum Overall Thermal Transmittance (U-value), W/m <sup>2</sup> .°C		
Fixed Glazing without Sash	up to 0.4	2.10	2.10	3.20
	> 0.4 to 0.5	1.90	1.90	2.80
	> 0.5 to 0.6	1.80	1.80	2.50
	> 0.6 to 0.7	1.70	1.70	2.30
	> 0.7 to 0.8	1.60	1.60	2.20
	> 0.8 to 0.9	1.50	1.50	2.00
	> 0.9	1.40	1.40	1.90
Operable or Fixed Glazing with Sash	up to 0.4	2.80	2.80	3.40
	> 0.4 to 0.5	2.50	2.50	3.00
	> 0.5 to 0.6	2.30	2.30	2.70
	> 0.6 to 0.7	2.10	2.10	2.40
	> 0.7 to 0.8	2.00	2.00	2.30
	> 0.8 to 0.9	1.90	1.90	2.10
	> 0.9	1.80	1.80	2.00

**Notes to Table A-3.3.1.2.:**

(1) See Appendix Note A-3.3.1.2.(1)

**Table A-5.3.4.3.**  
**Prescriptive Requirements – Heat Recovery**  
 Forming Part of Sentence 5.3.4.3.(1)

Description	Principal Heating Source		
	Electricity, Other	Propane, Oil, Heat Pump	Natural Gas
Heat recovery on principal exhaust component of the mechanical ventilation system in dwelling units	required	required	-

**Region B – Red Deer/Edmonton/Grande Prairie**

**Table A-3.2.3.1.**  
**Mandatory Provisions – Building Assemblies in Contact with the Ground**  
 Forming Part of Sentences 3.2.3.1.(1), 3.2.3.2.(1) and 3.2.3.3.(1) and (2)

Assembly Description	Principal Heating Source		
	Electricity, Other	Propane, Oil, Heat Pump	Natural Gas
	Minimum Effective Thermal Resistance (RSI-value), m <sup>2</sup> ·°C/W		
<b>Walls and Roofs:</b>			
Type I - finished	2.70	2.70	1.70
Type II - otherwise unfinished	2.70	2.70	no insulation required
<b>Floors-on-ground:</b>			
Type I - with imbedded heating cables, ducts or pipes (e.g., radiant heating slabs)	1.50 @ full floor area	1.50 @ full floor area	1.08 @ full floor area
Type II - other floors-on-ground less than 0.6 m below grade (e.g., concrete slab with rigid insulation)	1.08 @ perimeter	1.08 @ perimeter	1.08 @ perimeter

**Table A-3.3.1.1.(1)**  
**Prescriptive Requirements – Above-ground Building Assemblies**  
 Forming Part of Sentence 3.3.1.1.(1)

Assembly Description	Principal Heating Source		
	Electricity, Other	Propane, Oil, Heat Pump	Natural Gas
	Maximum Overall Thermal Transmittance (U-value), W/m <sup>2</sup> ·°C		
<b>Roofs (See Appendix Note A-3.3.1.1.(1)):</b>			
Type I - attic-type roofs	0.120	0.120	0.200
Type II - parallel-chord trusses and joist-type roofs	0.230	0.230	0.230
Type III - all other roofs (e.g., concrete decks with rigid insulation)	0.290	0.290	0.410
<b>Walls</b>	0.300	0.300	0.480
<b>Floors:</b>			
Type I - parallel-chord trusses and joist-type floors	0.220	0.220	0.220
Type II - all other floors (e.g., concrete slabs with rigid insulation)	0.290	0.290	0.410

**Table A-3.3.1.1.(3)**  
**Prescriptive Requirements – Solid Masonry Walls**  
 Forming Part of Sentence 3.3.1.1.(3)

Wall Description	Principal Heating Source		
	Electricity, Other	Propane, Oil, Heat Pump	Natural Gas
Solid masonry walls with no interior or exterior finish that incorporates insulation or creates a space that could accommodate insulation	not exempted	not exempted	exempted

**Table A-3.3.1.2.**  
**Prescriptive Requirements – Fenestration<sup>(1)</sup>**  
 Forming Part of Sentence 3.3.1.2.(1)

Assembly Description	Fenestration-to-Wall Ratio	Principal Heating Source		
		Electricity, Other	Propane, Oil, Heat Pump	Natural Gas
		Maximum Overall Thermal Transmittance (U-value), W/m <sup>2</sup> .°C		
Fixed Glazing without Sash	up to 0.4	2.10	2.10	3.20
	> 0.4 to 0.5	1.90	1.90	2.80
	> 0.5 to 0.6	1.80	1.80	2.50
	> 0.6 to 0.7	1.70	1.70	2.30
	> 0.7 to 0.8	1.60	1.60	2.10
	> 0.8 to 0.9	1.50	1.50	2.00
	> 0.9	1.40	1.50	1.90
Operable or Fixed Glazing with Sash	up to 0.4	2.80	2.80	3.40
	> 0.4 to 0.5	2.50	2.50	3.00
	> 0.5 to 0.6	2.30	2.30	2.60
	> 0.6 to 0.7	2.10	2.10	2.40
	> 0.7 to 0.8	2.00	2.00	2.20
	> 0.8 to 0.9	1.90	1.90	2.10
	> 0.9	1.80	1.80	2.00

**Notes to Table A-3.3.1.2.:**

(1) See Appendix Note A-3.3.1.2.(1)

**Table A-5.3.4.3.**  
**Prescriptive Requirements – Heat Recovery**  
 Forming Part of Sentence 5.3.4.3.(1)

Description	Principal Heating Source		
	Electricity, Other	Propane, Oil, Heat Pump	Natural Gas
Heat recovery on principal exhaust component of the mechanical ventilation system in dwelling units	required	required	-

## Region C – Fort McMurray

**Table A-3.2.3.1.**  
**Mandatory Provisions – Building Assemblies in Contact with the Ground**  
 Forming Part of Sentences 3.2.3.1.(1), 3.2.3.2.(1) and 3.2.3.3.(1) and (2)

Assembly Description	Principal Heating Source		
	Electricity, Other	Propane, Oil, Heat Pump	Natural Gas
	Minimum Effective Thermal Resistance (RSI-value), m <sup>2</sup> ·°C/W		
<b>Walls and Roofs:</b>			
Type I - finished	2.70	2.70	1.70
Type II - otherwise unfinished	2.70	2.70	no insulation required
<b>Floors-on-ground:</b>			
Type I - with imbedded heating cables, ducts or pipes (e.g., radiant heating slabs)	1.50 @ full floor area	1.50 @ full floor area	1.08 @ full floor area
Type II - other floors-on-ground less than 0.6 m below grade (e.g., concrete slab with rigid insulation)	1.08 @ perimeter	1.08 @ perimeter	1.08 @ perimeter

**Table A-3.3.1.1.(1)**  
**Prescriptive Requirements – Above-ground Building Assemblies**  
 Forming Part of Sentence 3.3.1.1.(1)

Assembly Description	Principal Heating Source		
	Electricity, Other	Propane, Oil, Heat Pump	Natural Gas
	Maximum Overall Thermal Transmittance (U-value), W/m <sup>2</sup> ·°C		
<b>Roofs (See Appendix Note A-3.3.1.1.(1)):</b>			
Type I - attic-type roofs	0.120	0.120	0.200
Type II - parallel-chord trusses and joist-type roofs	0.230	0.230	0.230
Type III - all other roofs (e.g., concrete decks with rigid insulation)	0.290	0.290	0.410
<b>Walls</b>	0.300	0.300	0.480
<b>Floors:</b>			
Type I - parallel-chord trusses and joist-type roofs	0.220	0.220	0.220
Type II - all other floors (e.g., concrete slabs with rigid insulation)	0.290	0.290	0.410

**Table A-3.3.1.1.(3)**  
**Prescriptive Requirements – Solid Masonry Walls**  
 Forming Part of Sentence 3.3.1.1.(3)

Wall Description	Principal Heating Source		
	Electricity, Other	Propane, Oil, Heat Pump	Natural Gas
Solid masonry walls with no interior or exterior finish that incorporates insulation or creates a space that could accommodate insulation	not exempted	not exempted	exempted

**Table A-3.3.1.2.**  
**Prescriptive Requirements – Fenestration<sup>(1)</sup>**  
 Forming Part of Sentence 3.3.1.2.(1)

Assembly Description	Fenestration-to-Wall Ratio	Principal Heating Source		
		Electricity, Other	Propane, Oil, Heat Pump	Natural Gas
		Maximum Overall Thermal Transmittance (U-value), W/m <sup>2</sup> .°C		
Fixed Glazing without Sash	up to 0.4	1.80	2.10	3.20
	> 0.4 to 0.5	1.70	1.90	2.80
	> 0.5 to 0.6	1.60	1.70	2.50
	> 0.6 to 0.7	1.50	1.60	2.30
	> 0.7 to 0.8	1.40	1.50	2.10
	> 0.8 to 0.9	1.30	1.50	1.90
	> 0.9	1.30	1.40	1.80
Operable or Fixed Glazing with Sash	up to 0.4	2.80	2.80	3.40
	> 0.4 to 0.5	2.40	2.40	2.90
	> 0.5 to 0.6	2.20	2.20	2.60
	> 0.6 to 0.7	2.00	2.10	2.40
	> 0.7 to 0.8	1.90	1.90	2.20
	> 0.8 to 0.9	1.80	1.80	2.00
	> 0.9	1.70	1.70	1.90

**Notes to Table A-3.3.1.2.:**

(1) See Appendix Note A-3.3.1.2.(1)

**Table A-5.3.4.3.**  
**Prescriptive Requirements – Heat Recovery**  
 Forming Part of Sentence 5.3.4.3.(1)

Description	Principal Heating Source		
	Electricity, Other	Propane, Oil, Heat Pump	Natural Gas
Heat recovery on principal exhaust component of the mechanical ventilation system in dwelling units	required	required	-

# British Columbia

## Region A – ≤ 3500 Degree-days, excluding: Vancouver Island, The District of Squamish, the communities of Woodfibre, Port Mellon, Gibsons, Sechelt and Powell River, and Texada Island

Table A-3.2.3.1.  
Mandatory Provisions – Building Assemblies in Contact with the Ground  
Forming Part of Sentences 3.2.3.1.(1), 3.2.3.2.(1) and 3.2.3.3.(1) and (2)

Assembly Description	Principal Heating Source		
	Electricity, Other	Propane, Oil, Heat Pump	Natural Gas
	Minimum Effective Thermal Resistance (RSI-value), m <sup>2</sup> ·°C/W		
<b>Walls and Roofs:</b>			
Type I - finished	1.70	1.30	0.90
Type II - otherwise unfinished	1.70	no insulation required	no insulation required
<b>Floors-on-ground:</b>			
Type I - with imbedded heating cables, ducts or pipes (e.g., radiant heating slabs)	1.08 @ full floor area	1.08 @ full floor area	1.08 @ full floor area
Type II - other floors-on-ground less than 0.6 m below grade (e.g., concrete slab with rigid insulation)	1.08 @ perimeter	no insulation required	no insulation required

**Table A-3.3.1.1.(1)**  
**Prescriptive Requirements – Above-ground Building Assemblies**  
 Forming Part of Sentence 3.3.1.1.(1)

Assembly Description	Principal Heating Source		
	Electricity, Other	Propane, Oil, Heat Pump	Natural Gas
	Maximum Overall Thermal Transmittance (U-value), W/m <sup>2</sup> .°C		
Roofs (See Appendix Note A-3.3.1.1.(1)):			
Type I - attic-type roofs	0.140	0.180	0.180
Type II - parallel-chord trusses and joist-type roofs	0.230	0.230	0.230
Type III - all other roofs (e.g., concrete decks with rigid insulation)	0.410	0.470	0.470
Walls	0.450	0.810	0.810
Floors:			
Type I - parallel-chord trusses and joist-type floors	0.220	0.220	0.220
Type II - all other floors (e.g., concrete slabs with rigid insulation)	0.410	0.470	0.470

**Table A-3.3.1.1.(3)**  
**Prescriptive Requirements – Solid Masonry Walls**  
 Forming Part of Sentence 3.3.1.1.(3)

Wall Description	Principal Heating Source		
	Electricity, Other	Propane, Oil, Heat Pump	Natural Gas
Solid masonry walls with no interior or exterior finish that incorporates insulation or creates a space that could accommodate insulation	exempted	exempted	exempted

**Table A-3.3.1.2.**  
**Prescriptive Requirements – Fenestration<sup>(1)</sup>**  
 Forming Part of Sentence 3.3.1.2.(1)

Assembly Description	Fenestration-to-Wall Ratio	Principal Heating Source		
		Electricity, Other	Propane, Oil, Heat Pump	Natural Gas
		Maximum Overall Thermal Transmittance (U-value), W/m <sup>2</sup> .°C		
Fixed Glazing without Sash	up to 0.4	3.20	3.20	3.20
	> 0.4 to 0.5	2.90	2.90	2.90
	> 0.5 to 0.6	2.60	2.60	2.60
	> 0.6 to 0.7	2.40	2.50	2.40
	> 0.7 to 0.8	2.20	2.30	2.30
	> 0.8 to 0.9	2.10	2.20	2.10
	> 0.9	2.00	2.10	2.00
Operable or Fixed Glazing with Sash	up to 0.4	3.40	3.40	3.40
	> 0.4 to 0.5	3.00	3.00	3.00
	> 0.5 to 0.6	2.70	2.80	2.70
	> 0.6 to 0.7	2.50	2.60	2.50
	> 0.7 to 0.8	2.30	2.40	2.40
	> 0.8 to 0.9	2.20	2.30	2.20
	> 0.9	2.10	2.20	2.10

**Notes to Table A-3.3.1.2.:**

(1) See Appendix Note A-3.3.1.2.(1)

**Table A-5.3.4.3.**  
**Prescriptive Requirements – Heat Recovery**  
 Forming Part of Sentence 5.3.4.3.(1)

Description	Principal Heating Source		
	Electricity, Other	Propane, Oil, Heat Pump	Natural Gas
Heat recovery on principal exhaust component of the mechanical ventilation system in dwelling units	-	-	-

**Region B – ≥ 4500 Degree-days**

**Table A-3.2.3.1.**  
**Mandatory Provisions – Building Assemblies in Contact with the Ground**  
 Forming Part of Sentences 3.2.3.1.(1), 3.2.3.2.(1) and 3.2.3.3.(1) and (2)

Assembly Description	Principal Heating Source		
	Electricity, Other	Propane, Oil, Heat Pump	Natural Gas: BC Gas    PNG
	Minimum Effective Thermal Resistance (RSI-value), m <sup>2</sup> ·°C/W		
<b>Walls and Roofs:</b>			
Type I - finished	2.00	1.70	1.30    1.70
Type II - otherwise unfinished	2.00	1.70	1.30    1.70
<b>Floors-on-ground:</b>			
Type I - with imbedded heating cables, ducts or pipes (e.g., radiant heating slabs)	1.08 @ full floor area	1.08 @ full floor area	1.08    1.08 @ full floor area
Type II - other floors-on-ground less than 0.6 m below grade (e.g., concrete slab with rigid insulation)	1.08 @ perimeter	1.08 @ perimeter	1.08    1.08 @ perimeter

**Table A-3.3.1.1.(1)**  
**Prescriptive Requirements – Above-ground Building Assemblies**  
 Forming Part of Sentence 3.3.1.1.(1)

Assembly Description	Principal Heating Source		
	Electricity, Other	Propane, Oil, Heat Pump	Natural Gas: BC Gas    PNG
	Maximum Overall Thermal Transmittance (U-value), W/m <sup>2</sup> ·°C		
<b>Roofs (See Appendix Note A-3.3.1.1.(1)):</b>			
Type I - attic-type roofs	0.140	0.140	0.180    0.140
Type II - parallel-chord trusses and joist-type roofs	0.230	0.230	0.230    0.230
Type III - all other roofs (e.g., concrete decks with rigid insulation)	0.290	0.290	0.470    0.410
Walls	0.370	0.370	0.450    0.450
<b>Floors:</b>			
Type I - parallel-chord trusses and joist-type floors	0.220	0.220	0.220    0.220
Type II - all other floors (e.g., concrete slabs with rigid insulation)	0.290	0.290	0.470    0.410

**Table A-3.3.1.1.(3)**  
**Prescriptive Requirements – Solid Masonry Walls**  
 Forming Part of Sentence 3.3.1.1.(3)

Wall Description	Principal Heating Source		
	Electricity, Other	Propane, Oil, Heat Pump	Natural Gas
Solid masonry walls with no interior or exterior finish that incorporates insulation or creates a space that could accommodate insulation	exempted	exempted	exempted

**Table A-3.3.1.2.**  
**Prescriptive Requirements – Fenestration<sup>(1)</sup>**  
 Forming Part of Sentence 3.3.1.2.(1)

Assembly Description	Fenestration-to-Wall Ratio	Principal Heating Source		
		Electricity, Other	Propane, Oil, Heat Pump	Natural Gas
		Maximum Overall Thermal Transmittance (U-value), W/m <sup>2</sup> .°C		
Fixed Glazing without Sash	up to 0.4	1.70	1.70	3.20
	> 0.4 to 0.5	1.60	1.60	2.90
	> 0.5 to 0.6	1.50	1.50	2.60
	> 0.6 to 0.7	1.50	1.50	2.40
	> 0.7 to 0.8	1.40	1.40	2.30
	> 0.8 to 0.9	1.40	1.30	2.10
	> 0.9	1.40	1.30	2.00
Operable or Fixed Glazing with Sash	up to 0.4	2.70	3.40	3.40
	> 0.4 to 0.5	2.40	3.00	3.00
	> 0.5 to 0.6	2.20	2.70	2.70
	> 0.6 to 0.7	2.10	2.50	2.50
	> 0.7 to 0.8	2.00	2.30	2.40
	> 0.8 to 0.9	1.90	2.20	2.20
	> 0.9	1.80	2.10	2.10

**Notes to Table A-3.3.1.2.:**

(1) See Appendix Note A-3.3.1.2.(1)

**Table A-5.3.4.3.**  
**Prescriptive Requirements – Heat Recovery**  
 Forming Part of Sentence 5.3.4.3.(1)

Description	Principal Heating Source		
	Electricity, Other	Propane, Oil, Heat Pump	Natural Gas
Heat recovery on principal exhaust component of the mechanical ventilation system in dwelling units	required	-	-

**Region C – Vancouver Island Gas Pipeline Service Area,  
including: Vancouver Island; the District of Squamish; the  
communities of Woodfibre, Port Mellon, Gibsons, Sechelt and  
Powell River; and Texada Island**

**Table A-3.2.3.1.**  
**Mandatory Provisions – Building Assemblies in Contact with the Ground**  
Forming Part of Sentences 3.2.3.1.(1), 3.2.3.2.(1) and 3.2.3.3.(1) and (2)

Assembly Description	Principal Heating Source		
	Electricity, Other	Propane, Oil, Heat Pump	Natural Gas
	Minimum Effective Thermal Resistance (RSI-value), m <sup>2</sup> ·°C/W		
<b>Walls and Roofs:</b>			
Type I - finished	1.70	0.90	0.90
Type II - otherwise unfinished	1.70	no insulation required	no insulation required
<b>Floors-on-ground:</b>			
Type I - with imbedded heating cables, ducts or pipes (e.g., radiant heating slabs)	1.08 @ full floor area	1.08 @ full floor area	1.08 @ full floor area
Type II - other floors-on-ground less than 0.6 m below grade (e.g., concrete slab with rigid insulation)	1.08 @ perimeter	no insulation required	no insulation required

**Table A-3.3.1.1.(1)**  
**Prescriptive Requirements – Above-ground Building Assemblies**  
Forming Part of Sentence 3.3.1.1.(1)

Assembly Description	Principal Heating Source		
	Electricity, Other	Propane, Oil, Heat Pump	Natural Gas
	Maximum Overall Thermal Transmittance (U-value), W/m <sup>2</sup> ·°C		
<b>Roofs (See Appendix Note A-3.3.1.1.(1)):</b>			
Type I - attic-type roofs	0.140	0.180	0.180
Type II - parallel-chord trusses and joist-type roofs	0.230	0.230	0.230
Type III - all other roofs (e.g., concrete decks with rigid insulation)	0.410	0.470	0.470
<b>Walls</b>	0.450	0.810	0.810
<b>Floors:</b>			
Type I - parallel-chord trusses and joist-type floors	0.220	0.220	0.220
Type II - all other floors (e.g., concrete slabs with rigid insulation)	0.410	0.470	0.470

**Table A-3.3.1.1.(3)**  
**Prescriptive Requirements – Solid Masonry Walls**  
 Forming Part of Sentence 3.3.1.1.(3)

Wall Description	Principal Heating Source		
	Electricity, Other	Propane, Oil, Heat Pump	Natural Gas
Solid masonry walls with no interior or exterior finish that incorporates insulation or creates a space that could accommodate insulation	exempted	exempted	exempted

**Table A-3.3.1.2.**  
**Prescriptive Requirements – Fenestration<sup>(1)</sup>**  
 Forming Part of Sentence 3.3.1.2.(1)

Assembly Description	Fenestration-to-Wall Ratio	Principal Heating Source		
		Electricity, Other	Propane, Oil, Heat Pump	Natural Gas
		Maximum Overall Thermal Transmittance (U-value), W/m <sup>2</sup> .°C		
Fixed Glazing without Sash	up to 0.4	3.20	3.20	3.20
	> 0.4 to 0.5	2.90	2.90	2.90
	> 0.5 to 0.6	2.60	2.70	2.70
	> 0.6 to 0.7	2.40	2.50	2.50
	> 0.7 to 0.8	2.30	2.40	2.30
	> 0.8 to 0.9	2.20	2.20	2.20
	> 0.9	2.10	2.20	2.10
Operable or Fixed Glazing with Sash	up to 0.4	3.40	3.40	3.40
	> 0.4 to 0.5	3.00	3.10	3.00
	> 0.5 to 0.6	2.80	2.80	2.80
	> 0.6 to 0.7	2.50	2.60	2.60
	> 0.7 to 0.8	2.40	2.50	2.40
	> 0.8 to 0.9	2.20	2.30	2.30
	> 0.9	2.10	2.20	2.20

**Notes to Table A-3.3.1.2.:**

(1) See Appendix Note A-3.3.1.2.(1)

**Table A-5.3.4.3.**  
**Prescriptive Requirements – Heat Recovery**  
 Forming Part of Sentence 5.3.4.3.(1)

Description	Principal Heating Source		
	Electricity, Other	Propane, Oil, Heat Pump	Natural Gas
Heat recovery on principal exhaust component of the mechanical ventilation system in dwelling units	-	-	-

**Region D – 3501 to 4500 Degree-days, B.C. Hydro Service Area**

**Table A-3.2.3.1.**  
**Mandatory Provisions – Building Assemblies in Contact with the Ground**  
 Forming Part of Sentences 3.2.3.1.(1), 3.2.3.2.(1) and 3.2.3.3.(1) and (2)

Assembly Description	Principal Heating Source		
	Electricity, Other	Propane, Oil, Heat Pump	Natural Gas
	Minimum Effective Thermal Resistance (RSI-value), m <sup>2</sup> ·°C/W		
<b>Walls and Roofs:</b>			
Type I - finished	1.70	1.30	0.90
Type II - otherwise unfinished	1.70	1.30	no insulation required
<b>Floors-on-ground:</b>			
Type I - with imbedded heating cables, ducts or pipes (e.g., radiant heating slabs)	1.08 @ full floor area	1.08 @ full floor area	1.08 @ full floor area
Type II - other floors-on-ground less than 0.6 m below grade (e.g., concrete slab with rigid insulation)	1.08 @ perimeter	1.08 @ perimeter	no insulation required

**Table A-3.3.1.1.(1)**  
**Prescriptive Requirements – Above-ground Building Assemblies**  
 Forming Part of Sentence 3.3.1.1.(1)

Assembly Description	Principal Heating Source		
	Electricity, Other	Propane, Oil, Heat Pump	Natural Gas
	Maximum Overall Thermal Transmittance (U-value), W/m <sup>2</sup> ·°C		
<b>Roofs (See Appendix Note A-3.3.1.1.(1)):</b>			
Type I - attic-type roofs	0.140	0.180	0.180
Type II - parallel-chord trusses and joist-type roofs	0.230	0.230	0.230
Type III - all other roofs (e.g., concrete decks with rigid insulation)	0.290	0.470	0.470
<b>Walls</b>	0.370	0.450	0.810
<b>Floors:</b>			
Type I - parallel-chord trusses and joist-type floors	0.220	0.220	0.220
Type II - all other floors (e.g., concrete slabs with rigid insulation)	0.290	0.470	0.470

**Table A-3.3.1.1.(3)**  
**Prescriptive Requirements – Solid Masonry Walls**  
 Forming Part of Sentence 3.3.1.1.(3)

Wall Description	Principal Heating Source		
	Electricity, Other	Propane, Oil, Heat Pump	Natural Gas
Solid masonry walls with no interior or exterior finish that incorporates insulation or creates a space that could accommodate insulation	exempted	exempted	exempted

**Table A-3.3.1.2.**  
**Prescriptive Requirements – Fenestration<sup>(1)</sup>**  
 Forming Part of Sentence 3.3.1.2.(1)

Assembly Description	Fenestration-to-Wall Ratio	Principal Heating Source		
		Electricity, Other	Propane, Oil, Heat Pump	Natural Gas
		Maximum Overall Thermal Transmittance (U-value), W/m <sup>2</sup> .°C		
Fixed Glazing without Sash	up to 0.4	1.70	3.20	3.20
	> 0.4 to 0.5	1.50	2.80	2.80
	> 0.5 to 0.6	1.40	2.50	2.50
	> 0.6 to 0.7	1.30	2.30	2.30
	> 0.7 to 0.8	1.20	2.10	2.20
	> 0.8 to 0.9	1.20	1.90	2.00
	> 0.9	1.10	1.80	1.90
Operable or Fixed Glazing with Sash	up to 0.4	3.40	3.40	3.40
	> 0.4 to 0.5	2.90	2.90	3.00
	> 0.5 to 0.6	2.60	2.60	2.70
	> 0.6 to 0.7	2.40	2.40	2.40
	> 0.7 to 0.8	2.20	2.20	2.30
	> 0.8 to 0.9	2.00	2.00	2.10
	> 0.9	1.90	1.90	2.00

**Notes to Table A-3.3.1.2.:**

(1) See Appendix Note A-3.3.1.2.(1)

**Table A-5.3.4.3.**  
**Prescriptive Requirements – Heat Recovery**  
 Forming Part of Sentence 5.3.4.3.(1)

Description	Principal Heating Source		
	Electricity, Other	Propane, Oil, Heat Pump	Natural Gas
Heat recovery on principal exhaust component of the mechanical ventilation system in dwelling units	-	-	-

**Region E – 3501 to 4500 Degree-days, West Kootenay Power Service Area**

**Table A-3.2.3.1.**  
**Mandatory Provisions – Building Assemblies in Contact with the Ground**  
 Forming Part of Sentences 3.2.3.1.(1), 3.2.3.2.(1) and 3.2.3.3.(1) and (2)

Assembly Description	Principal Heating Source		
	Electricity, Other	Propane, Oil, Heat Pump	Natural Gas
	Minimum Effective Thermal Resistance (RSI-value), m <sup>2</sup> ·°C/W		
<b>Walls and Roofs:</b>			
Type I - finished	1.70	1.30	0.90
Type II - otherwise unfinished	1.70	1.30	no insulation required
<b>Floors-on-ground:</b>			
Type I - with imbedded heating cables, ducts or pipes (e.g., radiant heating slabs)	1.08 @ full floor area	1.08 @ full floor area	1.08 @ full floor area
Type II - other floors-on-ground less than 0.6 m below grade (e.g., concrete slab with rigid insulation)	1.08 @ perimeter	1.08 @ perimeter	no insulation required

**Table A-3.3.1.1.(1)**  
**Prescriptive Requirements – Above-ground Building Assemblies**  
 Forming Part of Sentence 3.3.1.1.(1)

Assembly Description	Principal Heating Source		
	Electricity, Other	Propane, Oil, Heat Pump	Natural Gas
	Maximum Overall Thermal Transmittance (U-value), W/m <sup>2</sup> ·°C		
<b>Roofs (See Appendix Note A-3.3.1.1.(1)):</b>			
Type I - attic-type roofs	0.140	0.180	0.180
Type II - parallel-chord trusses and joist-type roofs	0.230	0.230	0.230
Type III - all other roofs (e.g., concrete decks with rigid insulation)	0.410	0.470	0.470
<b>Walls</b>	0.450	0.450	0.810
<b>Floors:</b>			
Type I - parallel-chord trusses and joist-type floors	0.220	0.220	0.220
Type II - all other floors (e.g., concrete slabs with rigid insulation)	0.410	0.470	0.470

**Table A-3.3.1.1.(3)**  
**Prescriptive Requirements – Solid Masonry Walls**  
 Forming Part of Sentence 3.3.1.1.(3)

Wall Description	Principal Heating Source		
	Electricity, Other	Propane, Oil, Heat Pump	Natural Gas
Solid masonry walls with no interior or exterior finish that incorporates insulation or creates a space that could accommodate insulation	exempted	exempted	exempted

**Table A-3.3.1.2.**  
**Prescriptive Requirements – Fenestration<sup>(1)</sup>**  
 Forming Part of Sentence 3.3.1.2.(1)

Assembly Description	Fenestration-to-Wall Ratio	Principal Heating Source		
		Electricity, Other	Propane, Oil, Heat Pump	Natural Gas
		Maximum Overall Thermal Transmittance (U-value), W/m <sup>2</sup> .°C		
Fixed Glazing without Sash	up to 0.4	2.10	3.20	3.20
	> 0.4 to 0.5	1.90	2.80	2.80
	> 0.5 to 0.6	1.70	2.50	2.60
	> 0.6 to 0.7	1.60	2.30	2.40
	> 0.7 to 0.8	1.50	2.10	2.20
	> 0.8 to 0.9	1.40	2.00	2.10
	> 0.9	1.40	1.90	2.00
Operable or Fixed Glazing with Sash	up to 0.4	3.40	3.40	3.40
	> 0.4 to 0.5	3.00	3.00	3.00
	> 0.5 to 0.6	2.70	2.60	2.70
	> 0.6 to 0.7	2.40	2.40	2.50
	> 0.7 to 0.8	2.30	2.20	2.30
	> 0.8 to 0.9	2.10	2.10	2.20
	> 0.9	2.00	2.00	2.10

**Notes to Table A-3.3.1.2.:**

(1) See Appendix Note A-3.3.1.2.(1)

**Table A-5.3.4.3.**  
**Prescriptive Requirements – Heat Recovery**  
 Forming Part of Sentence 5.3.4.3.(1)

Description	Principal Heating Source		
	Electricity, Other	Propane, Oil, Heat Pump	Natural Gas
Heat recovery on principal exhaust component of the mechanical ventilation system in dwelling units	-	-	-



# Yukon

## Region A – Southern Yukon

**Table A-3.2.3.1.**  
**Mandatory Provisions – Building Assemblies in Contact with the Ground**  
 Forming Part of Sentences 3.2.3.1.(1), 3.2.3.2.(1) and 3.2.3.3.(1) and (2)

Assembly Description	Principal Heating Source		
	Electricity, Other	Propane, Heat Pump	Oil
	Minimum Effective Thermal Resistance (RSI-value), m <sup>2</sup> ·°C/W		
<b>Walls and Roofs:</b>			
Type I - finished	3.10	3.10	2.40
Type II - otherwise unfinished	3.10	3.10	2.40
<b>Floors-on-ground:</b>			
Type I - with imbedded heating cables, ducts or pipes (e.g., radiant heating slabs)	2.80 @ full floor area	1.50 @ full floor area	1.08 @ full floor area
Type II - other floors-on-ground less than 0.6 m below grade (e.g., concrete slab with rigid insulation)	1.90 @ perimeter	1.08 @ perimeter	1.08 @ perimeter

**Table A-3.3.1.1.(1)**  
**Prescriptive Requirements – Above-ground Building Assemblies**  
 Forming Part of Sentence 3.3.1.1.(1)

Assembly Description	Principal Heating Source		
	Electricity, Other	Propane, Heat Pump	Oil
	Maximum Overall Thermal Transmittance (U-value), W/m <sup>2</sup> ·°C		
<b>Roofs (See Appendix Note A-3.3.1.1.(1)):</b>			
Type I - attic-type roofs	0.100	0.120	0.140
Type II - parallel-chord trusses and joist-type roofs	0.200	0.230	0.230
Type III - all other roofs (e.g., concrete decks with rigid insulation)	0.250	0.290	0.290
<b>Walls</b>	0.270	0.270	0.370
<b>Floors:</b>			
Type I - parallel-chord trusses and joist-type floors	0.200	0.220	0.220
Type II - all other floors (e.g., concrete slabs with rigid insulation)	0.250	0.290	0.290

**Table A-3.3.1.1.(3)**  
**Prescriptive Requirements – Solid Masonry Walls**  
 Forming Part of Sentence 3.3.1.1.(3)

Wall Description	Principal Heating Source		
	Electricity, Other	Propane, Heat Pump	Oil
Solid masonry walls with no interior or exterior finish that incorporates insulation or creates a space that could accommodate insulation	not exempted	not exempted	exempted

**Table A-3.3.1.2.**  
**Prescriptive Requirements – Fenestration<sup>(1)</sup>**  
 Forming Part of Sentence 3.3.1.2.(1)

Assembly Description	Fenestration-to-Wall Ratio	Principal Heating Source		
		Electricity, Other	Propane, Heat Pump	Oil
		Maximum Overall Thermal Transmittance (U-value), W/m <sup>2</sup> .°C		
Fixed Glazing without Sash	up to 0.4	1.20	2.10	2.10
	> 0.4 to 0.5	1.20	1.90	1.90
	> 0.5 to 0.6	1.10	1.70	1.70
	> 0.6 to 0.7	1.10	1.60	1.60
	> 0.7 to 0.8	1.00	1.50	1.50
	> 0.8 to 0.9	1.00	1.40	1.40
	> 0.9	1.00	1.40	1.40
Operable or Fixed Glazing with Sash	up to 0.4	1.90	2.80	2.80
	> 0.4 to 0.5	1.70	2.40	2.40
	> 0.5 to 0.6	1.60	2.20	2.20
	> 0.6 to 0.7	1.50	2.00	2.00
	> 0.7 to 0.8	1.40	1.90	1.90
	> 0.8 to 0.9	1.30	1.80	1.80
	> 0.9	1.30	1.70	1.70

**Notes to Table A-3.3.1.2.:**

(1) See Appendix Note A-3.3.1.2.(1)

**Table A-5.3.4.3.**  
**Prescriptive Requirements – Heat Recovery**  
 Forming Part of Sentence 5.3.4.3.(1)

Description	Principal Heating Source		
	Electricity, Other	Propane, Heat Pump	Oil
Heat recovery on principal exhaust component of the mechanical ventilation system in dwelling units	required	required	required

## Region B – Central Yukon

**Table A-3.2.3.1.**  
**Mandatory Provisions – Building Assemblies in Contact with the Ground**  
 Forming Part of Sentences 3.2.3.1.(1), 3.2.3.2.(1) and 3.2.3.3.(1) and (2)

Assembly Description	Principal Heating Source		
	Electricity, Other	Propane, Heat Pump	Oil
	Minimum Effective Thermal Resistance (RSI-value), m <sup>2</sup> ·°C/W		
<b>Walls and Roofs:</b>			
Type I - finished	3.10	3.10	2.40
Type II - otherwise unfinished	3.10	3.10	2.40
<b>Floors-on-ground:</b>			
Type I - with imbedded heating cables, ducts or pipes (e.g., radiant heating slabs)	2.80 @ full floor area	1.50 @ full floor area	1.08 @ full floor area
Type II - other floors-on-ground less than 0.6 m below grade (e.g., concrete slab with rigid insulation)	2.80 @ full floor area	1.08 @ perimeter	1.08 @ perimeter

**Table A-3.3.1.1.(1)**  
**Prescriptive Requirements – Above-ground Building Assemblies**  
 Forming Part of Sentence 3.3.1.1.(1)

Assembly Description	Principal Heating Source		
	Electricity, Other	Propane, Heat Pump	Oil
	Maximum Overall Thermal Transmittance (U-value), W/m <sup>2</sup> ·°C		
<b>Roofs (See Appendix Note A-3.3.1.1.(1)):</b>			
Type I - attic-type roofs	0.100	0.120	0.140
Type II - parallel-chord trusses and joist-type roofs	0.130	0.200	0.230
Type III - all other roofs (e.g., concrete decks with rigid insulation)	0.180	0.250	0.290
Walls	0.240	0.270	0.330
<b>Floors:</b>			
Type I - parallel-chord trusses and joist-type floors	0.130	0.200	0.220
Type II - all other floors (e.g., concrete slabs with rigid insulation)	0.180	0.250	0.290

**Table A-3.3.1.1.(3)**  
**Prescriptive Requirements – Solid Masonry Walls**  
 Forming Part of Sentence 3.3.1.1.(3)

Wall Description	Principal Heating Source		
	Electricity, Other	Propane, Heat Pump	Oil
Solid masonry walls with no interior or exterior finish that incorporates insulation or creates a space that could accommodate insulation	not exempted	not exempted	not exempted

**Table A-3.3.1.2.**  
**Prescriptive Requirements – Fenestration<sup>(1)</sup>**  
 Forming Part of Sentence 3.3.1.2.(1)

Assembly Description	Fenestration-to-Wall Ratio	Principal Heating Source		
		Electricity, Other	Propane, Heat Pump	Oil
		Maximum Overall Thermal Transmittance (U-value), W/m <sup>2</sup> .°C		
Fixed Glazing without Sash	up to 0.4	1.20	1.80	2.10
	> 0.4 to 0.5	1.20	1.60	1.80
	> 0.5 to 0.6	1.10	1.50	1.60
	> 0.6 to 0.7	1.10	1.40	1.50
	> 0.7 to 0.8	1.00	1.30	1.30
	> 0.8 to 0.9	1.00	1.20	1.30
	> 0.9	1.00	1.10	1.20
Operable or Fixed Glazing with Sash	up to 0.4	1.60	1.90	2.80
	> 0.4 to 0.5	1.50	1.70	2.40
	> 0.5 to 0.6	1.40	1.50	2.10
	> 0.6 to 0.7	1.30	1.40	1.90
	> 0.7 to 0.8	1.20	1.30	1.70
	> 0.8 to 0.9	1.20	1.20	1.60
	> 0.9	1.10	1.20	1.50

**Notes to Table A-3.3.1.2.:**

(1) See Appendix Note A-3.3.1.2.(1)

**Table A-5.3.4.3.**  
**Prescriptive Requirements – Heat Recovery**  
 Forming Part of Sentence 5.3.4.3.(1)

Description	Principal Heating Source		
	Electricity, Other	Propane, Heat Pump	Oil
Heat recovery on principal exhaust component of the mechanical ventilation system in dwelling units	required	required	required

## Region C – Northern Yukon

**Table A-3.2.3.1.**  
**Mandatory Provisions – Building Assemblies in Contact with the Ground**  
 Forming Part of Sentences 3.2.3.1.(1), 3.2.3.2.(1) and 3.2.3.3.(1) and (2)

Assembly Description	Principal Heating Source		
	Electricity, Other	Oil, Propane, Heat Pump	-
	Minimum Effective Thermal Resistance (RSI-value), m <sup>2</sup> ·°C/W		
<b>Walls and Roofs:</b>			
Type I - finished	3.80	3.10	-
Type II - otherwise unfinished	3.80	3.10	-
<b>Floors-on-ground:</b>			
Type I - with imbedded heating cables, ducts or pipes (e.g., radiant heating slabs)	2.80 @ full floor area	1.90 @ full floor area	-
Type II - other floors-on-ground less than 0.6 m below grade (e.g., concrete slab with rigid insulation)	2.80 @ full floor area	1.50 @ perimeter	-

**Table A-3.3.1.1.(1)**  
**Prescriptive Requirements – Above-ground Building Assemblies**  
 Forming Part of Sentence 3.3.1.1.(1)

Assembly Description	Principal Heating Source		
	Electricity, Other	Oil, Propane, Heat Pump	-
	Maximum Overall Thermal Transmittance (U-value), W/m <sup>2</sup> ·°C		
<b>Roofs (See Appendix Note A-3.3.1.1.(1)):</b>			
Type I - attic-type roofs	0.100	0.100	-
Type II - parallel-chord trusses and joist-type roofs	0.130	0.200	-
Type III - all other roofs (e.g., concrete decks with rigid insulation)	0.180	0.250	-
Walls	0.240	0.270	-
<b>Floors:</b>			
Type I - parallel-chord trusses and joist-type floors	0.130	0.200	-
Type II - all other floors (e.g., concrete slabs with rigid insulation)	0.180	0.250	-

**Table A-3.3.1.1.(3)**  
**Prescriptive Requirements – Solid Masonry Walls**  
 Forming Part of Sentence 3.3.1.1.(3)

Wall Description	Principal Heating Source		
	Electricity, Other	Oil, Propane, Heat Pump	-
Solid masonry walls with no interior or exterior finish that incorporates insulation or creates a space that could accommodate insulation	not exempted	not exempted	-

**Table A-3.3.1.2.**  
**Prescriptive Requirements – Fenestration<sup>(1)</sup>**  
 Forming Part of Sentence 3.3.1.2.(1)

Assembly Description	Fenestration-to-Wall Ratio	Principal Heating Source		
		Electricity, Other	Oil, Propane, Heat Pump	-
		Maximum Overall Thermal Transmittance (U-value), W/m <sup>2</sup> .°C		
Fixed Glazing without Sash	up to 0.4	1.20	1.20	-
	> 0.4 to 0.5	1.20	1.10	-
	> 0.5 to 0.6	1.10	1.10	-
	> 0.6 to 0.7	1.10	1.00	-
	> 0.7 to 0.8	1.00	0.90	-
	> 0.8 to 0.9	1.00	0.90	-
	> 0.9	1.00	0.90	-
Operable or Fixed Glazing with Sash	up to 0.4	1.60	1.90	-
	> 0.4 to 0.5	1.50	1.70	-
	> 0.5 to 0.6	1.40	1.50	-
	> 0.6 to 0.7	1.30	1.40	-
	> 0.7 to 0.8	1.20	1.30	-
	> 0.8 to 0.9	1.20	1.20	-
	> 0.9	1.10	1.20	-

**Notes to Table A-3.3.1.2.:**

(1) See Appendix Note A-3.3.1.2.(1)

**Table A-5.3.4.3.**  
**Prescriptive Requirements – Heat Recovery**  
 Forming Part of Sentence 5.3.4.3.(1)

Description	Principal Heating Source		
	Electricity, Other	Oil, Propane, Heat Pump	-
Heat recovery on principal exhaust component of the mechanical ventilation system in dwelling units	required	required	-

# Northwest Territories

## Region A – Southwest Northwest Territories

**Table A-3.2.3.1.**  
**Mandatory Provisions – Building Assemblies in Contact with the Ground**  
 Forming Part of Sentences 3.2.3.1.(1), 3.2.3.2.(1) and 3.2.3.3.(1) and (2)

Assembly Description	Principal Heating Source		
	Electricity, Other	Oil, Propane, Heat Pump	-
	Minimum Effective Thermal Resistance (RSI-value), m <sup>2</sup> ·°C/W		
<b>Walls and Roofs:</b>			
Type I - finished	3.10	2.40	-
Type II - otherwise unfinished	3.10	2.40	-
<b>Floors-on-ground:</b>			
Type I - with imbedded heating cables, ducts or pipes (e.g., radiant heating slabs)	2.80 @ full floor area	1.08 @ full floor area	-
Type II - other floors-on-ground less than 0.6 m below grade (e.g., concrete slab with rigid insulation)	2.80 @ perimeter	1.08 @ perimeter	-

**Table A-3.3.1.1.(1)**  
**Prescriptive Requirements – Above-ground Building Assemblies**  
 Forming Part of Sentence 3.3.1.1.(1)

Assembly Description	Principal Heating Source		
	Electricity, Other	Oil, Propane, Heat Pump	-
	Maximum Overall Thermal Transmittance (U-value), W/m <sup>2</sup> ·°C		
<b>Roofs (See Appendix Note A-3.3.1.1.(1)):</b>			
Type I - attic-type roofs	0.100	0.140	-
Type II - parallel-chord trusses and joist-type roofs	0.130	0.230	-
Type III - all other roofs (e.g., concrete decks with rigid insulation)	0.180	0.290	-
<b>Walls</b>	0.270	0.370	-
<b>Floors:</b>			
Type I - parallel-chord trusses and joist-type floors	0.130	0.220	-
Type II - all other floors (e.g., concrete slabs with rigid insulation)	0.180	0.290	-

**Table A-3.3.1.1.(3)**  
**Prescriptive Requirements – Solid Masonry Walls**  
 Forming Part of Sentence 3.3.1.1.(3)

Wall Description	Principal Heating Source		
	Electricity, Other	Oil, Propane, Heat Pump	-
Solid masonry walls with no interior or exterior finish that incorporates insulation or creates a space that could accommodate insulation	not exempted	exempted	-

**Table A-3.3.1.2.**  
**Prescriptive Requirements – Fenestration<sup>(1)</sup>**  
 Forming Part of Sentence 3.3.1.2.(1)

Assembly Description	Fenestration-to-Wall Ratio	Principal Heating Source		
		Electricity, Other	Oil, Propane, Heat Pump	-
		Maximum Overall Thermal Transmittance (U-value), W/m <sup>2</sup> ·°C		
Fixed Glazing without Sash	up to 0.4	1.20	2.10	-
	> 0.4 to 0.5	1.20	1.80	-
	> 0.5 to 0.6	1.10	1.60	-
	> 0.6 to 0.7	1.10	1.50	-
	> 0.7 to 0.8	1.10	1.40	-
	> 0.8 to 0.9	1.00	1.30	-
	> 0.9	1.00	1.20	-
Operable or Fixed Glazing with Sash	up to 0.4	1.60	2.80	-
	> 0.4 to 0.5	1.50	2.40	-
	> 0.5 to 0.6	1.40	2.10	-
	> 0.6 to 0.7	1.30	1.90	-
	> 0.7 to 0.8	1.30	1.70	-
	> 0.8 to 0.9	1.20	1.60	-
	> 0.9	1.20	1.50	-

**Notes to Table A-3.3.1.2.:**

(1) See Appendix Note A-3.3.1.2.(1)

**Table A-5.3.4.3.**  
**Prescriptive Requirements – Heat Recovery**  
 Forming Part of Sentence 5.3.4.3.(1)

Description	Principal Heating Source		
	Electricity, Other	Oil, Propane, Heat Pump	-
Heat recovery on principal exhaust component of the mechanical ventilation system in dwelling units	required	required	-

**Region B – Great Slave Lake**

**Table A-3.2.3.1.**  
**Mandatory Provisions – Building Assemblies in Contact with the Ground**  
 Forming Part of Sentences 3.2.3.1.(1), 3.2.3.2.(1) and 3.2.3.3.(1) and (2)

Assembly Description	Principal Heating Source		
	Electricity, Other	Propane	Oil, Heat Pump
	Minimum Effective Thermal Resistance (RSI-value), m <sup>2</sup> ·°C/W		
<b>Walls and Roofs:</b>			
Type I - finished	3.10	2.40	2.40
Type II - otherwise unfinished	3.10	2.40	2.40
<b>Floors-on-ground:</b>			
Type I - with imbedded heating cables, ducts or pipes (e.g., radiant heating slabs)	2.80 @ full floor area	1.08 @ full floor area	1.08 @ full floor area
Type II - other floors-on-ground less than 0.6 m below grade (e.g., concrete slab with rigid insulation)	1.90 @ perimeter	1.08 @ perimeter	1.08 @ perimeter

**Table A-3.3.1.1.(1)**  
**Prescriptive Requirements – Above-ground Building Assemblies**  
 Forming Part of Sentence 3.3.1.1.(1)

Assembly Description	Principal Heating Source		
	Electricity, Other	Propane	Oil, Heat Pump
	Maximum Overall Thermal Transmittance (U-value), W/m <sup>2</sup> ·°C		
<b>Roofs (See Appendix Note A-3.3.1.1.(1)):</b>			
Type I - attic-type roofs	0.100	0.120	0.140
Type II - parallel-chord trusses and joist-type roofs	0.130	0.230	0.230
Type III - all other roofs (e.g., concrete decks with rigid insulation)	0.200	0.290	0.290
<b>Walls</b>	0.270	0.330	0.330
<b>Floors:</b>			
Type I - parallel-chord trusses and joist-type floors	0.130	0.220	0.220
Type II - all other floors (e.g., concrete slabs with rigid insulation)	0.200	0.290	0.290

**Table A-3.3.1.1.(3)**  
**Prescriptive Requirements – Solid Masonry Walls**  
 Forming Part of Sentence 3.3.1.1.(3)

Wall Description	Principal Heating Source		
	Electricity, Other	Propane	Oil, Heat Pump
Solid masonry walls with no interior or exterior finish that incorporates insulation or creates a space that could accommodate insulation	not exempted	not exempted	not exempted

**Table A-3.3.1.2.**  
**Prescriptive Requirements – Fenestration<sup>(1)</sup>**  
 Forming Part of Sentence 3.3.1.2.(1)

Assembly Description	Fenestration-to-Wall Ratio	Principal Heating Source		
		Electricity, Other	Propane	Oil, Heat Pump
		Maximum Overall Thermal Transmittance (U-value), W/m <sup>2</sup> ·°C		
Fixed Glazing without Sash	up to 0.4	1.20	2.10	2.10
	> 0.4 to 0.5	1.20	1.80	1.80
	> 0.5 to 0.6	1.10	1.70	1.60
	> 0.6 to 0.7	1.10	1.50	1.50
	> 0.7 to 0.8	1.00	1.40	1.40
	> 0.8 to 0.9	1.00	1.30	1.30
	> 0.9	0.90	1.30	1.20
Operable or Fixed Glazing with Sash	up to 0.4	1.60	2.80	2.80
	> 0.4 to 0.5	1.50	2.40	2.40
	> 0.5 to 0.6	1.40	2.10	2.10
	> 0.6 to 0.7	1.30	2.00	1.90
	> 0.7 to 0.8	1.20	1.80	1.80
	> 0.8 to 0.9	1.20	1.70	1.70
	> 0.9	1.10	1.60	1.60

**Notes to Table A-3.3.1.2.:**

(1) See Appendix Note A-3.3.1.2.(1)

**Table A-5.3.4.3.**  
**Prescriptive Requirements – Heat Recovery**  
 Forming Part of Sentence 5.3.4.3.(1)

Description	Principal Heating Source		
	Electricity, Other	Propane	Oil, Heat Pump
Heat recovery on principal exhaust component of the mechanical ventilation system in dwelling units	required	required	required

**Region C – Mackenzie Valley**

**Table A-3.2.3.1.**  
**Mandatory Provisions – Building Assemblies in Contact with the Ground**  
 Forming Part of Sentences 3.2.3.1.(1), 3.2.3.2.(1) and 3.2.3.3.(1) and (2)

Assembly Description	Principal Heating Source		
	Electricity, Other	Oil, Propane, Heat Pump	Natural Gas
	Minimum Effective Thermal Resistance (RSI-value), m <sup>2</sup> ·°C/W		
<b>Walls and Roofs:</b>			
Type I - finished	3.80	3.10	1.70
Type II - otherwise unfinished	3.80	3.10	no insulation required
<b>Floors-on-ground:</b>			
Type I - with imbedded heating cables, ducts or pipes (e.g., radiant heating slabs)	2.80 @ full floor area	1.50 @ full floor area	1.08 @ full floor area
Type II - other floors-on-ground less than 0.6 m below grade (e.g., concrete slab with rigid insulation)	2.80 @ full floor area	1.08 @ perimeter	1.08 @ perimeter

**Table A-3.3.1.1.(1)**  
**Prescriptive Requirements – Above-ground Building Assemblies**  
 Forming Part of Sentence 3.3.1.1.(1)

Assembly Description	Principal Heating Source		
	Electricity, Other	Oil, Propane, Heat Pump	Natural Gas
	Maximum Overall Thermal Transmittance (U-value), W/m <sup>2</sup> ·°C		
<b>Roofs (See Appendix Note A-3.3.1.1.(1)):</b>			
Type I - attic-type roofs	0.100	0.120	0.200
Type II - parallel-chord trusses and joist-type roofs	0.130	0.200	0.230
Type III - all other roofs (e.g., concrete decks with rigid insulation)	0.180	0.250	0.410
<b>Walls</b>	0.240	0.270	0.480
<b>Floors:</b>			
Type I - parallel-chord trusses and joist-type floors	0.130	0.200	0.220
Type II - all other floors (e.g., concrete slabs with rigid insulation)	0.180	0.250	0.410

**Table A-3.3.1.1.(3)**  
**Prescriptive Requirements – Solid Masonry Walls**  
 Forming Part of Sentence 3.3.1.1.(3)

Wall Description	Principal Heating Source		
	Electricity, Other	Oil, Propane, Heat Pump	Natural Gas
Solid masonry walls with no interior or exterior finish that incorporates insulation or creates a space that could accommodate insulation	not exempted	not exempted	exempted

**Table A-3.3.1.2.**  
**Prescriptive Requirements – Fenestration<sup>(1)</sup>**  
 Forming Part of Sentence 3.3.1.2.(1)

Assembly Description	Fenestration-to-Wall Ratio	Principal Heating Source		
		Electricity, Other	Oil, Propane, Heat Pump	Natural Gas
		Maximum Overall Thermal Transmittance (U-value), W/m <sup>2</sup> .°C		
Fixed Glazing without Sash	up to 0.4	1.20	1.80	3.20
	> 0.4 to 0.5	1.20	1.60	2.70
	> 0.5 to 0.6	1.10	1.40	2.30
	> 0.6 to 0.7	1.10	1.30	2.00
	> 0.7 to 0.8	1.00	1.20	1.80
	> 0.8 to 0.9	1.00	1.10	1.70
	> 0.9	1.00	1.00	1.50
Operable or Fixed Glazing with Sash	up to 0.4	1.60	1.90	3.40
	> 0.4 to 0.5	1.50	1.70	2.80
	> 0.5 to 0.6	1.40	1.50	2.40
	> 0.6 to 0.7	1.30	1.30	2.10
	> 0.7 to 0.8	1.20	1.20	1.90
	> 0.8 to 0.9	1.20	1.10	1.70
	> 0.9	1.10	1.10	1.60

**Notes to Table A-3.3.1.2.:**

(1) See Appendix Note A-3.3.1.2.(1)

**Table A-5.3.4.3.**  
**Prescriptive Requirements – Heat Recovery**  
 Forming Part of Sentence 5.3.4.3.(1)

Description	Principal Heating Source		
	Electricity, Other	Oil, Propane, Heat Pump	Natural Gas
Heat recovery on principal exhaust component of the mechanical ventilation system in dwelling units	required	required	-

**Region D – Western Arctic**

**Table A-3.2.3.1.**  
**Mandatory Provisions – Building Assemblies in Contact with the Ground**  
 Forming Part of Sentences 3.2.3.1.(1), 3.2.3.2.(1) and 3.2.3.3.(1) and (2)

Assembly Description	Principal Heating Source		
	Electricity, Other	Oil, Propane, Heat Pump	-
	Minimum Effective Thermal Resistance (RSI-value), m <sup>2</sup> ·°C/W		
<b>Walls and Roofs:</b>			
Type I - finished	3.80	3.10	-
Type II - otherwise unfinished	3.80	3.10	-
<b>Floors-on-ground:</b>			
Type I - with imbedded heating cables, ducts or pipes (e.g., radiant heating slabs)	2.80 @ full floor area	1.50 @ full floor area	-
Type II - other floors-on-ground less than 0.6 m below grade (e.g., concrete slab with rigid insulation)	2.80 @ full floor area	1.08 @ perimeter	-

**Table A-3.3.1.1.(1)**  
**Prescriptive Requirements – Above-ground Building**  
 Forming Part of Sentence 3.3.1.1.(1)

Assembly Description	Principal Heating Source		
	Electricity, Other	Oil, Propane, Heat Pump	-
	Maximum Overall Thermal Transmittance (U-value), W/m <sup>2</sup> ·°C		
<b>Roofs (See Appendix Note A-3.3.1.1.(1)):</b>			
Type I - attic-type roofs	0.100	0.120	-
Type II - parallel-chord trusses and joist-type roofs	0.130	0.200	-
Type III - all other roofs (e.g., concrete decks with rigid insulation)	0.180	0.270	-
<b>Walls</b>	0.240	0.270	-
<b>Floors:</b>			
Type I - parallel-chord trusses and joist-type floors	0.130	0.200	-
Type II - all other floors (e.g., concrete slabs with rigid insulation)	0.180	0.270	-

**Table A-3.3.1.1.(3)**  
**Prescriptive Requirements – Solid Masonry Walls**  
 Forming Part of Sentence 3.3.1.1.(3)

Wall Description	Principal Heating Source		
	Electricity, Other	Oil, Propane, Heat Pump	-
Solid masonry walls with no interior or exterior finish that incorporates insulation or creates a space that could accommodate insulation	not exempted	not exempted	-

**Table A-3.3.1.2.**  
**Prescriptive Requirements – Fenestration<sup>(1)</sup>**  
 Forming Part of Sentence 3.3.1.2.(1)

Assembly Description	Fenestration-to-Wall Ratio	Principal Heating Source		
		Electricity, Other	Oil, Propane, Heat Pump	-
		Maximum Overall Thermal Transmittance (U-value), W/m <sup>2</sup> .°C		
Fixed Glazing without Sash	up to 0.4	1.20	2.10	-
	> 0.4 to 0.5	1.20	1.80	-
	> 0.5 to 0.6	1.10	1.60	-
	> 0.6 to 0.7	1.10	1.50	-
	> 0.7 to 0.8	1.00	1.30	-
	> 0.8 to 0.9	1.00	1.30	-
	> 0.9	1.00	1.20	-
Operable or Fixed Glazing with Sash	up to 0.4	1.60	2.30	-
	> 0.4 to 0.5	1.50	1.90	-
	> 0.5 to 0.6	1.40	1.70	-
	> 0.6 to 0.7	1.30	1.60	-
	> 0.7 to 0.8	1.20	1.40	-
	> 0.8 to 0.9	1.20	1.30	-
	> 0.9	1.10	1.30	-

**Notes to Table A-3.3.1.2.:**

(1) See Appendix Note A-3.3.1.2.(1)

**Table A-5.3.4.3.**  
**Prescriptive Requirements – Heat Recovery**  
 Forming Part of Sentence 5.3.4.3.(1)

Description	Principal Heating Source		
	Electricity, Other	Oil, Propane, Heat Pump	-
Heat recovery on principal exhaust component of the mechanical ventilation system in dwelling units	required	required	-

**Region E – Keewatin**

**Table A-3.2.3.1.**  
**Mandatory Provisions – Building Assemblies in Contact with the Ground**  
 Forming Part of Sentences 3.2.3.1.(1), 3.2.3.2.(1) and 3.2.3.3.(1) and (2)

Assembly Description	Principal Heating Source		
	Electricity, Other	Oil, Propane, Heat Pump	-
	Minimum Effective Thermal Resistance (RSI-value), m <sup>2</sup> ·°C/W		
<b>Walls and Roofs:</b>			
Type I - finished	3.80	3.10	-
Type II - otherwise unfinished	3.80	3.10	-
<b>Floors-on-ground:</b>			
Type I - with imbedded heating cables, ducts or pipes (e.g., radiant heating slabs)	2.80 @ full floor area	1.50 @ full floor area	-
Type II - other floors-on-ground less than 0.6 m below grade (e.g., concrete slab with rigid insulation)	2.80 @ full floor area	1.50 @ perimeter	-

**Table A-3.3.1.1.(1)**  
**Prescriptive Requirements – Above-ground Building Assemblies**  
 Forming Part of Sentence 3.3.1.1.(1)

Assembly Description	Principal Heating Source		
	Electricity, Other	Oil, Propane, Heat Pump	-
	Maximum Overall Thermal Transmittance (U-value), W/m <sup>2</sup> ·°C		
<b>Roofs (See Appendix Note A-3.3.1.1.(1)):</b>			
Type I - attic-type roofs	0.100	0.120	-
Type II - parallel-chord trusses and joist-type roofs	0.130	0.200	-
Type III - all other roofs (e.g., concrete decks with rigid insulation)	0.180	0.250	-
<b>Walls</b>	0.240	0.270	-
<b>Floors:</b>			
Type I - parallel-chord trusses and joist-type floors	0.130	0.200	-
Type II - all other floors (e.g., concrete slabs with rigid insulation)	0.180	0.250	-

**Table A-3.3.1.1.(3)**  
**Prescriptive Requirements – Solid Masonry Walls**  
 Forming Part of Sentence 3.3.1.1.(3)

Wall Description	Principal Heating Source		
	Electricity, Other	Oil, Propane, Heat Pump	-
Solid masonry walls with no interior or exterior finish that incorporates insulation or creates a space that could accommodate insulation	not exempted	not exempted	-

**Table A-3.3.1.2.**  
**Prescriptive Requirements – Fenestration<sup>(1)</sup>**  
 Forming Part of Sentence 3.3.1.2.(1)

Assembly Description	Fenestration-to-Wall Ratio	Principal Heating Source		
		Electricity, Other	Oil, Propane, Heat Pump	-
		Maximum Overall Thermal Transmittance (U-value), W/m <sup>2</sup> .°C		
Fixed Glazing without Sash	up to 0.4	1.20	1.80	-
	> 0.4 to 0.5	1.20	1.60	-
	> 0.5 to 0.6	1.10	1.50	-
	> 0.6 to 0.7	1.10	1.40	-
	> 0.7 to 0.8	1.10	1.30	-
	> 0.8 to 0.9	1.00	1.20	-
	> 0.9	1.00	1.20	-
Operable or Fixed Glazing with Sash	up to 0.4	1.60	2.30	-
	> 0.4 to 0.5	1.50	2.00	-
	> 0.5 to 0.6	1.40	1.80	-
	> 0.6 to 0.7	1.30	1.60	-
	> 0.7 to 0.8	1.30	1.50	-
	> 0.8 to 0.9	1.20	1.40	-
	> 0.9	1.20	1.40	-

**Notes to Table A-3.3.1.2.:**

(1) See Appendix Note A-3.3.1.2.(1)

**Table A-5.3.4.3.**  
**Prescriptive Requirements – Heat Recovery**  
 Forming Part of Sentence 5.3.4.3.(1)

Description	Principal Heating Source		
	Electricity, Other	Oil, Propane, Heat Pump	-
Heat recovery on principal exhaust component of the mechanical ventilation system in dwelling units	required	required	-

**Region F – Baffin**

**Table A-3.2.3.1.**  
**Mandatory Provisions – Building Assemblies in Contact with the Ground**  
 Forming Part of Sentences 3.2.3.1.(1), 3.2.3.2.(1) and 3.2.3.3.(1) and (2)

Assembly Description	Principal Heating Source		
	Electricity, Other	Oil, Propane, Heat Pump	-
	Minimum Effective Thermal Resistance (RSI-value), m <sup>2</sup> ·°C/W		
<b>Walls and Roofs:</b>			
Type I - finished	3.80	2.70	-
Type II - otherwise unfinished	3.80	2.70	-
<b>Floors-on-ground:</b>			
Type I - with imbedded heating cables, ducts or pipes (e.g., radiant heating slabs)	2.80 @ full floor area	1.08 @ full floor area	-
Type II - other floors-on-ground less than 0.6 m below grade (e.g., concrete slab with rigid insulation)	2.80 @ full floor area	1.08 @ perimeter	-

**Table A-3.3.1.1.(1)**  
**Prescriptive Requirements – Above-ground Building Assemblies**  
 Forming Part of Sentence 3.3.1.1.(1)

Assembly Description	Principal Heating Source		
	Electricity, Other	Oil, Propane, Heat Pump	-
	Maximum Overall Thermal Transmittance (U-value), W/m <sup>2</sup> ·°C		
<b>Roofs (See Appendix Note A-3.3.1.1.(1)):</b>			
Type I - attic-type roofs	0.100	0.120	-
Type II - parallel-chord trusses and joist-type roofs	0.130	0.230	-
Type III - all other roofs (e.g., concrete decks with rigid insulation)	0.180	0.290	-
<b>Walls</b>	0.240	0.300	-
<b>Floors:</b>			
Type I - parallel-chord trusses and joist-type floors	0.130	0.220	-
Type II - all other floors (e.g., concrete slabs with rigid insulation)	0.180	0.290	-

**Table A-3.3.1.1.(3)**  
**Prescriptive Requirements – Solid Masonry Walls**  
 Forming Part of Sentence 3.3.1.1.(3)

Wall Description	Principal Heating Source		
	Electricity, Other	Oil, Propane, Heat Pump	-
Solid masonry walls with no interior or exterior finish that incorporates insulation or creates a space that could accommodate insulation	not exempted	not exempted	-

**Table A-3.3.1.2.**  
**Prescriptive Requirements – Fenestration<sup>(1)</sup>**  
 Forming Part of Sentence 3.3.1.2.(1)

Assembly Description	Fenestration-to-Wall Ratio	Principal Heating Source		
		Electricity, Other	Oil, Propane, Heat Pump	-
		Maximum Overall Thermal Transmittance (U-value), W/m <sup>2</sup> .°C		
Fixed Glazing without Sash	up to 0.4	1.20	2.10	-
	> 0.4 to 0.5	1.20	1.80	-
	> 0.5 to 0.6	1.10	1.70	-
	> 0.6 to 0.7	1.10	1.60	-
	> 0.7 to 0.8	1.10	1.50	-
	> 0.8 to 0.9	1.10	1.40	-
	> 0.9	1.00	1.40	-
Operable or Fixed Glazing with Sash	up to 0.4	1.60	2.80	-
	> 0.4 to 0.5	1.50	2.40	-
	> 0.5 to 0.6	1.40	2.20	-
	> 0.6 to 0.7	1.30	2.00	-
	> 0.7 to 0.8	1.30	1.90	-
	> 0.8 to 0.9	1.20	1.80	-
	> 0.9	1.20	1.70	-

**Notes to Table A-3.3.1.2.:**

(1) See Appendix Note A-3.3.1.2.(1)

**Table A-5.3.4.3.**  
**Prescriptive Requirements – Heat Recovery**  
 Forming Part of Sentence 5.3.4.3.(1)

Description	Principal Heating Source		
	Electricity, Other	Oil, Propane, Heat Pump	-
Heat recovery on principal exhaust component of the mechanical ventilation system in dwelling units	required	required	-

**Region G – Eastern Arctic**

**Table A-3.2.3.1.**  
**Mandatory Provisions – Building Assemblies in Contact with the Ground**  
 Forming Part of Sentences 3.2.3.1.(1), 3.2.3.2.(1) and 3.2.3.3.(1) and (2)

Assembly Description	Principal Heating Source		
	Electricity, Other	Oil, Propane, Heat Pump	-
	Minimum Effective Thermal Resistance (RSI-value), m <sup>2</sup> ·°C/W		
<b>Walls and Roofs:</b>			
Type I - finished	3.80	2.40	-
Type II - otherwise unfinished	3.80	2.40	-
<b>Floors-on-ground:</b>			
Type I - with imbedded heating cables, ducts or pipes (e.g., radiant heating slabs)	2.80 @ full floor area	1.08 @ full floor area	-
Type II - other floors-on-ground less than 0.6 m below grade (e.g., concrete slab with rigid insulation)	2.80 @ full floor area	1.08 @ perimeter	-

**Table A-3.3.1.1.(1)**  
**Prescriptive Requirements – Above-ground Building Assemblies**  
 Forming Part of Sentence 3.3.1.1.(1)

Assembly Description	Principal Heating Source		
	Electricity, Other	Oil, Propane, Heat Pump	-
	Maximum Overall Thermal Transmittance (U-value), W/m <sup>2</sup> ·°C		
<b>Roofs (See Appendix Note A-3.3.1.1.(1)):</b>			
Type I - attic-type roofs	0.100	0.140	-
Type II - parallel-chord trusses and joist-type roofs	0.130	0.230	-
Type III - all other roofs (e.g., concrete decks with rigid insulation)	0.180	0.290	-
<b>Walls</b>	0.240	0.330	-
<b>Floors:</b>			
Type I - parallel-chord trusses and joist-type floors	0.130	0.220	-
Type II - all other floors (e.g., concrete slabs with rigid insulation)	0.180	0.290	-

**Table A-3.3.1.1.(3)**  
**Prescriptive Requirements – Solid Masonry Walls**  
 Forming Part of Sentence 3.3.1.1.(3)

Wall Description	Principal Heating Source		
	Electricity, Other	Oil, Propane, Heat Pump	-
Solid masonry walls with no interior or exterior finish that incorporates insulation or creates a space that could accommodate insulation	not exempted	not exempted	-

**Table A-3.3.1.2.**  
**Prescriptive Requirements – Fenestration<sup>(1)</sup>**  
 Forming Part of Sentence 3.3.1.2.(1)

Assembly Description	Fenestration-to-Wall Ratio	Principal Heating Source		
		Electricity, Other	Oil, Propane, Heat Pump	-
		Maximum Overall Thermal Transmittance (U-value), W/m <sup>2</sup> ·°C		
Fixed Glazing without Sash	up to 0.4	1.20	2.10	-
	> 0.4 to 0.5	1.20	1.80	-
	> 0.5 to 0.6	1.10	1.70	-
	> 0.6 to 0.7	1.10	1.60	-
	> 0.7 to 0.8	1.10	1.50	-
	> 0.8 to 0.9	1.10	1.40	-
	> 0.9	1.00	1.40	-
Operable or Fixed Glazing with Sash	up to 0.4	1.60	2.80	-
	> 0.4 to 0.5	1.50	2.40	-
	> 0.5 to 0.6	1.40	2.20	-
	> 0.6 to 0.7	1.30	2.00	-
	> 0.7 to 0.8	1.30	1.90	-
	> 0.8 to 0.9	1.20	1.70	-
	> 0.9	1.20	1.70	-

**Notes to Table A-3.3.1.2.:**

(1) See Appendix Note A-3.3.1.2.(1)

**Table A-5.3.4.3.**  
**Prescriptive Requirements – Heat Recovery**  
 Forming Part of Sentence 5.3.4.3.(1)

Description	Principal Heating Source		
	Electricity, Other	Oil, Propane, Heat Pump	-
Heat recovery on principal exhaust component of the mechanical ventilation system in dwelling units	required	required	-

**Region H – Arctic Islands**

**Table A-3.2.3.1.**  
**Mandatory Provisions – Building Assemblies in Contact with the Ground**  
 Forming Part of Sentences 3.2.3.1.(1), 3.2.3.2.(1) and 3.2.3.3.(1) and (2)

Assembly Description	Principal Heating Source		
	Electricity, Other	Oil, Propane, Heat Pump	-
	Minimum Effective Thermal Resistance (RSI-value), m <sup>2</sup> ·°C/W		
<b>Walls and Roofs:</b>			
Type I - finished	3.80	2.70	-
Type II - otherwise unfinished	3.80	2.70	-
<b>Floors-on-ground:</b>			
Type I - with imbedded heating cables, ducts or pipes (e.g., radiant heating slabs)	2.80 @ full floor area	1.08 @ full floor area	-
Type II - other floors-on-ground less than 0.6 m below grade (e.g., concrete slab with rigid insulation)	2.80 @ full floor area	1.08 @ perimeter	-

**Table A-3.3.1.1.(1)**  
**Prescriptive Requirements – Above-ground Building Assemblies**  
 Forming Part of Sentence 3.3.1.1.(1)

Assembly Description	Principal Heating Source		
	Electricity, Other	Oil, Propane, Heat Pump	-
	Maximum Overall Thermal Transmittance (U-value), W/m <sup>2</sup> ·°C		
<b>Roofs (See Appendix Note A-3.3.1.1.(1)):</b>			
Type I - attic-type roofs	0.100	0.140	-
Type II - parallel-chord trusses and joist-type roofs	0.130	0.230	-
Type III - all other roofs (e.g., concrete decks with rigid insulation)	0.180	0.290	-
<b>Walls</b>	0.240	0.330	-
<b>Floors:</b>			
Type I - parallel-chord trusses and joist-type floors	0.130	0.220	-
Type II - all other floors (e.g., concrete slabs with rigid insulation)	0.180	0.290	-

**Table A-3.3.1.1.(3)**  
**Prescriptive Requirements – Solid Masonry Walls**  
 Forming Part of Sentence 3.3.1.1.(3)

Wall Description	Principal Heating Source		
	Electricity, Other	Oil, Propane, Heat Pump	-
Solid masonry walls with no interior or exterior finish that incorporates insulation or creates a space that could accommodate insulation	not exempted	not exempted	-

**Table A-3.3.1.2.**  
**Prescriptive Requirements – Fenestration<sup>(1)</sup>**  
 Forming Part of Sentence 3.3.1.2.(1)

Assembly Description	Fenestration-to-Wall Ratio	Principal Heating Source		
		Electricity, Other	Oil, Propane, Heat Pump	-
		Maximum Overall Thermal Transmittance (U-value), W/m <sup>2</sup> .°C		
Fixed Glazing without Sash	up to 0.4	1.20	2.10	-
	> 0.4 to 0.5	1.20	1.80	-
	> 0.5 to 0.6	1.10	1.70	-
	> 0.6 to 0.7	1.10	1.60	-
	> 0.7 to 0.8	1.00	1.50	-
	> 0.8 to 0.9	1.00	1.40	-
	> 0.9	1.00	1.40	-
Operable or Fixed Glazing with Sash	up to 0.4	1.60	2.80	-
	> 0.4 to 0.5	1.50	2.40	-
	> 0.5 to 0.6	1.40	2.20	-
	> 0.6 to 0.7	1.30	2.00	-
	> 0.7 to 0.8	1.20	1.90	-
	> 0.8 to 0.9	1.20	1.80	-
	> 0.9	1.10	1.70	-

**Notes to Table A-3.3.1.2.:**

(1) See Appendix Note A-3.3.1.2.(1)

**Table A-5.3.4.3.**  
**Prescriptive Requirements – Heat Recovery**  
 Forming Part of Sentence 5.3.4.3.(1)

Description	Principal Heating Source		
	Electricity, Other	Oil, Propane, Heat Pump	-
Heat recovery on principal exhaust component of the mechanical ventilation system in dwelling units	required	required	-

---

# Appendix B

## Thermal Characteristics of Common Building Assemblies

### Abbreviations and Symbols

Effective RSI	• effective thermal resistance of the overall assembly, including insulation, sheathing and finishing materials, air films and thermal bridging of framing members
Overall U-value	• overall thermal transmittance (for opaque components, this includes air films and thermal bridging of framing members)
EPS board Type I	• expanded polystyrene (bead board) type 1
EPS board Type II	• expanded polystyrene (bead board) type 2
EPS board Type III	• expanded polystyrene (bead board) type 3
XPS board Type II	• extruded polystyrene type 2
XPS board Type III	• extruded polystyrene type 3
XPS board Type IV	• extruded polystyrene type 4
PIR	• polyisocyanurate insulation board
PUR	• polyurethane insulation board
RSI Adjustment	• additional thermal resistance to be added to the effective thermal resistance of the overall assembly if the materials differ from what is specified in the main table section or if additional materials are specified

### Examples

The following examples demonstrate how to use Appendix B. In Example 1, the building assembly is specified and its effective RSI is found. In Example 2, an effective RSI (or overall U-value) is given and possible sheathing and cavity insulation materials that meet the RSI requirement are determined.

Example 1. Determine the effective RSI and overall U-value for the specified steel stud wall assembly.

Given: The wall assembly consists of 41 x 152 mm steel studs at 610 mm on centre (o.c.) with mineral fibre batt cavity insulation, 38 mm EPS board Type II sheathing, 16 mm gypsum board interior finish and 100 mm brick exterior finish.

Step 1 Determine the RSI values for the sheathing and insulation.

Table B-1, Thickness of Insulation Materials, lists the RSI values for insulating sheathing and insulation. Using the "Insulating Sheathing" section, follow across the table to EPS board Type II and down the table to 38 mm. In the leftmost column is the RSI value for the sheathing type and thickness:

$$RSI_{\text{EPS board Type II}} = 1.05$$

Similarly, find the cavity insulation RSI using the "Stud Cavity/Floor Joist Cavity/Truss-Type-Roof Cavity Insulation" section. Follow across the table to glass/mineral fibre batts and down the table to "140 and 152":

$$RSI_{\text{mineral fibre batts}} = 3.52$$

## Appendix B

- Step 2 Determine the effective RSI (or overall U-value) of the building assembly, using the appropriate table in Tables B-2 to B-25.

Table B-9, Metal Frame Wall: 41 x 152 mm @ 610 mm o.c., provides effective RSI and overall U-values for common insulating sheathing and cavity insulation RSI values applied to the specified framing. Using the RSI values from Step 1, move across the table under "Cavity Insulation" to RSI 3.52 and down the table to RSI 1.05 sheathing under "Sheathing":

$$\begin{aligned}\text{effective RSI (RSI}_{T1}) &= 3.42 \\ \text{overall U-value (U}_{T1}) &= 0.293\end{aligned}$$

However, as noted below the table title, these numbers have been generated using aluminum or vinyl siding as the exterior finish and 13 mm gypsum board as the interior finish. The "RSI Adjustment" sections of Table B-9 must be used to adjust the values for the 100 mm brick and 16 mm gypsum board specified for this example.

- Step 3 Adjusting the effective RSI and overall U-value for exterior and interior finishes.

To determine the adjustment for the 100 mm brick exterior finish, locate "100 mm brick and 25 mm air" under the "Exterior Finish" RSI adjustment section of the table:

$$\text{RSI adjustment}_{\text{exterior, 100 mm brick}} = 0.14$$

Similarly, find the adjustment for the 16 mm gypsum board interior finish:

$$\text{RSI adjustment}_{\text{interior, 16 mm gypsum board}} = 0.02$$

For the total effective RSI value, add these adjustments to  $\text{RSI}_{T1}$ :

$$\begin{aligned}\text{RSI}_T &= 3.42 + 0.14 + 0.02 \\ &= 3.58\end{aligned}$$

Use  $\text{RSI}_T$  to determine the new overall U-value:

$$\begin{aligned}U_T &= 1 \div \text{RSI}_T \\ &= 1 \div 3.58 \\ &= 0.279\end{aligned}$$

- Example 2. For a truss-type floor, determine possible floor assembly materials, given the required effective RSI (overall U-value).

Given: A truss-type floor assembly at 610 mm o.c. must have a minimum effective RSI of 8.33 (maximum overall U-value of 0.120).

- Step 1 Locate the appropriate table for truss-type floors in Tables B-2 to B-25.

Table B-19, Floor: Truss- or Wood I-Joist-Type @ 610 mm o.c., lists the effective RSI (overall U-value) for truss- or wood I-joist-type floors with no exterior finish and carpet and fibrous pad interior finish.

- Step 2 Find the sheathing and cavity insulation RSI values that provide the required minimum effective RSI (maximum overall U-value).

From Table B-19, the closest effective RSI (overall U-value) equal to or greater than 8.33 (0.120) is 8.35 (0.120). This value corresponds to a cavity insulation RSI of 7.04 and a sheathing RSI of 0.88 when used with carpet and fibrous pad interior finish and no exterior finish.

- Step 3 Determine possible material types for the indicated sheathing and cavity insulation RSI values.

Table B-1, Thickness of Insulation Materials, lists the RSI values for insulating sheathing and insulation. In the "Insulating Sheathing" section, move down the RSI column to 0.88. This row shows the thickness of the various sheathing materials that will meet this RSI value. Two possibilities are 30 mm EPS board Type III or 54 mm insulating fibreboard sheathing.

From the "Attic-type Roof/Truss-type Floor" section of Table B-1, the cavity insulating material can be determined by moving down the RSI column to 7.04. Two possible cavity insulators are 265 mm glass or mineral fibre batts and 352 mm loose fill mineral fibre.

**Table B-1**  
**Thickness of Insulation Materials**  
 for RSI Values Shown in Tables B-2 to B-25

RSI	Material Thickness, mm						
	Insulating Sheathing						
	EPS board Type I	EPS board Type II	EPS board Type III	XPS board Type II, III, IV	semi-rigid glass fibre	insulated fibreboard sheathing	faced PIR/ PUR
0.68	26	24	23	19	23	41	14
0.79	30	28	27	23	26	48	16
0.88	34	31	30	25	29	54	18
0.97	37	35	33	28	32	59	19
1.05	40	38	35	30	35	64	21
1.14	44	41	39	33	38	70	23
1.32	51	47	45	38	44	80	26
1.42	55	51	48	41	47	87	28
1.76	68	63	59	50	59	107	35
2.13	82	76	72	61	71	130	43
2.84	109	101	96	81	95	173	57
	Attic-Type Roof/Truss-Type Floor Insulation						
	glass/mineral fibre batts <sup>(1)</sup>	loose fill cellulose	loose fill mineral fibre				
5.46	222	218	273				
5.64	-	226	282				
6.00	-	240	300				
6.16	251	246	308				
7.04	265	282	352				
8.81	152 + 222	352	441				
10.6	265 + 152	424	530				
	Joist-Type Roof Insulation						
	glass/mineral fibre batts <sup>(1)</sup>	EPS board Type I	unfaced PIR/ PUR board	sprayed cellulose fibre	sprayed glass fibre	sprayed polyurethane foam	
3.52	152	135	84	147	135	84	
4.93	202	190	117	205	190	117	
5.46	222	210	130	228	210	130	
6.00	-	231	143	250	231	143	
6.16	251	237	147	257	237	147	
7.04	265	271	168	293	271	168	

## Appendix B

Table B-1 (Continued)

RSI	Material Thickness, mm					
	Built-Up Roof Insulation					
	rigid glass fibre roof insulation	EPS board Type I	EPS board Type II	EPS board Type III	XPS board Type II, III, IV	faced PIR/PUR board
0.68	25	26	24	23	20	16
0.97	38	37	35	33	28	19
1.41	57	54	50	48	41	28
1.85	75	71	66	63	53	37
2.20	89	85	79	74	63	44
2.64	109	102	94	89	76	53
	Stud Cavity/Floor Joist Cavity/Truss-Type-Roof Cavity Insulation					
	glass/mineral fibre batts <sup>(1)</sup>	EPS board Type I	sprayed cellulose fibre	sprayed glass fibre	sprayed polyurethane foam	
1.41	65	54	59	54	34	
2.11	89	81	88	81	50	
2.29	89	88	95	88	55	
2.46	89	95	103	95	59	
3.25	140	125	135	125	77	
3.34	140 <sup>(2)</sup>	128	139	128	80	
3.52	140 and 152	135	147	135	84	
3.70	-	142	154	142	88	
3.87	140	149	161	149	92	
4.93	202	190	205	190	117	
5.46	222	210	228	210	130	
5.90	-	227	246	227	140	
6.16	251	237	257	237	147	
6.40	-	246	267	246	152	
7.04	265	271	293	271	168	
	Double Wall Insulation					
	glass/mineral fibre batts <sup>(1)</sup>	loose fill cellulose fibre	sprayed cellulose fibre	sprayed glass fibre	sprayed polyurethane foam	
4.58	89 + 89	183	191	176	109	
5.63	89 + 140 or 89 + 152	225	235	217	134	
7.04	89 + 202	282	293	271	168	
7.39	89 + 202	296	308	284	176	

**Table B-1 (Continued)**

RSI	Material Thickness, mm		
	Concrete Floor Insulation		
	EPS board Type II	EPS board Type III	XPS board Type IV
0.88	31	30	25
1.32	47	45	38
1.76	63	59	51
2.64	94	89	76
3.52	126	119	101
4.42	158	149	127

**Notes to Table B-1:**

- (1) Batt thickness may vary for a given thermal resistance, depending on the manufacturer.
- (2) 152 mm medium-density batt, compressed to 140 mm.

## Appendix B

**Table B-2**  
**Roof: Attic-Type**  
with 13 mm gypsum board interior finish

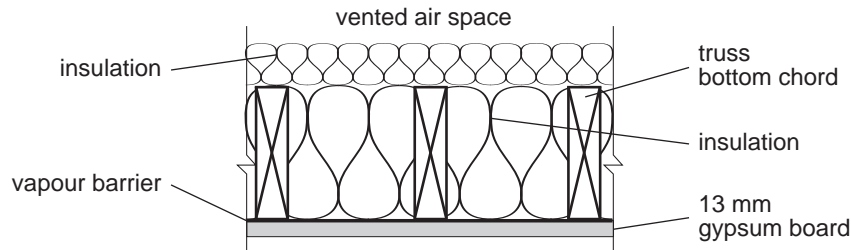

Framing/Spacing	Cavity Insulation <sup>(1)(2)</sup>				
	RSI 5.64	RSI 6.00	RSI 7.04	RSI 8.81	RSI 10.6
	Effective RSI (Overall U-Value) <sup>(3)(4)</sup>				
38 x 89 mm @ 406 mm o.c.	5.66 (0.177)	6.03 (0.166)	7.07 (0.141)	8.85 (0.113)	10.65 (0.094)
38 x 89 mm @ 610 mm o.c.	5.72 (0.175)	6.08 (0.164)	7.13 (0.140)	8.90 (0.112)	10.70 (0.093)
38 x 114 mm @ 406 mm o.c.	5.59 (0.179)	5.95 (0.168)	7.01 (0.143)	8.79 (0.114)	10.59 (0.094)
38 x 114 mm @ 610 mm o.c.	5.67 (0.176)	6.03 (0.166)	7.08 (0.141)	8.86 (0.113)	10.66 (0.094)
38 x 140 mm @ 406 mm o.c.	5.49 (0.182)	5.86 (0.171)	6.93 (0.144)	8.72 (0.115)	10.52 (0.095)
38 x 140 mm @ 610 mm o.c.	5.60 (0.179)	5.96 (0.168)	7.02 (0.142)	8.81 (0.114)	10.61 (0.094)
	Interior Finish				
	13 mm plywood	hung ceiling	strapping		
RSI Adjustment	0.03	0.18	0.15		
<p>Example: 38 x 89 mm @ 406 mm o.c. with RSI 5.64 cavity insulation</p> $RSI_F = \text{Exterior Air} + 89 \text{ mm Wood Framing} + \text{Insulation Above Framing} + 13 \text{ mm Gypsum} + \text{Interior Air}$ $= 0.03 + 0.7209 + (5.64 - (89 \times (5.64 \div 226))) + 0.0793 + 0.11$ $= 4.359$ $RSI_I = \text{Exterior Air} + \text{Insulation} + 13 \text{ mm Gypsum} + \text{Interior Air}$ $= 0.03 + 5.64 + 0.0793 + 0.11$ $= 5.8593$ $RSI_T = 1 \div ((0.1 \div RSI_F) + (0.9 \div RSI_I))$ $= 5.66$					

### Notes to Table B-2:

- (1) To convert insulation RSI to insulation thickness, see Table B-1.
- (2) Loose fill cellulose used to determine insulation thickness.
- (3) The effective thermal resistance and overall thermal transmittance values given have been calculated using framing percentages listed in Table C-1 of Appendix C.
- (4) No credit for materials to the exterior of vented air space.

**Table B-3**  
**Roof: Roof-Joist-Type**  
 with 13 mm gypsum board interior finish

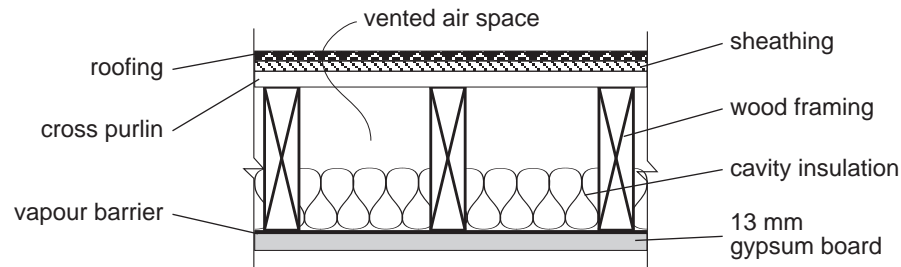

Joist Spacing	Cavity Insulation <sup>(1)(2)</sup>				
	RSI 3.52	RSI 4.93	RSI 5.46	RSI 6.16	RSI 7.04
	Effective RSI (Overall U-Value) <sup>(3)(4)</sup>				
wood @ 406 mm o.c.	3.23 (0.310)	4.37 (0.229)	4.81 (0.208)	5.39 (0.185)	6.02 (0.166)
wood @ 610 mm o.c.	3.37 (0.297)	4.58 (0.218)	5.04 (0.198)	5.65 (0.177)	6.34 (0.158)
RSI Adjustment	Interior Finish				
	13 mm plywood	hung ceiling	strapping		
	0.03	0.18	0.15		
<p>Example: wood @ 406 mm o.c. with RSI 3.52 cavity insulation</p> $RSI_F = \text{Exterior Air} + \text{Wood Framing (to top of insulation)} + 13 \text{ mm Gypsum} + \text{Interior Air}$ $= 0.03 + (0.0081 \times 152) + 0.0793 + 0.11$ $= 1.4505$ $RSI_I = \text{Exterior Air} + \text{Insulation} + 13 \text{ mm Gypsum} + \text{Interior Air}$ $= 0.03 + 3.52 + 0.0793 + 0.11$ $= 3.7393$ $RSI_T = 1 \div ((0.1 \div RSI_F) + (0.9 \div RSI_I))$ $= 3.23$					

**Notes to Table B-3:**

- (1) To convert insulation RSI to insulation thickness, see Table B-1.
- (2) Glass/mineral fibre batts used to determine insulation thickness.
- (3) The effective thermal resistance and overall thermal transmittance values given have been calculated using framing percentages listed in Table C-1 of Appendix C.
- (4) No credit for materials to the exterior of vented air space.

## Appendix B

**Table B-4**  
**Roof: Built-Up**  
with asphalt built-up roofing and no interior finish

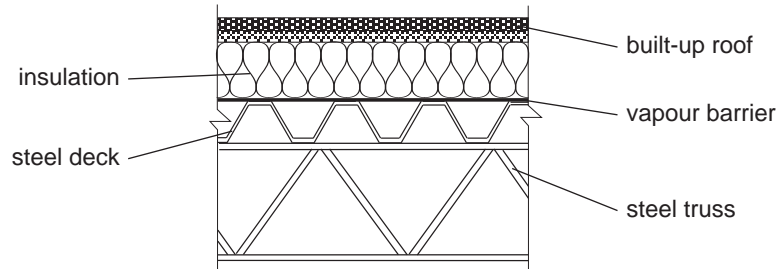

Deck	Insulation <sup>(1)</sup>					
	RSI 0.68	RSI 0.97	RSI 1.41	RSI 1.85	RSI 2.20	RSI 2.64
	Effective RSI (Overall U-Value) <sup>(2)</sup>					
metal deck	0.88 (1.135)	1.17 (0.854)	1.61 (0.621)	2.05 (0.488)	2.40 (0.416)	2.84 (0.352)
100 mm concrete with deck	0.92 (1.086)	1.21 (0.826)	1.65 (0.606)	2.09 (0.478)	2.44 (0.410)	2.88 (0.347)
150 mm concrete with deck	0.94 (1.063)	1.23 (0.812)	1.67 (0.598)	2.11 (0.474)	2.46 (0.406)	2.90 (0.345)
precast concrete	0.92 (1.087)	1.21 (0.826)	1.65 (0.606)	2.09 (0.478)	2.44 (0.410)	2.88 (0.347)
	Interior Finish					
	13 mm gypsum board	13 mm plywood	hung ceiling	strapping and 13 mm gypsum board		
RSI Adjustment	0.08	0.11	0.26	0.23		
<p>Example: 100 mm concrete deck with RSI 0.68 insulation</p> $RSI_T = \text{Exterior Air} + \text{Built-Up Roofing} + \text{Insulation} + \text{100 mm concrete} + \text{Metal Deck} + \text{Interior Air}$ $= 0.03 + 0.06 + 0.68 + 0.04 + \text{negligible} + 0.11$ $= 0.92$						

### Notes to Table B-4:

- (1) To convert insulation RSI to insulation thickness, see Table B-1.  
 (2) No credit for materials to the exterior of vented air space.

**Table B-5**  
**Roof: Flat, Truss or Wood I-Joist-Type**  
 Trusses or I-Joists with 13 mm gypsum board interior finish

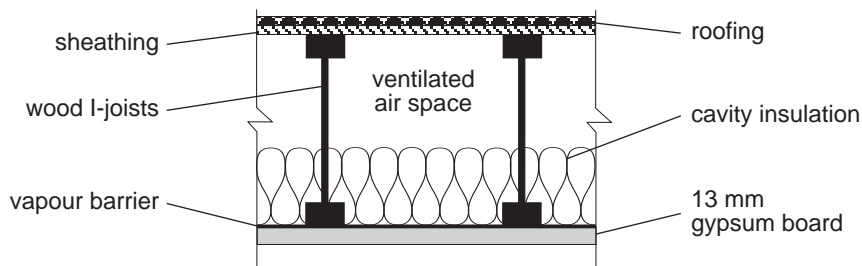

Truss Spacing	Cavity Insulation <sup>(1)(2)</sup>					
	RSI 2.46	RSI 3.52	RSI 4.93	RSI 5.46	RSI 6.16	RSI 7.04
	Effective RSI (Overall U-Value) <sup>(3)(4)</sup>					
trusses or I-Joists @ 406 mm o.c.	2.49 (0.401)	3.55 (0.282)	4.88 (0.205)	5.38 (0.186)	6.05 (0.165)	6.85 (0.146)
trusses or I-Joists @ 610 mm o.c.	2.55 (0.393)	3.60 (0.278)	4.96 (0.202)	5.47 (0.183)	6.15 (0.163)	6.97 (0.144)
	Interior Finish					
	13 mm plywood	hung ceiling	strapping			
RSI Adjustment	0.03	0.18	0.15			
<p>Example: wood I-Joists @ 406 mm o.c. with RSI 3.52 cavity insulation</p> $RSI_{Fweb} = \text{Exterior Air} + \text{Wood Web (to top of insulation)} + 13 \text{ mm Gypsum} + \text{Interior Air}$ $= 0.03 + (152 \times 0.0081) + 0.0793 + 0.11$ $= 1.4505$ $RSI_{Fflange} = \text{Exterior Air} + 38 \text{ mm Wood Flange} + \text{Insulation} + 13 \text{ mm Gypsum} + \text{Interior Air}$ $= 0.03 + 0.308 + (3.52 \div (152 \times (152 - 38))) + 0.0793 + 0.11$ $= 3.1673$ $RSI_i = \text{Exterior Air} + \text{Insulation} + 13 \text{ mm Gypsum} + \text{Interior Air}$ $= 0.03 + 3.52 + 0.0793 + 0.11$ $= 3.7393$ <p>Assuming that the thickness of the I-Joist web is 25% of the width of the flanges:</p> $RSI_T = 1 \div (((0.25 \times 0.1) \div RSI_{Fweb}) + ((0.75 \times 0.1) \div RSI_{Fflange}) + (0.9 \div RSI_i))$ $= 3.55$						

**Notes to Table B-5:**

- (1) To convert insulation RSI to insulation thickness, see Table B-1.
- (2) Glass/mineral fibre batts used to determine insulation thickness.
- (3) The effective thermal resistance and overall thermal transmittance values given have been calculated using framing percentages listed in Table C-1 of Appendix C.
- (4) No credit for materials to the exterior of vented air space.

## Appendix B

**Table B-6**  
**Metal Frame Wall: 41 x 92 mm @ 406 mm o.c.**  
 with aluminum or vinyl siding exterior finish and 13 mm gypsum board interior finish

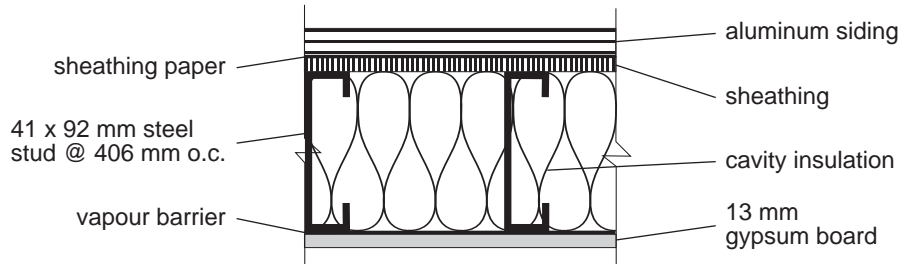

Sheathing <sup>(2)</sup>	Cavity Insulation <sup>(1)</sup>				
	no insulation	RSI 2.11	RSI 2.29	RSI 2.46	RSI 3.70
	Effective RSI (Overall U-Value) <sup>(3)</sup>				
no sheathing	0.48 (2.093)	1.16 (0.859)	1.22 (0.820)	1.27 (0.786)	1.65 (0.608)
13 mm gypsum	0.56 (1.795)	1.25 (0.802)	1.30 (0.767)	1.36 (0.736)	1.74 (0.575)
11 mm plywood or particle board	0.57 (1.744)	1.26 (0.791)	1.32 (0.757)	1.38 (0.727)	1.76 (0.569)
11 mm waferboard or OSB	0.60 (1.670)	1.29 (0.775)	1.35 (0.742)	1.40 (0.713)	1.79 (0.560)
11 mm fibreboard	0.66 (1.519)	1.35 (0.739)	1.41 (0.709)	1.46 (0.683)	1.85 (0.540)
RSI 0.88 sheathing	1.36 (0.734)	2.19 (0.457)	2.26 (0.443)	2.32 (0.430)	2.81 (0.356)
RSI 1.05 sheathing	1.53 (0.652)	2.36 (0.424)	2.43 (0.412)	2.50 (0.401)	2.98 (0.336)
RSI 1.14 sheathing	1.62 (0.616)	2.45 (0.409)	2.52 (0.397)	2.59 (0.387)	3.07 (0.326)
RSI 1.32 sheathing	1.80 (0.555)	2.63 (0.380)	2.70 (0.370)	2.77 (0.361)	3.25 (0.307)
	Exterior Finish				
	13 mm stucco	wood siding	100 mm brick and 25 mm air	19 mm furring behind finish	
RSI Adjustment	-0.10	0.04	0.14	0.18	
	Interior Finish				
	6 mm wood paneling	16 mm gypsum board	strapped air space		
RSI Adjustment	-0.02	0.02	0.19		

**Table B-6 (Continued)**

<p>Example: RSI 0.88 sheathing with RSI 2.29 cavity insulation</p> $RSI_F = \text{Exterior Air} + \text{Aluminum Siding} + \text{Sheathing Paper} + \text{Sheathing} + 92 \text{ mm Steel Framing} + 13 \text{ mm Gypsum} + \text{Interior Air}$ $= 0.03 + 0.11 + 0.011 + 0.88 + 0.0014812 + 0.0793 + 0.12$ $= 1.2318$ $RSI_I = \text{Exterior Air} + \text{Aluminum Siding} + \text{Sheathing Paper} + \text{Sheathing} + \text{Insulation} + 13 \text{ mm Gypsum} + \text{Interior Air}$ $= 0.03 + 0.11 + 0.011 + 0.88 + 2.29 + 0.0793 + 0.12$ $= 3.5203$ $RSI_{T1} = 1 \div ((0.0063 \div RSI_F) + (0.9937 \div RSI_I))$ $= 3.4796$ $RSI_{T2} = 1 \div ((0.0063 \div \text{RSI of Steel Framing}) + (0.9937 \div \text{RSI of Insulation}))$ $= 1 \div ((0.0063 \div 0.0014812) + (0.9937 \div 2.29))$ $= 0.2133$ $RSI_{T3} = RSI_{T2} + \text{Exterior Air} + \text{Aluminum Siding} + \text{Sheathing Paper} + \text{Sheathing} + 13 \text{ mm Gypsum} + \text{Interior Air}$ $= 0.2133 + 0.03 + 0.11 + 0.011 + 0.88 + 0.0793 + 0.12$ $= 1.4436$ $RSI_T = ((2 \times RSI_{T1}) + (3 \times RSI_{T3})) \div 5$ $= 2.26$
---

**Notes to Table B-6:**

- (1) To convert insulation RSI to insulation thickness, see Table B-1.
- (2) For other insulating sheathings, add the sheathing RSI value to the 'no sheathing' category.
- (3) The effective thermal resistance and overall thermal transmittance values given have been calculated using framing percentages listed in Table C-1 of Appendix C.

## Appendix B

**Table B-7**  
**Metal Frame Wall: 41 x 92 mm @ 610 mm o.c.**  
 with aluminum or vinyl siding exterior finish and 13 mm gypsum board interior finish

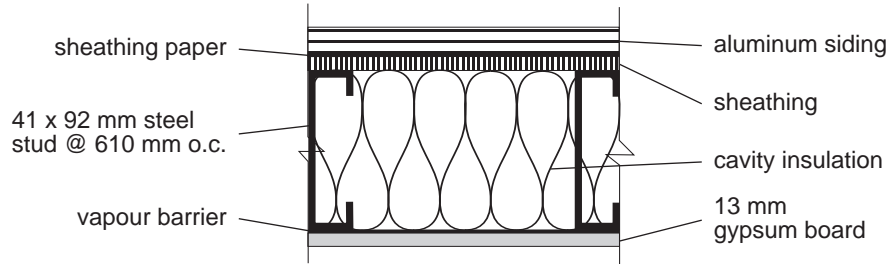

Sheathing <sup>(2)</sup>	Cavity Insulation <sup>(1)</sup>				
	no insulation	RSI 2.11	RSI 2.29	RSI 2.46	RSI 3.70
	Effective RSI (Overall U-Value) <sup>(3)</sup>				
no sheathing	0.50 (1.991)	1.55 (0.646)	1.64 (0.611)	1.72 (0.582)	2.31 (0.434)
13 mm gypsum	0.58 (1.720)	1.63 (0.613)	1.72 (0.581)	1.80 (0.555)	2.40 (0.417)
11 mm plywood or particle board	0.60 (1.672)	1.65 (0.607)	1.74 (0.576)	1.82 (0.549)	2.42 (0.414)
11 mm waferboard or OSB	0.62 (1.605)	1.67 (0.597)	1.76 (0.567)	1.85 (0.541)	2.44 (0.409)
11 mm fibreboard	0.68 (1.465)	1.74 (0.576)	1.83 (0.548)	1.91 (0.524)	2.51 (0.398)
RSI 0.88 sheathing	1.38 (0.723)	2.44 (0.409)	2.53 (0.395)	2.62 (0.382)	3.24 (0.309)
RSI 1.05 sheathing	1.55 (0.644)	2.61 (0.382)	2.71 (0.370)	2.79 (0.358)	3.41 (0.293)
RSI 1.14 sheathing	1.64 (0.609)	2.71 (0.370)	2.80 (0.358)	2.88 (0.347)	3.50 (0.286)
RSI 1.32 sheathing	1.82 (0.549)	2.89 (0.347)	2.98 (0.336)	3.06 (0.327)	3.68 (0.272)
	Exterior Finish				
	13 mm stucco	wood siding	100 mm brick and 25 mm air	19 mm furring behind finish	
RSI Adjustment	-0.10	0.04	0.14	0.18	
	Interior Finish				
	6 mm wood paneling	16 mm gypsum board	strapped air space		
RSI Adjustment	-0.02	0.02	0.19		

**Table B-7 (Continued)**

Example: RSI 0.88 sheathing with RSI 2.29 cavity insulation

$$\begin{aligned} RSI_F &= \text{Exterior Air} + \text{Aluminum Siding} + \text{Sheathing Paper} + \text{Sheathing} + 92 \text{ mm Steel Framing} \\ &\quad + 13 \text{ mm Gypsum} + \text{Interior Air} \\ &= 0.03 + 0.11 + 0.011 + 0.88 + 0.0014812 + 0.0793 + 0.12 \\ &= 1.2318 \end{aligned}$$

$$\begin{aligned} RSI_I &= \text{Exterior Air} + \text{Aluminum Siding} + \text{Sheathing Paper} + \text{Sheathing} + \text{Insulation} + 13 \text{ mm Gypsum} \\ &\quad + \text{Interior Air} \\ &= 0.03 + 0.11 + 0.011 + 0.88 + 2.29 + 0.0793 + 0.12 \\ &= 3.5203 \end{aligned}$$

$$\begin{aligned} RSI_{T1} &= 1 \div ((0.0037 \div RSI_F) + (0.9963 \div RSI_I)) \\ &= 3.4963 \end{aligned}$$

$$\begin{aligned} RSI_{T2} &= 1 \div ((0.0037 \div \text{RSI of Steel Framing}) + (0.9963 \div \text{RSI of Insulation})) \\ &= 1 \div ((0.0037 \div 0.0014812) + (0.9963 \div 2.29)) \\ &= 0.3409 \end{aligned}$$

$$\begin{aligned} RSI_{T3} &= RSI_{T2} + \text{Exterior Air} + \text{Aluminum Siding} + \text{Sheathing Paper} + \text{Sheathing} + 13 \text{ mm Gypsum} + \text{Interior Air} \\ &= 0.3409 + 0.03 + 0.11 + 0.011 + 0.88 + 0.0793 + 0.12 \\ &= 1.5712 \end{aligned}$$

$$\begin{aligned} RSI_T &= (RSI_{T1} + RSI_{T3}) \div 2 \\ &= 2.53 \end{aligned}$$

**Notes to Table B-7:**

- (1) To convert insulation RSI to insulation thickness, see Table B-1.
- (2) For other insulating sheathings, add the sheathing RSI value to the 'no sheathing' category.
- (3) The effective thermal resistance and overall thermal transmittance values given have been calculated using framing percentages listed in Table C-1 of Appendix C.

## Appendix B

**Table B-8**  
**Metal Frame Wall: 41 x 152 mm @ 406 mm o.c.**  
 with aluminum or vinyl siding exterior finish and 13 mm gypsum board interior finish

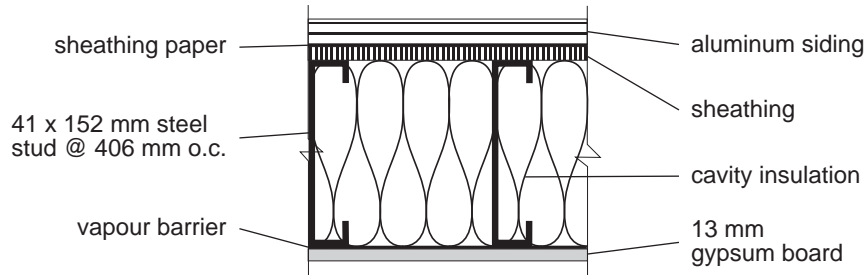

Sheathing <sup>(2)</sup>	Cavity Insulation <sup>(1)</sup>			
	no insulation	RSI 3.52	RSI 3.87	RSI 6.4
	Effective RSI (Overall U-Value) <sup>(3)</sup>			
no sheathing	0.49 (2.033)	1.68 (0.596)	1.78 (0.561)	2.49 (0.401)
13 mm gypsum	0.57 (1.751)	1.77 (0.565)	1.88 (0.533)	2.61 (0.383)
11 mm plywood or particle board	0.59 (1.702)	1.79 (0.559)	1.90 (0.528)	2.63 (0.380)
11 mm waferboard or OSB	0.61 (1.631)	1.82 (0.551)	1.92 (0.520)	2.67 (0.375)
11 mm fibreboard	0.67 (1.487)	1.88 (0.532)	1.99 (0.503)	2.74 (0.365)
RSI 0.88 sheathing	1.38 (0.727)	2.81 (0.355)	2.95 (0.339)	3.91 (0.256)
RSI 1.05 sheathing	1.55 (0.647)	2.99 (0.335)	3.12 (0.320)	4.09 (0.244)
RSI 1.14 sheathing	1.64 (0.611)	3.08 (0.325)	3.21 (0.311)	4.18 (0.239)
RSI 1.32 sheathing	1.82 (0.551)	3.26 (0.307)	3.40 (0.294)	4.37 (0.229)
	Exterior Finish			
	13 mm stucco	wood siding	100 mm brick and 25 mm air	19 mm furring behind finish
RSI Adjustment	-0.10	0.04	0.14	0.18
	Interior Finish			
	6 mm wood paneling	16 mm gypsum board	strapped air space	
RSI Adjustment	-0.02	0.02	0.19	

**Table B-8 (Continued)**

Example: RSI 0.88 sheathing with RSI 3.52 cavity insulation

$$\begin{aligned} RSI_F &= \text{Exterior Air} + \text{Aluminum Siding} + \text{Sheathing Paper} + \text{Sheathing} + 152 \text{ mm Steel Framing} \\ &\quad + 13 \text{ mm Gypsum} + \text{Interior Air} \\ &= 0.03 + 0.11 + 0.011 + 0.88 + 0.0024472 + 0.0793 + 0.12 \\ &= 1.2328 \end{aligned}$$

$$\begin{aligned} RSI_I &= \text{Exterior Air} + \text{Aluminum Siding} + \text{Sheathing Paper} + \text{Sheathing} + \text{Insulation} + 13 \text{ mm Gypsum} \\ &\quad + \text{Interior Air} \\ &= 0.03 + 0.11 + 0.011 + 0.88 + 3.52 + 0.0793 + 0.12 \\ &= 4.7503 \end{aligned}$$

$$\begin{aligned} RSI_{T1} &= 1 \div ((0.0063 \div RSI_F) + (0.9937 \div RSI_I)) \\ &= 4.6664 \end{aligned}$$

$$\begin{aligned} RSI_{T2} &= 1 \div ((0.0063 \div \text{RSI of Steel Framing}) + (0.9937 \div \text{RSI of Insulation})) \\ &= 1 \div ((0.0063 \div 0.0024472) + (0.9937 \div 3.52)) \\ &= 0.3501 \end{aligned}$$

$$\begin{aligned} RSI_{T3} &= RSI_{T2} + \text{Exterior Air} + \text{Aluminum Siding} + \text{Sheathing Paper} + \text{Sheathing} + 13 \text{ mm Gypsum} + \text{Interior Air} \\ &= 0.3501 + 0.03 + 0.11 + 0.011 + 0.88 + 0.0793 + 0.12 \\ &= 1.5804 \end{aligned}$$

$$\begin{aligned} RSI_T &= ((2 \times RSI_{T1}) + (3 \times RSI_{T3})) \div 5 \\ &= 2.81 \end{aligned}$$

**Notes to Table B-8:**

- (1) To convert insulation RSI to insulation thickness, see Table B-1.
- (2) For other insulating sheathings, add the sheathing RSI value to the 'no sheathing' category.
- (3) The effective thermal resistance and overall thermal transmittance values given have been calculated using framing percentages listed in Table C-1 of Appendix C.

## Appendix B

**Table B-9**  
**Metal Frame Wall: 41 x 152 mm @ 610 mm o.c.**  
 with aluminum or vinyl siding exterior finish and 13 mm gypsum board interior finish

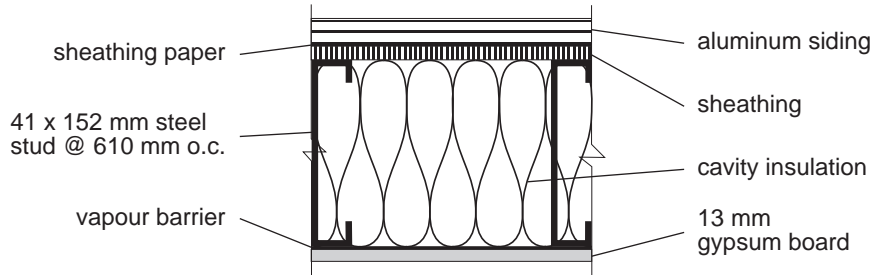

Sheathing <sup>(2)</sup>	Cavity Insulation <sup>(1)</sup>			
	no insulation	RSI 3.52	RSI 3.87	RSI 6.40
Effective RSI (Overall U-Value) <sup>(3)</sup>				
no sheathing	0.51 (1.957)	2.32 (0.431)	2.49 (0.402)	3.64 (0.275)
13 mm gypsum	0.59 (1.694)	2.41 (0.415)	2.58 (0.388)	3.75 (0.266)
11 mm plywood or particle board	0.61 (1.649)	2.43 (0.411)	2.60 (0.385)	3.78 (0.265)
11 mm waferboard or OSB	0.63 (1.583)	2.46 (0.407)	2.63 (0.381)	3.81 (0.262)
11 mm fibreboard	0.69 (1.447)	2.52 (0.396)	2.69 (0.371)	3.89 (0.257)
RSI 0.88 sheathing	1.39 (0.719)	3.25 (0.308)	3.42 (0.292)	4.66 (0.215)
RSI 1.05 sheathing	1.56 (0.641)	3.42 (0.293)	3.59 (0.278)	4.84 (0.207)
RSI 1.14 sheathing	1.65 (0.606)	3.51 (0.285)	3.68 (0.271)	4.93 (0.203)
RSI 1.32 sheathing	1.83 (0.546)	3.69 (0.271)	3.87 (0.259)	5.12 (0.195)
Exterior Finish				
	13 mm stucco	wood siding	100 mm brick and 25 mm air	19 mm furring behind finish
RSI Adjustment	-0.10	0.04	0.14	0.18
Interior Finish				
	6 mm wood paneling	16 mm gypsum board	strapped air space	
RSI Adjustment	-0.02	0.02	0.19	

**Table B-9 (Continued)**

<p>Example: RSI 0.88 sheathing with RSI 3.52 cavity insulation</p> $\begin{aligned} \text{RSI}_F &= \text{Exterior Air} + \text{Aluminum Siding} + \text{Sheathing Paper} + \text{Sheathing} + 92 \text{ mm Steel Framing} \\ &\quad + 13 \text{ mm Gypsum} + \text{Interior Air} \\ &= 0.03 + 0.11 + 0.011 + 0.88 + 0.0014812 + 0.0793 + 0.12 \\ &= 1.2327 \end{aligned}$ $\begin{aligned} \text{RSI}_I &= \text{Exterior Air} + \text{Aluminum Siding} + \text{Sheathing Paper} + \text{Sheathing} + \text{Insulation} + 13 \text{ mm Gypsum} \\ &\quad + \text{Interior Air} \\ &= 0.03 + 0.11 + 0.011 + 0.88 + 3.52 + 0.0793 + 0.12 \\ &= 4.7503 \end{aligned}$ $\begin{aligned} \text{RSI}_{T1} &= 1 \div ((0.0037 \div \text{RSI}_F) + (0.9963 \div \text{RSI}_I)) \\ &= 4.7007 \end{aligned}$ $\begin{aligned} \text{RSI}_{T2} &= 1 \div ((0.0037 \div \text{RSI of Steel Framing}) + (0.9963 \div \text{RSI of Insulation})) \\ &= 1 \div ((0.0037 \div 0.0024472) + (0.9963 \div 3.52)) \\ &= 0.5571 \end{aligned}$ $\begin{aligned} \text{RSI}_{T3} &= \text{RSI}_{T2} + \text{Exterior Air} + \text{Aluminum Siding} + \text{Sheathing Paper} + \text{Sheathing} + 13 \text{ mm Gypsum} + \text{Interior Air} \\ &= 0.5571 + 0.03 + 0.11 + 0.011 + 0.88 + 0.0793 + 0.12 \\ &= 1.7874 \end{aligned}$ $\begin{aligned} \text{RSI}_T &= (\text{RSI}_{T1} + \text{RSI}_{T3}) \div 2 \\ &= 3.25 \end{aligned}$
--

**Notes to Table B-9:**

- (1) To convert insulation RSI to insulation thickness, see Table B-1.
- (2) For other insulating sheathings, add the sheathing RSI value to the 'no sheathing' category.
- (3) The effective thermal resistance and overall thermal transmittance values given have been calculated using framing percentages listed in Table C-1 of Appendix C.

## Appendix B

**Table B-10**  
**Wood Frame Wall: 38 x 89 mm @ 406 mm o.c.**  
 with aluminum or vinyl siding exterior finish and 13 mm gypsum board interior finish

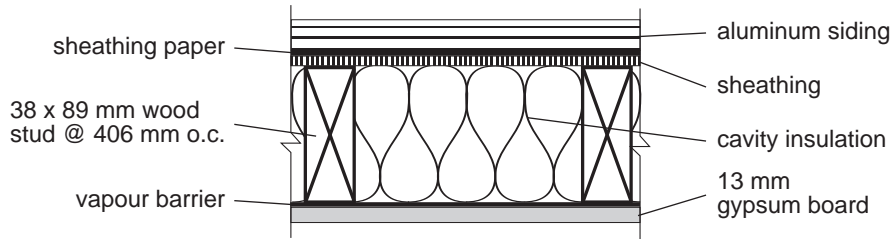

Sheathing <sup>(2)</sup>	Cavity Insulation <sup>(1)</sup>				
	no insulation	RSI 2.11	RSI 2.29	RSI 2.46	RSI 3.70
Effective RSI (Overall U-Value) <sup>(3)</sup>					
no sheathing	0.59 (1.705)	1.97 (0.507)	2.07 (0.484)	2.15 (0.466)	2.65 (0.377)
13 mm gypsum	0.67 (1.494)	2.07 (0.484)	2.16 (0.463)	2.24 (0.445)	2.77 (0.361)
11 mm plywood or particle board	0.69 (1.457)	2.08 (0.480)	2.18 (0.459)	2.26 (0.442)	2.79 (0.358)
11 mm waferboard or OSB	0.71 (1.403)	2.11 (0.473)	2.21 (0.453)	2.30 (0.436)	2.83 (0.354)
11 mm fibreboard	0.77 (1.292)	2.18 (0.459)	2.28 (0.439)	2.37 (0.423)	2.91 (0.343)
RSI 0.88 sheathing	1.49 (0.672)	2.94 (0.340)	3.05 (0.327)	3.16 (0.317)	3.82 (0.262)
RSI 1.05 sheathing	1.66 (0.602)	3.12 (0.320)	3.24 (0.309)	3.34 (0.299)	4.03 (0.248)
RSI 1.14 sheathing	1.75 (0.571)	3.22 (0.311)	3.33 (0.300)	3.44 (0.291)	4.13 (0.242)
RSI 1.32 sheathing	1.93 (0.517)	3.40 (0.294)	3.52 (0.284)	3.63 (0.276)	4.34 (0.230)
Exterior Finish					
	13 mm stucco	wood siding	100 mm brick and 25 mm air	19 mm furring behind finish	
RSI Adjustment	-0.10	0.04	0.14	0.18	
Interior Finish					
	6 mm wood paneling	16 mm gypsum board	strapped air space		
RSI Adjustment	-0.02	0.02	0.19		

**Table B-10 (Continued)**

<p>Example: RSI 0.88 sheathing with RSI 2.29 cavity insulation</p> $\begin{aligned} \text{RSI}_F &= \text{Exterior Air} + \text{Aluminum Siding} + \text{Sheathing Paper} + \text{Sheathing} + 89 \text{ mm Wood} + 13 \text{ mm Gypsum} \\ &\quad + \text{Interior Air} \\ &= 0.03 + 0.11 + 0.011 + 0.88 + 0.7209 + 0.0793 + 0.12 \\ &= 1.9512 \end{aligned}$ $\begin{aligned} \text{RSI}_I &= \text{Exterior Air} + \text{Aluminum Siding} + \text{Sheathing Paper} + \text{Sheathing} + \text{Insulation} + 13 \text{ mm Gypsum} \\ &\quad + \text{Interior Air} \\ &= 0.03 + 0.11 + 0.011 + 0.88 + 2.29 + 0.0793 + 0.12 \\ &= 3.5203 \end{aligned}$ $\begin{aligned} \text{RSI}_T &= 1 \div ((0.19 \div \text{RSI}_F) + (0.81 \div \text{RSI}_I)) \\ &= 3.05 \end{aligned}$
---

**Notes to Table B-10:**

- (1) To convert insulation RSI to insulation thickness, see Table B-1.
- (2) For other insulating sheathings, add the sheathing RSI value to the 'no sheathing' category.
- (3) The effective thermal resistance and overall thermal transmittance values given have been calculated using framing percentages listed in Table C-1 of Appendix C.

## Appendix B

**Table B-11**  
**Wood Frame Wall: Double Studs @ 406 mm o.c.**  
 with aluminum or vinyl siding exterior finish and 13 mm gypsum board interior finish

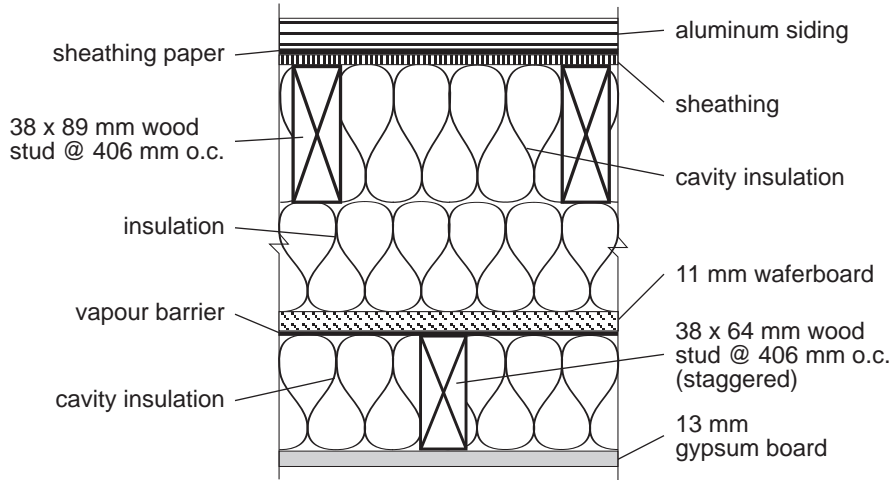

Structure	Cavity Insulation <sup>(1)</sup>			
	RSI 4.58	RSI 5.63	RSI 7.04	RSI 7.39
Effective RSI (Overall U-Value), No Sheathing <sup>(2)</sup>				
38 x 89 mm and 38 x 64 mm staggered	4.52 (0.221)	5.59 (0.179)	7.01 (0.143)	7.36 (0.136)
38 x 89 mm and 38 x 64 mm unstaggered	4.32 (0.231)	5.44 (0.184)	6.91 (0.145)	7.27 (0.138)
38 x 89 mm and 38 x 89 mm staggered	4.42 (0.226)	5.49 (0.182)	6.92 (0.145)	7.27 (0.137)
38 x 89 mm and 38 x 89 mm unstaggered	4.11 (0.243)	5.27 (0.190)	6.77 (0.148)	7.13 (0.140)
Exterior Finish				
	13 mm stucco	wood siding	100 mm brick and 25 mm air	19 mm furring behind finish
RSI Adjustment	-0.10	0.04	0.14	0.18
Sheathing <sup>(3)</sup>				
	13 mm gypsum	11 mm plywood or particle board	11 mm waferboard or OSB	11 mm fibreboard
RSI Adjustment	0.08	0.10	0.12	0.18
Interior Finish				
	6 mm wood paneling	16 mm gypsum board	strapped air space	
RSI Adjustment	-0.02	0.02	0.19	

**Table B-11 (Continued)**

<p>Example: 38 x 89 mm and 38 x 64 mm staggered, no sheathing, with RSI 5.63 cavity insulation</p> <p> <math>RSI_{F1}</math> = Exterior Air + Aluminum Siding + Sheathing Paper + 89 mm Wood + Insulation (between stud rows)  + 11 mm Waferboard + Insulation (interior) + 13 mm Gypsum + Interior Air  = 0.03 + 0.11 + 0.011 + 0.7209 + (5.63 - 0.0236 × (89 + 64)) + 0.121 + (0.0236 × 64) + 0.0793 + 0.12  = 4.7218 </p> <p> <math>RSI_{F2}</math> = Exterior Air + Aluminum Siding + Sheathing Paper + Insulation (exterior)  + Insulation (between stud rows) + 11 mm Waferboard + 64 mm Wood + 13 mm Gypsum + Interior Air  = 0.03 + 0.11 + 0.011 + (0.0236 × 89) + (5.63 - 0.0236 × (89 + 64)) + 0.121 + 0.5184 + 0.0793 + 0.12  = 5.1093 </p> <p> <math>RSI_i</math> = Exterior Air + Aluminum Siding + Sheathing Paper + Insulation + 11 mm Waferboard + 13 mm Gypsum  + Interior Air  = 0.03 + 0.11 + 0.011 + 5.63 + 0.121 + 0.0793 + 0.12  = 6.1013 </p> <p> <math>RSI_T</math> = <math>1 \div ((0.19 \div RSI_{F1}) + (0.19 \div RSI_{F2}) + ((1 - (2 \times 0.19)) \div RSI_i))</math>  = 5.59 </p>
---

**Notes to Table B-11:**

- (1) To convert insulation RSI to insulation thickness, see Table B-1.
- (2) The effective thermal resistance and overall thermal transmittance values given have been calculated using framing percentages listed in Table C-1 of Appendix C.
- (3) For other insulated sheathings, add the sheathing RSI to total RSI.

## Appendix B

**Table B-12**  
**Wood Frame Wall: 38 x 140 mm @ 406 mm o.c.**  
 with aluminum or vinyl siding exterior finish and 13 mm gypsum board interior finish

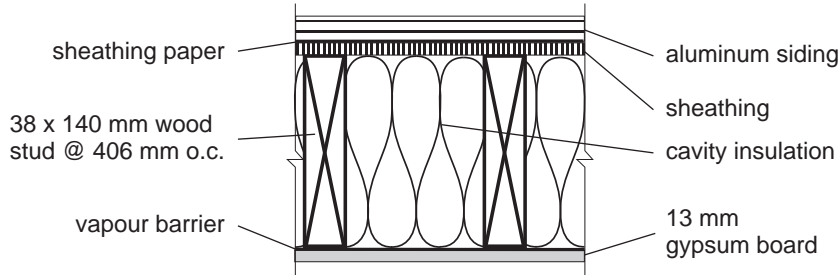

Sheathing <sup>(2)</sup>	Cavity Insulation <sup>(1)</sup>					
	no insulation	RSI 3.25	RSI 3.34	RSI 3.52	RSI 3.87	RSI 5.90
	Effective RSI (Overall U-Value) <sup>(3)</sup>					
no sheathing	0.60 (1.655)	2.83 (0.353)	2.88 (0.348)	2.96 (0.337)	3.13 (0.320)	3.88 (0.258)
13 mm gypsum	0.69 (1.450)	2.93 (0.342)	2.97 (0.336)	3.06 (0.327)	3.23 (0.310)	4.01 (0.249)
11 mm plywood or particle board	0.71 (1.414)	2.95 (0.339)	2.99 (0.334)	3.08 (0.324)	3.25 (0.308)	4.03 (0.248)
11 mm waferboard or OSB	0.73 (1.362)	2.98 (0.336)	3.02 (0.331)	3.11 (0.321)	3.28 (0.305)	4.07 (0.245)
11 mm fibreboard	0.80 (1.254)	3.05 (0.328)	3.09 (0.323)	3.18 (0.314)	3.35 (0.298)	4.17 (0.240)
RSI 0.88 sheathing	1.53 (0.655)	3.83 (0.261)	3.88 (0.258)	3.99 (0.251)	4.18 (0.239)	5.16 (0.194)
RSI 1.05 sheathing	1.70 (0.588)	4.01 (0.249)	4.07 (0.246)	4.17 (0.240)	4.37 (0.229)	5.38 (0.186)
RSI 1.14 sheathing	1.79 (0.557)	4.11 (0.243)	4.17 (0.240)	4.27 (0.234)	4.47 (0.224)	5.49 (0.182)
RSI 1.32 sheathing	1.98 (0.506)	4.30 (0.232)	4.36 (0.229)	4.47 (0.224)	4.67 (0.214)	5.72 (0.175)
	Exterior Finish					
	13 mm stucco	wood siding	100 mm brick and 25 mm air	19 mm furring behind finish		
RSI Adjustment	-0.10	0.04	0.14	0.18		
	Interior Finish					
	6 mm wood paneling	16 mm gypsum board	strapped air space			
RSI Adjustment	-0.02	0.02	0.19			

**Table B-12 (Continued)**

<p>Example: RSI 0.88 sheathing with RSI 3.52 cavity insulation</p> $RSI_F = \text{Exterior Air} + \text{Aluminum Siding} + \text{Sheathing Paper} + \text{Sheathing} + 140 \text{ mm Wood} + 13 \text{ mm Gypsum} + \text{Interior Air}$ $= 0.03 + 0.11 + 0.011 + 0.88 + 1.134 + 0.0793 + 0.12$ $= 2.3643$ $RSI_I = \text{Exterior Air} + \text{Aluminum Siding} + \text{Sheathing Paper} + \text{Sheathing} + \text{Insulation} + 13 \text{ mm Gypsum} + \text{Interior Air}$ $= 0.03 + 0.11 + 0.011 + 0.88 + 3.52 + 0.0793 + 0.12$ $= 4.7503$ $RSI_T = 1 \div ((0.19 \div RSI_F) + (0.81 \div RSI_I))$ $= 3.99$
---

**Notes to Table B-12:**

- (1) To convert insulation RSI to insulation thickness, see Table B-1.
- (2) For other insulating sheathings, add the sheathing RSI value to the 'no sheathing' category.
- (3) The effective thermal resistance and overall thermal transmittance values given have been calculated using framing percentages listed in Table C-1 of Appendix C.

## Appendix B

**Table B-13**  
**Wood Frame Wall: 38 x 140 mm @ 610 mm o.c.**  
 with aluminum or vinyl siding exterior finish and 13 mm gypsum board interior finish

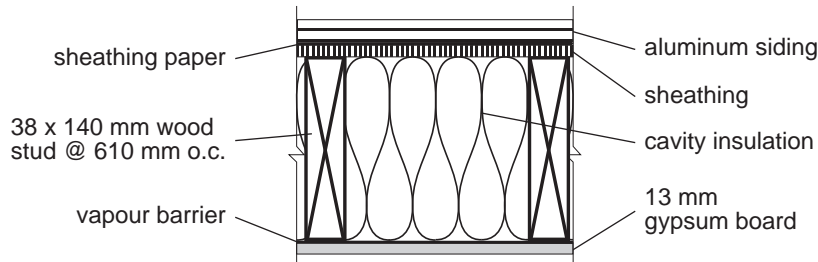

Sheathing <sup>(2)</sup>	Cavity Insulation <sup>(1)</sup>					
	no insulation	RSI 3.25	RSI 3.34	RSI 3.52	RSI 3.87	RSI 5.90
	Effective RSI (Overall U-Value) <sup>(3)</sup>					
no sheathing	0.57 (1.752)	3.11 (0.321)	3.17 (0.315)	3.29 (0.304)	3.51 (0.285)	4.62 (0.217)
13 mm gypsum	0.65 (1.530)	3.20 (0.312)	3.26 (0.306)	3.38 (0.296)	3.61 (0.277)	4.74 (0.211)
11 mm plywood or particle board	0.67 (1.491)	3.22 (0.310)	3.28 (0.305)	3.40 (0.294)	3.63 (0.276)	4.76 (0.210)
11 mm waferboard or OSB	0.70 (1.435)	3.25 (0.308)	3.31 (0.302)	3.43 (0.292)	3.66 (0.274)	4.80 (0.208)
11 mm fibreboard	0.76 (1.318)	3.32 (0.301)	3.38 (0.296)	3.50 (0.286)	3.73 (0.268)	4.89 (0.204)
RSI 0.88 sheathing	1.48 (0.678)	4.08 (0.245)	4.14 (0.241)	4.28 (0.234)	4.52 (0.221)	5.84 (0.171)
RSI 1.05 sheathing	1.65 (0.607)	4.26 (0.235)	4.33 (0.231)	4.46 (0.224)	4.71 (0.212)	6.05 (0.165)
RSI 1.14 sheathing	1.74 (0.575)	4.35 (0.230)	4.42 (0.226)	4.55 (0.220)	4.81 (0.208)	6.16 (0.162)
RSI 1.32 sheathing	1.92 (0.520)	4.54 (0.220)	4.61 (0.217)	4.75 (0.211)	5.00 (0.200)	6.38 (0.157)
	Exterior Finish					
	13 mm stucco	wood siding	100 mm brick and 25 mm air	19 mm furring behind finish		
RSI Adjustment	-0.10	0.04	0.14	0.18		
	Interior Finish					
	6 mm wood paneling	16 mm gypsum board	strapped air space			
RSI Adjustment	-0.02	0.02	0.19			

**Table B-13 (Continued)**

<p>Example: RSI 0.88 sheathing with RSI 3.52 cavity insulation</p> $\begin{aligned} \text{RSI}_F &= \text{Exterior Air} + \text{Aluminum Siding} + \text{Sheathing Paper} + \text{Sheathing} + 140 \text{ mm Wood} \\ &\quad + 13 \text{ mm Gypsum} + \text{Interior Air} \\ &= 0.03 + 0.11 + 0.011 + 0.88 + 1.134 + 0.0793 + 0.12 \\ &= 2.3643 \end{aligned}$ $\begin{aligned} \text{RSI}_I &= \text{Exterior Air} + \text{Aluminum Siding} + \text{Sheathing Paper} + \text{Sheathing} + \text{Insulation} \\ &\quad + 13 \text{ mm Gypsum} + \text{Interior Air} \\ &= 0.03 + 0.11 + 0.011 + 0.88 + 3.52 + 0.0793 + 0.12 \\ &= 4.7503 \end{aligned}$ $\begin{aligned} \text{RSI}_T &= 1 \div ((0.11 \div \text{RSI}_F) + (0.89 \div \text{RSI}_I)) \\ &= 4.28 \end{aligned}$
---

**Notes to Table B-13:**

- (1) To convert insulation RSI to insulation thickness, see Table B-1.
- (2) For other insulating sheathings, add the sheathing RSI value to the 'no sheathing' category.
- (3) The effective thermal resistance and overall thermal transmittance values given have been calculated using framing percentages listed in Table C-1 of Appendix C.

## Appendix B

**Table B-14**  
**Masonry Wall: 190 mm Concrete Block (Normal Weight) with/without Wood Framing**  
 with no exterior finish and 13 mm gypsum board interior finish

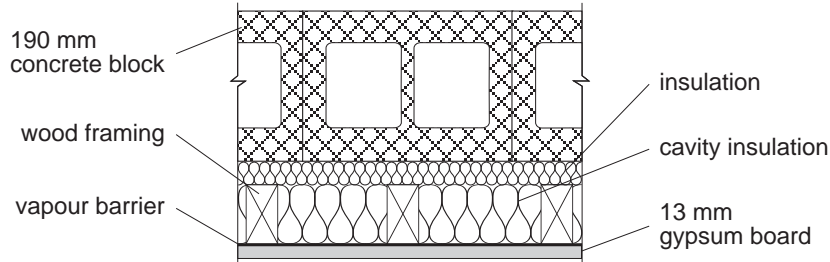

	Total Insulation <sup>(1)(2)</sup>				
	no insulation	RSI 1.41	RSI 2.11	RSI 2.29	RSI 2.46
Framing/Spacing	Effective RSI (Overall U-Value) <sup>(3)</sup>				
no framing	0.44 (2.276)	-	-	-	-
38 x 64 mm @ 406 mm o.c.	0.66 (1.506)	1.57 (0.636)	2.27 (0.440)	2.41 (0.415)	2.53 (0.395)
38 x 64 mm @ 610 mm o.c.	0.64 (1.552)	1.68 (0.596)	2.38 (0.420)	2.53 (0.395)	2.68 (0.374)
38 x 89 mm @ 406 mm o.c.	0.68 (1.472)	1.78 (0.563)	2.08 (0.481)	2.17 (0.461)	2.26 (0.443)
38 x 89 mm @ 610 mm o.c.	0.65 (1.532)	1.87 (0.533)	2.25 (0.444)	2.38 (0.421)	2.49 (0.402)
	Exterior Finish				
	13 mm stucco	aluminum or vinyl siding	wood siding	100 mm brick and 25 mm air	
RSI Adjustment	0.01	0.11	0.15	0.25	
	Sheathing <sup>(4)</sup>				
	RSI 0.88	RSI 1.05	RSI 1.14	RSI 1.33	RSI 1.42
RSI Adjustment	0.88	1.05	1.14	1.33	1.42
	Interior Finish				
	6 mm wood paneling	16 mm gypsum board	strapped air space		
RSI Adjustment	-0.02	0.02	0.19		

**Table B-14 (Continued)**

Example: normal weight blocks, 38 x 64 mm @ 406 mm o.c. with RSI 2.29 total insulation

$$\begin{aligned}
 RSI_F &= \text{Exterior Air} + \text{Concrete Block} + 64 \text{ mm Wood} + \text{Insulation (between concrete and frame)} \\
 &\quad + 13 \text{ mm Gypsum} + \text{Interior Air} \\
 &= 0.03 + 0.21 + 0.5184 + (2.29 - (2.29 \div 89 \times 64)) + 0.0793 + 0.12 \\
 &= 1.6010 \\
 RSI_I &= \text{Exterior Air} + \text{Concrete Block} + \text{Insulation} + 13 \text{ mm Gypsum} + \text{Interior Air} \\
 &= 0.03 + 0.21 + 2.29 + 0.0793 + 0.12 \\
 &= 2.7293 \\
 RSI_T &= 1 \div ((0.19 \div RSI_F) + (0.81 \div RSI_I)) \\
 &= 2.41
 \end{aligned}$$

**Notes to Table B-14:**

- (1) To convert insulation RSI to insulation thickness, see Table B-1.
- (2) The batts are not compressed; the studs are pulled away from the concrete to accommodate batt thickness.
- (3) The effective thermal resistance and overall thermal transmittance values given have been calculated using framing percentages listed in Table C-1 of Appendix C.
- (4) For other insulated sheathings, add the sheathing RSI to total RSI.

## Appendix B

**Table B-15**  
**Masonry Wall: 190 mm Concrete Block (Normal Weight) with/without Metal Framing**  
 with no exterior finish and 13 mm gypsum board interior finish

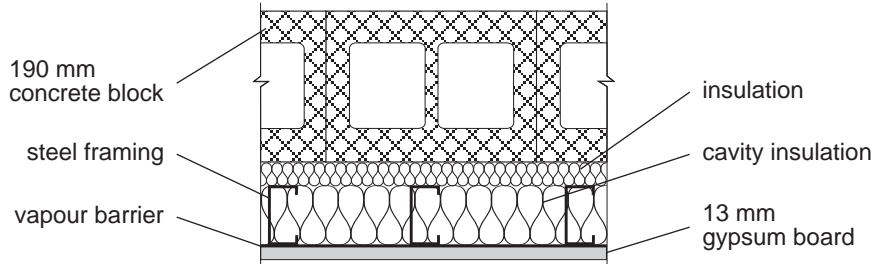

Framing/Spacing	Total Insulation <sup>(1)(2)</sup>				
	no insulation	RSI 1.41	RSI 2.11	RSI 2.29	RSI 2.46
	Effective RSI (Overall U-Value) <sup>(3)</sup>				
no framing	0.44 (2.276)	-	-	-	-
41 x 92 mm @ 406 mm o.c.	0.57 (1.764)	1.09 (0.918)	1.26 (0.795)	1.31 (0.761)	1.37 (0.731)
41 x 92 mm @ 610 mm o.c.	0.59 (1.691)	1.38 (0.724)	1.64 (0.609)	1.73 (0.578)	1.81 (0.551)
Exterior Finish					
	13 mm stucco	aluminum or vinyl siding	wood siding	100 mm brick and 25 mm air	
RSI Adjustment	0.01	0.11	0.15	0.25	
Sheathing <sup>(4)</sup>					
	RSI 0.88	RSI 1.05	RSI 1.14	RSI 1.33	RSI 1.42
RSI Adjustment	0.88	1.05	1.14	1.33	1.42
Interior Finish					
	6 mm wood paneling	16 mm gypsum board	strapped air space		
RSI Adjustment	-0.02	0.02	0.19		

**Table B-15 (Continued)**

<p>Example: normal weight blocks, 41 x 92 mm @ 406 mm o.c. with RSI 2.29 insulation</p> $\begin{aligned} RSI_F &= \text{Exterior Air} + \text{Concrete Block} + 92 \text{ mm Steel Framing} + 13 \text{ mm Gypsum} + \text{Interior Air} \\ &= 0.03 + 0.21 + 0.0014812 + 0.0793 + 0.12 \\ &= 0.4408 \end{aligned}$ $\begin{aligned} RSI_I &= \text{Exterior Air} + \text{Concrete Block} + \text{Insulation} + 13 \text{ mm Gypsum} + \text{Interior Air} \\ &= 0.03 + 0.21 + 2.29 + 0.0793 + 0.12 \\ &= 2.7293 \end{aligned}$ $\begin{aligned} RSI_{T1} &= 1 \div ((0.0063 \div RSI_F) + (0.9937 \div RSI_I)) \\ &= 2.6422 \end{aligned}$ $\begin{aligned} RSI_{T2} &= 1 \div ((0.0063 \div \text{RSI of Steel Framing}) + (0.9937 \div \text{RSI of Insulation})) \\ &= 1 \div ((0.0063 \div 0.0014812) + (0.9937 \div 2.29)) \\ &= 0.2133 \end{aligned}$ $\begin{aligned} RSI_{T3} &= RSI_{T2} + \text{Exterior Air} + \text{Concrete Block} + 13 \text{ mm Gypsum} + \text{Interior Air} \\ &= 0.2133 + 0.03 + 0.21 + 0.0793 + 0.12 \\ &= 0.6526 \end{aligned}$ $\begin{aligned} RSI_T &= (RSI_{T1} + (2 \times RSI_{T3})) \div 3 \\ &= 1.31 \end{aligned}$
---

**Notes to Table B-15:**

- (1) To convert insulation RSI to insulation thickness, see Table B-1.
- (2) The batts are not compressed; the studs are pulled away from the concrete to accommodate batt thickness.
- (3) The effective thermal resistance and overall thermal transmittance values given have been calculated using framing percentages listed in Table C-1 of Appendix C.
- (4) For other insulated sheathings, add the sheathing RSI to total RSI.

## Appendix B

**Table B-16**  
**Sheet Steel Wall: Z-Girt @ 1830 mm o.c.**  
 with 0.7 mm corrugated sheet steel exterior and 0.7 mm V-rib sheet steel interior

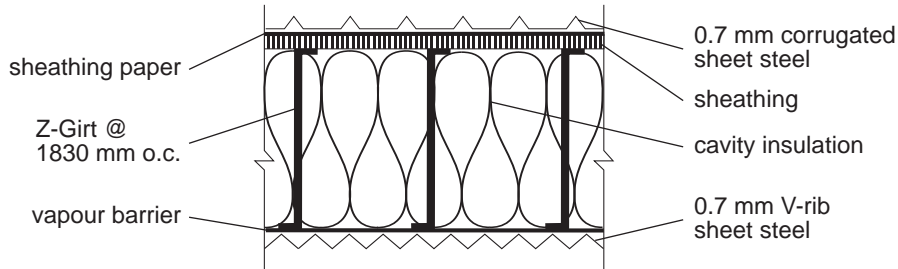

Z-Girt width	Cavity Insulation <sup>(1)</sup>				
	no insulation	RSI 2.11	RSI 2.46	RSI 3.52	RSI 3.70
	Effective RSI (Overall U-Value), No Sheathing <sup>(2)</sup>				
89 x 1.5 mm Z-Girt	0.32 (3.110)	1.67 (0.599)	1.87 (0.534)	2.46 (0.407)	2.56 (0.391)
140 x 1.5 mm Z-Girt	0.32 (3.083)	1.79 (0.559)	2.01 (0.497)	2.65 (0.378)	2.75 (0.363)
RSI Adjustment	Sheathing <sup>(3)</sup>				
	RSI 0.88	RSI 1.05	RSI 1.14	RSI 1.33	RSI 1.42
<p>Example: 89 x 1.5 mm Z-Girt, no sheathing, with RSI 3.52 cavity insulation, using sprayed polyurethane foam</p> $RSI_F = \text{Exterior Air} + \text{Sheet Steel} + 89 \text{ mm Z-Girt} + \text{Sheet Steel} + \text{Interior Air}$ $= 0.03 + 0.00001127 + 0.0014329 + 0.00001127 + 0.12$ $= 0.1515$ $RSI_I = \text{Exterior Air} + \text{Sheet Steel} + \text{Insulation} + \text{Sheet Steel} + \text{Interior Air-Walls}$ $= 0.03 + 0.00001127 + 3.52 + 0.00001127 + 0.12$ $= 3.6700$ $RSI_{T1} = 1 \div ((0.0008 \div RSI_F) + (0.9992 \div RSI_I))$ $= 3.6014$ $RSI_{T2} = 1 \div ((0.0008 \div \text{RSI of Steel Framing}) + (0.9992 \div \text{RSI of Insulation}))$ $= 1.1684$ $RSI_{T3} = RSI_{T2} + \text{Exterior Air} + \text{Sheet Steel} + \text{Sheet Steel} + \text{Interior Air}$ $= 1.1684 + 0.03 + 0.00001127 + 0.00001127 + 0.12$ $= 1.3184$ $RSI_T = (RSI_{T1} + RSI_{T3}) \div 2$ $= 2.46$ <p>Note: The 1/2 - 1/2 coefficients can be used for Z-girt spacings 1200 mm or greater; otherwise, use 1/3 - 2/3.</p>					

### Notes to Table B-16:

- (1) To convert insulation RSI to insulation thickness, see Table B-1.
- (2) The effective thermal resistance and overall thermal transmittance values given have been calculated using framing percentages listed in Table C-1 of Appendix C.
- (3) For other insulated sheathings, add the sheathing RSI to total RSI.

**Table B-17**  
**Sheet Steel Wall: Z-Girt @ 2440 mm o.c.**  
 with 0.7 mm corrugated sheet steel exterior and 0.7 mm V-rib sheet steel interior

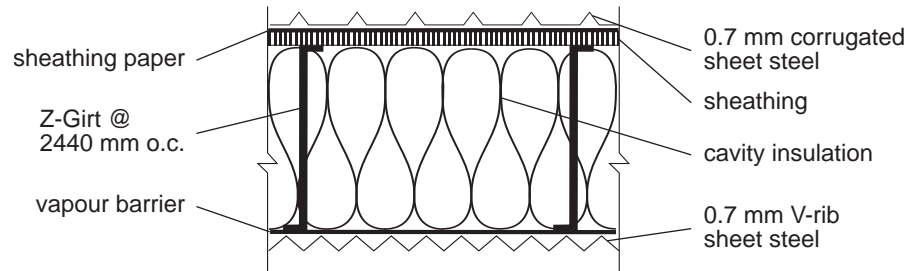

Z-Girt width	Cavity Insulation <sup>(1)</sup>				
	no insulation	RSI 2.11	RSI 2.46	RSI 3.52	RSI 3.7
	Effective RSI (Overall U-Value), No Sheathing <sup>(2)</sup>				
89 x 1.5 mm Z-Girt	0.32 (3.091)	1.75 (0.572)	1.97 (0.509)	2.59 (0.387)	2.69 (0.372)
140 x 1.5 mm Z-Girt	0.33 (3.070)	1.87 (0.536)	2.10 (0.475)	2.78 (0.359)	2.89 (0.346)
	Sheathing <sup>(3)</sup>				
	RSI 0.88	RSI 1.05	RSI 1.14	RSI 1.33	RSI 1.42
RSI Adjustment	0.88	1.05	1.14	1.33	1.42
<p>Example: 89 x 1.5 mm Z-Girt, no sheathing, with RSI 3.52 cavity insulation, using sprayed polyurethane foam</p> $RSI_F = \text{Exterior Air} + \text{Sheet Steel} + 89 \text{ mm Z-Girt} + \text{Sheet Steel} + \text{Interior Air}$ $= 0.03 + 0.00001127 + 0.0014329 + 0.00001127 + 0.12$ $= 0.1515$ $RSI_I = \text{Exterior Air} + \text{Sheet Steel} + \text{Insulation} + \text{Sheet Steel} + \text{Interior Air}$ $= 0.03 + 0.00001127 + 3.52 + 0.00001127 + 0.12$ $= 3.6700$ $RSI_{T1} = 1 \div ((0.0006 \div RSI_F) + (0.9994 \div RSI_I))$ $= 3.6183$ $RSI_{T2} = 1 \div ((0.0006 \div \text{RSI of Steel Framing}) + (0.9994 \div \text{RSI of Insulation}))$ $= 1.4026$ $RSI_{T3} = RSI_{T2} + \text{Exterior Air} + \text{Sheet Steel} + \text{Sheet Steel} + \text{Interior Air}$ $= 1.4026 + 0.03 + 0.00001127 + 0.00001127 + 0.12$ $= 1.5526$ $RSI_T = (RSI_{T1} + RSI_{T3}) \div 2$ $= 2.59$ <p>Note: The 1/2 - 1/2 coefficients can be used for Z-girt spacings 1200 mm or greater; otherwise, use 1/3 - 2/3.</p>					

**Notes to Table B-17:**

- (1) To convert insulation RSI to insulation thickness, see Table B-1.
- (2) The effective thermal resistance and overall thermal transmittance values given have been calculated using framing percentages listed in Table C-1 of Appendix C.
- (3) For other insulating sheathings, add the sheathing RSI value to total RSI.

## Appendix B

**Table B-18**  
**Floor: Truss- or Wood I-Joist-Type @ 406 mm o.c.**  
 Trusses or I-Joists with no exterior finish and carpet and fibrous pad interior finish

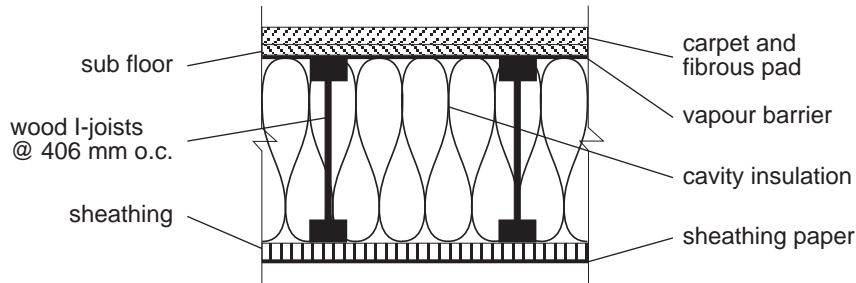

Sheathing <sup>(2)</sup>	Cavity Insulation <sup>(1)</sup>			
	RSI 5.46	RSI 7.04	RSI 8.81	RSI 10.6
	Effective RSI (Overall U-Value) <sup>(3)</sup>			
no sheathing	5.85 (0.171)	7.32 (0.137)	9.07 (0.110)	10.73 (0.093)
13 mm gypsum	5.93 (0.169)	7.40 (0.135)	9.16 (0.109)	10.81 (0.092)
11 mm plywood or particle board	5.95 (0.168)	7.42 (0.135)	9.17 (0.109)	10.83 (0.092)
11 mm waferboard or OSB	5.97 (0.167)	7.44 (0.134)	9.20 (0.109)	10.86 (0.092)
11 mm fibreboard	6.03 (0.166)	7.51 (0.133)	9.26 (0.108)	10.92 (0.092)
RSI 0.88 sheathing	6.76 (0.148)	8.24 (0.121)	9.99 (0.100)	11.66 (0.086)
RSI 0.97 sheathing	6.85 (0.146)	8.33 (0.120)	10.09 (0.099)	11.75 (0.085)
RSI 1.05 sheathing	6.93 (0.144)	8.42 (0.119)	10.17 (0.098)	11.84 (0.084)
RSI 1.14 sheathing	7.02 (0.142)	8.51 (0.118)	10.26 (0.097)	11.93 (0.084)
	Exterior Finish			
	3 mm plywood	6 mm plywood		
RSI Adjustment	0.03	0.05		
	Interior Finish <sup>(4)</sup>			
	ceramic tile	linoleum, vinyl, rubber or terrazzo tile	hardwood finish	carpet and rubber pad
RSI Adjustment	-0.37	-0.36	-0.25	-0.15

**Table B-18 (Continued)**

Example:	with wood I-Joists, RSI 0.88 sheathing with RSI 7.04 cavity insulation
$RSI_{Fweb}$	$= \text{Exterior Air} + \text{Sheathing Paper} + \text{Sheathing} + \text{Wood Web} + 16 \text{ mm Plywood} + \text{Carpet and Pad} + \text{Interior Air}$ $= 0.03 + 0.011 + 0.88 + (265 \times 0.0081) + 0.1392 + 0.37 + 0.16$ $= 3.7367$
$RSI_{Fflange}$	$= \text{Exterior Air} + \text{Sheathing Paper} + \text{Sheathing} + 2 \times 38 \text{ mm Wood Flanges} + \text{Insulation} + 16 \text{ mm Plywood} + \text{Carpet and Pad} + \text{Interior Air}$ $= 0.03 + 0.011 + 0.88 + (2 \times 0.3078) + (7.04 - 2 \times 38 \times (7.04 \div 265)) + 0.1392 + 0.37 + 0.16$ $= 7.2268$
$RSI_i$	$= \text{Exterior Air} + \text{Sheathing Paper} + \text{Sheathing} + \text{Insulation} + 16 \text{ mm Plywood} + \text{Carpet and Pad} + \text{Interior Air}$ $= 0.03 + 0.011 + 0.88 + 7.04 + 0.1392 + 0.37 + 0.16$ $= 8.6302$
	Assuming that the thickness of the I-Joist web is 25% of the width of the flanges:
$RSI_T$	$= 1 \div (((0.25 \times 0.1) \div RSI_{Fweb}) + ((0.75 \times 0.1) \div RSI_{Fflange}) + (0.9 \div RSI_i))$ $= 8.24$

**Notes to Table B-18:**

- (1) To convert insulation RSI to insulation thickness, see Table B-1.
- (2) For other insulating sheathings, add the sheathing RSI value to the 'no sheathing' category.
- (3) The effective thermal resistance and overall thermal transmittance values given have been calculated using framing percentages listed in Table C-1 of Appendix C.
- (4) Interior finish includes subfloor.

## Appendix B

**Table B-19**  
**Floor: Truss- or Wood I-Joist-Type @ 610 mm o.c.**  
 Trusses or I-Joists with no exterior finish and carpet and fibrous pad interior finish

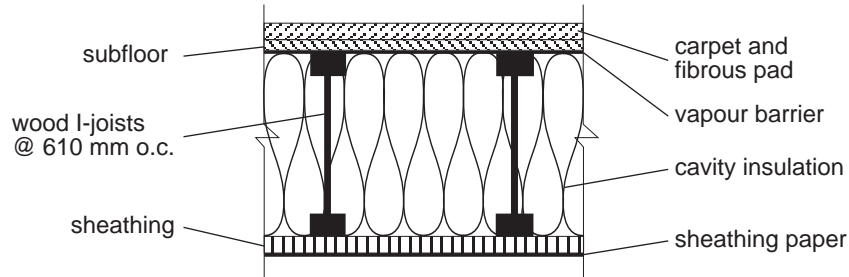

Sheathing <sup>(2)</sup>	Cavity Insulation <sup>(1)</sup>			
	RSI 5.46	RSI 7.04	RSI 8.81	RSI 10.6
	Effective RSI (Overall U-Value) <sup>(3)</sup>			
no sheathing	5.94 (0.168)	7.44 (0.134)	9.20 (0.109)	10.90 (0.092)
13 mm gypsum	6.02 (0.166)	7.52 (0.133)	9.29 (0.108)	10.98 (0.091)
11 mm plywood or particle board	6.04 (0.166)	7.54 (0.133)	9.30 (0.107)	11.00 (0.091)
11 mm waferboard or OSB	6.06 (0.165)	7.57 (0.132)	9.33 (0.107)	11.02 (0.091)
11 mm fibreboard	6.13 (0.163)	7.63 (0.131)	9.39 (0.106)	11.09 (0.090)
RSI 0.88 sheathing	6.84 (0.146)	8.35 (0.120)	10.11 (0.099)	11.81 (0.085)
RSI 0.97 sheathing	6.93 (0.144)	8.45 (0.118)	10.20 (0.098)	11.91 (0.084)
RSI 1.05 sheathing	7.02 (0.143)	8.53 (0.117)	10.29 (0.097)	11.99 (0.083)
RSI 1.14 sheathing	7.11 (0.141)	8.62 (0.116)	10.38 (0.096)	12.08 (0.083)
	Exterior Finish			
	3 mm plywood	6 mm plywood		
RSI Adjustment	0.03	0.05		
	Interior Finish <sup>(4)</sup>			
	ceramic tile	linoleum, vinyl, rubber or terrazzo tile	hardwood finish	carpet and rubber pad
RSI Adjustment	-0.37	-0.36	-0.25	-0.15

**Table B-19 (Continued)**

Example:	with wood I-Joists, RSI 0.88 sheathing with RSI 7.04 cavity insulation
$RSI_{Fweb}$	$= \text{Exterior Air} + \text{Sheathing Paper} + \text{Sheathing} + \text{Wood Web} + 16 \text{ mm Plywood} + \text{Carpet and Pad} + \text{Interior Air}$ $= 0.03 + 0.011 + 0.88 + (265 \times 0.0081) + 0.1392 + 0.37 + 0.16$ $= 3.7367$
$RSI_{Fflange}$	$= \text{Exterior Air} + \text{Sheathing Paper} + \text{Sheathing} + 2 \times 38 \text{ mm Wood Flanges} + \text{Insulation} + 16 \text{ mm Plywood} + \text{Carpet and Pad} + \text{Interior Air}$ $= 0.03 + 0.011 + 0.88 + (2 \times 0.3078) + (7.04 - 2 \times 38 \times (7.04 \div 265)) + 0.1392 + 0.37 + 0.16$ $= 7.2268$
$RSI_i$	$= \text{Exterior Air} + \text{Sheathing Paper} + \text{Sheathing} + \text{Insulation} + 16 \text{ mm Plywood} + \text{Carpet and Pad} + \text{Interior Air}$ $= 0.03 + 0.011 + 0.88 + 7.04 + 0.1392 + 0.37 + 0.16$ $= 8.6302$
	Assuming that the thickness of the I-Joist web is 25% of the width of the flanges:
$RSI_T$	$= 1 \div (((0.25 \times 0.07) \div RSI_{Fweb}) + ((0.75 \times 0.07) \div RSI_{Fflange}) + (0.93 \div RSI_i))$ $= 8.35$

**Notes to Table B-19:**

- (1) To convert insulation RSI to insulation thickness, see Table B-1.
- (2) For other insulating sheathings, add the sheathing RSI value to the 'no sheathing' category.
- (3) The effective thermal resistance and overall thermal transmittance values given have been calculated using framing percentages listed in Table C-1 of Appendix C.
- (4) Interior finish includes subfloor.

## Appendix B

**Table B-20**  
**Floor: Floor-Joist-Type**

Joist @ 406 mm o.c. with no exterior finish and carpet and fibrous pad interior finish

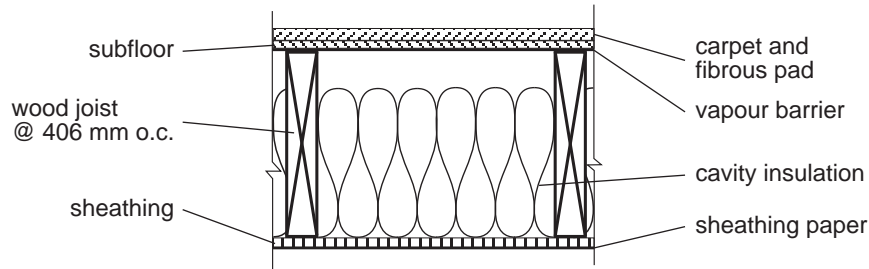

Sheathing <sup>(3)</sup>	Cavity Insulation <sup>(1)(2)</sup>				
	RSI 2.46	RSI 3.52	RSI 4.93	RSI 5.46	RSI 7.04
	Effective RSI (Overall U-Value) <sup>(4)</sup>				
no sheathing	3.23 (0.310)	4.04 (0.247)	5.22 (0.192)	5.58 (0.179)	6.85 (0.146)
13 mm gypsum	3.31 (0.302)	4.13 (0.242)	5.30 (0.189)	5.67 (0.176)	6.94 (0.144)
11 mm plywood or particle board	3.33 (0.301)	4.14 (0.241)	5.32 (0.188)	5.69 (0.176)	6.96 (0.144)
11 mm waferboard or OSB	3.35 (0.298)	4.17 (0.240)	5.35 (0.187)	5.71 (0.175)	6.99 (0.143)
11 mm fibreboard	3.41 (0.293)	4.23 (0.236)	5.42 (0.185)	5.78 (0.173)	7.06 (0.142)
RSI 0.88 sheathing	4.12 (0.243)	4.97 (0.201)	6.17 (0.162)	6.55 (0.153)	7.85 (0.127)
RSI 1.05 sheathing	4.29 (0.233)	5.14 (0.194)	6.35 (0.158)	6.73 (0.149)	8.03 (0.124)
RSI 1.14 sheathing	4.38 (0.228)	5.24 (0.191)	6.44 (0.155)	6.83 (0.146)	8.13 (0.123)
RSI 1.32 sheathing	4.57 (0.219)	5.42 (0.184)	6.63 (0.151)	7.02 (0.142)	8.33 (0.120)
	Joists @ 610 mm o.c. <sup>(5)</sup>				
	RSI 2.46	RSI 3.52	RSI 4.93	RSI 5.46	RSI 7.04
RSI Adjustment	0.05	0.10	0.16	0.20	0.28
	Exterior Finish				
	3 mm plywood	6 mm plywood			
RSI Adjustment	0.03	0.05			
	Interior Finish <sup>(6)</sup>				
	ceramic tile	linoleum, vinyl, rubber or terrazzo tile	hardwood finish	carpet and rubber pad	
RSI Adjustment	-0.37	-0.36	-0.25	-0.15	

**Table B-20 (Continued)**

<p>Example: RSI 0.88 sheathing with RSI 3.52 cavity insulation</p> $RSI_F = \text{Exterior Air} + \text{Sheathing Paper} + \text{Sheathing} + 191 \text{ mm Wood} + 16 \text{ mm Plywood} + \text{Carpet and Pad} + \text{Interior Air}$ $= 0.03 + 0.011 + 0.88 + (191 \times 0.0081) + 0.1392 + 0.37 + 0.16$ $= 3.1373$ $RSI_I = \text{Exterior Air} + \text{Sheathing Paper} + \text{Sheathing} + \text{Insulation} + 40 \text{ mm Air Space} + 16 \text{ mm Plywood} + \text{Carpet and Pad} + \text{Interior Air}$ $= 0.03 + 0.011 + 0.88 + 3.52 + 0.20 + 0.1392 + 0.37 + 0.16$ $= 5.3102$ $RSI_T = 1 \div ((0.1 \div RSI_F) + (0.9 \div RSI_I))$ $= 4.97$
--

**Notes to Table B-20:**

- (1) To convert insulation RSI to insulation thickness, see Table B-1.
- (2) Glass/mineral fibre batts used to determine insulation thickness.
- (3) For other insulating sheathings, add the sheathing RSI value to the 'no sheathing' category.
- (4) The effective thermal resistance and overall thermal transmittance values given have been calculated using framing percentages listed in Table C-1 of Appendix C.
- (5) Joist sizes used:
  - 38 x 191 mm for RSI 2.46 and RSI 3.52
  - 38 x 241 mm for RSI 4.93 and RSI 5.46
  - 38 x 292 mm for RSI 7.04
- (6) Interior finish includes subfloor.

## Appendix B

**Table B-21**  
**Floor: Concrete**  
 with no exterior or interior finish

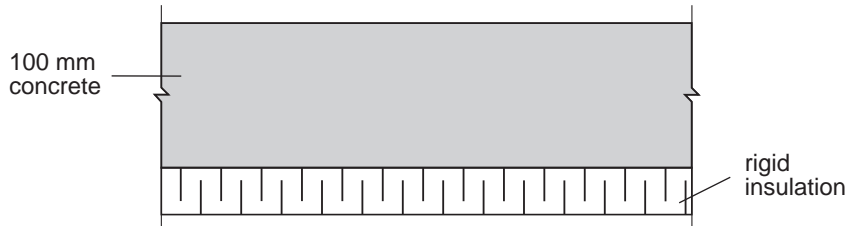

Depth	Rigid Insulation <sup>(1)</sup>						
	no insulation	RSI 0.88	RSI 1.32	RSI 1.76	RSI 2.64	RSI 3.52	RSI 4.42
	Effective RSI (Overall U-Value)						
100 mm	0.23 (4.348)	1.11 (0.901)	1.55 (0.645)	1.99 (0.503)	2.87 (0.348)	3.75 (0.267)	4.65 (0.215)
RSI Adjustment	Interior Finish <sup>(2)</sup>						
	ceramic tile	linoleum, vinyl, rubber or terrazzo tile	hardwood finish	carpet and rubber pad	carpet and fibrous pad		
	0.14	0.15	0.26	0.36	0.51		
<p>Example: RSI 0.88 rigid insulation</p> $RSI_T = \text{Interior Air} + 100 \text{ mm Concrete} + \text{Insulation} + \text{Exterior Air}$ $= 0.16 + 0.04 + 0.88 + 0.03$ $= 1.11$							

**Notes to Table B-21:**

- (1) To convert insulation RSI to insulation thickness, see Table B-1.
- (2) Interior finish includes subfloor.

**Table B-22**  
**Walls in Contact with the Ground: 200 mm Concrete with/without Wood Framing**  
 with 13 mm gypsum board interior finish

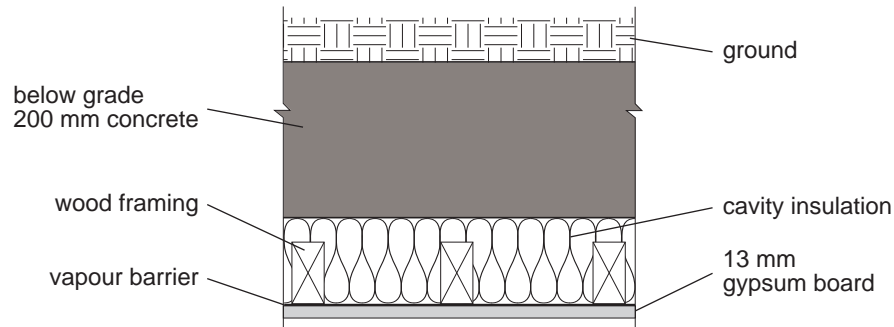

Framing/Spacing	Cavity Insulation <sup>(1)(2)</sup>					
	no insulation	RSI 1.41	RSI 2.11	RSI 2.29	RSI 2.46	RSI 3.52
	Effective RSI (Overall U-Value) <sup>(3)</sup>					
no framing (no gypsum board)	0.21 (4.739)	-	-	-	-	-
38 x 64 mm @ 406 mm o.c.	0.51 (1.975)	1.43 (0.698)	1.93 (0.518)	2.03 (0.494)	2.11 (0.474)	2.57 (0.390)
38 x 64 mm @ 610 mm o.c.	0.49 (2.037)	1.53 (0.653)	2.10 (0.476)	2.22 (0.450)	2.33 (0.428)	2.96 (0.337)
38 x 89 mm @ 406 mm o.c.	0.52 (1.933)	1.64 (0.610)	1.95 (0.514)	2.04 (0.490)	2.13 (0.470)	2.77 (0.361)
38 x 89 mm @ 610 mm o.c.	0.50 (2.013)	1.73 (0.578)	2.11 (0.474)	2.23 (0.448)	2.35 (0.426)	3.12 (0.320)
	Interior or Exterior Rigid Insulation <sup>(4)</sup>					
	RSI 0.88	RSI 1.05	RSI 1.42	RSI 1.76	RSI 2.13	RSI 2.84
RSI Adjustment	0.88	1.05	1.42	1.76	2.13	2.84
	Interior Finish					
	6 mm wood paneling	16 mm gypsum board	strapped air space			
RSI Adjustment	-0.02	0.02	0.19			

## Appendix B

Table B-22 (Continued)

Example: 38 x 64 mm @ 406 mm o.c. with RSI 2.29 cavity insulation

$$RSI_F = 200 \text{ mm Concrete} + \text{Sheathing Paper} + \text{Air Gap Behind Framing} + 64 \text{ mm Wood} + 13 \text{ mm Gypsum} + \text{Interior Air}$$

$$= 0.08 + 0.011 + 0.18 + 0.5184 + 0.0793 + 0.12$$
$$= 0.9887$$

$$RSI_I = 200 \text{ mm Concrete} + \text{Sheathing Paper} + \text{Insulation} + 13 \text{ mm Gypsum} + \text{Interior Air}$$

$$= 0.08 + 0.011 + 2.29 + 0.0793 + 0.12$$
$$= 2.5803$$

$$RSI_T = 1 \div ((0.17 \div RSI_F) + (0.83 \div RSI_I))$$

$$= 2.03$$

### Notes to Table B-22:

- (1) To convert insulation RSI to insulation thickness, see Table B-1.
- (2) The batts are not compressed; the studs are pulled away from the concrete to accommodate batt thickness.
- (3) The effective thermal resistance and overall thermal transmittance values given have been calculated using framing percentages listed in Table C-1 of Appendix C.
- (4) For other insulating sheathings, add the sheathing RSI value to total RSI.

**Table B-23**  
**Walls in Contact with the Ground: 200 mm Concrete with/without Steel Framing**  
 with 13 mm gypsum board interior finish

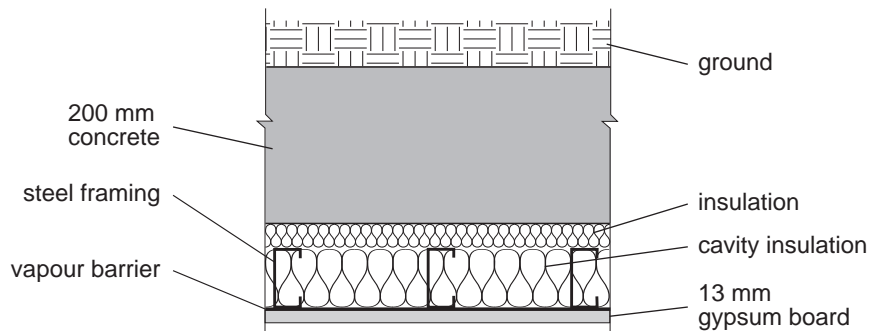

Framing/Spacing	Cavity Insulation <sup>(1)(2)</sup>					
	no insulation	RSI 1.41	RSI 2.11	RSI 2.29	RSI 2.46	RSI 3.50
	Effective RSI (Overall U-Value) <sup>(3)</sup>					
no framing (no gypsum board)	0.21 (4.739)	-	-	-	-	-
41 x 92 mm @ 406 mm o.c.	0.42 (2.375)	0.95 (1.052)	1.12 (0.895)	1.17 (0.852)	1.23 (0.816)	1.54 (0.650)
41 x 92 mm @ 610 mm o.c.	0.44 (2.252)	1.24 (0.805)	1.50 (0.667)	1.59 (0.630)	1.67 (0.599)	2.16 (0.462)
	Interior or Exterior Rigid Insulation <sup>(4)</sup>					
	RSI 0.88	RSI 1.05	RSI 1.42	RSI 1.76	RSI 2.13	RSI 2.84
RSI Adjustment	0.88	1.05	1.42	1.76	2.13	2.84
	Interior Finish					
	6 mm wood paneling	16 mm gypsum board	strapped air space			
RSI Adjustment	-0.02	0.02	0.19			

## Appendix B

Table B-23 (Continued)

Example: 41 x 92 mm @ 406 mm o.c. with RSI 2.29 cavity insulation

$$\begin{aligned} \text{RSI}_F &= 200 \text{ mm Concrete} + \text{Sheathing Paper} + 92 \text{ mm Steel Framing} + 13 \text{ mm Gypsum} + \text{Interior Air} \\ &= 0.08 + 0.011 + 0.0014812 + 0.0793 + 0.12 \\ &= 0.2918 \end{aligned}$$

$$\begin{aligned} \text{RSI}_I &= 200 \text{ mm Concrete} + \text{Sheathing Paper} + \text{Insulation} + 13 \text{ mm Gypsum} + \text{Interior Air} \\ &= 0.08 + 0.011 + 2.29 + 0.0793 + 0.12 \\ &= 2.5803 \end{aligned}$$

$$\begin{aligned} \text{RSI}_{T1} &= 1 \div ((0.0057 \div \text{RSI}_F) + (0.9943 \div \text{RSI}_I)) \\ &= 2.4702 \end{aligned}$$

$$\begin{aligned} \text{RSI}_{T2} &= 1 \div ((0.0057 \div \text{RSI of Steel Framing}) + (0.9943 \div \text{RSI of Insulation})) \\ &= 1 \div ((0.0057 \div 0.0014812) + (0.9943 \div 2.29)) \\ &= 0.2342 \end{aligned}$$

$$\begin{aligned} \text{RSI}_{T3} &= \text{RSI}_{T2} + 200 \text{ mm Concrete} + \text{Sheathing Paper} + 13 \text{ mm Gypsum} + \text{Interior Air} \\ &= 0.2342 + 0.08 + 0.011 + 0.0793 + 0.12 \\ &= 0.5245 \end{aligned}$$

$$\begin{aligned} \text{RSI}_T &= (\text{RSI}_{T1} + (2 \times \text{RSI}_{T3})) \div 3 \\ &= 1.17 \end{aligned}$$

### Notes to Table B-23:

- (1) To convert insulation RSI to insulation thickness, see Table B-1.
- (2) The batts are not compressed; the studs are pulled away from the concrete to accommodate batt thickness.
- (3) The effective thermal resistance and overall thermal transmittance values given have been calculated using framing percentages listed in Table C-1 of Appendix C.
- (4) For other insulating sheathings, add the sheathing RSI value to total RSI.

**Table B-24**  
**Walls in Contact with the Ground: Preserved Wood Foundation Wall**  
 with 16 mm plywood exterior finish and 13 mm gypsum board interior finish

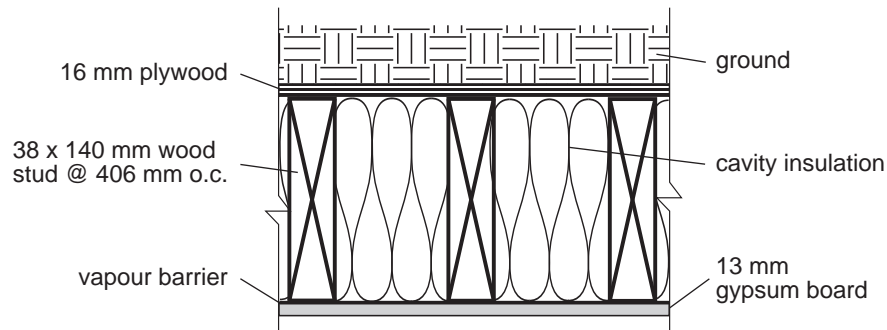

Framing/Spacing	Cavity Insulation <sup>(1)</sup>				
	no insulation	RSI 3.25	RSI 3.52	RSI 3.87	RSI 5.9
	Effective RSI (Overall U-Value) <sup>(2)</sup>				
38 x 140 mm @ 406 mm o.c.	0.58 (1.716)	2.88 (0.347)	3.03 (0.331)	3.20 (0.313)	4.02 (0.248)
38 x 140 mm @ 610 mm o.c.	0.55 (1.804)	3.14 (0.319)	3.32 (0.301)	3.55 (0.282)	4.71 (0.212)
	Exterior Insulation <sup>(3)</sup>				
	RSI 0.88	RSI 0.97	RSI 1.05	RSI 1.14	RSI 1.42
RSI Adjustment	0.88	0.97	1.05	1.14	1.42
	Interior Finish				
	6 mm wood paneling	16 mm gypsum board	strapped air space		
RSI Adjustment	-0.02	0.02	0.19		
<p>Example: 38 x 140 mm @ 406 mm o.c. with RSI 3.52 cavity insulation</p> $RSI_F = 16 \text{ mm Plywood} + 140 \text{ mm Wood} + 13 \text{ mm Gypsum} + \text{Interior Air}$ $= 0.1392 + 1.134 + 0.0793 + 0.12$ $= 1.4725$ $RSI_I = 16 \text{ mm Plywood} + \text{Insulation} + 13 \text{ mm Gypsum} + \text{Interior Air}$ $= 0.1392 + 3.52 + 0.0793 + 0.12$ $= 3.8585$ $RSI_T = 1 \div ((0.17 \div RSI_F) + (0.83 \div RSI_I))$ $= 3.03$					

**Notes to Table B-24:**

- (1) To convert insulation RSI to insulation thickness, see Table B-1.
- (2) The effective thermal resistance and overall thermal transmittance values given have been calculated using framing percentages listed in Table C-1 of Appendix C.
- (3) For other insulating sheathings, add the sheathing RSI value to total RSI.

## Appendix B

**Table B-25**  
**Floors in Contact with the Ground: Concrete**  
 with no interior finish

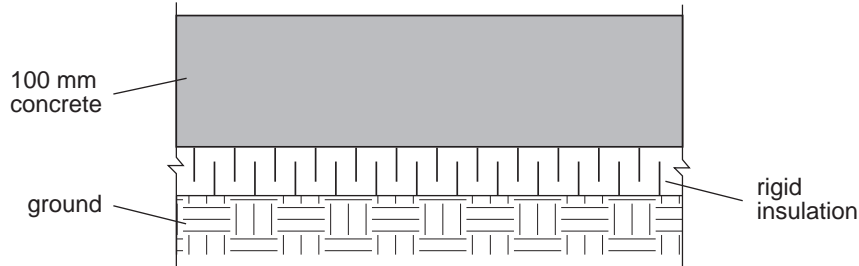

Framing/Spacing	Rigid Insulation <sup>(1)</sup>						
	no insulation	RSI 0.88	RSI 1.32	RSI 1.76	RSI 2.64	RSI 3.52	RSI 4.42
	Effective RSI (Overall U-Value)						
Slab Thickness: 100 mm	0.20 (5.000)	1.08 (0.926)	1.52 (0.658)	1.96 (0.510)	2.84 (0.352)	3.72 (0.269)	4.62 (0.216)
RSI Adjustment	Interior Finish <sup>(2)</sup>						
	ceramic tile	linoleum, vinyl, rubber or terrazzo tile	hardwood finish	carpet and rubber pad	carpet and fibrous pad		
	0.14	0.15	0.26	0.36	0.51		
Example: RSI 0.88 rigid insulation  $RSI_T = 100 \text{ mm Concrete} + \text{Insulation} + \text{Interior Air}$ $= 0.04 + 0.88 + 0.16$ $= 1.08$							

**Notes to Table B-25:**

- (1) To convert insulation RSI to insulation thickness, see Table B-1.
- (2) Interior finish includes subfloor.

---

# Appendix C

## Method for Calculating the Thermal Properties of Building Assemblies

### Assemblies With Wood Framing

Where the overall thermal transmittance of a building envelope assembly containing wood framing cannot be determined from the tables in Appendix B, the procedure described herein shall be used.

This procedure is described in the ASHRAE Handbook of Fundamentals<sup>1</sup> for parallel path heat flow. It involves first calculating two sums of the thermal resistances of the various materials incorporated in the assembly —

- along a line that goes through the framing,  $RSI_F$ , and
- along a line that goes through the insulated portion,  $RSI_I$ .

The two sums are then combined, in proportion to the relative areas of framing and insulation, to calculate an effective thermal resistance,  $RSI_T$ , using the following formula:

$$RSI_T = \frac{100}{\frac{\% \text{ area with framing}}{RSI_F} + \frac{\% \text{ area w/o framing}}{RSI_I}}$$

Finally, the reciprocal of the effective thermal resistance is calculated to yield the overall thermal transmittance. Typical percentages of areas with and without framing are obtained from Table C-1 at the end of this appendix. RSI values for various materials are obtained from Table C-2.

---

<sup>1</sup> Calculating Overall Thermal Resistances, page 24.2 of the 1997 ASHRAE Handbook

## Appendix C

Example 1: Wood Frame Wall

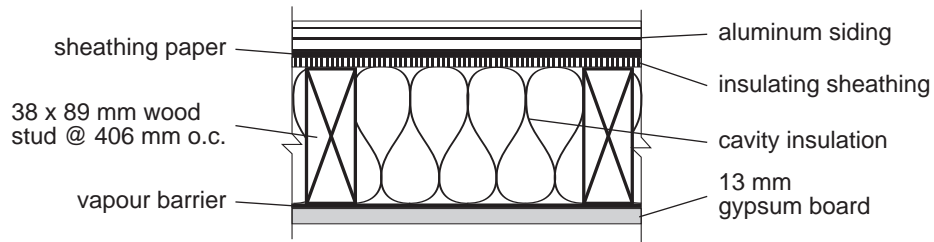

38 x 89 mm wood studs @ 406 mm o.c., RSI 2.11 batts, RSI 1.14 semi-rigid insulation		
Components	RSI <sub>F</sub> through stud, m <sup>2</sup> ·°C/W	RSI <sub>I</sub> through insulation, m <sup>2</sup> ·°C/W
Outside air film	0.03	0.03
Metal siding	0.11	0.11
Sheathing paper	0.01	0.01
Semi-rigid glass fibre (38 mm × 0.03 RSI/mm)	1.14	1.14
Stud (89 mm × 0.0081 RSI/mm)	0.72	-
Insulation (89 mm)	-	2.11
Polyethylene (vapour barrier)	-	-
Gypsum (13 mm × 0.0061 RSI/mm)	0.08	0.08
Interior film	0.12	0.12
Total	2.21	3.60
Percent of total area	19%	81%
$RSI_T = 100 \div ((19 \div 2.21) + (81 \div 3.60))$ $= 3.22$		
Overall thermal transmittance = 0.311		

**Example 2: Attic with Wood Trusses**

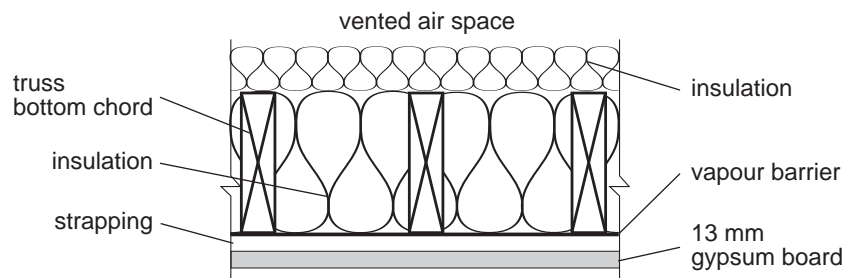

Wood trusses @ 610 mm o.c., RSI 7.04 loose fill insulation		
Components	RSI <sub>F</sub> through insulation and wood member, m <sup>2</sup> ·°C/W	RSI <sub>I</sub> through insulation, m <sup>2</sup> ·°C/W
Outside air film (does not count - vented roof)	-	-
Asphalt shingles (does not count - vented roof)	-	-
Oriented strand board, waferboard or plywood (does not count - vented roof)	-	-
Roof air space (like outside film)	0.03	0.03
Bottom chord (89 mm × 0.0081 RSI/mm + insulation)	5.54	-
Batt insulation (279 mm)	-	7.04
Polyethylene (vapour barrier)	-	-
Air space (created by strapping)	0.15	0.15
Gypsum (13 mm × 0.0061 RSI/mm)	0.08	0.08
Interior film	0.11	0.11
Total	5.91	7.41
Percent of total area	7%	93%
$RSI_T = 100 \div ((7 \div 5.91) + (93 \div 7.41))$ $= 7.28$		
Overall thermal transmittance = 0.137		

## Appendix C

Example 3: Roof-joist-type Roof

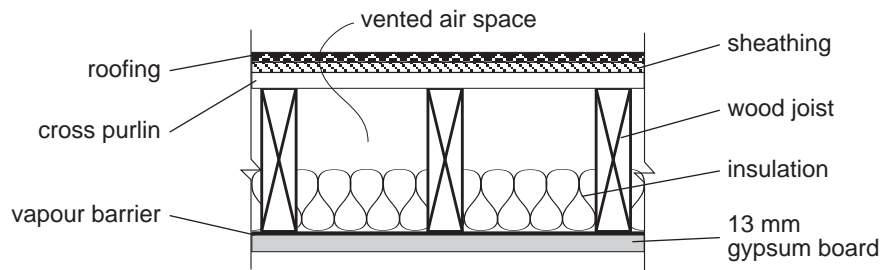

235 mm roof joists @ 610 mm o.c., RSI 4.93 batt insulation		
Components	RSI <sub>F</sub> through wood member, m <sup>2</sup> ·°C/W	RSI <sub>I</sub> through insulation, m <sup>2</sup> ·°C/W
Outside air film (does not count - vented roof)	-	-
Asphalt shingles (does not count - vented roof)	-	-
Oriented strand board, waferboard or plywood (does not count - vented roof)	-	-
Roof air space (like outside film)	0.03	0.03
Roof joist 235 mm (203 mm × 0.0081 RSI/mm)	1.64	-
Batt insulation (203 mm)	-	4.93
Polyethylene (vapour barrier)	-	-
Gypsum (13 mm × 0.0061 RSI/mm)	0.08	0.08
Interior film	0.11	0.11
Total	1.86	5.15
Percent of total area	7%	93%
$RSI_T = 100 \div ((7 \div 1.86) + (93 \div 5.15))$ $= 4.58$		
Overall thermal transmittance = 0.218		

**Example 4: Roof Deck<sup>(1)</sup>**

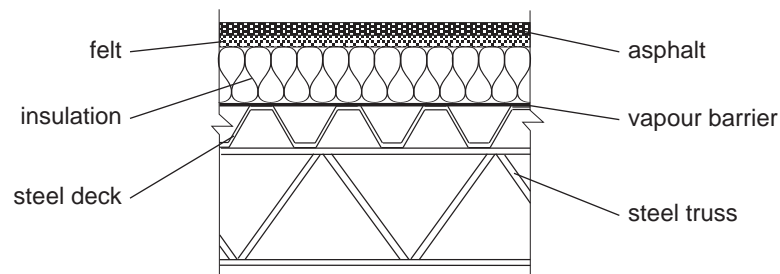

RSI 2.88 expanded polystyrene	
Components	RSI through insulation, $m^2 \cdot ^\circ C/W$
Outside air film	0.03
4-ply roofing and ballast	0.06
Expanded polystyrene II (102 mm $\times$ 0.028 RSI/mm)	2.88
Metal deck	0.001
Interior film	0.11
Total	3.08
$RSI_T = 3.08$	
Overall thermal transmittance = 0.325	

(1) In this case there is no framing, so the calculation is just a matter of adding the thermal resistances and taking the reciprocal.

## Appendix C

### Assemblies with Metal Framing

Where the overall thermal transmittance of a building envelope assembly containing metal framing cannot be determined from the tables in Appendix B, the procedure described herein shall be used.

The procedure described above for wood-framed assemblies involves simple one-dimensional heat flow calculations, based on the assumption that the heat flow through the thermal bridge is parallel to the heat flow through the insulation. Another possible assumption is that the temperature at each plane is constant (typical of panels sandwiched between highly conductive panels).

Tests performed at the Institute for Research in Construction and elsewhere on metal-frame walls have shown that neither of the above assumptions properly represents the highly two-dimensional heat flow that actually occurs and that the differences between what is assumed and what actually occurs are significant with metal-framed assemblies. Europeans have been using the method described here with some degree of confidence. Comparisons with test results suggest that this method provides a good approximation if a value for the conductivity of steel of about  $62 \text{ W}\cdot\text{m}/\text{m}^2\cdot^\circ\text{C}$  (resistivity =  $0.000161 \text{ m}^2\cdot^\circ\text{C}/\text{W}$  per mm) is used. This value, which is associated with galvanized steel with a carbon content of 0.14%, is the value used in this Code.

This method involves five steps:

- (1) The effective thermal resistance is calculated, as described above for wood-framed assemblies. In this case, the result is designated  $RSI_{T1}$ .
- (2) A similar calculation is carried out for those components of the assembly between the planes bounding the inner and outer faces of the metal framing members. This result is designated  $RSI_{T2}$ .
- (3)  $RSI_{T2}$  is added to the resistances of the remaining components in the assembly (other than the insulation) to derive  $RSI_{T3}$ .
- (4)  $RSI_{T1}$  and  $RSI_{T3}$  are combined using the following formula:

$$RSI_T = K_1 \cdot RSI_{T1} + K_2 \cdot RSI_{T3}$$

where  $K_1$  and  $K_2$  are as follows:

Framing Spacing, mm	$K_1$	$K_2$
< 500, without insulating sheathing	1/3	2/3
< 500, with insulating sheathing	2/5	3/5
$\geq 500$	1/2	1/2

- (5) The reciprocal of  $RSI_T$  yields the overall thermal transmittance.

**Example 5: Steel Frame Wall**

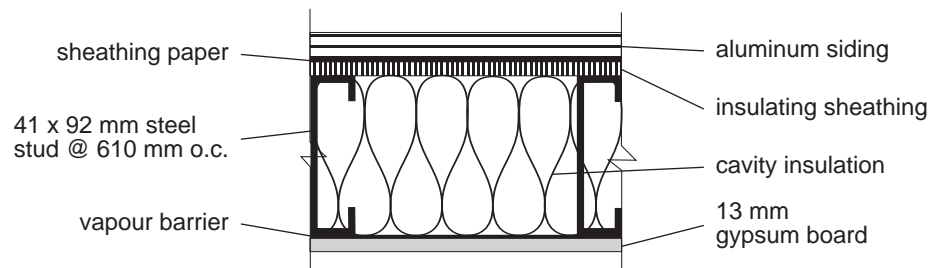

41 x 92 mm steel studs @ 610 mm o.c., RSI 2.11 batts, RSI 1.33 extruded polystyrene insulation		
<b>Step 1</b>		
Components	RSI <sub>F</sub> through steel stud, m <sup>2</sup> ·°C/W	RSI <sub>I</sub> through insulation, m <sup>2</sup> ·°C/W
Outside air film	0.03	0.03
Brick veneer	0.07	0.07
Air space	0.18	0.18
Sheathing paper	0.01	0.01
Extruded polystyrene (38 mm × 0.035 RSI/mm)	1.33	1.33
Steel stud (92 mm × 0.0000161 RSI/mm)	0.00148	-
Insulation (89 mm)	-	2.11
Polyethylene (vapour barrier)	-	-
Gypsum (13 mm × 0.0061 RSI/mm)	0.08	0.08
Interior film	0.12	0.12
Total	1.82	3.93
Percent of total area	0.37%	99.63%
$RSI_{T1} = 100 \div ((0.37 \div 1.82) + (99.63 \div 3.93))$ $= 3.91$		
<b>Step 2</b>		
Components	RSI through steel stud, m <sup>2</sup> ·°C/W	RSI through insulation, m <sup>2</sup> ·°C/W
Steel stud (92 mm × 0.0000161 RSI/mm)	0.00148	-
Insulation (89 mm)	-	2.11
Total	0.00148	2.11
Percent of total area	0.37%	99.63%
$RSI_{T2} = 100 \div ((0.37 \div 0.00148) + (99.63 \div 2.11))$ $= 0.34$		

## Appendix C

Step 3	
Components	RSI through steel stud and insulation, m <sup>2</sup> ·°C/W
Outside air film	0.03
Brick veneer	0.07
Air space	0.18
Sheathing paper	0.01
Extruded polystyrene (38 mm × 0.035 RSI/mm)	1.33
RSI <sub>T2</sub>	0.34
Polyethylene (vapour barrier)	-
Gypsum (13 mm × 0.0061 RSI/mm)	0.08
Interior film	0.12
Total	2.16
RSI <sub>T3</sub> = 2.16	
Step 4	
$\begin{aligned} \text{RSI}_T &= (\text{RSI}_{T1} + \text{RSI}_{T3}) \div 2 \\ &= (3.91 + 2.16) \div 2 \\ &= 3.04 \end{aligned}$	
Step 5	
$\begin{aligned} \text{Overall thermal transmittance} &= 1 \div 3.04 \\ &= 0.329 \end{aligned}$	

**Masonry Assemblies**

Where the overall thermal transmittance of a building envelope assembly containing masonry cannot be determined from the tables in Appendix B, the procedure described herein shall be used.

**Example 6: Concrete Block Wall with Wood Framing**

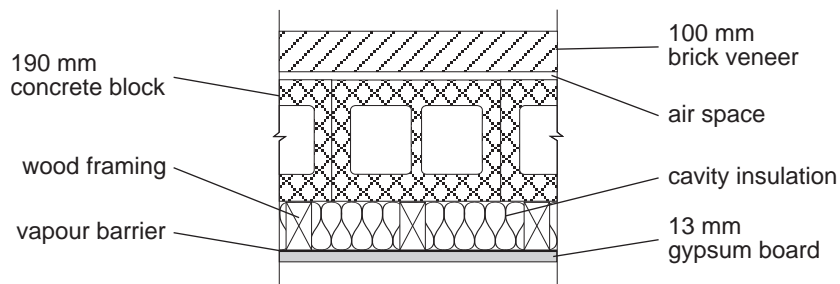

38 x 89 mm wood studs @ 610 mm o.c., RSI 2.11 batts added to a concrete block wall		
Components	RSI <sub>F</sub> through stud, m <sup>2</sup> ·°C/W	RSI <sub>I</sub> through insulation, m <sup>2</sup> ·°C/W
Exterior film	0.03	0.03
Brick veneer	0.07	0.07
Air space	0.18	0.18
190 mm concrete block (normal weight)	0.21	0.21
Stud (89 mm × 0.0081 RSI/mm)	0.72	-
Insulation (89 mm)	-	2.11
Polyethylene (vapour barrier)	-	-
Gypsum (13 mm × 0.0061 RSI/mm)	0.08	0.08
Interior film	0.12	0.12
Total	1.41	2.80
Percent of total area	11%	89%
$RSI_T = 100 \div ((11 \div 1.41) + (89 \div 2.80))$ $= 2.53$		
Overall thermal transmittance = 0.396		

## Appendix C

### Below-Grade Assemblies

Where the overall thermal transmittance of a building envelope assembly that is below grade cannot be determined from the tables in Appendix B, the procedure described herein shall be used.

The only difference in calculating thermal resistance values for below-grade assemblies is that no external air film is included.

Although the resistance of the soil has a bearing on the heat loss through below-grade assemblies, for purposes of compliance with this Code, it is not included in the thermal resistance calculation.

**Example 7: Framed Batts Added to a Foundation Wall**

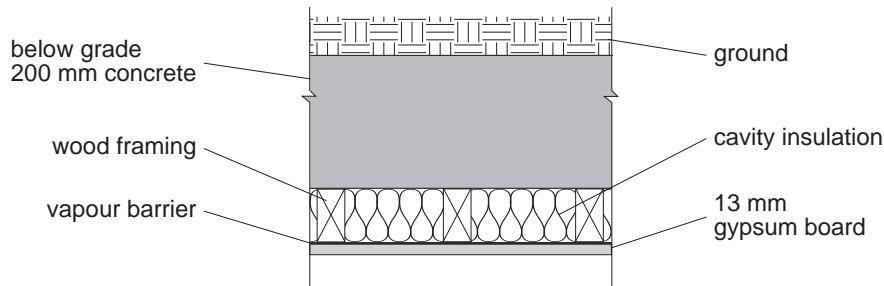

38 x 89 mm wood studs @ 610 mm o.c., RSI 2.11 batts added to a concrete wall		
Components	RSI <sub>F</sub> through stud, m <sup>2</sup> ·°C/W	RSI <sub>I</sub> through insulation, m <sup>2</sup> ·°C/W
200 mm concrete	0.08	0.08
Building paper	0.01	0.01
Stud (89 mm × 0.0081 RSI/mm)	0.72	-
Insulation (89 mm)	-	2.11
Polyethylene (vapour barrier)	-	-
Gypsum (13 mm × 0.0061 RSI/mm)	0.08	0.08
Interior film	0.12	0.12
Total	1.01	2.40
Percent of total area	10%	90%
$RSI_T = 100 \div ((10 \div 1.01) + (90 \div 2.40))$ $= 2.11$		
Overall thermal transmittance = 0.474		

**Area Percentages**

Where the actual percentages of the building assembly area that are underlaid by framing and by insulation are known, these values should be used. Otherwise, the values in Table C-1 shall be used. These values include allowance for typical mixes of studs, lintels and plates.

**Table C-1  
Framing Percentages for Typical Wood- and Steel-framed Assemblies**

Assembly	Framing Spacing, mm	Wood Framing		Steel Framing <sup>(1)</sup>	
		Area With Framing, %	Area Without Framing, %	Area With Framing, %	Area Without Framing, %
Roofs, ceilings, floors	< 500	10	90	0.33	99.67
	≥ 500	7	93	0.23	99.77
Above-grade walls and strapping	< 500	19	81	0.63	99.37
	≥ 500	11	89	0.37	99.63
Below-grade walls and strapping	< 500	17	83	0.57	99.43
	≥ 500	10	90	0.33	99.67
Sheet steel wall	< 2100	-	-	0.08	99.92
	≥ 2100	-	-	0.06	99.94

**Notes to Table C-1:**

(1) Percentages for steel framing are based on 18-gauge (1.2 mm) steel; however, test results indicate that, for the range of thicknesses normally used in light steel framing, the actual thickness has very little effect on the overall thermal transmittance.

**Table C-2  
Thermal Properties for Building Materials**

Description	Thermal resistance				Conductivity, W/m·°C
	Per mm, <sup>(1)</sup> m <sup>2</sup> ·°C/W/mm	For thickness listed, m <sup>2</sup> ·°C/W	Range, m <sup>2</sup> ·°C/W/mm		
<b>Air Films</b>					
Exterior: ceiling, floors and walls		0.03			
Interior: ceiling (heat flow up)		0.11			
floor (heat flow down)		0.16			
walls (heat flow horizontal)		0.12			

# Appendix C

Table C-2 (Continued)

Description	Thermal resistance				Conductivity, W/m·°C
	Per mm, <sup>(1)</sup> m <sup>2</sup> ·°C/W/mm	For thickness listed, m <sup>2</sup> ·°C/W	Range, m <sup>2</sup> ·°C/W/mm		
<b>Air Cavities<sup>(3)</sup></b>					
Ceiling (heat flow up):					
Faced with non-reflective material <sup>(4)</sup>	13 mm air space	0.15			0.09
	20 mm air space	0.15			0.13
	40 mm air space	0.16			0.25
	90 mm air space	0.16			0.56
Faced with 1 reflective material <sup>(4)</sup>	13 mm air space	0.28			0.05
	20 mm air space	0.30			0.07
	40 mm air space	0.32			0.13
	90 mm air space	0.34			0.26
Faced with 2 reflective materials <sup>(4)</sup>	13 mm air space	0.36			0.04
	20 mm air space	0.39			0.05
	40 mm air space	0.42			0.10
	90 mm air space	0.47			0.19
Floors (heat flow down):					
Faced with non-reflective material <sup>(4)</sup>	13 mm air space	0.16			0.08
	20 mm air space	0.18			0.11
	40 mm air space	0.20			0.20
	90 mm air space	0.22			0.41
Faced with 1 reflective material <sup>(4)</sup>	13 mm air space	0.33			0.04
	20 mm air space	0.42			0.05
	40 mm air space	0.58			0.07
	90 mm air space	0.72			0.13
Faced with 2 reflective materials <sup>(4)</sup>	13 mm air space	0.45			0.03
	20 mm air space	0.63			0.03
	40 mm air space	1.04			0.04
	90 mm air space	1.63			0.06
Walls (heat flow horizontal):					
Faced with non-reflective material <sup>(4)</sup>	13 mm air space	0.16			0.08
	20 mm air space	0.18			0.11
	40 mm air space	0.18			0.22
	90 mm air space	0.18			0.50
Faced with 1 reflective material <sup>(4)</sup>	13 mm air space	0.33			0.04
	20 mm air space	0.41			0.05
	40 mm air space	0.42			0.10
	90 mm air space	0.41			0.22
Faced with 2 reflective materials <sup>(4)</sup>	13 mm air space	0.45			0.03
	20 mm air space	0.61			0.03
	40 mm air space	0.62			0.06
	90 mm air space	0.60			0.15



# Appendix C

Table C-2 (Continued)

Description	Thermal resistance				Conductivity, W/m·°C	
	Per mm, <sup>(1)</sup> m <sup>2</sup> ·°C/W/ mm	For thickness listed, m <sup>2</sup> ·°C/W	Range, m <sup>2</sup> ·°C/W/mm			Min. Req'd, <sup>(2)</sup> m <sup>2</sup> ·°C/W/ mm
<b>Insulation</b>						
Blanket and Batt:						
Mineral fibre (rock, slag, or glass):						
low-density	0.024			0.0185	0.042	
medium-density	0.026			0.0185	0.039	
high-density	0.028			0.0185	0.036	
Board and Slabs:						
Cellular glass	0.021				0.048	
Insulating fibreboard:						
Roof board	0.018			0.0182	0.055	
Building board or ceiling tile, lay-in panel	0.016			0.0164	0.061	
Polyisocyanurate/polyurethane faced sheathing (CGSB 51.25, Type 1)	0.042			0.0420	0.024	
Polyisocyanurate/polyurethane unfaced and faced board (CGSB 51.25 Types 2, 3 and 4)	0.042			0.0420	0.024	
Polystyrene:						
Expanded: Type 1	0.026		0.026	0.027	0.0260	0.038
Type 2	0.028		0.028	0.029	0.0280	0.035
Type 3	0.030		0.030	0.030	0.0296	0.034
Extruded: Types 2, 3 and 4	0.035		0.034	0.035	0.0344	0.029
Faced phenolic foam board:						
Closed cells	0.042				0.024	
Open cells	0.030				0.033	
Rigid glass fibre roof insulation	0.021		0.020	0.025	0.0200	0.047
Semi-rigid glass fibre sheathing	0.030		0.019	0.031	0.0185	0.034
Loose Fill:						
Cellulose	0.025		0.025	0.027	0.0247	0.040
Mineral fibre (rock, slag or glass)	0.020		0.019	0.025	0.0185	0.050
Perlite	0.019		0.017	0.026		0.053
Vermiculite	0.015		0.015	0.016		0.067
Spray Applied:						
Cellulosic fibre	0.024		0.022	0.027		0.041
Glass fibre	0.026		0.026	0.027		0.039
Polyurethane foam	0.042		0.039	0.043		0.024
<b>Structural Materials</b>						
Concrete:						
Low density aggregate:						
expanded shale, clay, slate or slags, cinders (1600 kg/m <sup>3</sup> )	0.0013		0.0012	0.0015		0.75
perlite, vermiculite and polystyrene bead (480 kg/m <sup>3</sup> )	0.0063					0.16
Sand and gravel or stone aggregate (2400 kg/m <sup>3</sup> )	0.0004		0.0004	0.0007		2.3
Hardwood	0.0061					0.16
Softwood:						
California redwood or cedar	0.0090		0.0077	0.0103		0.11
Douglas fir, southern pine or larch	0.0071		0.0062	0.0073		0.14
White pine, fir, or spruce logs and lumber	0.0081		0.0077	0.0093		0.12
Steel, galvanized sheet, 0.14% carbon content	0.0000161					62

**Table C-2 (Continued)**

Description	Thermal resistance				Conductivity, W/m·°C
	Per mm, <sup>(1)</sup> m <sup>2</sup> ·°C/W/ mm	For thickness listed, m <sup>2</sup> ·°C/W	Range, m <sup>2</sup> ·°C/W/mm		
<b>Concrete blocks</b>					
Limestone aggregate — 2 cores:					
cores filled with perlite:	190 mm	0.37			0.51
	290 mm	0.65			0.45
Light Weight Units (expanded shale, clay, slate or slag aggregate) — 2 or 3 cores:					
no core insulation:	90 mm	0.24			0.38
	140 mm	0.30	0.26	0.34	0.47
	190 mm	0.32	0.30	0.56	0.44
	240 mm	0.33			0.73
	290 mm	0.41	0.36	0.46	0.71
cores filled with perlite:	140 mm	0.74			0.19
	190 mm	0.99	0.77	1.20	0.19
	290 mm	1.35	1.10	1.60	0.21
cores filled with vermiculite:	140 mm	0.58	0.53	0.62	0.24
	190 mm	0.81	0.69	0.93	0.23
	240 mm	0.98			0.24
	290 mm	1.06	1.00	1.13	0.27
cores filled with molded EPS beads	190 mm	0.85			0.22
molded EPS inserts in cores:	190 mm	0.62			0.31
Medium Weight Units (combination of normal and low mass aggregate) —2 or 3 cores:					
no core insulation:	190 mm	0.26	0.22	0.30	0.73
cores filled with EPS molded beads:	190 mm	0.56			0.34
EPS molded inserts in cores:	190 mm	0.47			0.40
cores filled with perlite:	190 mm	0.53	0.41	0.65	0.36
cores filled with vermiculite:	190 mm	0.58			0.33
Normal Weight Units (sand and gravel aggregate) — 2 or 3 cores:					
no core insulation:	90 mm	0.17			0.53
	140 mm	0.19			0.74
	190 mm	0.21	0.17	0.21	0.9
	240 mm	0.24			1.0
	290 mm	0.26	0.22	0.26	1.1
cores filled with perlite:	190 mm	0.35			0.54
cores filled with vermiculite:	140 mm	0.40			0.35
	190 mm	0.51	0.24	0.51	0.37
	240 mm	0.61			0.39
	290 mm	0.69			0.42

# Appendix C

Table C-2 (Continued)

Description	Thermal resistance				Conductivity, W/m·°C
	Per mm, <sup>(1)</sup> m <sup>2</sup> ·°C/W/mm	For thickness listed, m <sup>2</sup> ·°C/W	Range, m <sup>2</sup> ·°C/W/mm		
<b>Hollow Clay Bricks</b>					
Hollow Clay Brick — multi-cored:					
no insulation in cores:	90 mm	0.27			0.33
Hollow Clay Brick — rectangular 2-core:					
no insulation in cores:	140 mm	0.39			0.36
	190 mm	0.41			0.46
	290 mm	0.47			0.62
cores filled with vermiculite:	140 mm	0.65			0.22
	190 mm	0.86			0.22
	290 mm	1.29			0.22
Hollow Clay Brick — rectangular 3-core:					
no insulation in cores:	90 mm	0.35			0.26
	140 mm	0.38			0.37
	190 mm	0.41			0.46
	240 mm	0.43			0.56
	290 mm	0.45			0.64
cores filled with vermiculite:	140 mm	0.68			0.21
	190 mm	0.86			0.22
	240 mm	1.06			0.23
	290 mm	1.19			0.24
<b>Interior finish materials<sup>(6)</sup></b>					
Building Board:					
Gypsum board		0.0061			0.16
Hardboard:	medium-density (800 kg/m <sup>3</sup> )	0.0095			0.11
Interior finish (plank, tile) board		0.0198			0.05
Particleboard:	low-density (590 kg/m <sup>3</sup> )	0.0098			0.10
	medium-density (800 kg/m <sup>3</sup> )	0.0074			0.14
	high-density (1000 kg/m <sup>3</sup> )	0.0059			0.17
	underlay (15.9 mm)		0.14		0.11
Plywood		0.0087			0.12
Flooring Material:					
Carpet and fibrous pad			0.37		
Carpet and rubber pad			0.22		
Cork tile:	3.2 mm		0.049		0.07
Hardwood flooring:	19 mm		0.12		0.16
Terrazzo:	25 mm		0.014		1.8
Tile (linoleum, vinyl, rubber)			0.009		0.17
Tile (ceramic):	9.5 mm		0.005		1.9
Wood subfloor:	19 mm		0.17		0.11
Plastering:					
Cement plaster:	sand aggregate	0.0014			0.70
Gypsum plaster:	low-density aggregate	0.0044			0.23
	sand aggregate	0.0012			0.82

**Table C-2 (Continued)**

Description	Thermal resistance				Conductivity, W/m·°C
	Per mm, <sup>(1)</sup> m <sup>2</sup> ·°C/W/ mm	For thickness listed, m <sup>2</sup> ·°C/W	Range, m <sup>2</sup> ·°C/W/mm	Min. Req'd, <sup>(2)</sup> m <sup>2</sup> ·°C/W/ mm	
<b>Sources:</b>					
<ul style="list-style-type: none"> <li>• ASHRAE 1997 Handbook — Fundamentals, Chapter 24, Tables 1, 3 and 4. American Society of Heating, Refrigerating and Air Conditioning Engineers, Inc., Atlanta, GA 30329, 1993.</li> <li>• Builders Manual, Canadian Home Builders' Association, Ottawa, ON K1P 5J4, 1994.</li> <li>• Registry of Product Evaluations, Summer 1994. NRC, Ottawa, ON K1A 0R6, 1994.</li> </ul>					

**Notes to Table C-2:**

- (1) The thermal resistance values given in Table C-2 are generic values for the types of materials listed. Actual materials produced by manufacturers may have values that differ slightly. A manufacturer's published value for a material may be used, provided it has been obtained in accordance with the procedures described in Article 2.2.2.2. of the Code. The Canadian Construction Materials Centre (CCMC) provides evaluation reports for certain insulation materials; these reports are a reliable source of information on thermal resistance values.
- (2) Minimum requirement as per applicable product standard (not the MNECB).
- (3) Interpolation for air spaces between values listed and moderate extrapolation for air spaces greater than 90 mm is permissible; no credit for air spaces less than 13 mm.
- (4) These values may not be used in calculations for areas where the mean annual total degree-days exceed 4400 Celsius degree-days. For those areas over 4400 Celsius degree-days, use Air Cavities Faced with Non-Reflective Materials.
- (5) No credit for materials to the exterior of vented air space.
- (6) No credit for materials to the interior of conditioned air space.



# Appendix D

## Energy Source Adjustment Factors

One use of the energy source adjustment factor (ESAF) is in the identification of the principal heating source of a building or part of a building, in order to establish the level of regional prescriptive requirements read from the Tables in Appendix A (see the definition of energy source adjustment factor in Part 1 of this Code). In determining the principal heating source, alternative energy sources, such as wind energy, wood derivatives or waste energy recuperated from outside the building, are generally included in the “Other” category. Solar heat gains and heat recovered within the mechanical systems are not assigned an ESAF since they are never the principal heating source and they are otherwise taken into consideration in the calculations related to the performance compliance path.

The impact of the ESAF of alternative energy sources is made less important in the performance

compliance path by the provision that comparison always be made with the same fuel in both the projected building and the reference building, in order for the Model National Energy Codes to remain neutral with respect to energy sources and avoid systematic comparison with the worst fuel. This results in credit being given only to improvements in efficiency of each system over the minimum equipment standards. The Model National Energy Codes, whose objectives are to set minimum standards in the construction of buildings, are not intended to be used in the promotion of some energy sources against others.

Table D-1 contains regional ESAF used by the computer-assisted trade-off software and the performance compliance software.

**Table D-1**  
**Energy Source Adjustment Factors**

Province or Territory	Region	Energy Source					
		Electricity	Propane	Oil	Natural Gas	Heat Pump, Electric	Other
Newfoundland	A	1	0.70	0.22	—	0.33	1
	B	1	0.70	0.17	—	0.33	1
	C	1	0.70	0.57	—	0.33	1
	D	1	0.70	0.79	—	0.33	1
P.E.I.	A	1	0.49	0.30	—	0.33	1
Nova Scotia	A	1	0.45	0.23	—	0.33	1
New Brunswick	A	1	0.87	0.34	—	0.33	1
Québec	A	1	0.54	0.54	0.53	0.33	1
	B	1	0.54	0.54	0.53	0.33	1
	C	1	0.54	0.54	—	0.33	1
Ontario	A	1	0.28	0.28	0.20	0.33	1
	B	1	0.28	0.28	0.20	0.33	1

## Appendix D

Table D-1 (Continued)

Province or Territory	Region	Energy Source					
		Electricity	Propane	Oil	Natural Gas	Heat Pump, Electric	Other
Manitoba	A	1	0.48	0.48	0.31	0.33	1
	B	1	0.48	0.48	0.31	0.33	1
Saskatchewan	A	1	1	1	0.16	0.33	1
Alberta	A	1	0.53	0.53	0.15	0.33	1
	B	1	0.53	0.53	0.15	0.33	1
	C	1	0.53	0.53	0.15	0.33	1
British Columbia	A	1	0.43	0.43	0.36	0.33	1
	B	1	0.48	0.48	BCG 0.35 PNG 0.37	0.33	1
	C	1	0.45	0.45	0.40	0.33	1
	D	1	0.48	0.48	0.35	0.33	1
	E	1	0.58	0.58	0.41	0.33	1
Yukon	A	1	0.44	0.29	—	0.33	1
	B	1	0.26	0.17	—	0.33	1
	C	1	—	0.18	—	0.33	1
Northwest Territories	A	1	0.19	0.19	—	0.33	1
	B	1	0.27	0.24	—	0.33	1
	C	1	0.17	0.17	0.05	0.33	1
	D	1	0.11	0.11	—	0.33	1
	E	1	0.10	0.10	—	0.33	1
	F	1	0.10	0.10	—	0.33	1
	G	1	0.09	0.09	—	0.33	1
	H	1	0.10	0.10	—	0.33	1

---

# Appendix E

## Commentary

**E-1.1.2.1.(1) Buildings Covered by this Code.** This Code applies to buildings at construction time: for example, for shell-type buildings, the Code applies to the shell at the time of its construction and to the rest — heating, ventilating and air-conditioning, lighting, service water heating, electrical power — as these are built.

This Code applies to new buildings and to additions. For the purpose of understanding the scope of this Code, an addition can be thought of as a new building or building part that happens to be built contiguous to an existing building. Most of the requirements in this Code are based on cost/benefit analyses using costs relevant to new construction. Since additions are essentially new construction, the economic parameters used to establish the levels of requirement for this Code can apply to additions as well as to new buildings. However, because the costs of renovating to existing buildings are significantly different from the costs of new construction, this Code should generally not be applied to the renovation of existing buildings.

It should be noted that, in extending existing systems to serve a new building addition, the existing systems and equipment do not have to be upgraded to meet the Code; only the new components of such systems and any new equipment installed to serve the addition need comply with this Code.

**E-1.1.2.1.(2) Buildings Covered by the Model National Energy Code for Houses 1997.** This wording meets the scope of Part 9 of the National Building Code of Canada (NBC) as defined in Article 2.1.3.1. of the NBC, except that it excludes occupancies other than dwelling units. Therefore, the Model National Energy Code for Buildings (MNECB) would not apply to any single-family house no matter its size, but would apply to the following:

- buildings more than three storeys in building height,
- buildings of three storeys or less in building height having a building area of more than 600 m<sup>2</sup>,
- buildings of three storeys or less in building height that contain occupancies other than dwelling units.

**E-1.1.2.1.(5) Special Occupancy Requirements. Exemptions from certain requirements.** In a few buildings, the intended use or occupancy may be such that compliance with some requirements could limit or prevent the building from performing its intended function. Examples of such buildings are as follows, but this list is not exhaustive:

- horticultural, silvicultural and botanical greenhouses,
- greenhouses used for research,
- temporary exhibition buildings and sports facilities.

In such cases, the nature of the occupancy could be considered to make compliance impractical. This article permits the authority having jurisdiction to review such special cases and to permit deviations. Only the nature of the occupancy, rather than economic or other factors, is to be considered in permitting such deviations.

It is difficult for a code to foresee all exceptions. Specifically solving in this Code all foreseen cases would not eliminate the need to provide generally for the unforeseen and would likely make the Code more complex and hamper its everyday use. However, each part of this Code tries to deal with exceptions in a more specific way and Appendix notes give some guidance on possible exceptions (see Sentences 3.1.1.1.(4), 4.1.1.1.(2), 5.1.1.1.(2) and 6.1.1.1.(2)).

**E-1.1.3.1.(1) Words Not Defined in this Code.** For guidance on heating, ventilation and air-conditioning terminology, the publication “Terminology of Heating, Ventilation, Air-Conditioning and Refrigeration, 2<sup>nd</sup> ed., 1991,” by the American Society of Heating, Refrigerating and Air-Conditioning Engineers (ASHRAE), is a useful source of information.

**E-1.1.3.2.(1) Assembly Occupancy.** The following are examples of the assembly occupancies comprised in the definition:

- Assembly occupancies intended for the production and viewing of the performing arts
  - Motion picture theatres
  - Opera houses
  - Television studios admitting a viewing audience

## E-1.1.3.2.(1)

- Theatres, including experimental theatres
- Assembly occupancies not elsewhere classified
  - Art galleries
  - Auditoria
  - Bowling alleys
  - Churches and similar places of worship
  - Clubs, nonresidential
  - Community halls
  - Court rooms
  - Dance halls
  - Exhibition halls (other than classified in Group E)
  - Gymnasia
  - Lecture halls
  - Libraries
  - Licensed beverage establishments
  - Museums
  - Passenger stations and depots
  - Recreational piers
  - Restaurants
  - Schools and colleges, nonresidential
  - Undertaking premises
- Assembly occupancies of the arena type
  - Arenas
  - Indoor swimming pools with or without spectator seating
  - Rinks
- Assembly occupancies in which occupants are gathered in the open air
  - Amusement park structures (not elsewhere classified)
  - Bleachers
  - Grandstands
  - Reviewing stands
  - Stadia

### E-1.1.3.2.(1) Building Envelope

**Application.** There are several different types of spaces that may be "unconditioned" spaces (e.g., mechanical rooms, crawl spaces, garages, loading docks) that might be treated differently.

There is also a need to consider components that separate spaces that are conditioned to substantially different temperatures (e.g., swimming pools, skating rinks).

### E-1.1.3.2.(1) Business and Personal

**Services Occupancy.** The following are examples of the business and personal services occupancies comprised in the definition:

- Banks
- Barber and hairdressing shops
- Beauty parlours
- Dental offices
- Dry cleaning establishments, self-service, not using flammable or explosive solvents or cleaners
- Laundries, self-service
- Medical offices
- Offices
- Police stations without detention quarters

- Radio stations
- Small tool and appliance rental and service establishments

### E-1.1.3.2.(1) Care or Detention

**Occupancy.** The following are examples of the institutional occupancies comprised in the definition:

- Care or detention occupancies in which persons are under restraint or are incapable of self-preservation because of security measures not under their control
  - Jails
  - Penitentiaries
  - Police stations with detention quarters
  - Prisons
  - Psychiatric hospitals with detention quarters
  - Reformatories with detention quarters
- Care or detention occupancies in which persons having cognitive or physical limitations require special care or treatment
  - Children's custodial homes
  - Convalescent homes
  - Hospitals
  - Infirmaries
  - Nursing homes
  - Orphanages
  - Psychiatric hospitals without detention quarters
  - Reformatories without detention quarters
  - Sanitoria without detention quarters

**E-1.1.3.2.(1) Conditioned Space.** This definition of conditioned space is intended to permit the exemption of buildings or parts of buildings that are normally neither heated during winter nor cooled during summer, but which may need some heating or cooling for a limited time. An example of such a building is a sewage pumping station that is normally heated solely by the heat produced by the pumping equipment, but that has a backup heating system to permit repairs and protect from freezing in case of equipment failure. Similarly, one could exempt a tourist information kiosk that is not provided with summer air-conditioning and is equipped with only sufficient heating to help get through the end of the summer season, but is closed in winter. However, a ski lodge that is designed for winter heating but is said to be used only on weekends would not meet the criteria for exemption and would be fully subject to the requirements of the Code, because there is nothing to prevent its use for longer periods in winter.

**E-1.1.3.2.(1) Gross Lighted Area.** Gross lighted area (GLA) cannot be tied to building envelope because building envelope relates only to conditioned space. GLA is used in the calculation of interior lighting power allowance (ILPA) that includes all interior lighting, whether the space is conditioned or not, and some lighting of exterior

spaces. The areas of elevator and service shafts are exempted since lighting, if provided at all, would be significantly less than in other spaces.

Storage rooms  
Warehouses  
Workshops

**E-1.1.3.2.(1) Industrial Occupancy.** The following are examples of the industrial occupancies comprised in the definition:

- High hazard industrial occupancies
  - Bulk plants for flammable liquids
  - Bulk storage warehouses for hazardous substances
  - Cereal mills
  - Chemical manufacturing or processing plants
  - Distilleries
  - Dry cleaning plants
  - Feed mills
  - Flour mills
  - Grain elevators
  - Lacquer factories
  - Mattress factories
  - Paint, varnish and pyroxylin product factories
  - Rubber processing plants
  - Spray painting operations
  - Waste paper processing plants
- Medium hazard industrial occupancies
  - Aircraft hangars
  - Box factories
  - Candy plants
  - Cold storage plants
  - Dry cleaning establishments not using flammable or explosive solvents or cleaners
  - Electrical substations
  - Factories
  - Freight depots
  - Helicopter landing areas on roofs
  - Laboratories
  - Laundries, except self-service
  - Mattress factories
  - Planing mills
  - Printing plants
  - Repair garages
  - Salesrooms
  - Service stations
  - Storage rooms
  - Television studios not admitting a viewing audience
  - Warehouses
  - Wholesale rooms
  - Woodworking factories
  - Workshops
- Low hazard industrial occupancies
  - Creameries
  - Factories
  - Laboratories
  - Power plants
  - Salesrooms
  - Sample display rooms
  - Storage garages including open air parking garages

### E-1.1.3.2.(1) Interior Lighting

#### Spaces within the confines of the building envelope

Given the definition of building envelope, this applies to lighting of all conditioned spaces.

#### Other Sheltered Spaces

Lighting of storage garages (parking garages), bus shelters and retail outlets (such as market stalls) are examples of interior lighting of spaces where the lighting is intended only to light that space and where the spaces are sheltered from the exterior environment but may not be conditioned.

The lighting of a covered exterior walkway may be exterior lighting or interior lighting, depending on whether the lighting is intended to light the area around the walkway or only the walkway itself. If only the covered walkway is lit, limits for lighting interior corridors would apply.

#### Unsheltered Spaces

Examples of occupancies often accommodated within the confines of a building envelope but that can occupy unsheltered, unconditioned space include spaces used on a seasonal basis, such as sidewalk cafés.

**E-1.1.3.2.(1) Mercantile Occupancy.** The following are examples of the mercantile occupancies comprised in the definition:

Department stores  
Exhibition halls  
Markets  
Shops  
Stores  
Supermarkets

**E-1.1.3.2.(1) Principal Heating Source.** For most parts of the country, the building envelope thermal characteristics prescribed in Part 3 vary with the principal heating source. This definition of principal heating source allows a building with more than one source of heat to be arbitrarily subdivided into parts such that different parts have different principal heating sources and, thus, the required building envelope characteristics are different in the different parts. For example, in a gas-heated warehouse with an electrically-heated office attached, the space-heating capacity of the office system could equal more than 10% of the overall space-heating capacity of the building, especially if the warehouse were only heated to a

## E-1.1.3.2.(1)

low temperature. By considering these parts of the building separately, as permitted by this definition, it is not necessary that the envelope of the warehouse comply with the generally higher requirements for electrically heated buildings.

**E-1.1.3.2.(1) Residential Occupancy.** The following are examples of the residential occupancies comprised in the definition:

- Apartments
- Boarding houses
- Clubs, residential
- Colleges, residential
- Convents
- Dormitories
- Hotels
- Houses
- Lodging houses
- Monasteries
- Motels
- Schools, residential

**E-1.1.3.2.(1) Service Room.** Typical examples of service rooms include boiler rooms, furnace rooms, incinerator rooms, garbage-handling rooms, elevator machine rooms and rooms to accommodate air-conditioning or heating appliances, pumps, compressors and electrical equipment. Rooms such as common laundry rooms are not considered to be service rooms.

**E-1.1.3.2.(1) Suite.** Tenancy in the context of the term “suite” applies to both rental and

ownership tenure. In a condominium arrangement, for example, dwelling units are considered separate suites whether or not they are individually owned. In order to be of complementary use, a series of rooms that constitute a suite are in reasonably close proximity to each other and have access to each other either directly by means of a common doorway or indirectly by a corridor, vestibule or other similar arrangement.

The term “suite” does not apply to rooms such as service rooms, common laundry rooms and common recreational rooms that are not leased or under a separate tenure in the context of this Code. Similarly, the term suite is not normally applied in the context of buildings such as schools and hospitals, since the entire building is under a single tenure. A rented room in a nursing home could be considered as a suite if the room was under a separate tenure. A hospital bedroom, on the other hand, is not considered to be under a separate tenure, since the patient has little control of that space, even though he or she pays the hospital a per diem rate for the privilege of using the hospital facilities, which include the sleeping areas.

**E-2.1.1.2. Structure of the Model National Energy Code for Buildings.** Beyond basic mandatory requirements that cannot be by-passed, the MNECB features three alternate routes for compliance. Figure E-2.1.1.2. shows the alternate compliance processes.

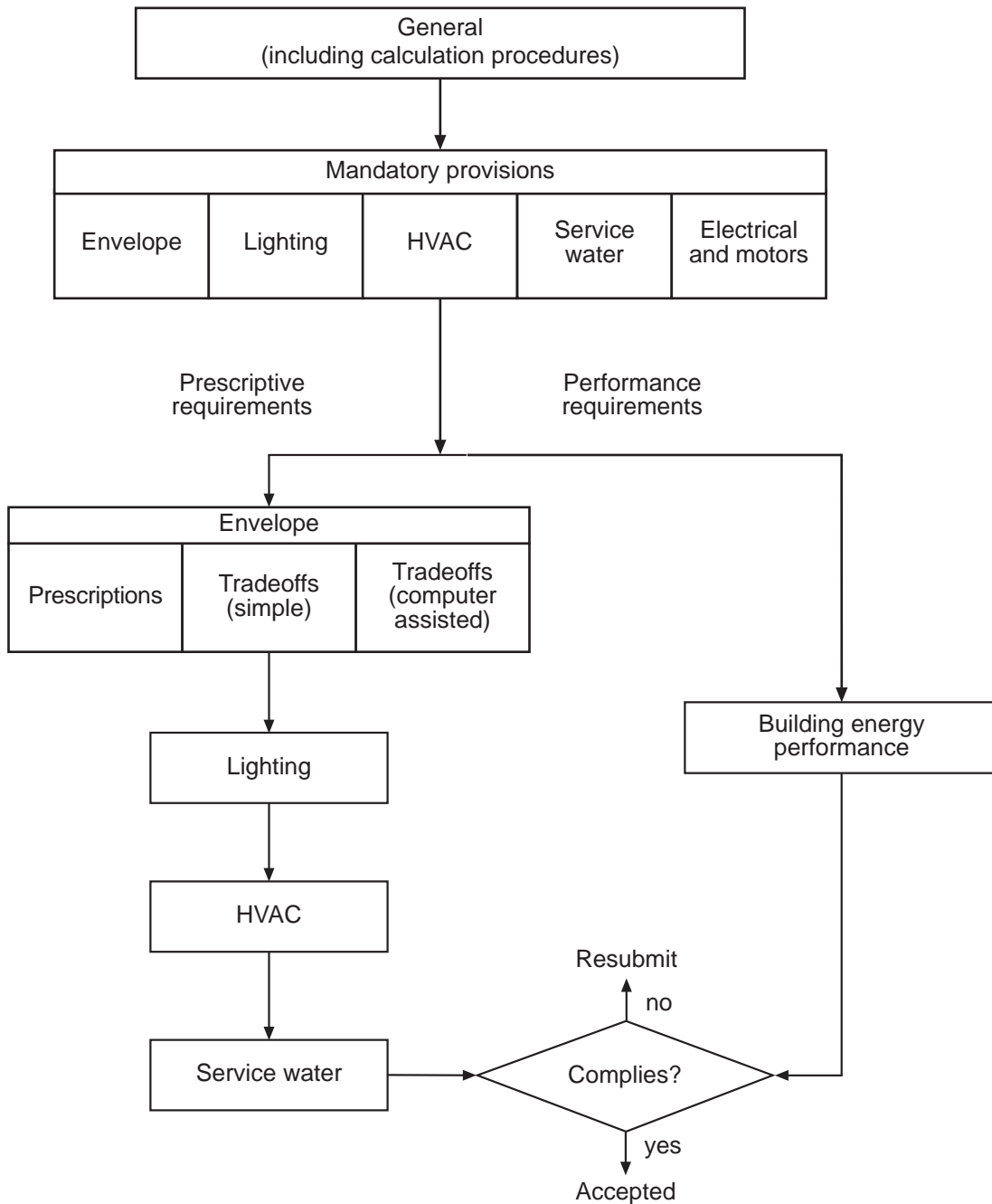

Figure E-2.1.1.2.  
Structure of the Model National Energy Code for Buildings

**Prescriptive Requirements**

The first route is a prescriptive one, which generally dictates minimum thermal characteristics for envelope elements and energy conservation measures that can be stated as specific instructions.

**Trade-offs**

The second route gives some degree of flexibility to the prescriptive requirements related to the building

envelope. It allows the user to reduce thermal resistance in one portion of the envelope, provided that the thermal resistance in other areas is increased so that energy consumption for the building is not increased. This route is meant to be an easy way to make small adjustments to the characteristics of the building envelope without having to go the full performance route.

## E-2.1.1.2.

### Performance Path

The third route is a performance path: if one finds some aspects of the prescriptive route too limiting, one may design a building with any thermal characteristics desired (subject to certain limitations), provided that the building as designed will not have a calculated energy consumption under standardized conditions that is greater than it would have been if the building had been designed in strict conformity with the prescriptive requirements, all other aspects of the building (which are not the object of a requirement in this code) remaining the same in both cases. The proof of conformity in the performance route is made through two energy analyses, one on the building as it would meet the prescriptive requirements, giving the "target" performance, the other on the actual design for which a building permit is requested.

**E-2.2.1.1.(1) Climatic Values.** Data for municipalities not listed in Appendix C of the National Building Code may be obtained by writing to the Atmospheric Environment Service, Environment Canada, 4905 Dufferin Street, Downsview, Ontario M3H 5T4.

**E-2.2.2.2. Thermal Characteristics of Building Assemblies.** Thermal characteristics of building assemblies, including windows, can also be determined through the use of computer simulation models; see Article 2.5.1.3. for provisions for equivalency.

**E-2.2.2.2.(8) Thermal Characteristics of Other Building Assemblies.** Appendix C gives several examples of overall thermal transmittance and effective thermal resistance calculations for some typical building assemblies.

Some literature in this field contains thermal properties of some products that use chlorofluorocarbons (CFCs) as blowing agents. These products are expected to be converted to non-CFC blowing agents, but will likely be referred to by the same generic name. Referenced literature may not be revised by the time this Code is adopted. The reader therefore should be careful not to use outdated information when using these references.

**E-2.2.2.8.(1) Areas of Doors and Fenestration.** This method of calculation of the door and fenestration areas is slightly different from that used in CSA Standard A440.2 for windows and A453 for doors. For calculating the fenestration area of a building, this Code uses the dimensions of rough openings to facilitate compliance checking. In calculating the U-value of a given window type, the manufacturer uses data available at the factory; that is, dimensions to the outside of frame, or the rough opening minus installation clearances, so as not to

take into account projecting surface trim. Figure E-2.2.2.8.(1) illustrates the requirements of Sentence 2.2.2.8.(1) as compared with those of the CSA standard.

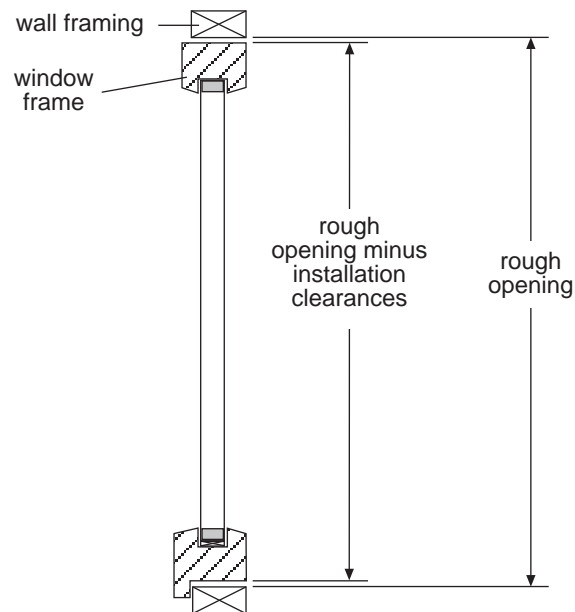

Figure E-2.2.2.8.(1)  
Measuring Area of Glazing

**E-2.2.2.8.(2) Area of Curved Glazing.** Figure E-2.2.2.8.(2) illustrates the requirement of Sentence 2.2.2.8.(2).

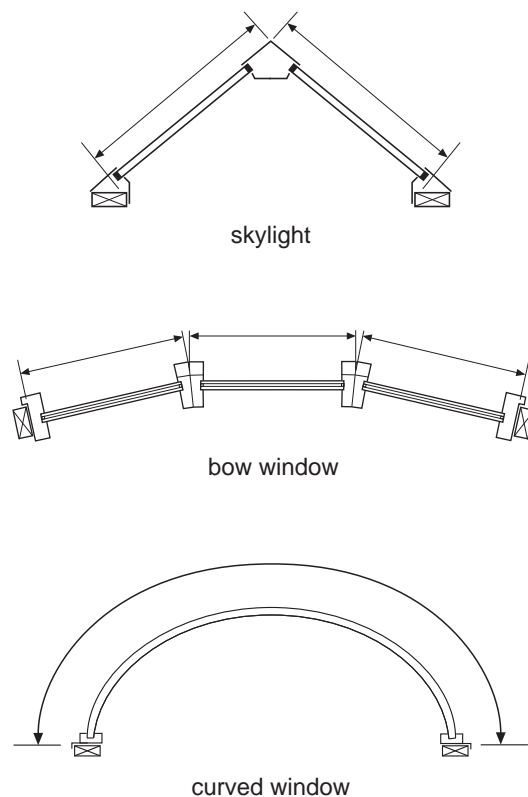

Figure E-2.2.2.8.(2)

## Skylight, Bow Window and Curved Glazing

**E-2.2.2.8.(4) Fenestration-to-Wall Ratio.**

This includes all assemblies that are non-opaque, that is either clear, tinted or translucent, whether glass or plastic, and their frames. See the definition of “fenestration” in Part 1 of this Code. This also includes the vertical projection of areas defined as roofs.

**E-2.3.1.1.(1) Required Information.** The information documenting the conformity of a building to this Code must describe the essential characteristics of the building and its systems. To this end, the authority having jurisdiction would normally require access to the following information:

- floor plan of the building giving the conditioned floor area and gross lighted area for each storey,
- elevations of all the building faces, giving finished floor and ground levels,
- typical cross-sections of foundations, exterior walls, roofs, ceilings and floors that separate conditioned space from unconditioned space or the exterior, describing their construction and giving the thermal resistance of each material and the overall thermal transmittance of each element of the building,
- indoor design temperatures for all spaces,
- required vestibules,
- descriptions of the different types of air barrier systems and their location,

- window dimensions,
- characteristics of fenestration, sliding glass doors and other doors separating conditioned space from unconditioned space or the exterior (overall thermal transmittance and airtightness),
- required report on trade-offs, where applicable,
- details of required exterior lighting controls and exterior lighting power for exits, entrances and facades,
- details of required interior lighting controls and interior lighting power,
- identification of static pressure class and leakage class of ducts,
- thermal insulation of pipes and air ducts,
- location of required dampers and of thermostatic controls and cutoffs,
- an indication of the air flow control areas and temperature control zones,
- efficiency of unit and packaged heating and cooling equipment,
- power requirements for the operation of heating, ventilating and cooling systems, with air volumes, and the type of control used for ventilation,
- types and capacities of and controls for the heating and cooling systems, including cooling with exterior air,
- details of pumping systems with variable flow,
- characteristics of heat recovery ventilators, where required,
- efficiency of service water heating equipment,
- service water distribution layouts and controls,
- main electrical distribution and metering layout,
- required report on performance compliance, where applicable.

**E-2.5.1.3.(1) Equivalence Demonstrated by Computer Analysis.** Thermal characteristics of building assemblies may be determined by two- and three-dimensional finite element and finite difference models. “Vision,” “Frame,” “KOBUR,” “TRISCO,” “ISO 2,” “HEAT 2” and “HEATING 7” are such programs, which may also be used to determine equivalency of other computer simulation programs used to perform these calculations. In making such simulations, care must be taken to use the data prescribed in Appendix C of this Code.

**E-3.1.1.1.(2) Application to Seasonal Buildings.** It is often difficult to identify a “seasonal” building (i.e., a building intended to be used only in the summertime). Generally, if a building has a space-heating system installed or provides for the future installation of a space-heating system, it should be considered to fall within the scope of this Part. A stove, pot heater or window air conditioner should not be considered a system in this context, but electric baseboard heaters in the principal rooms should.

### E-3.1.1.1.(3)

**E-3.1.1.1.(3) Application to Low-Energy Buildings.** The maximum design rate of energy use to be calculated here generally is that for heating, ventilating and air-conditioning, service water heating and lighting.

**E-3.1.1.1.(4) Exceptions.** Since any list of exceptions would necessarily be incomplete, a general statement is provided in this Code and examples provided in this Appendix note. Possible exceptions are:

- horticultural, silvicultural and botanical greenhouses, and greenhouses used for research; they may be exempted from the requirements related to fenestration performance and area,
- buildings in which permanent processes produce at all times enough heat that no other heating source is required; they may have their insulation requirements reduced to the extent that the processes can still provide all of the required heating,
- industrial buildings where processes impose large ventilation requirements; they may be exempted from airtightness requirements,
- buildings in which only sufficient radiant heating is provided to improve conditions locally for the occupants without temperature control of the ambient air, such as bus shelters or bleacher areas in some ice arenas; they may be exempted from Part 3 requirements.

**E-3.2.1.2.(1) Continuity of Insulation.** This Sentence is intended to apply to building components such as partitions, chimneys, fireplaces, and columns and beams that are bedded along exterior walls, but not to stud framing and ends of joists. Studs and joists in frame construction are not considered to break the continuity of the insulation, because the method for calculating the overall thermal transmittance of such assemblies described in Appendix C takes their presence into consideration.

**E-3.2.1.2.(3) Continuity of Insulation at Beams and Columns.** The insulation at a spandrel beam may be reduced from the requirements for the surrounding wall without any penalty, provided that the resulting overall thermal transmittance across the building envelope at the spandrel beam is not increased to more than twice the required overall thermal transmittance for the wall (see Figure E-3.2.1.2.(3)). A similar approach may be used for columns in exterior walls. (See also Appendix note to Sentence 3.4.1.1.(5).)

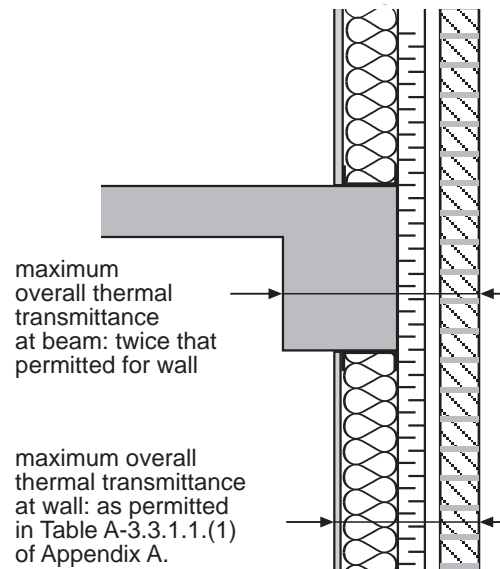

Figure E-3.2.1.2.(3)  
Continuity of Insulation at Beams

**E-3.2.1.2.(9) Overlapping of Insulation Where Continuity Is Not Maintained.** This is the case with foundation walls insulated on the outside below grade and on the inside above grade.

In the case of hollow-core masonry walls, no amount of overlap can overcome the effect of convection in the cores, which renders overlapped interior/exterior insulation totally ineffective, unless the continuity of the air barrier is effectively carried across the wall by blocking the cells at the level of the insulation overlap. Such blocking of the core cells is required by the NBC in Sentences 5.3.1.3.(2) and, for small buildings, by 9.25.2.3.(3), which requires that insulation be installed so its function will not be bypassed by convective air flow.

**E-3.2.1.2.(11) Continuity of Insulation Where Components Meet.** This requirement calls for continuity of the insulation at the intersection of two components of the building envelope, such as a wall with another wall or a roof, or a wall with a window. This means that there should be no gap in the insulation between the two components. An obvious application is insulating the space between a window or door frame and the rough framing members. However, closely-spaced structural members, such as studs or top plates, do not have to be taken into account, as provided in Sentence 3.2.1.2.(2),

**E-3.2.2.1.(3) Reduction of Overall Thermal Transmittance Near the Eaves of Sloped Roofs.** Overall thermal transmittance requirements for attic-type roofs are significantly more stringent than the requirements for walls. The intent of the

requirement is that the overall thermal transmittance permitted directly above the exterior wall must be no more than the overall thermal transmittance permitted for the wall and that, allowing for ventilation requirements, the insulation must be increased with the slope until there is enough space to allow for the installation of the full thickness of insulation required. It is therefore possible that the full required thickness of insulation will not be reached along the ceiling for a significant distance from the perimeter, particularly with a low-slope roof. In the case of a narrow, dormer-type projection

from a main roof, there may not even be enough distance to come to the full required insulation level in the attic space. Sentence 3.2.2.1.(3) is intended to allow for such incidences and permit the use of roof trusses without unduly high raised heels.

**E-3.2.2.2.(1) Wall Area.** Figure E-3.2.2.2.(1) illustrates the extent of the surface that is considered as a wall at the intersection with a floor. This Code may have different requirements for the perimeter area of floors.

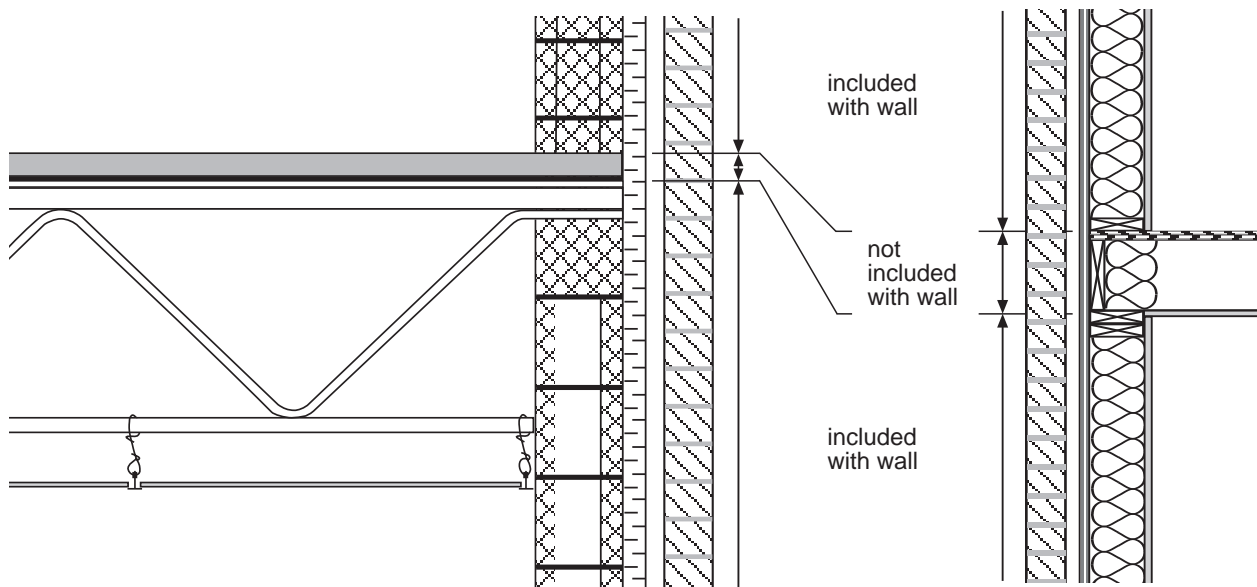

**Figure E-3.2.2.2.(1)**  
Wall Area Discontinuous at Floor

**E-3.2.3.2.(3) Walls in Contact with the Ground.** Concerning the expression “below the exterior ground level,” the reader should note that ground level is different than “grade,” a defined term in the NBC and the MNECB and essentially a horizontal plane at the average exterior ground level. The wording of Sentence 3.2.3.2.(2) requires the bottom of the insulation to follow the contours of the exterior ground level at the required depth.

**E-3.2.3.2.(5) Hollow Core Masonry Walls in Contact with the Ground.**

Figure E-3.2.3.2.(5) The diagrams below illustrate the two alternate approaches for meeting the requirements of Sentence 3.2.3.2.(3) when using hollow core masonry foundation walls.

### E-3.2.3.2.(5)

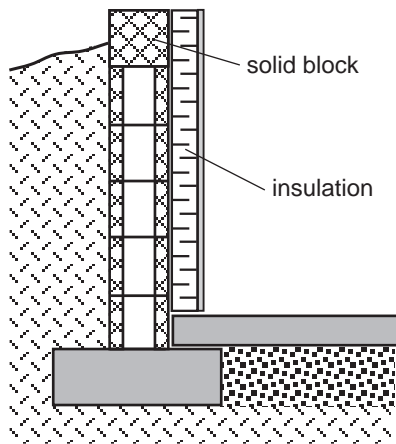

Alternative 1

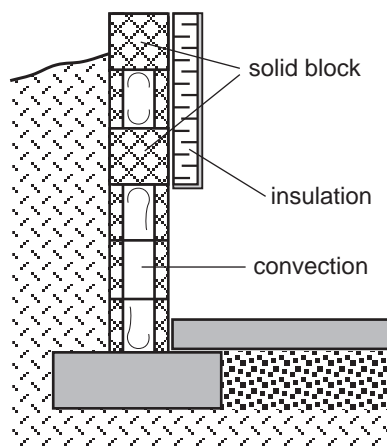

Alternative 2

Figure E-3.2.3.2.(5)

Hollow Core Masonry Foundation Walls

**E-3.2.3.3. Floors in Contact with the Ground.** This is intended to include “floors” of crawl spaces even when there is no actual constructed “floor.” The minimum depth at which insulation is required is measured once for the entire floor from the level of grade (see comment on 3.2.3.2. above); i.e., even if the exterior soil level (ground) varies, the whole floor (or perimeter) either has to be insulated or doesn’t; this doesn’t require some parts of the floor (or perimeter) to be insulated and some parts not. Consideration should be given to insulation of the entire floor at sites where the soil is highly conductive or where there is a permanently high water table. The requirements of this Code do not take ground water level and flow into account; in some cases, higher insulation levels may be justified.

The diagrams in Figure E-3.2.3.3. illustrate the insulation requirements for various types of floors on ground.

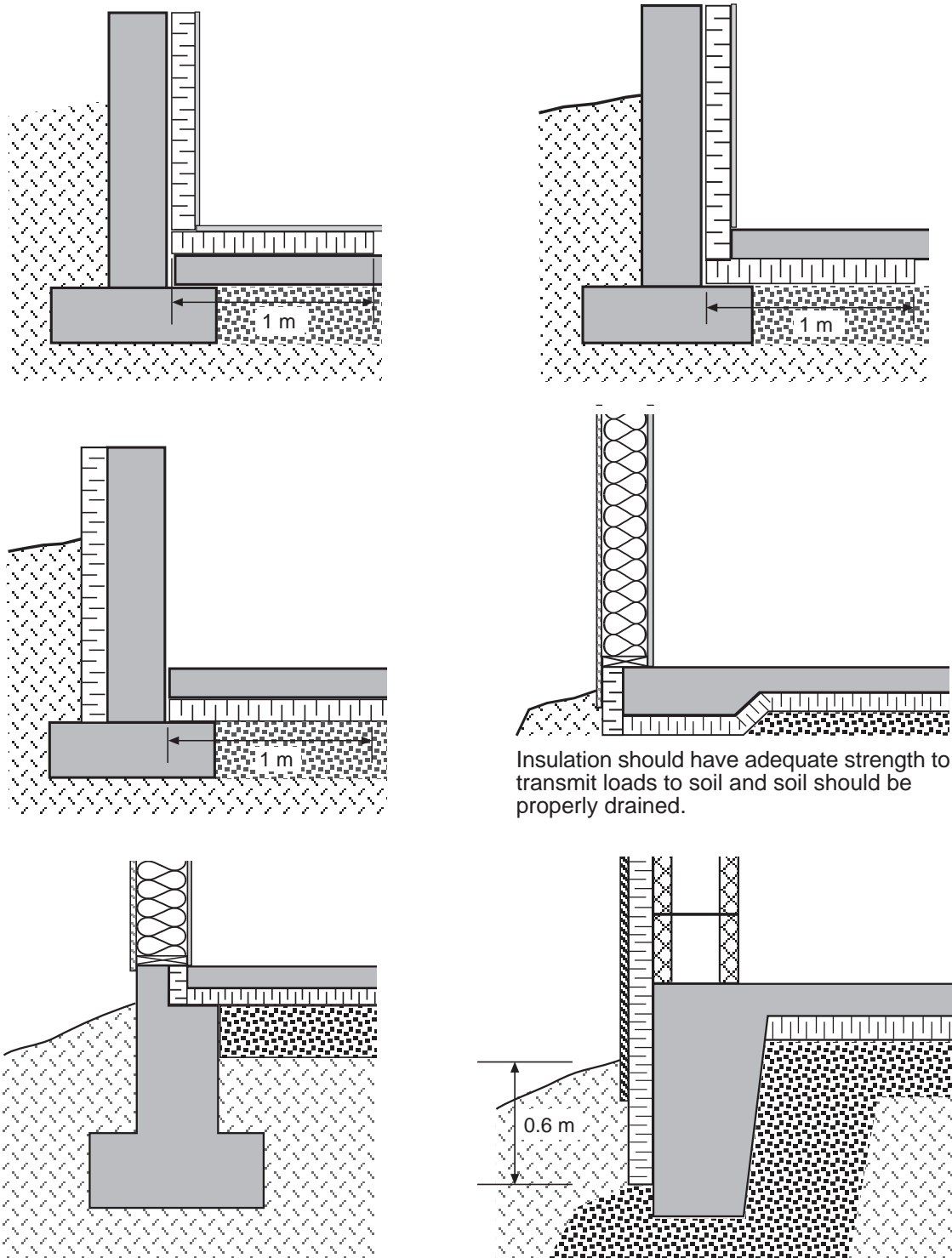

Figure E-3.2.3.3.

Insulation on Perimeter of Slabs on Ground at Walls

**E-3.2.4.3.(3) Other Doors.** This requirement applies to swinging, revolving and sliding doors.

**E-3.3.1.1.(1) Thermal Characteristics of Components of the Building Envelope.** The

overall thermal transmittance of a building assembly is the area weighted average thermal transmittance or U-value of the overall assembly, including insulation, sheathing, interior and exterior finish materials and air films, and taking into account thermal bridging due to framing members.

### E-3.3.1.1.(1)

Appendix B provides the user with a list of representative assemblies and their respective overall thermal transmittance. Appendix C explains how the effect of studs, plates, sills and lintels is taken into account in the calculation of the overall thermal transmittance and gives sample calculations. The U-value for above-grade walls also applies to the perimeter areas of intersecting interior walls and to the above-ground portion of foundation walls, except as provided in Sentence 3.3.1.1.(4).

**E-3.3.1.1.(3) Thermal Characteristics of Solid Masonry Walls.** In areas of low fuel costs and/or mild climates, solid masonry walls are exempted from the requirements of Sentence (1) and allowed higher U-values. Life-cycle cost studies have shown such walls to be cost-effective under certain conditions: when compared with leaving the masonry unfinished or finishing it with directly applied finishes that do not provide space for insulation, the added cost of introducing a finish material that creates a space to accommodate insulation (e.g. gypsum board on stud framing) cannot be paid back by the resulting energy savings in mild regions with low fuel costs.

However, it should be noted that there are limitations to the use of solid masonry walls without added finishes. Part 5 of the NBC requires building assemblies forming part of the building envelope to control air leakage and vapour diffusion and specifies limits on the rate of air leakage and vapour diffusion. Part 5 also requires building envelope assemblies to provide protection from ingress of precipitation. Exceptions are permitted only where it can be shown that uncontrolled or higher rates of air leakage or vapour diffusion, or ingress of precipitation, will not adversely affect the health and safety of building users, the intended use of the building or the operation of building services. It is generally recognized that these exceptions to the requirements of Part 5 of the NBC would normally apply only to warehouses and industrial buildings. There are few, if any, other building categories where air barrier systems, vapour barriers and resistance to precipitation ingress are not important. Solid masonry walls, without additional finishes to improve their air, vapour and moisture characteristics, will generally be restricted to warehouse and industrial buildings.

The maximum conductivity required for the insulation material corresponds to that of vermiculite, allows for such usual materials as perlite and foamed inserts and results in an overall thermal transmittance (U-value), depending on block type and thickness, of between 2.5 and 0.57 W/m<sup>2</sup>·°C.

**E-3.3.1.1.(5) Thermal Characteristics of Components with Embedded Radiant Heating.** This provision applies to insulated walls and top-storey ceilings under a roof or unheated attic space that have radiant heating equipment

embedded in them. The thermal resistance of a wall or ceiling behind radiant heating cables, pipes or membranes is increased in order to counteract the increased heat loss that would occur due to the increased temperature of the interior surface. Below-ground walls incorporating radiant heating are covered under Sentence 3.2.3.2.(2). Slabs on ground incorporating radiant heating equipment are covered under Article 3.2.3.3.

**E-3.3.1.2.(2)(b) Application to Small Skylight Areas.** This requirement corresponds to a double-glazed window in a thermally-broken aluminum frame.

**E-3.3.1.2.(3) Application to Sliding Glass Doors and Revolving Doors.** This exclusion only means that automatic sliding glass doors and revolving doors need not meet the requirement of Sentence 3.3.1.2.(1); their glazed areas must, however, be counted as part of the area of fenestration, as required by Sentence 2.2.2.8.(4).

**E-3.3.1.3.(1) Glazing Categories for Doors.** Glazing categories for doors are described in Table 1 of CSA Standard A453 according to size of glazing (glazing area refers to the outside dimensions of the glazing, including portions of the glazing that are embedded in the framing); Table 1 from CSA Standard A453, 1995 edition, is reproduced below for convenience (later editions may vary and should be followed):

Table E-3.3.1.3.  
CSA Standard A453, Table 1  
Reference Glass Sizes for Swinging Doors

Glazing Category	Minimum Area, m <sup>2</sup>	Maximum Area, m <sup>2</sup>
No Glazing	0	< 0.01
Minimal Glazing	0.01	< 0.12
1/2 Glazing	0.12	< 0.60
Full Glazing	0.60	-

**E-3.3.1.3.(4) Application to Swinging Glass Doors.** This exclusion only means that swinging glass doors need not meet the requirement of Sentence 3.3.1.3.(1); their glazed areas must, however, be counted as part of the area of fenestration, as required by Sentence 2.2.2.8.(4).

**E-3.3.1.4.(1) Effect of an Unconditioned Space.** This allowance is intended to provide an easy credit under the prescriptive path for any unheated space that may protect a component of the building envelope, that is, technically, for a space that is heated indirectly only. As such, it is

conservative. It does not take into account the construction of the enclosure of the unheated space; without any control on the construction of the unheated space, too many variables, such as its size or airtightness, may negate any higher credit that could be allowed. There may be simulation tools that can be used under the performance path to provide a better assessment of the effect of an indirectly heated space; this may be used to advantage when an unheated space is designed to provide protection significantly better than the worst-case situation assumed here.

Vented spaces, such as attic and roof spaces or crawl spaces, are considered to be part of the exterior space; therefore, the provision of Article 3.3.1.4. must not be applied to them in calculating the thermal transmittance of the assemblies they enclose.

**E-3.3.2.1.(1) Spaces Heated to Different Temperatures.** This requirement applies, for example, to walls or floors that separate spaces, one of which is heated to a normal comfort temperature and the other of which is heated to a significantly lower temperature and kept floating above that point. This would be the case of a wall between an office block and an attached warehouse that is heated just to keep it above freezing.

**E-3.4.1.1.(6) Limits to Trade-offs and to the Performance Path Regarding Mandatory Provisions.** There are several reasons why mandatory provisions are not subject to trade-off calculations or the performance path. In some cases, the energy-conserving impact of mandatory provisions cannot be easily quantified and allowing trade-offs would be unenforceable: this is the case, for instance, for airtightness requirements (Subsection 3.2.4.); similarly, for foundation walls and floors (Subsection 3.2.3.), energy losses below grade are difficult to assess and the algorithms used in trade-off software do not address below-grade heat losses satisfactorily. In other cases, it is a question of common sense: there should be no credit given for avoiding a local condition where a reduced performance is allowed for purely practical reasons, such as for beams and columns that run parallel to the building envelope and partly cut into the insulation (Sentence 3.2.1.2.(3)), where the allowance is given to avoid unwarranted hardship in detailing and construction. Other mandatory provisions simply do not lend themselves to trade-offs.

**E-3.4.1.2.(1) Treatment of Additions.** The trade-off path cannot be used to allow the upgrading of existing components of the building envelope to compensate for components of the addition that do not satisfy the prescriptive requirements of this Code; for example, taking advantage of new windows that are replacing existing ones. Thus, even if windows in the existing

building are to be upgraded at the same time as the addition is built, the new characteristics of the existing windows cannot be used in the trade-off calculations described in Sentences 3.4.2.1.(1) and 3.4.3.1.(1).

However, the provision of Sentence 2.2.2.8.(6) that permits averaging the window-to-wall ratio over the entire building — including existing and added portions' parts — may be used to determine the window-to-wall ratio for the addition.

**E-3.4.3.1.(1) Solar Heat Gains and Thermal Mass in Computer-assisted Trade-offs.** The computer-assisted trade-off path provides some means of taking into account the effects on energy consumption of such factors as solar heat gains and thermal mass of the building in order to gain some relaxation of the prescriptive requirements. The details and limitations as to how these are to be taken into account are described in the publication "Trade-off Compliance for Buildings, Specifications for Calculation Procedures for Demonstrating Compliance to the Model National Energy Code for Buildings Using Trade-offs," referenced in Sentence 3.4.3.3.(1).

**E-3.4.3.1.(2) Limitations to Computer-assisted Trade-offs.** This limitation is necessary because accounting for solar gains through sloped or horizontal surfaces would require much more complex software. Cases subject to this limitation can be pursued using the performance compliance path described in Part 8.

**E-4.1.1.1.(2) Application.** The application of the lighting requirements of this Code may adversely affect the use of spaces with special functional requirements. In these cases, some exceptions to the Code requirements may be necessary. Except for particular types of process lighting, however, it is unlikely that a space or lighting system would be exempt from all the requirements of this Part. Some necessary exceptions to particular requirements are identified in the Code. Exemption should be determined on an individual case-by-case basis, depending on the space function, available technologies and cost-effectiveness.

## **E-4.2.1. Exterior Lighting Power**

### **Limits, Allowances and Trade-offs**

Two approaches are used to specify ceilings on installed lighting power: allowances and limits.

In the case of limits, the specified value applies to the lighting identified in the requirement and no trade-offs are permitted with other types of lighting or lighting of other spaces. The limit for facade

## E-4.2.1.

lighting, for example, applies only to facade lighting. If the facade is not lit or the installed power is less than the limit, the remaining power cannot be applied to other lighting.

Where lighting power allowances are provided, the installed power may be traded off among the identified types of lighting or spaces lit, provided the total installed power does not exceed the total of the allowances for those types of lighting or spaces lit. This is similar to the simple trade-offs of building envelope insulation as provided in Subsection 3.4.2.

In the case of entrance and exit lighting, the allowances are applied to each entrance and exit in the building and added together for a total allowance. The actual installed power at any particular entrance or exit may exceed the allowance for an entrance or exit, provided the total installed power for all the entrances and exits does not exceed the total allowance.

Trade-offs generally apply to a single building. For entrance and exit lighting, however, an exception is provided to permit trade-offs between buildings when two or more buildings are being built together. As this Code applies only to new construction, this exception cannot be applied to a separate existing building on the same site. Where the building permit is for an addition, a variety of characteristics of the parent building are necessarily addressed by the building permit; to this extent, trade-offs between the addition and the existing building are permitted. For example, if the total lighting power for the exterior entrances of an existing building is less than the allowance for those entrances, the remainder may be applied to increase the lighting power at an entrance to an addition to that building.

### Lighting Levels and Safety

Applying current technology, the exterior lighting efficacy limits and entrance and exit power allowances will not reduce lighting to a level that would generally affect safety. Uniformity of lighting, rather than light level, is more critical to safety. Exceptions allowed under Sentence 4.2.1.2.(2) will accommodate exceptional cases.

### High Reflectance Paving and Illumination Levels

ANSI/IESNA RP8-1983 (R1993), "Recommended Practice for Roadway Lighting," recognizes that the reflectance of paved surfaces has a significant effect on the lighting power necessary to achieve required levels of illumination. The use of reflective paving should be considered as a possible alternative to the installation of more lighting fixtures or higher-powered lamps.

#### E-4.2.2.1.(2)(b) Exterior Lighting Controls for Sports Facilities.

Although compliance with

the exterior lighting control requirements would not adversely affect the use of an outdoor sports facility, the schedule of space use may be so irregular that the installation of these controls would not lead to energy savings.

#### E-4.2.3.2.(1) Lighting within Dwellings.

Research indicates that the installation of high-efficacy (non-incandescent) lighting in dwellings is cost-effective and should be encouraged. High-efficacy fixtures and lamps are available that provide high-quality lighting.

The capital cost of these high-quality units, however, is higher than that of commonly installed incandescent units, and discourages their installation. Evidence indicates that where high-efficacy units have been required by codes, the installed units would often be of lower initial cost and provide comparably lower lighting quality. These would then be replaced at a later date with low-efficacy and low-cost fixtures that provided better lighting quality.

Until this implementation and enforcement issue can be resolved, a requirement for high-efficacy lighting cannot be expected to be effective.

#### E-4.2.4. Interior Lighting Controls.

Although installation of automatic controls to the exclusion of other control devices is not mandatory in this Code, and although the installation of additional controls to reduce lighting and to take advantage of daylighting is not required by the Code, such installations are to be encouraged because, properly installed and operated, they provide additional potential for energy savings.

##### E-4.2.4.1. Circuit Breakers as Controls.

The use of circuit breakers as the required manual control is not precluded by this Code but is not encouraged. Section 30 of the Canadian Electrical Code, Part 1, contains specific requirements for the use of circuit breakers as switching devices.

##### E-4.2.4.2. Controls for Night Lights.

Night lighting is not to be confused with emergency lighting. Emergency lighting is powered and controlled separately from normal space or task lighting and is often not activated until there is a power failure; as such it cannot be used by building occupants in non-emergency situations. Fixtures that provide emergency lighting are often in addition to and of a different type compared to those that provide space or task lighting.

Fixtures that provide night lighting in office spaces are intended to be the same fixtures that provide lighting during normal hours of use. Some of these fixtures, however, are to be provided with separate controls. This allows building users to activate these

fixtures to provide minimum lighting levels at night in spaces between elevator lobbies or stairs and task areas. In providing user-activated controls for fixtures spaced at a specified density, low-level lighting can be provided as needed for safe travel to the task area; higher-level lighting normally required to work in the intervening areas can be left off.

The application of the requirement to areas with a connected lighting density of more than 12 W/m<sup>2</sup> ensures that the controls will be installed in office work areas but need not be installed in, for example, customer or lobby areas, or dead-file storage rooms. Spaces smaller than 40 m<sup>2</sup> are exempt because the installation of wiring and controls for the night lights is less cost-effective (see also Appendix note E-4.2.4.3.(4)).

**E-4.2.4.3.(2)(c) Location of Controls Operated by Staff.** For some public spaces where controls are intended to be operated by staff, consideration should be given to locating the controls at the principal staff entrance to the space rather than in a remote location. This entrance may or may not be the principal public entrance to the space.

**E-4.2.4.3.(4) Location of Night Light Controls.** Consistent location of night light controls as the first switches in a bank of controls will encourage their use.

**E-4.2.4.4.(1) Master Switches in Guest Rooms and Suites.** For the purpose of this requirement, a guest room or suite is intended to include all areas under control of the guest and may include hallways, kitchens, bathrooms, sleeping spaces, etc.

**E-4.2.6.1.(2) System Design and Operation.** Some of the information required may not be available at the time of application for permit, but may be identified in a list at that time; manufacturers' operational and maintenance manuals are one example of such information. This information should then be made available when collated, before the end of construction.

**E-4.3. Prescriptive Compliance.** The prescriptive criteria in Section 4.3. relate actual interior connected lighting load to a permitted interior lighting power allowance. Two methods for calculating the interior lighting power allowance (ILPA) are provided.

The simple calculation procedure in Subsection 4.3.2. is based on building type only and has limited accuracy or flexibility. The criteria are not sensitive to specific task and room configurations that affect lighting power in any particular building.

The alternate calculation method in Subsection 4.3.3. provides greater flexibility and a more accurate and

detailed calculation procedure, which is usually desirable for buildings with multiple spaces and activities.

For maximum flexibility in design, the performance path, described in Section 4.4. and Part 8, may be followed in lieu of the prescriptive requirements.

These procedures are not to be used as lighting design procedures. Once the ILPA for the building has been determined, the designer should strive to design a lighting system that will provide an effective and pleasing visual environment without exceeding the ILPA or reducing the level of control.

**E-4.3.1.2. Credits toward the Interior Connected Lighting Power Limit.** Unlike the ASHRAE/IESNA Standard 90.1-1989, "User's Manual," no credit toward the interior connected lighting power limit is provided for the use of any controls, automatic or otherwise.

**E-4.3.1.2.(2)(a) Task Lighting.** Installation of high-efficacy task lighting has proven to be cost-effective and is to be encouraged.

**E-4.3.1.2.(2) Connected Lighting Power.** Where the ILPA includes an allowance for a particular space, the ICLP must also include a value for connected lighting power (CLP) for that space. Recognizing that moveable plug-in units are moved, plugged in, unplugged and easily replaced over time, the CLP for moveable and plug-in luminaires is not intended to reflect the actual CLP of these units over the life of the space. Rather, it is to indicate a power level that will support a lighting level appropriate for the initial intended use of the space. Thus, where the design calls for moveable or plug-in luminaires, the designer must select a sufficient quantity and quality of luminaires to provide the necessary light and a lighting power level must be specified to reflect the installation of those units.

**E-4.3.2. Calculation of Interior Lighting Power Allowance by Building Type.** Article 4.3.1.1. requires that calculation of ILPA be done in compliance either with this Subsection or with Subsection 4.3.3., Calculation of Interior Lighting Power Allowance by Space Function.

**E-4.3.2.1.(1) Application of the Interior Lighting Power Allowance Calculation by Building Type.** Calculation of ILPA<sub>BT</sub> may not be applied to additions to an existing building, or to fit-up individual spaces within an existing building.

**E-4.3.2.1.(5) Lighting Power Allowances for Multi-Use Buildings.** Where a building that is principally an office building, for example, contains other types of spaces listed in Table 4.3.2.1.,

## E-4.3.2.1.(5)

such as parking, storage or retail space, and any of those areas exceed 10% of the lighted area of the whole building, the ILPA for the building will be the sum of the allowances for the individual areas.

**E-Table 4.3.2.1. Lighting Power Density by Building Type.** Consistent with the requirements for calculating ICLP, the  $LPD_{BT}$  for retail buildings excludes lighting for display cases; the  $LPD_{BT}$  for storage garages includes lighting for parking, driving and pedestrian walking areas.

**E-4.3.3. Calculation of Interior Lighting Power Allowance by Space Function.** Article 4.3.1.1. requires that calculation of ILPA be done in compliance either with this Subsection or with Subsection 4.3.2., Calculation of Interior Lighting Power Allowance by Building Type.

### E-Table 4.3.3.4. Lighting Power Densities by Space Function

#### Restaurants

Fast food/cafeteria establishments include all retail food and beverage service establishments where orders are placed and paid for at a counter and the customers' selections are taken to a table or carried out. Leisure dining establishments include food and beverage establishments where the customers' orders are taken and served by staff at the customers' table.

#### Retail Establishments

$LPD_{SF}$  for retail buildings excludes lighting for display cases. Retail categories are as follows:

- Jewellery merchandising: where minute examination of displayed merchandise is critical,

- Fine merchandising: fine apparel/accessories, china, crystal, silver, art galleries, etc., where detailed display and examination of merchandise is important,
- General merchandising: general apparel, variety, stationery, books, sporting goods, hobby, cameras, gifts, luggage, etc., displayed in department store-type of building where focused display and detailed examination of merchandise is important,
- Mass merchandising: general apparel, variety, stationery, books, sporting goods, hobby, cameras, gifts, luggage, etc., displayed in warehouse-type building, where general display and examination of merchandise is adequate,
- Food and miscellaneous: bakeries, hardware and housewares, grocery, appliances and furniture, etc., where appetizing appearance is important, and
- Service establishments: establishments where functional performance is important (see definition, Part 1).

#### Storage Garages

$LPD_{SF}$  for *storage garages* includes lighting for parking, driving and pedestrian walking areas.

#### Cleaning

$LPD_{SF}$  includes lighting installed for cleaning purposes.

**E-4.3.3.5.(1) Determination of Area Factor.** The graphs in Figure E-4.3.3.5.(1) represent the equation provided in Sentence 4.3.3.5.(1) and may be used in lieu of calculation to determine area factor.

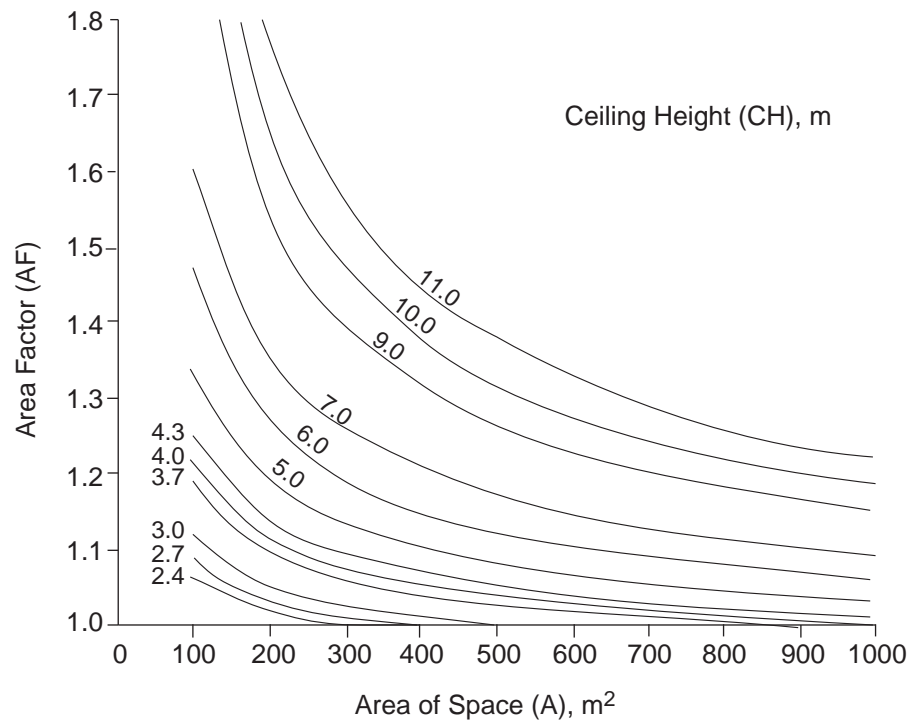
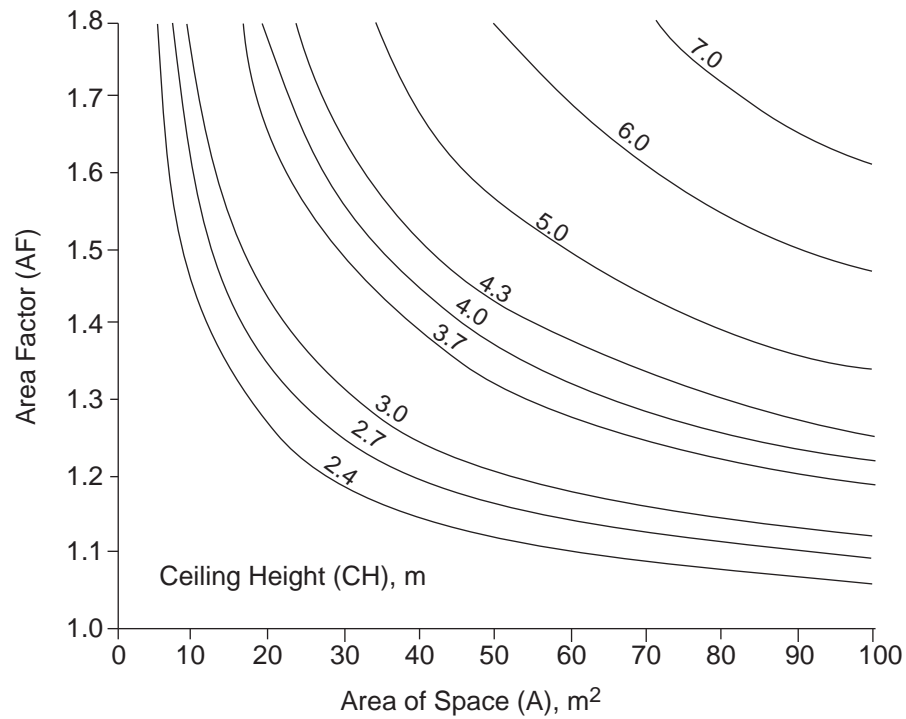

Figure E-4.3.3.5.(1)  
Area Factor Curves

**E-4.3.3.6.(3) Indoor Sports Areas.** Refer to IESNA-RP-6-88, “Current Recommended Practice for Sports Lighting,” for definitions of playing boundaries.

**E-5.1.1.1.(2) Exceptions.** Since any list of exceptions would necessarily be incomplete, a general statement is provided in this Code and examples appear in this Appendix note. Examples of exceptions are:

## E-5.1.1.1.(2)

- buildings or rooms in which the processes or activities call for temperature or humidity conditions outside the normal range required for comfort, and
- heating equipment that uses solar energy or energy recuperated from process operations as its sole source of heating energy; such equipment may be exempted from the requirements in this Part for equipment energy-efficiency.

**E-5.2.1.1.(1) Load Calculations.** The ASHRAE 1997 Handbook — Fundamentals and, for smaller buildings, the HRAI Digest are useful sources of information in this field.

**E-5.2.2.1.(1) Design and Installation of Ducts.** The following publications are a useful source of information in this field:

- Publications by ASHRAE:
  - the ASHRAE Handbooks.
- Publications by SMACNA:
  - HVAC Duct Construction Standards — Metal and Flexible,
  - Fibrous Glass Duct Construction Standards,
  - HVAC Systems — Duct Design,
  - HVAC Air Duct Leakage Test Manual.

**E-5.2.2.2.(1) Provision for Balancing.** Balancing a distribution system provides a means of fine-tuning it so that the correct amount of air for which the heating, ventilating or air-conditioning system is designed can be delivered. Except for systems having some other means of air-volume control (such as variable air-volume systems), major supply air ducts such as main, sub-main or branch ducts intended to carry conditioned air must contain air-volume balancing dampers capable of setting specified air flows.

The “Technician Training Manual” from the Associated Air Balance Council, 1518 K Street, NW, Washington, DC 20005 U.S.A, is a useful source of information in this field.

**E-5.2.2.3.(2) SMACNA Duct-Sealing Classification.** An outline of the SMACNA sealing classification and its relationship to SMACNA static pressure classification, as given in SMACNA HVAC Duct Construction Standards — Metal and Flexible, 1985 edition, is reproduced in Table E-5.2.2.3.(2) for convenience (later editions may vary and should be followed):

**Table E-5.2.2.3.(2)**  
**SMACNA Duct Sealing Classification**

Static Pressure Class	Seal Class	Description
≤ 2	C	Sealing required at transverse joints
> 2 and < 4	B	Sealing required at all transverse joints and longitudinal seams
≥ 4	A	Sealing required at all transverse joints, longitudinal seams and duct wall penetrations

**E-5.2.2.3.(4) Exceptions to Duct Sealing Requirements.** This exemption does not apply to ducts in ceiling plenums or other service spaces that are immediately adjacent to the conditioned space served by the ducts.

The rationale for Sentence (4) is that if a duct is located in the same space to which it is supplying air, then there is no energy penalty should a little of the same supply air leak into the space before it gets to the diffuser. This might not exactly be the case if there is some controlled element, such as a coil or damper, between the leak and the diffuser. However, because of the way “supply duct” is defined, the controlled element would be limited to something such as reheat coils, mixing boxes or variable-air-volume boxes; major heating or cooling coils would not be in supply ducts. Therefore, the energy penalty for such leaks in the supply duct would not be large.

**E-5.2.2.4.(1) Duct Leakage Testing.** The choice of ducts to be tested is left in this case to the inspector, all ducts being subject to testing.

**E-5.2.4.2.(1) Provision for Balancing.** Balancing a hydronic system provides a means of fine-tuning it so that the correct amount of fluid for which the system is designed can be delivered to each of the sectors served. Pumps and major circuit divisions must be installed with adequate access to the fluid to measure differential pressure or flow, and must contain means of adjusting the flow.

The following publications are a useful source of information in this field:

- Publications by ASHRAE:
  - ANSI/ASHRAE 111-1988 Standard, “Practices for Measurement, Testing, Adjusting and Balancing of Building Heating, Ventilation, Air-Conditioning and Refrigeration Systems”,
  - the ASHRAE Handbooks.

- Publications by the National Environmental Balancing Bureau, 8575 Grovemount Circle, Gaithersburg, Maryland 20877 U.S.A.

#### **E-5.2.5.2.(1) Variable-Flow Pumping Systems.**

Flow may be varied by one of several methods, including (but not limited to) variable-speed-driven pumps, staged multiple pumps or pumps riding their characteristic performance curves. This requirement reduces the use of three-way valves.

#### **E-5.2.8.1.(1) Insulation Behind Recessed Heaters.**

This article does not apply to components of a heater that penetrate through the building envelope, such as a ducted air intake or exhaust, or to a through-the-wall unit. However, it does apply to the components of the heater that do not need to penetrate to the outside, and to any piece of equipment that is merely recessed into the wall, ceiling or floor for the sake of reducing its projection into the room.

#### **E-5.2.10.4.(1) Mounting Height and Location of Thermostats**

##### **Mounting Height of Thermostats**

Article 3.8.1.5. of the National Building Code of Canada has a specific requirement for the mounting height of thermostats located in a barrier-free path of travel. It may be convenient to use thermostats in which the sensing device is separate from the control portion.

##### **Location of Thermostats**

Locations to be avoided are exterior walls and locations near exterior entrances, corners or heat sources; within throw of supply air diffusers; or in direct sunlight. Installation should include all necessary settings and adjustments, including, in the case of electrical heaters, setting of the heat anticipator to match the capacity of the heaters being controlled, as required on some thermostats for performance certification.

**E-5.2.10.6.(2)(a) Space Temperature Control for Perimeter Systems.** This prohibits the use of an outdoor sensor as the sole control to determine the heat supplied to the space, but permits control of radiation for the entire exposure from a single zone thermostat.

#### **E-5.2.10.6.(3) Heating/Cooling Controls.**

This could be by means of software in a Direct Digital Control system, or by provision of a concealed, adjustable mechanical stop in each thermostat.

**E-5.2.12.1.(1) Off-hours Controls.** For a system serving only a single dwelling unit, one way

to satisfy this requirement is to use an automatic programmable thermostat that permits automatic setback of the thermostat setpoint. For larger buildings with more than one system, a central control is recommended.

**E-5.2.12.1.(2)(e) Heat Pump Controls for Recovery from Setback.** Several techniques of achieving this exist:

- a separate exterior temperature sensor,
- a gradual rise of the control point,
- controls that ‘learn’ when to start recovery from previous experience.

**E-5.2.12.2.(1) Air Flow Control Areas.** There are a number of different ways of complying with Sentence 5.2.12.2.(1):

- use smaller systems, serving less than 2500 m<sup>2</sup>,
- use direct digital control for variable-air-volume boxes, and program these to shut off completely (variable-air-volume systems do not necessarily comply with this requirement)\*,
- use direct digital control for variable-air-volume boxes, and program these to shut off completely (variable-air-volume systems do not necessarily comply with this requirement)\*.

\*Note that, in the latter two approaches, systems must be designed so they can operate at the low flows resulting from only one of the air flow control areas being in operation.

**E-5.2.12.2.(2) Temperature Control for Air Flow Control Areas.** The intent is that one should not have to condition all of the zones when only some are occupied. One should be able to isolate at least each floor; where the floor surface area exceeds 2500 m<sup>2</sup>, it should be divided into areas not greater than 2500 m<sup>2</sup>.

#### **E-5.2.13.1.(1) Unit and Packaged Equipment.**

Table 5.2.13.1. refers to accepted values in energy-efficiency acts and in Canadian standards where available; otherwise, values from tables in ASHRAE/IESNA Standard 90.1-1989, “User’s Manual” are used where appropriate. In order to reduce duplication and conflicts between requirements, minimum performance values are omitted from the Table and noted as being “in the standard” wherever the referenced standard itself contains such minimum performance requirements, since these standards are used in the federal, provincial and territorial energy-efficiency acts and could be changed on a different schedule.

For units of equipment subject to federal, provincial or territorial appliance or equipment energy-efficiency acts, a label on the appliance certifying the unit’s performance according to the standard is proof that it meets the requirements of the standard

## E-5.2.13.1.(1)

and of the acts; there is therefore no need for figures to be checked.

It should be noted that, where a building is served by multiple heating or cooling units that are activated in sequence in response to increasing heating or cooling needs, it is likely economically justified to specify higher efficiency than is mandated in this Code for the lead units, which operate for the longest periods of time.

**E-5.2.14.1.(2) Statement of Design Intent and Operational Recommendations.** In order to help building managers operate the building in an energy-efficient way, instructions for balancing, commissioning and testing the systems should be provided, together with operation and maintenance manuals.

**E-5.3.1.1.(2) Fan System Design.** Although the allowed maximum power demand is based on only the supply air flow, the fans to be included in calculating the actual power demand include supply fans, return fans, relief fans, and fans for series fan-powered boxes, but not parallel-powered boxes or exhaust fans such as bathroom or laboratory exhausts.

**E-5.3.1.2.(1) Constant-volume Fan Systems.** This type of system includes bypass variable-air-volume systems in which the flow through the fan is not varied.

Both supply and return fans must be accounted for, but not exhaust fans.

The power demand of the motors is the power drawn by the motors and not their nameplate rating.

**E-5.3.1.3.(1) Variable-air-volume Fan Systems.** Supply, return and relief fans must be accounted for, but not exhaust fans.

Fans for series-fan-powered boxes must be accounted for, but not the fans in parallel-fan-powered boxes.

The power demand of the motors is the power drawn by the motors and not their nameplate rating.

**E-5.3.2.2.(2) Outdoor Air Flow for Acceptable Air Quality.** Outdoor air requirements for acceptable indoor air quality are covered by Part 6 of the National Building Code of Canada.

**E-5.3.3.1.(2) Reheating the Supply Air for Humidity Control.** This could apply to spaces such as computer rooms and museums. Theatres often require reheating since the cooling coil discharge temperature necessary to maintain reasonable humidity levels is too low for adequate comfort conditions.

**E-5.3.4.1.(1) Heat Recovery from Dehumidification in Swimming Pools.** It is not intended that all exhaust air from the swimming pool area must pass through a heat recovery unit, provided that 40% of the total sensible heat is recovered. Most heat recovery units can recover more than 40% of the sensible heat from the exhaust air, but because it may not be cost-effective to reclaim heat from all exhaust systems, the overall recovery requirement was set at 40%.

**E-5.3.4.2.(1) Heat Recovery from Ice-making Machines in Ice Arenas and Curling Rinks.** Heat recovered from refrigeration equipment can be used for space heating, service water heating or heating the soil beneath the ice surface to prevent frost heave.

**E-5.3.4.3.(1) Heat Recovery in Dwelling Units.** The National Building Code of Canada (NBC) 1995 includes detailed requirements for the mechanical ventilation of dwelling units. However, as the NBC is concerned only with health and safety issues, those requirements address only the effectiveness of ventilation systems, not their efficiency, which is left to this Code. Therefore, the requirements of this Code should be read in conjunction with those of the NBC. For example, the requirements in NBC 1995, Subsection 9.32.3., Mechanical Ventilation, can be satisfied using a heat-recovery ventilator but can also be satisfied with other types of ventilation equipment. In cases where this Code requires heat recovery from the exhaust component of the ventilation system, a heat-recovery ventilator would probably become the system of choice.

The principal exhaust component of a mechanical ventilation system is described in Article 9.32.3.4. of the NBC 1995 and represents 50% of the total ventilation capacity required by Article 9.32.3.3. of that Code.

**E-5.3.4.3.(2) Heat Recovery Ventilators.** The referenced CSA Standard, CAN/CSA-C439, describes a laboratory test that determines the energy performance of a heat-recovery ventilator. The results of a test made for a manufacturer on a given model is listed in the Certified Home Ventilating Products Directory of the Home Ventilating Institute, Division of Air Movement and Control Association, 30 West University Drive, Arlington Heights, Illinois 60004-1893 U.S.A. and usually appears on a label on the equipment itself or in the manufacturer's published literature.

**E-6.1.1.1.(2) Exceptions.** Since any list of exceptions would necessarily be incomplete, a general statement is provided in this Code and examples given in this Appendix note. One possible exception is:

- service water heating equipment that uses solar energy or energy recuperated from process operations as its sole source of heating energy; such equipment may be exempted from the requirements for equipment energy efficiency.

**E-6.2.1.1.(1) System Design.** The following documents are useful sources of information in this field:

- National Plumbing Code of Canada, published by NRC,
- 1995 ASHRAE Handbook, HVAC Applications,
- American Society of Plumbing Engineers (ASPE) Data Book Volume 1, Fundamentals of Plumbing Design, chapters on Service Water Heating Systems and on Energy Conservation in Plumbing Systems, available from ASPE at 3617 Thousand Oaks Boulevard, Suite 210, Westlake, California 91362, U.S.A., and
- the appropriate provincial and local plumbing codes.

**E-6.2.2.1.(1) Equipment Efficiency.**

Table 6.2.2.1. refers to accepted values in energy-efficiency acts and in Canadian standards where available; otherwise, values from tables in ASHRAE/IESNA Standard 90.1-1989, “User’s Manual”, are used where appropriate. In order to reduce duplication and conflicts between requirements, minimum performance values are omitted from the Table and noted as being “in the standard” wherever the referenced standard itself contains such minimum performance requirements, since these standards are used in the federal, provincial and territorial energy-efficiency acts and could be changed on a different schedule.

For units of equipment subject to federal, provincial or territorial appliance or equipment energy-efficiency acts, a label on the appliance certifying the unit’s performance according to the standard is proof that it meets the requirements of the standard and of the acts; there is therefore no need for figures to be checked.

**E-6.2.3.1.(1) Heat Traps.** ASHRAE/IESNA Standard 90.1-1989, “User’s Manual” defines a heat trap as follows: “A heat trap may take the form of a bent piece of tubing which forms a loop of 360°; an arrangement of pipe fittings, such as elbows, connected so that the outlet and inlet piping make vertically upward runs just before turning downward to connect to the water heater’s inlet and outlet fittings; a commercially available heat trap; or any other type that effectively restricts the natural tendency of hot water to rise in the vertical pipe during standby periods (see diagrams below).

“When the water heater outlet is directly horizontal out of the tank or is piped with an elbow on the vertical outlet and then downward, this piping arrangement itself is effectively a heat trap and a

separate heat trap is not then needed.”

Figure E-6.2.3.1. illustrates two examples of site-built heat traps. An inlet pipe that feeds directly into the cold region of the tank may also be considered to have an effect equivalent to that of a heat trap.

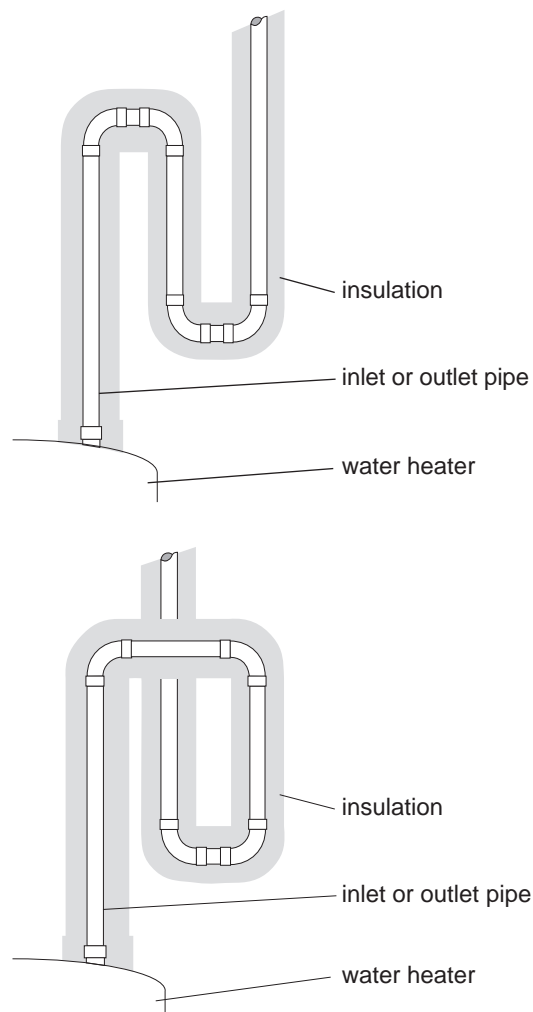

Figure E-6.2.3.1.  
Heat Traps

**E-6.2.4.1.(1) Temperature Control.**

Temperatures for various uses can be found in Table 3, Chapter 54 of the 1995 ASHRAE Handbook, HVAC Applications.

**E-6.2.4.2.(1) Shutdown.** This is intended for seasonal or long-term shutdown. For electrical water heaters, a breaker approved for use as a disconnect and installed in the distribution panel can act as the shut-off device required by this article. For gas water heaters, a down position on the temperature control, which sets the heater to standby with only the pilot light running, meets this requirement.

**E-6.2.5.1.(1) Remote or Booster Heaters.**

This is intended for dishwashers, etc. The intent is

## E-6.2.5.1.(1)

that the general supply temperature not be raised to meet these requirements.

**E-6.2.6.1.(1) Flow-restricting Shower Heads.** Flow-restricting inserts should not be used to meet this requirement. A flow of 9.5 L/min is equivalent to 2.5 US gal/min.

**E-6.3.1.1.(1) Combining Service Water Heating with Process Water Heating.** This does not preclude combining service water heating with process water heating.

### E-7.2.1.1.(1) Metering

#### Metering and Billing

Monitoring energy consumption is considered essential to energy management. Individual metering to billing accuracy is intended to provide the building owner and tenant with a means to monitor consumption. This requirement does not necessarily imply individual billing by the distributor, but is intended as a monitoring tool that could also be used for the distribution of costs where billings are not individual.

#### Stack Effect and Heating Costs

The phenomenon of stack effect results in cooler air being drawn in on the lower floors of buildings and warmer air exfiltrating from the upper floors. The effect increases with the height of the building and the temperature difference between the inside and outside of the building. The result in the heating season is that more heat is required to maintain temperatures on the lower storeys than on the upper storeys. In the cooling season, more energy is required to cool the upper floors compared to the lower floors. Where metered energy consumption is used for billing purposes, one possible solution would be to use the average for all floors as a base cost. Discrepancies in billing would occur only where a suite uses more or less energy than other suites on the same floor.

**E-7.2.1.2. Means to Monitor Energy Consumption.** The provision of means to monitor energy consumption does not require the installation of monitoring equipment but, rather, provision of the necessary access and hardware to permit the installation and/or use of monitoring equipment, should the building owner so wish. This might include, for example, the installation of a meter socket or the provision of access to the load side of the service box or main distribution panel to allow for the measurement of energy consumption using voltage and/or current transformers on a separately mounted meter or data logger. Requirements for safe access to metering locations are provided in local electrical codes and in Section 2 of the Canadian Electrical Code, available from CSA.

**E-7.2.1.2.(1) Monitoring Consumption in Office Spaces.** This requirement applies, for example, to:

- office floors of typical office buildings, where the floor surface area is at least 1000 m<sup>2</sup>,
- office floors of mixed-use buildings, such as those with retail outlet/business and personal service occupancies on the lower floors and offices above, where the floor surface area is at least 1000 m<sup>2</sup>, and
- floors of buildings that provide office space and other spaces, such as laboratory space, but where the floor surface area allocated to offices and office support space is at least 1000 m<sup>2</sup>.

### E-7.2.2.1. Power Controls

#### Power Receptacles

Controls are required for exterior power receptacles and for some receptacles serving parking spaces to allow switching of seasonal decorative lighting, block heaters, car warmers or other electrical devices. Controls for parking receptacles may include ambient temperature switches.

#### Exterior Receptacles

One exterior receptacle should be controlled so as to accommodate decorative lights.

#### Receptacles for Parking

As far as possible, where indoor or outdoor parking spaces are provided with receptacles, these should also be controlled to accommodate block heaters, car warmers and other electrical devices.

**E-7.2.5.1.(1) System Design and Operation.** Some of the information required may not be available at the time of application for permit, but may be identified in a list at that time; manufacturers' operational and maintenance manuals are one example of such information. This information should then be made available before the end of construction.

**E-8.2.1.3.(1) Solar Heat Gains and Thermal Mass in the Performance Compliance Path.** The performance path provides some means of taking into account the effects on energy consumption of such factors as solar heat gains, thermal mass of the building, and energy recovered from processes, in order to gain some relaxation of the prescriptive requirements. The details and limitations as to how these are to be taken into account are described in the referenced publication "Performance Compliance for Buildings, Specifications for Calculation Procedures for Demonstrating Compliance to the National Energy Code for Buildings Using Whole Building Performance."

**E-8.2.1.5. Treatment of Additions.** When the addition is considered by itself, its dimensions and thermal characteristics are used without regard to the existing building. The wall or floor or virtual plane separating the addition from the existing building is considered for what it is — a building component separating two conditioned spaces: no heat exchange is considered across it, unless the design calls for a temperature differential across it or the existing building is an unconditioned space. Only the new mechanical and electrical systems that are part of the addition or serve only the addition are considered in the calculations. Existing central plants are not considered.

When the addition is considered together with the existing building, energy analyses of the whole building are required, including existing parts and additions. Some existing parts of the building may not be needed for the comparison and may not have to be simulated; for example, existing central plants. It may be advantageous to consider the whole building only in cases where considering the addition by itself would result in a very high fenestration-to-wall ratio. Existing portions of the building need not be upgraded to code requirements; the software is expected to use the existing characteristics of the existing components in both the analysis of the building as proposed and the analysis of the reference building.

However, as implied by Clause 8.2.1.5.(1)(b), the performance path cannot be used to allow the upgrading of existing components of the building to compensate for components of the addition that do not satisfy the prescriptive requirements of this Code; for example, taking advantage of new windows that replace existing ones. Thus, even if the windows in the existing building are to be upgraded at the same time as construction of the addition, the characteristics of the existing windows will be used in both analyses. This results in no energy savings in the existing parts of the building that can offset any shortcomings of the addition's components.

The degree of precision required for determining the thermal characteristics of existing components, as required in Sentence 8.2.1.5.(2), is not high, since the characteristics of the existing parts of the building remain identical in both computer simulations. In fact, the existing parts of the building get compared to themselves.



# Appendix F

## Determination of Regionally Sensitive Requirements

The predecessor to this Code, “Measures for Energy Conservation in New Buildings,” included tables of minimum thermal resistance values that varied according to climate as expressed in degree-days. However, although the derivation of those minimum values was based on life-cycle costing analyses, those analyses did not take into account other regional variations in the parameters that enter into such life-cycle costing. For instance, they used one value for the cost of energy, even though there is a significant variation in energy costs across the country and between different types of energy within a given region.

This Code includes many requirements that vary according to region — thermal transmittance values, minimum depth of foundation insulation, requirement for heat recovery from exhaust air, etc. The derivation of these requirements is also based on a life-cycle costing process. However, in this case, the life-cycle costing analyses took into account many more regionally sensitive variations in the life-cycle costing parameters.

The process used can be summarized as follows:

- (1) A number of commonly used building assemblies (walls, roofs, floors, etc.) were identified, their thermal transmittance values calculated, and their construction costs estimated.
- (2) The effect of varying the characteristics of one of these assemblies (such as the thermal transmittance of the walls) on the annual heating cost of a representative building was estimated using a computer simulation program.
- (3) For each assembly in a category (such as walls), its incremental cost relative to the lowest cost assembly of those studied was added to the present worth of the increment in annual heating costs that assembly causes relative to the assembly with the lowest thermal transmittance.
- (4) The assembly with the lowest sum of increment in cost plus increment in present worth of heating costs was identified as the apparent optimum assembly.

This process was carried out interactively with provincial and territorial officials, using their inputs on such parameters as present and future energy costs and the useful life of buildings. The thermal transmittance values of the apparent optimum

assemblies generated by this process were then proposed to these provincial/territorial officials as the likely choices for the maximum acceptable thermal transmittance values under this Code. Although these choices were sometimes tempered by practical considerations such as local building practices and available materials, the tables of regionally sensitive requirements in Appendix A are, for the most part, direct outcomes of this life-cycle costing process.

The four-point summary above is, of course, a gross simplification of a rather complex process, described in greater detail in the papers referenced at the end of this appendix. However, it may be helpful to Code users to know the provincial inputs on which the regionally sensitive requirements are based. These are included in Table F-2 at the end of this appendix. The following discussion on life-cycle costing is provided to aid in understanding the significance of these provincial inputs.

The concept of a present-worth factor,  $P_f$ , is best explained by an example. Suppose the annual cost of the heat loss through the building envelope were to increase according to the following schedule:

Years	Annual cost
1st year	\$500
+ 1 year	\$514
+ 2 years	\$528
+ 3 years	\$543
	⋮
+ 9 years	\$641
	⋮
+ 19 years	\$844
	⋮
+ 25 years	\$997
	⋮
+ 29 years	\$1114

It is possible to calculate a sum of money that, if deposited in a bank or invested in an annuity and withdrawn according to the above schedule to pay the annual heating costs, would just be consumed (both principal and interest) at the end of the period under consideration. This amount is called the

## Appendix F

present worth of those annual heating costs. It is calculated using the following equations:

$$PW = C \times \frac{1-(1+a)^{-n}}{a}$$

or

$$PW = C \times P_f$$

where

- PW = the present worth of the heating costs over n years,
- C = the annual heating cost in the first year,
- a = the effective interest rate,  
=  $(i - e)/(1 + e)$ ,
- e = the rate at which energy costs are expected to increase (including inflation),
- $P_f$  = the present worth factor,
- i = the discount rate or cost of money (including inflation), and
- n = the number of years under consideration.

These last two factors require further elaboration.

The discount rate can be a number of things. If the money were in fact deposited in a bank, the discount rate would be the interest rate offered by the bank. Another way to look at it would be to say that the cost of money is the interest that would be paid on the best investment an owner could make with the same amount of money if he or she did not invest in an energy-conserving option.

The number of years to be considered is equally difficult to decide upon. It might be the amortization period of a mortgage or other form of financing. However, it can be argued that it should be the life of the building, which might exceed 100 years. It can also be argued that many owners are unwilling to look beyond 10 years, so this timeframe should be used. Perhaps it is reasonable to use the economic life of the building — that period over which the building is likely to remain useful without major renovations. This is about 20 to 30 years, in most cases.

### Example

The schedule of annual heating costs in the example above is based on an energy cost increase rate of 2.8%, which might represent a rate of increase 0.1% below a general inflation rate of 2.9%. Assume the cost of money is 3.85% above the general inflation rate. Let us calculate present worth for the 30 years of costs in the schedule.

Therefore,

$$e = 2.8\% \text{ (0.1\% less than the general inflation rate 2.9\%)}$$

$$i = 6.75\% \text{ (3.85\% above the general inflation rate of 2.9\%)}, \text{ and}$$

$$n = 30 \text{ years.}$$

From these we can calculate:

$$a = \frac{0.0675 - 0.0280}{1 + 0.0280}$$

$$= 0.0384$$

$$= 3.84\%$$

$$P_f = \frac{1 - (1 + 0.0384)^{-30}}{0.0384}$$

$$= 17.6$$

$$PW = \$500 \times 17.6$$

$$= \$8800$$

Therefore, if \$8,800 were put in a bank now at 6.75% interest and used to pay for the above schedule of heating costs, it would be used up in 30 years.

We can now apply this present-worth concept to the process of deciding on minimum requirements for an energy code. Suppose we are considering a range of thermal transmittance values for walls; suppose too that we know the construction cost increment of each wall type relative to the cost of constructing the wall with the highest thermal transmittance. We can calculate the heating cost increment that each type of wall produces in a representative building relative to the heating cost of the same representative building with the wall type with the lowest thermal transmittance. If we then apply the present-worth approach to the heating cost increments and calculate the total life-cycle cost for each thermal transmittance level, the results might look like Table F-1 and its accompanying graph (Figure F-1):

Thus, U-value 0.256 has the lowest life-cycle cost. However, other U-values have almost the same life-cycle cost. A provincial or territorial authority that was particularly concerned about the cost of construction might choose to make U-value 0.286 the required maximum, since this would save \$3/m<sup>2</sup> without significantly affecting the life-cycle cost. On the other hand, a provincial or territorial authority that was particularly concerned about saving energy might choose to make U-value 0.233 the required maximum, since this would reduce heating costs by about \$0.30/m<sup>2</sup> per year or \$5.70/m<sup>2</sup> on a life-cycle basis, again without significantly affecting the life-cycle cost. Another consideration might be that a U-value higher than the theoretical optimum might be more consistent with the typical construction practices and available materials in a particular province or territory.

**Table F-1  
Life-cycle Cost of Wall Options**

U, m <sup>2</sup> ·°C/W	Construction Cost Increment, \$/m <sup>2</sup> of wall	Heating Cost Increment, \$/m <sup>2</sup> of wall	Present-Worth Factor	Present Worth of Heating Costs, \$/m <sup>2</sup> of wall	Total Life-Cycle Cost, \$/m <sup>2</sup> of wall
0.476	0	2.5	17.6	43.2	43.2
0.370	5	1.7	17.6	29.2	34.2
0.323	8	1.3	17.6	22.9	30.9
0.286	10	1.0	17.6	18.0	28.0
0.256	13	0.8	17.6	14.1	27.1
0.233	17	0.6	17.6	11.0	28.0
0.213	20	0.5	17.6	8.4	28.4
0.196	24	0.4	17.6	6.2	30.2
0.182	27	0.2	17.6	4.3	31.3
0.149	33	0.0	17.6	0.0	33.0

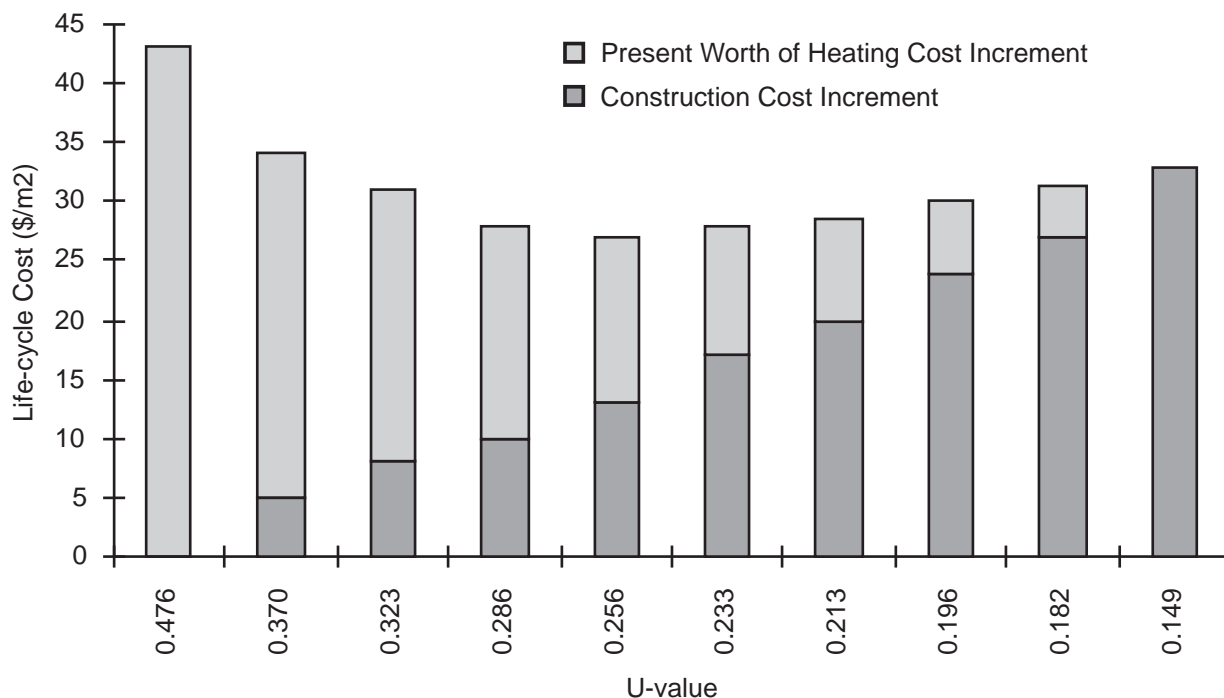

**Figure F-1  
Life-cycle cost of wall options**

One more factor in Table F-2 of provincial/territorial assumptions requires further explanation. The procedure was established with provision for an “environmental multiplier.” This is a factor that can

be applied to energy costs to reflect the fact that current market energy costs do not necessarily reflect the full impact of the use of energy on the environment (e.g., carbon dioxide emissions from

## Appendix F

the burning of oil or natural gas). One of the principal impetuses for using codes to regulate the energy-related characteristics of buildings is the desire to reduce the effect of energy use in the heating, cooling and lighting of buildings on the environment; but simply basing the life-cycle costing process described herein on the market costs of energy may not adequately address this concern. The environmental multiplier factor can also be used to allay concerns that this process may not adequately reflect the benefits to future generations provided by saving energy today. In any case, assigning a

value to this factor is difficult and, as is evident in Table F-2, all provinces and territories but one have chosen to leave this factor at a value of 1.0, at least for this edition of the Code.

Hopefully, this provides a rough understanding of the kind of cost/benefit analysis process on which this Code's regionally sensitive requirements are based and the kind of judgmental adjustments of that process's results that are sometimes necessary.

**Table F-2**  
**Provincial/Territorial Assumptions for Life-Cycle Costing**

Province/Territory	General Inflation Rate	Discount Rate (not including inflation)	Economic Life (years)	Environmental Multiplier	Energy Cost (\$/GJ)			Energy Escalation Rate (not including inflation)		
					Electricity	Oil	Natural Gas, Propane	Electricity	Oil	Natural Gas, Propane
Yukon <sup>(1)</sup>	3%	6%	30	1.0	31.81	9.31	14.02 (Propane)	0%	0%	0%
Northwest Territories <sup>(2)</sup>	3%	6%	30	1.0	38.89	9.36	10.58	0%	0%	0%
British Columbia <sup>(1)</sup>	<sup>(3)</sup>	6%	30	1.0	14.30	6.09	5.20	0.5%	1.0%	1.2%
Alberta	3%	6%	30	1.0	19.11	10.05 (Propane)	2.91	-0.06%	1.74% (Propane)	4.03%
Saskatchewan	3%	6%	30	1.0	25.42	-	3.98	0%	-	1.5%
Manitoba	3%	6%	30	1.1	15.80	7.55	4.96	-1.45%	0.88%	1.78%
Ontario	3%	6%	30	1.0	20.98	5.94	4.26	0.4%	1.5%	1.5%
Quebec	3%	6%	30	1.0	17.53	9.46	9.23	0%	0%	0%
New Brunswick	3%	6%	30	1.0	18.84	6.46	16.45	0%	0.5%	0.5%
Nova Scotia	3%	6%	30	1.0	27.75	6.33	12.57	-0.1%	0.4%	0.4%
Prince Edward Island	3%	6%	30	1.0	30.70	9.26	15.08	-0.1%	0.4%	0.4%
Newfoundland <sup>(1)</sup>	3%	6%	30	1.0	27.94	6.06	-	1.0%	1.0%	-

### Notes to Table F-2:

(1) Prices vary by zone; prices shown are for Zones A, which include Whitehorse (Yukon), Vancouver (BC), and St. John's (Nfld).

(2) Prices vary by zone; prices shown are for Zone B, which includes Yellowknife.

(3) Constant dollar analysis.

### Adjustments Made to the Life-Cycle Cost Analyses Results by the Standing Committee on Energy Conservation in Buildings

- **Floors on ground incorporating heating elements.** Although the life-cycle cost results, in some cases, indicated that perimeter insulation of heated floors on ground was more cost-effective than full-surface insulation, the Standing Committee decided to require full-surface insulation in all cases because
  - (a) the available methods for calculating below-grade heat loss cannot be applied to heated floors with confidence, and
  - (b) full-surface insulation is standard industry practice.
- **Consolidation of Wall Types.** Life-cycle cost analyses were carried out for three types of walls — metal-frame insulated with fibrous insulation, wood-frame insulated with fibrous insulation, and all others (concrete block, sheet steel, et al). Obviously, the results of such analyses are likely to be different for different types of walls. Thus, a code based on this approach will have different requirements for different types of construction. The Standing Committee chose this approach in order to avoid the Code's having a significant impact on basic building design choices. If the Committee had chosen, for example, to have one set of maximum U-values for walls and had based those U-values on life-cycle costing for a type of wall construction for which it is relatively easy to achieve low U-values, it could have had the effect of totally eliminating the possibility of using other types of construction for which it is more difficult to achieve low U-values; the permitted maximum U-values would be unattainable for these types of construction. On the other hand, if the Committee had chosen to base the maximum U-values on life-cycle costing for a type of wall for which it is relatively difficult to achieve low U-values, the results would be well below what could be economically achieved with other types of walls. Concern has been expressed that this approach could lead to just the effect it is trying to avoid. It has been suggested that the differences in U-value requirements between component types may have enough impact on the relative costs of different types of components to affect design/purchase decisions. The Standing Committee considered this possibility but found that the differences in cost imposed by the differences in required U-values were much less significant than the factors that cause a designer to choose one type of construction over another, which include cost but also several other factors such as durability and aesthetics. For example, for Ontario Zone A and gas heating, the first public review draft of the

Model National Energy Code for Buildings (MNECB) imposed a maximum U-value of  $0.41 \text{ W/m}^2\cdot^\circ\text{C}$  for masonry walls and  $0.51 \text{ W/m}^2\cdot^\circ\text{C}$  for steel-framed walls. The cost data available to the committee indicated that a masonry wall that would satisfy the less stringent requirement for steel-framed walls would have a cost premium of  $\$86.40/\text{m}^2$  over a steel-framed wall that would also satisfy that requirement, and that the added cost of upgrading the masonry wall to satisfy the more stringent U-value requirement would only be  $\$1.08/\text{m}^2$ . Nevertheless, in reviewing public comment and preparing for a second public review draft, the Standing Committee decided to consolidate the wall categories in the MNECB and permit the same maximum U-value for all types, based on the wall type with the highest U-value resulting from the life-cycle analyses. This decision was based on a review of the life cycle cost results, which indicated that:

- the low points on the life-cycle cost curves for all wall types fall within a fairly narrow band of U-values;
- the life-cycle cost curves for all wall types are quite flat in the vicinities of their low points, meaning that the optimum choice for each type is not clearly defined.

This is not the case with roofs. The low points on the life-cycle cost curves are significantly different for the three types of roofs analyzed.

- **Accounting for Finishing Materials in the Life-cycle Cost Analyses.** In many circumstances, some types of walls are often left unfinished; e.g. solid or single-wythe masonry walls often have no interior or exterior finish added when used in warehouse and light industrial buildings. Foundation walls may or may not have an interior finish added, depending on how the space they enclose is used. With such walls, it is necessary to add either an exterior or interior finish to accommodate any significant amount of insulation; e.g. an exterior wythe to create a cavity wall or interior finish on framing. Where such a finish would not otherwise be used, its cost must be added to the cost of the insulation for the purpose of life-cycle cost analysis. This will result in higher optimum U-values, which is why the tables in Appendix A include a category for unfinished solid masonry walls. Where such walls are permitted, it indicates, for that particular combination of climate and energy source, that the cost of adding finish to accommodate more insulation was found not to be cost-effective. Similar reasoning applies in the tables to the category of unfinished foundation walls.

---

## **Appendix F**

### **References**

- (1) Swinton, M.C.; Sander, D.M., A Method for Life Cycle Cost Analysis for the New Energy Code for Houses, Innovative Housing '93 Conference, Vancouver, 1993. Vol. 2, pp. 278–284, (NRCC-35223) (IRC-P-3091).
- (2) Specification for Calculation Procedures for Life-Cycle Cost Analysis for the Canadian Code for Energy Efficiency in New Houses, Canadian Commission on Building and Fire Codes, National Research Council Canada, Ottawa, 1993.
- (3) Development of a Database of Construction Costs of Opaque Envelope Components for Use in the Development of the Energy Code — Residential Construction, Energy Building Group Ltd., for Building Performance Laboratory, Institute for Research in Construction, National Research Council Canada, Ottawa, 1993.

# Appendix G

## Conversion Factors

Table G-1  
Conversion Factors

To convert	To	Multiply by	Notes
°C	°F	1.8 and add 32	
L	gal (imperial)	0.2200	
L	US gal	0.2642	
L/s	ft <sup>3</sup> /min (cfm)	2.1189	ft = foot, min = minute
lx	ft-candle	0.09290	
m	ft	3.281	
m <sup>2</sup>	ft <sup>2</sup>	10.76	
m <sup>2</sup> ·°C/W (RSI)	h·ft <sup>2</sup> ·°F/Btu (R)	5.678	Thermal Resistance
m <sup>3</sup>	ft <sup>3</sup>	35.31	
mm	in.	0.03937	in. = inch
Pa	in. of water	0.004014	
W	Btu/h	3.413	
W/m <sup>2</sup>	Btu/h·ft <sup>2</sup>	0.3170	
W/m <sup>2</sup> ·°C	Btu/h·ft <sup>2</sup> ·°F	0.17612	U-value
W/m·°C (per m thickness)	Btu·ft/h·ft <sup>2</sup> ·°F	0.5777	Conductivity (per ft)
	Btu·in/h·ft <sup>2</sup> ·°F	6.9444	Conductivity (per in.)
W/L	BTU/h·USgal	12.916	